

MESSRS 深圳市东信工电子技术有限公司

SPECIFICATION

STACKED TYPE -
METALLIZED POLYESTER FILM CAPACITOR

TYPE MMT, MMTF, MMTC, MMTV, MMTS - 50, 63, 100, 250V. DC

DRAWING No. PSC401000

PLEASE RETURN 1 COPY WITH RECEIVED STAMP.

DATE June 30, 2017

DESIGNED Y. Ootashiro

CHECKED N. Obara

APPROVED H. Kawagoe

NISSEI ELECTRIC CO., LTD.

No. 170074



安全に関する注意

コンデンサを使用するに当たり、使用環境、及び取り付け環境を確認の上、納入仕様書に規定した定格性能の範囲内でご使用下さい。

納入仕様書、添付注意事項の範囲を越えて使用しますと、ショート、オープン、発煙、発火に至る場合がありますので、定格性能の範囲内であることを確認願います。

尚、納入仕様書に記載のない項目、不明な内容については、必ずお問い合わせ下さい。

又、生命に影響を与える可能性がある装置、機器（生命維持装置、航空機用制御装置、自動車用制御装置等）に使用される場合にも必ずお問い合わせ下さい。

※本仕様書は、発行日より6ヶ月を経過して返却されなかった場合は、受領いただけなかったものと判断し、無効とさせていただきます事ご了承願います。



Cautions About Safety In Use of Capacitors

When using a capacitor, please use one within the range of values specified in the specification after checking the environments of using and mounting.

If used beyond the range specified in the specification or the attached cautions, it may lead to short circuit, open, smoking and firing.

Be sure to inquire of us as to the items which are not specified in the specification or are unclear to you.

Also, in case of using capacitors for such equipment or apparatus as may possibly affect human lives like life-support system, aircraft and automotive control systems, etc., please never fail to inquire of us as to further details.

If this specification is not returned within six months, we consider it not to be accepted by you and will make it null and void.

SPECIFICATION	STACKED TYPE - METALLIZED POLYESTER FILM CAPACITOR	SPEC No. P S C 4 0 1 0 0 0																					
<p>1. SCOPE</p> <p>This specification defines general requirements for Stacked type metallized polyester film capacitor MMT type (hereinafter called capacitor).</p> <p>2. PARTS NUMBER CODE SYSTEM</p> <table border="1" data-bbox="188 584 1485 645"> <tr> <td>M</td><td>M</td><td>T</td><td></td> <td>*</td> <td>0</td><td>0</td><td>5</td><td>0</td> <td>J</td> <td>1</td><td>0</td><td>4</td> <td>0</td><td>0</td><td>0</td><td>0</td> <td>0</td><td>0</td><td>0</td><td>0</td> </tr> </table> <p style="text-align: center;"> ① ② ③ ④ ⑤ ⑥ ⑦ </p> <p>①Designation</p> <p>MMT : Straight lead type MMTF : Single-formed lead type MMTD : Double-formed lead type MMTC : Cutted lead type MMTV : Automatic vertical insersion type (Formed lead type) MMTS : Automatic vertical insersion type (Straight lead type)</p> <p>②Suffix</p> <p>③Rated DC voltage 50 , 63 , 100 , 250 V.DC</p> <p>④Tolerance on capacitance J : ± 5 %</p> <p>⑤Capacitance Code</p> <p>Capacitance value shall be given by 3-digit figure of which unit used is expressed in pF. The first 2 digits are significant figures of the capacitance value, the third digit to indicate the number of additional zeros to follow the significant figure.</p> <p>⑥Model code</p>			M	M	T		*	0	0	5	0	J	1	0	4	0	0	0	0	0	0	0	0
M	M	T		*	0	0	5	0	J	1	0	4	0	0	0	0	0	0	0	0			
		<table border="1"> <thead> <tr> <th data-bbox="869 1892 1233 1928">SIGNATURE</th> <th data-bbox="1233 1892 1501 1928">DATE</th> </tr> </thead> <tbody> <tr> <td data-bbox="869 1928 1233 1995">DESIGNED <i>Y. Aotashiro</i></td> <td data-bbox="1233 1928 1501 1995"><i>November 22, 2016</i></td> </tr> <tr> <td data-bbox="869 1995 1233 2063">CHECKED <i>H. Obara</i></td> <td data-bbox="1233 1995 1501 2063"><i>November 22, 2016</i></td> </tr> <tr> <td data-bbox="869 2063 1233 2130">APPROVED <i>H. Kawagoe</i></td> <td data-bbox="1233 2063 1501 2130"><i>November 22, 2016</i></td> </tr> </tbody> </table>	SIGNATURE	DATE	DESIGNED <i>Y. Aotashiro</i>	<i>November 22, 2016</i>	CHECKED <i>H. Obara</i>	<i>November 22, 2016</i>	APPROVED <i>H. Kawagoe</i>	<i>November 22, 2016</i>													
SIGNATURE	DATE																						
DESIGNED <i>Y. Aotashiro</i>	<i>November 22, 2016</i>																						
CHECKED <i>H. Obara</i>	<i>November 22, 2016</i>																						
APPROVED <i>H. Kawagoe</i>	<i>November 22, 2016</i>																						

SPECIFICATION

STACKED TYPE -
METALLIZED POLYESTER FILM CAPACITOR

SPEC No.

P S C 4 0 1 0 0 0

⑦Lead dimension / Packing mode

Designation	Code	
MMT	0 0 0 0	
MMT F	Code	Lead spacing
MMT D	0 0 5 0	5. 0mm
MMT C	0 0 5 0	
MMT V	0 2 0 0	
MMT S	0 2 0 0	

3. RATING

3.1 Operating Temperature Range : Operating temperature range to capacitors shall be $-40^{\circ}\text{C}\sim+105^{\circ}\text{C}$ (Voltage derating in case of over 85°C).

3.1.1 Maximum Operating Temperature : Maximum value of capacitor's surface temperature (ambient temperature+self heating temperature rise+radiation and conduction heat from other electric supply sources) at which capacitors shall be capable of applying continuously.

3.1.2 Minimum Operating Temperature : Minimum temperature range at which capacitors shall be capable of applying continuously.

3.2 Rated Voltage : The rated voltage shall be continuously usable within a working temperature range, and there are 4 kinds of rated voltages - 50, 63, 100, 250V.DC.

However, in the $+85^{\circ}\text{C}$ to $+105^{\circ}\text{C}$ range, there is the need for voltage derating of $1.5\% / ^{\circ}\text{C}$ as shown in the following graph.

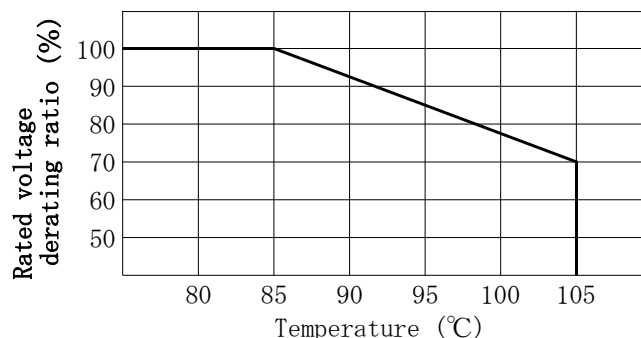

3.3 Capacitance range

50V. DC	0.010	~	3.3 μF	E-12
63V. DC	0.010	~	3.3 μF	E-12
100V. DC	0.010	~	1.0 μF	E-12
250V. DC	0.010	~	0.22 μF	E-12

3.4 Tolerance on capacitance
 $\pm 5\%$

SPECIFICATION

STACKED TYPE -
METALLIZED POLYESTER FILM CAPACITOR

SPEC No.

P S C 4 0 1 0 0 0

4. CONSTRUCTION OF CAPACITOR

An element of this type has a non-inductive construction where metallized polyester film is stacked, and leads of a capacitor are connected to an element.

As an outer coating resin, an epoxy resin is used in order to prevent moisture absorption and to give insulation treatment.

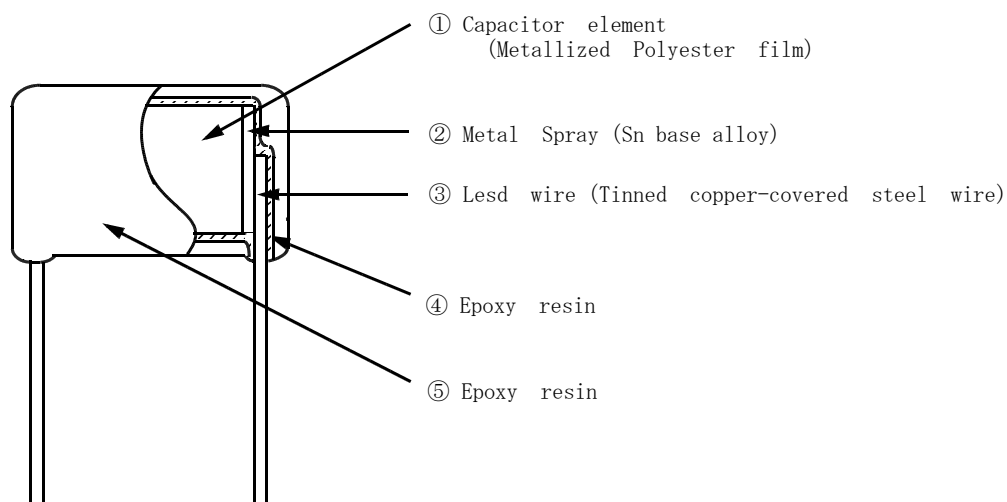

5. DIMENSIONS

Dimensions are specified in the attached sheet.

SPECIFICATION

STACKED TYPE -
METALLIZED POLYESTER FILM CAPACITOR

SPEC No.

P S C 4 0 1 0 0 0

6. MARKING

6.1 Marking item

The capacitors shall be marked clearly by an indelible way.

1) Nominal capacitance

Shall be marked with 3-digit code. Example) 333 , 104

2) Production date code

Month Year	1	2	3	4	5	6	7	8	9	1 0	1 1	1 2
Odd year	A	B	C	D	E	F	G	H	Φ	Θ	L	Σ
Even year	N	P	Q	R	S	T	U	V	W	X	Y	Z

3) Manufacturer's Identification

Ⓝ (For capacitance in the 0.010 to 0.33 μ F range of 50 and 63V.DC, and 100 and 250V.DC, the name of manufacturer will be omitted.)

※ Tolerance on rated capacitance and rated DC voltage shall be omitted.

6.2 Marking position

(Example)

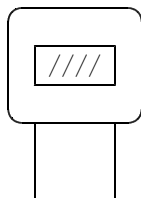

	Cap 103~334	Cap 394~335
50V.DC	1 0 4 A	1 0 5 Ⓝ A
63V.DC	1 0 4 <u>A</u>	1 0 5 Ⓝ <u>A</u>
100V.DC	1 0 <u>4</u> A	
250V.DC	1 <u>0</u> 4 A	

SPECIFICATION	STACKED TYPE - METALLIZED POLYESTER FILM CAPACITOR	SPEC No. P S C 4 0 1 0 0 0
---------------	---	-----------------------------------

7. PACKING

- 1) Straight leads, formed leads, double formed leads and cutted leads type.
The capacitors shall be put in poly-bag and packed in box marked with necessary information.

Inside packing case

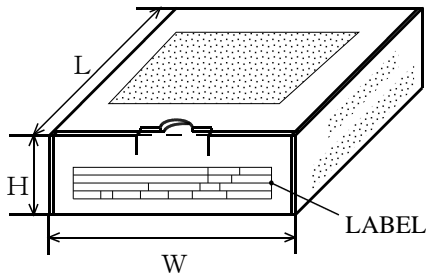

Dimension (mm)

W	L	H
1 9 8	1 7 6	7 4

External packing case

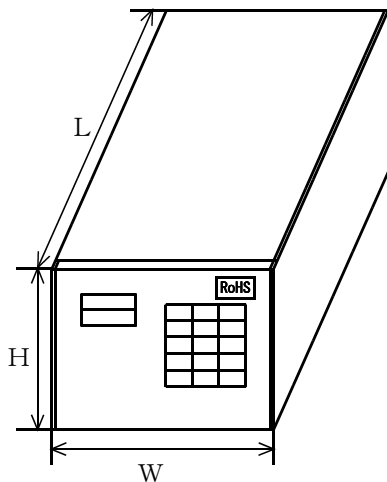

Dimension (mm)

Inside packing case quantity	W	L	H
2	1 6 5	2 1 0	2 0 0
4	2 1 0	3 1 0	"
6	2 3 5	4 1 0	"
8	3 1 0	4 1 0	"
1 2	4 1 0	4 5 0	"

Example)

CODE CUSTOMER				INSP DATE		PKG NO	
①				②			
PARTS NO				MACH NO		QTY/PKG	
③				④			
ORDER NO			LOT NO			ROHS	
⑤			⑥			⑦	
TYPE	WV	TOL	CAP	EDP CODE		QT (PCS)	
⑧	⑨	⑩	⑪	⑫		⑬	

- | | | | |
|----------------|-----------|---------------------|-----------|
| ①CODE CUSTOMER | ④MACH NO | ⑦PRODUCTION COUNTRY | ⑩TOL (%) |
| ②INSP DATE | ⑤ORDER NO | ⑧TYPE | ⑪CAP |
| ③PARTS NO | ⑥LOT NO | ⑨W V | ⑫EDP CODE |
| | | | ⑬QT (PCS) |

- 2) Automatic vertical insertion type.
This is specified by the specification of automatic vertical insertion type.

SPECIFICATION	STACKED TYPE - METALLIZED POLYESTER FILM CAPACITOR	SPEC No. P S C 4 0 1 0 0 0
<p>8. APPLICABLE STANDARD Unless otherwise specified, performance and a testing method shall comply with JIS C 5101-1:2010.</p> <p>9. DISUSE OF O.D.C. No ozone depleting chemicals are used at any stage of the manufacturing process.</p> <p>10. DISUSE OF PBB0, PBDPO, PBDPE, PBBs This products does not contain PBB0, PBDPO, PBDPE, PBBs.</p> <p>11. CERTAIN HAZARDOUS SUBSTANCES RESTRICTED BY RoHS DIRECTIVE In the product, materials to which certain hazardous substances restricted by RoHS Directive (2011/65/EU) (cadmium, hexavalent chromium, mercury, lead, PBB and PBDE) are added on purpose aren't used.</p> <p>12. PRODUCTION COUNTRY • JAPAN • CHINA</p> <p>Production country shall be distinguished in the colum ⑦.</p> <p>Example) JP : JAPAN blank : CHINA</p>		

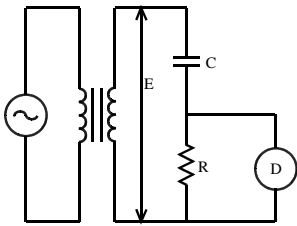
SPECIFICATION		STACKED TYPE - METALLIZED POLYESTER FILM CAPACITOR	SPEC No. P S C 4 0 1 0 0 0
1 3 . CHARACTERISTICS AND TEST CONDITIONS			
13.1 TEST CONDITIONS			
The test and measurement, unless otherwise specified, the standard range of atmospheric conditions of marking measurements and test is as follows			
Ambient temperature : 5 to 35°C			
Relative humidity : 45 to 85%			
If there may be anydoubt on the results, measurements shall be made within the following limits.			
Ambient temperature : 20±2°C			
Relative humidity : 60 to 70%			
13.2 Electrical characteristics test			
Item	Characteristics	Test conditions	
Dielectric strength	Between terminations	No breakdown. However momentary breakdown is permissible.	Capacitors shall withstand 150% of rated DC voltage for 1 minute or 175% of rated DC voltage for 1~5 seconds. (Charge or discharge current : 1A max)
	Between terminations and case	No breakdown.	Capacitors shall withstand 200% of rated DC voltage for 1~5 seconds.
Insulation resistance (Between terminations)	$C \leq 0.33 \mu F$ 3,000M Ω or more	DC voltage specified below shall be applied for 1 minute, after which measurement shall be made.	
	$C > 0.33 \mu F$ 1,000M Ω or more	Rated voltage	Test voltage
Capacitance	Within the nominal tolerance.	50, 63V.DC	50V.DC
Tangent of loss angle	0.01 or less	100, 250V.DC	100V.DC
Connection of element	There shall be no intermittent contacts or open circuiting which would result in any needle deflection on the voltage detector.	<p>As in the diagramed circuit measure the variation of terminal voltage for the series resistor(R) while a weak impact is made on the test capacitor to check the bonding strength of the terminals to the capacitor.</p>  <p>C : Capacitor R : Series resistor $R(\Omega) = 150/C(\mu F)$ C=Nominal capacitance μF Ⓧ : Detector Internal impedance shall be large enough as compared with c. E : 100mV (peak value) Max at 10k~1MHz</p>	

SPECIFICATION		STACKED TYPE - METALLIZED POLYESTER FILM CAPACITOR	SPEC No. P S C 4 0 1 0 0 0
13.3 Mechanical characteristics test			
Item		Characteristics	Test conditions
Termination strength	Tensile strength	Without mechanical damage, such as break of terminal damage.	Test capacitors shall be fixed, and unless otherwise specified, a tensile force of 10N shall be gradually applied to the axial of the leads, and then maintained for 30 ± 5 seconds.
	Bending strength		The bend test shall consist of hanging a weight of 5N to the end of the leads and then rotating the capacitors 90° in one direction, then to the starting point. This test shall be applied for 2.5 seconds per each time. At the same test speed, the capacitors shall be rotated 90° in alternating direction, then return to the starting point.
Vibration resistance		No electrical discontinuity such as opening, short-circuit of 0.5ms or more. Also, no abnormality on appearance after test.	Capacitors shall be capable of withstanding without malfunctioning such as short, open circuit or a damage to a vibration test in three directions against perpendicularity at a frequency range from 10Hz to 55Hz. The frequency shall be varied uniformly from 10Hz to 55Hz at 1.5mm amplitude and back to 10Hz in approximately 1 minute intervals.
Solderability		At least 90% of the circumferential face of termination up to immersed level shall be covered with new solder.	Capacitor's leads shall be immersed into Flux (10% rosin) for 5~10 seconds using sheltering board from radial test, then immersed into soldering bath at $245\pm 5^\circ\text{C}$ for 2 ± 0.5 seconds up to the depth of 1.5~2mm from the bottom of the body. Immersed and removing speed shall be $25\pm 2.5\text{mm/sec}$.

SPECIFICATION		STACKED TYPE - METALLIZED POLYESTER FILM CAPACITOR	SPEC No. P S C 4 0 1 0 0 0
Item		Characteristics	Test conditions
Resistance to soldering heat	Appearance	No visible damage.	Using sheltering board from the radial heat, capacitor's leads shall be immersed into soldering bath at $260\pm 5^{\circ}\text{C}$ for 10 ± 1 seconds up to the depth of 1.5~2mm from the bottom of the body. The capacitors shall withstand 150% of rated DC voltage for 1 minute.
	Dielectric strength (Between terminations)	No breakdown.	
	Capacitance change	Within $\pm 3\%$ of the initial value.	
Solvent resistance	Marking	The Marking shall be legible.	The capacitor shall be completely submerged stationarily in the isoprorylalcohol for 30 ± 0.5 seconds, and taken out. After which its appearance and marking shall be visually observed.
	Appearance	No visible damage.	
13.4 Climatic test			
Item		Characteristics	Test conditions
Cold	Capacitance change	Within $+0, -7\%$ of the initial value.	Measured at $-40\pm 2^{\circ}\text{C}$.
Dry heat	Insulation resistance	$C \leq 0.33 \mu\text{F}$ ----- $600\text{M}\Omega$ or more $C > 0.33 \mu\text{F}$ $200\Omega\text{F}$ or more	Measured at $85\pm 2^{\circ}\text{C}$.
	Capacitance change	Within $+5, -2\%$ of the initial value.	
Humidity resistance (steady state)	Appearance	No visible damage.	The capacitor shall be put into the test chamber and left under the condition of relative humidity 90~95% at $40\pm 2^{\circ}\text{C}$ for 500 ± 24 hours. After the test, the capacitor shall be left under the ordinally condition for 1~2 hours. The capacitors shall withstand 130% of rated DC voltage for 1 minute.
	Dielectric strength (Between terminations)	No breakdown.	
	Insulation resistance	$C \leq 0.33 \mu\text{F}$ ----- $100\text{M}\Omega$ or more $C > 0.33 \mu\text{F}$ $30\Omega\text{F}$ or more	
	Tangent of loss angle	0.011 or less	
	Capacitance change	Within $\pm 7\%$ of the initial value.	

SPECIFICATION		STACKED TYPE - METALLIZED POLYESTER FILM CAPACITOR	SPEC No. P S C 4 0 1 0 0 0															
Item	Characteristics	Test conditions																
Endurance test for humidity	Appearance	No visible damage.																
	Dielectric strength (Between terminations)	No breakdown.																
	Insulation resistance	$C \leq 0.33 \mu F$ $100M\Omega$ or more	The rated voltage shall be continuously applied to the capacitor in the test chamber at a relative humidity of 90~95% at $40 \pm 2^\circ C$ for $500 \pm 2\%$ hours. After the test, the capacitor shall be left under the ordinally condition for 1~2 hours. The capacitors shall withstand 130% of rated DC voltage for 1~5 seconds. The load resistor in series with the capacitor shall be 20~1,000 Ω .															
		$C > 0.33 \mu F$ 30 ΩF or more																
	Tangent of loss angle	0.011 or less																
Capacitance change	Within $\pm 7\%$ of the initial value.																	
Endurance test for high temperature	Appearance	No visible damage.																
	Insulation resistance	$C \leq 0.33 \mu F$ 1,000M Ω or more	The voltage of 125% of rated voltage shall be continuously applied to the capacitor through a series of 20~1,000 Ω per 1 voltage in the test chamber at $85 \pm 3^\circ C$ for $1,000 \pm 4\%$ hours.															
		$C > 0.33 \mu F$ 300 ΩF or more																
	Tangent of loss angle	0.01 or less																
Capacitance change	Within $\pm 7\%$ of the initial value.																	
Rapid change of temperature	Appearance	No visible damage.																
	Insulation resistance	$C \leq 0.33 \mu F$ 1,000M Ω or more	The capacitors shall be maintained in following temperature the table.1 for 5 cycles. Table.1															
		$C > 0.33 \mu F$ 300 ΩF or more																
	Tangent of loss angle	0.01 or less																
Capacitance change	Within $\pm 5\%$ of the initial value.																	
<table border="1"> <thead> <tr> <th>Step</th> <th>Temperature</th> <th>Maintained time</th> </tr> </thead> <tbody> <tr> <td>1</td> <td>$-40 \pm \frac{0}{3}^\circ C$</td> <td>30 ± 3 min</td> </tr> <tr> <td>2</td> <td>room temperature</td> <td>3Min max</td> </tr> <tr> <td>3</td> <td>$+85 \pm \frac{3}{0}^\circ C$</td> <td>30 ± 3 min</td> </tr> <tr> <td>4</td> <td>room temperature</td> <td>3Min max</td> </tr> </tbody> </table>				Step	Temperature	Maintained time	1	$-40 \pm \frac{0}{3}^\circ C$	30 ± 3 min	2	room temperature	3Min max	3	$+85 \pm \frac{3}{0}^\circ C$	30 ± 3 min	4	room temperature	3Min max
Step	Temperature	Maintained time																
1	$-40 \pm \frac{0}{3}^\circ C$	30 ± 3 min																
2	room temperature	3Min max																
3	$+85 \pm \frac{3}{0}^\circ C$	30 ± 3 min																
4	room temperature	3Min max																

14. Failure ratio (Short or open circuit)

The level of failure ratio in the above high temperature endurance test shall be less than 0.5%/1,000hours. But, the calculation of failure ratio is according to JIS C 5003 (reliable level : 60% and component time : 1,000,000 hours.)

SPECIFICATION

STACKED TYPE -
METALLIZED POLYESTER FILM CAPACITOR

SPEC No.

P S C 4 0 1 0 0 0

15. REGULATION IN USAGE

15.1 Voltage derating for frequency

15.1.1 A.C. maximum operating voltage in case of operating with commercial frequency (50 or 60Hz) is as shown in the table below. However, it can not be used for "Across-the-line" application.

Rated voltage	A. C. maximum operating voltage
50 V. DC	30 V r m s
63 V. DC	40 V r m s
100 V. DC	63 V r m s
250 V. DC	125 V r m s

15.1.2 When containing a portion of D.C. Bias, the crasy value (peak voltage V_{o-P}) waveform shall not exceed the rated voltage.

15.2 Permissible current to frequency

A permissible current is regulated by both a root-mean-square value current and a peak current. A root-mean-square value current is to be a permissible current value to frequency attached. A permissible peak current is determined by a permissible peak current value attached.

The values of continuous peak current in the allowable peak current shall be those of continuous current, and the values of single peak current shall be those of discontinuous current such as rush current in switching on or off. The highest number of times of single peak current shall be limited to 10,000 times. (In case of exceeding 10,000 times, please contact us.)

15.3 Permissible current to temperature

When operating in the range of $+85^{\circ}\text{C}\sim+105^{\circ}\text{C}$ with waveform except direct current, the value for characteristic of permissible current to frequency shown in Fig. shall be derated 1.5% at each 1°C .

SPECIFICATION

STACKED TYPE -
METALLIZED POLYESTER FILM CAPACITOR

SPEC No.

P S C 4 0 1 0 0 0

15.4 Soldering

When soldering a capacitor, be sure to solder within the following temperature range.

(1) Flow soldering

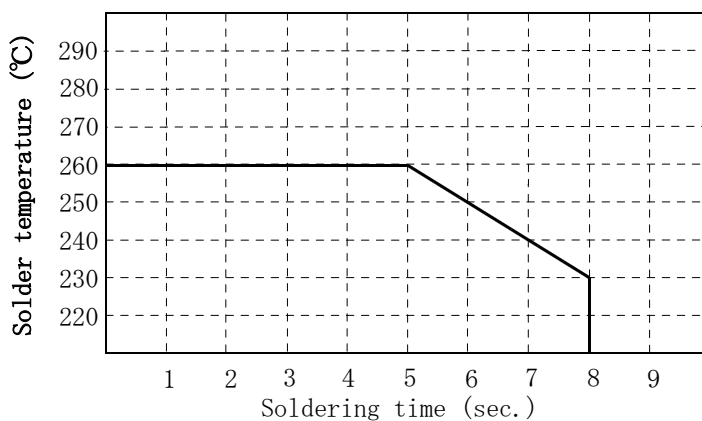

Preheating condition : 120°C,
for one minute

(2) When using soldering iron

Iron tip temperature less than 350°C
Soldering time (sec.) within 5 seconds

- (3) When soldering a capacitor mounted on the board with chip-type components
In case that the curing heat is applied for fixing the chip components,
the temperature and time shall be within the following range.

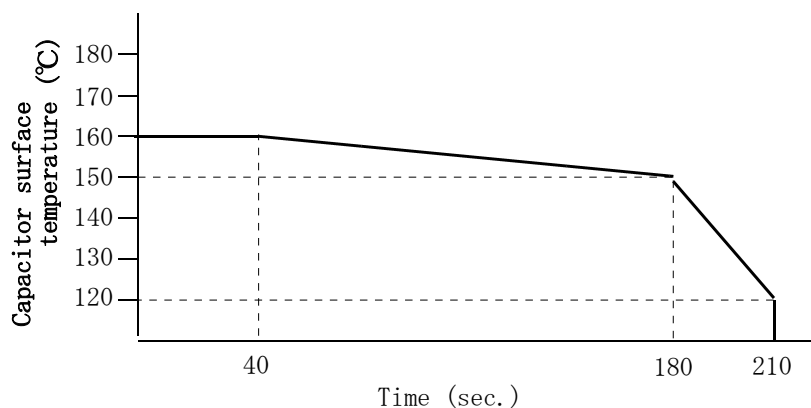

周波数に対する許容電流特性 (正弦波)

CHARACTERISTICS OF PERMISSIBLE CURRENT TO FREQUENCY (SINUSOIDAL WAVE)

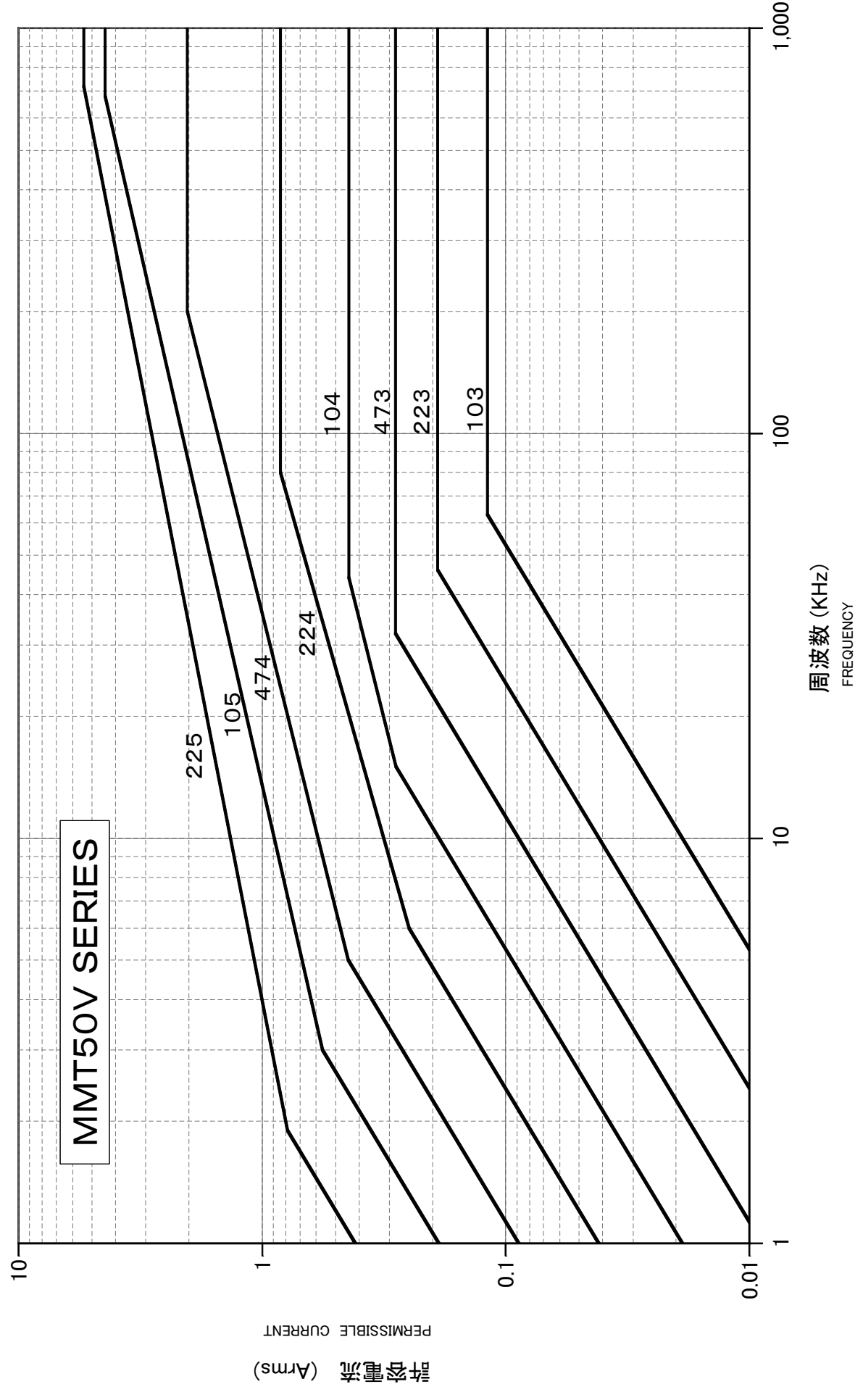

周波数に対する許容電流特性 (正弦波)

CHARACTERISTICS OF PERMISSIBLE CURRENT TO FREQUENCY (SINUSOIDAL WAVE)

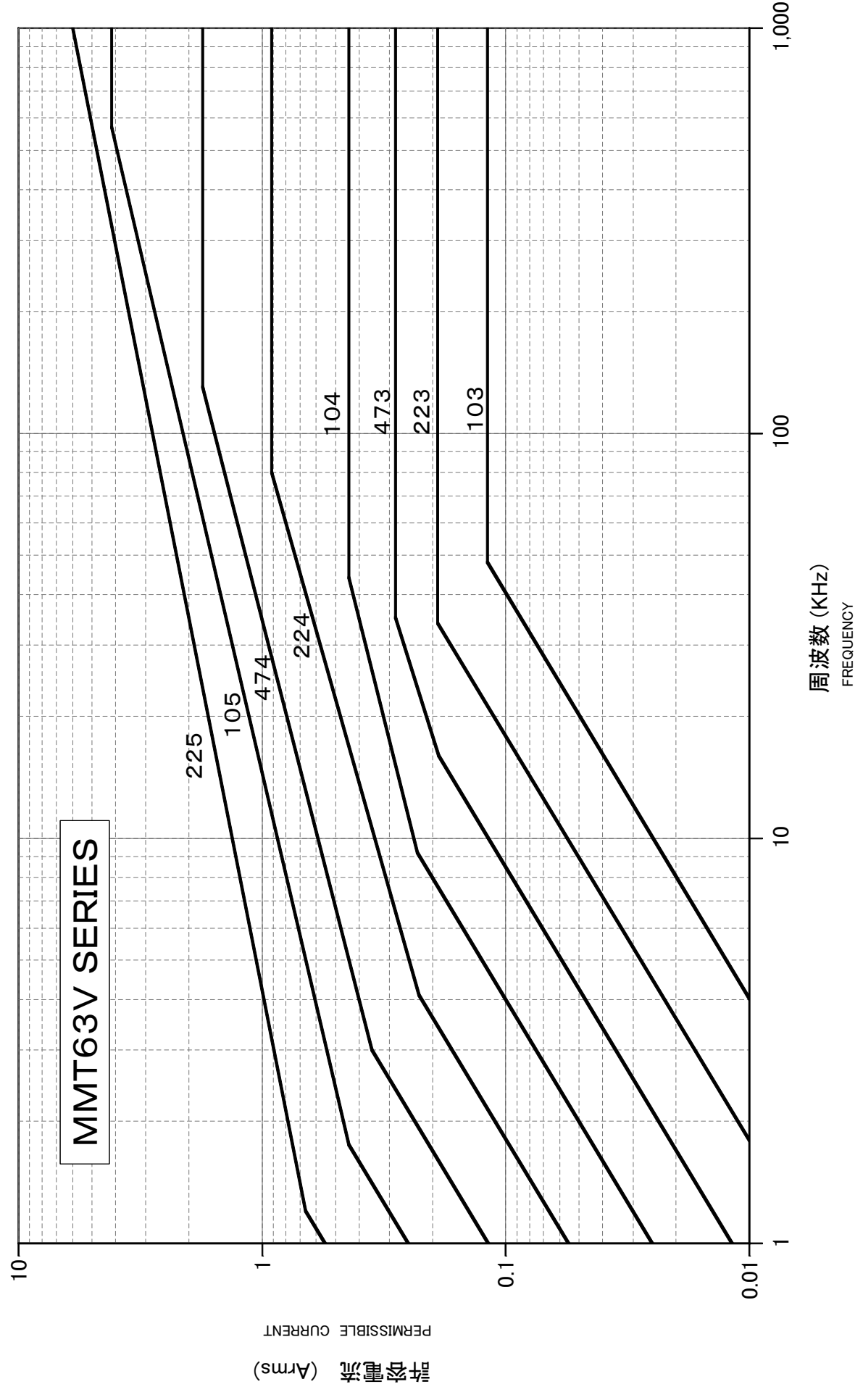

周波数に対する許容電流特性

CHARACTERISTICS OF PERMISSIBLE CURRENT TO FREQUENCY

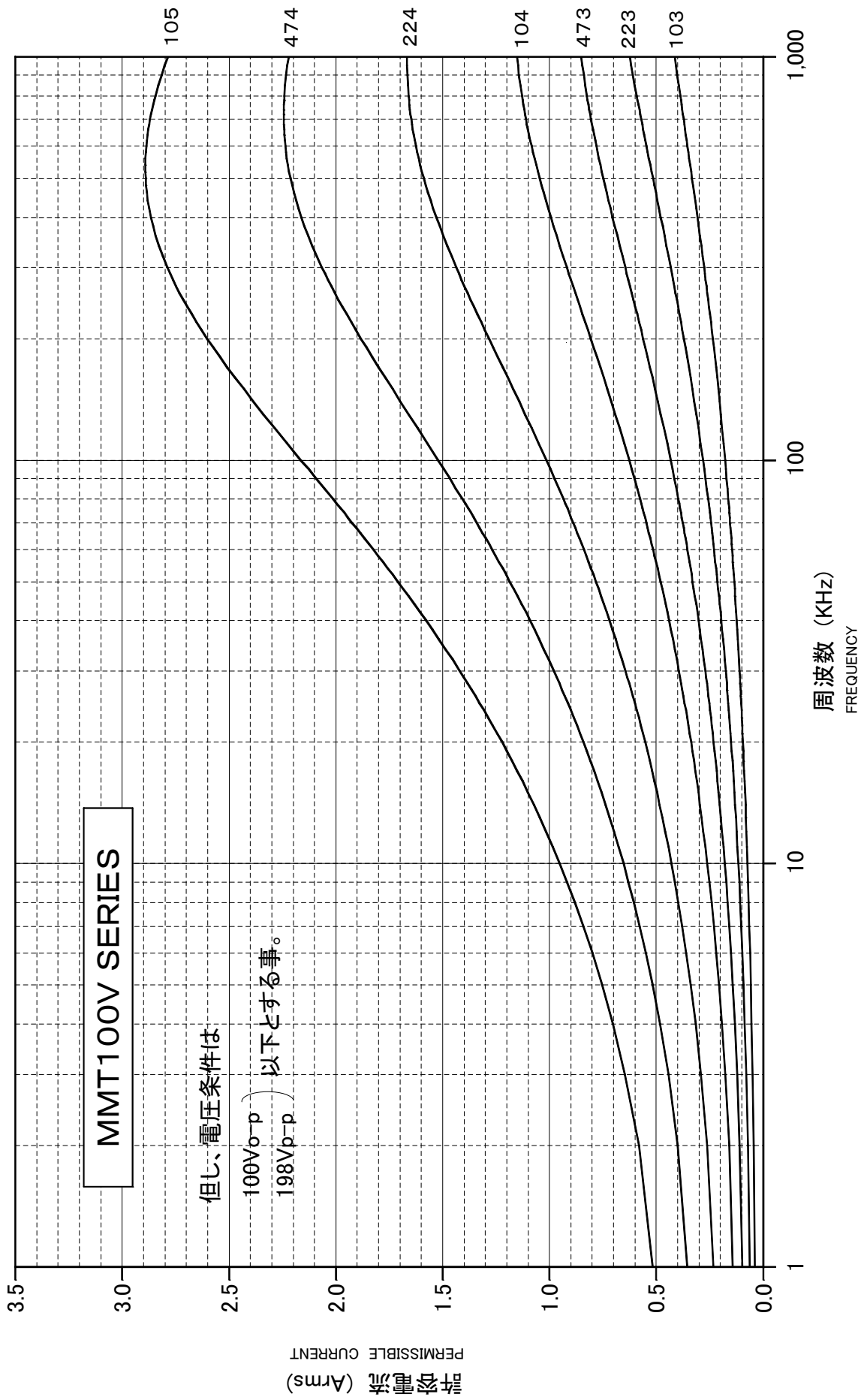

周波数に対する許容電流特性

CHARACTERISTICS OF PERMISSIBLE CURRENT TO FREQUENCY

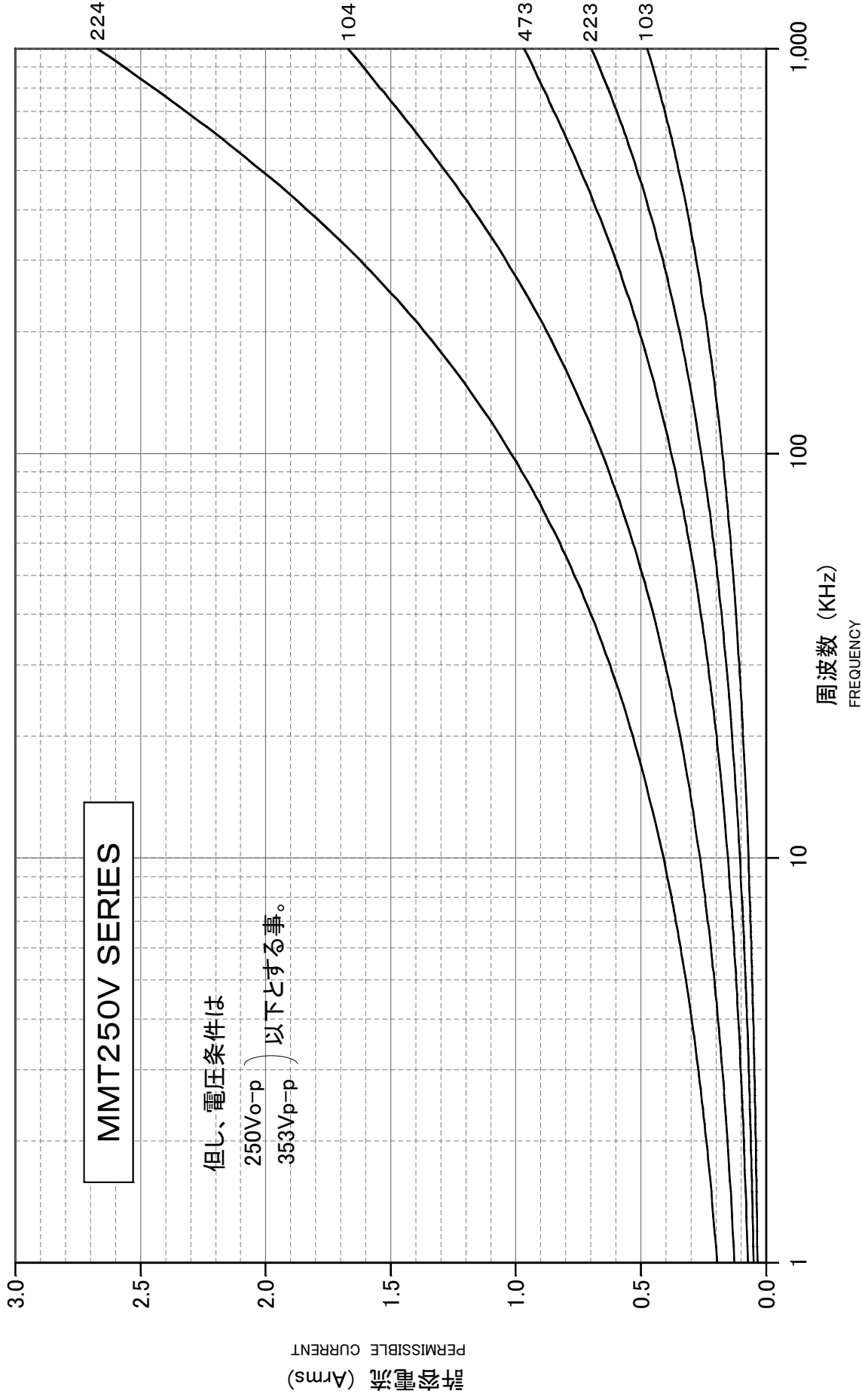

許容ピーク電流値 (パルス電流) Permissible Peak Current (Pulse Current)

◆Type MMT

容量記号 Capacitance Symbol	静電容量 Capacitance (μ F)	50V. dc		63V. dc		100V. dc		250V. dc	
		単発 Single (Ao-p)	連続 Continual (Ao-p)	単発 Single (Ao-p)	連続 Continual (Ao-p)	単発 Single (Ao-p)	連続 Continual (Ao-p)	単発 Single (Ao-p)	連続 Continual (Ao-p)
103	0.010	0.36	0.14	0.42	0.14	0.69	0.37	1.21	0.53
123	0.012	0.43	0.17	0.50	0.17	0.83	0.45	1.45	0.64
153	0.015	0.54	0.21	0.62	0.21	1.04	0.45	1.81	0.79
183	0.018	0.65	0.25	0.75	0.25	1.24	0.54	2.17	0.67
223	0.022	0.79	0.31	0.91	0.31	1.52	0.66	2.66	0.82
273	0.027	0.97	0.38	1.12	0.38	1.86	0.82	3.26	1.00
333	0.033	1.19	0.46	1.37	0.46	2.28	1.00	3.98	1.22
393	0.039	1.40	0.55	1.62	0.55	2.69	0.62	4.71	1.45
473	0.047	1.69	0.66	1.95	0.66	3.24	0.75	5.67	1.74
563	0.056	2.02	0.78	2.32	0.78	3.86	0.89	6.76	2.08
683	0.068	2.45	0.95	2.82	0.95	4.69	0.97	8.21	2.52
823	0.082	2.95	1.15	3.40	1.15	5.66	1.17	9.90	3.04
104	0.10	3.60	1.40	4.15	1.40	6.90	1.43	12.07	3.71
124	0.12	4.32	1.68	4.98	1.68	8.28	1.72	14.48	4.45
154	0.15	5.40	2.10	6.23	2.10	10.35	2.14	18.11	5.56
184	0.18	6.48	2.52	7.47	2.52	12.42	2.57	13.50	3.34
224	0.22	7.92	3.08	9.13	3.08	15.18	3.15	16.50	4.08
274	0.27	9.72	3.78	11.21	3.78	18.63	3.86		
334	0.33	11.88	4.62	13.70	4.62	22.77	4.72		
394	0.39	14.04	5.46	16.19	5.46	26.91	5.58		
474	0.47	16.92	6.58	19.51	6.58	32.43	6.72		
564	0.56	20.16	7.84	23.24	7.84	38.64	8.01		
684	0.68	24.48	9.52	28.22	9.52	46.92	9.72		
824	0.82	29.52	11.48	34.03	11.48	56.58	11.72		
105	1.0	36.00	14.00	41.50	14.00	69.00	14.30		
125	1.2	24.00	9.60	27.60	9.60				
155	1.5	30.00	12.00	34.50	12.00				
185	1.8	36.00	14.40	41.40	14.40				
225	2.2	44.00	17.60	50.60	17.60				
275	2.7	54.00	21.60	62.12	21.60				
335	3.3	66.00	26.40	75.90	26.40				

SPECIFICATION

STACKED TYPE -
METALLIZED POLYESTER FILM CAPACITOR

SPEC No.

P S C 4 0 1 0 0 0

Drawing of dimension

• MMT : Straight lead type

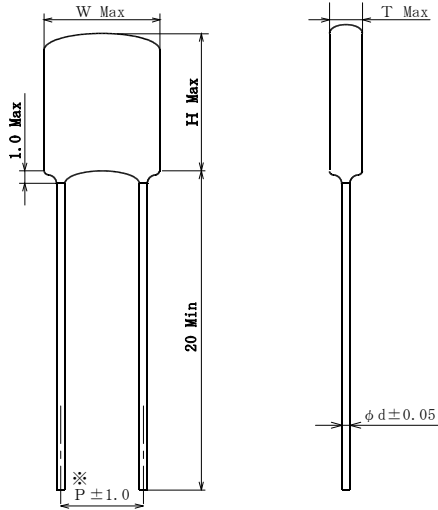

• MMT C : Cutted lead type

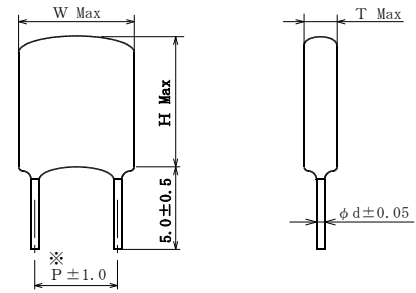

※ 63V : $P \pm 1.5mm$

• MMT F : Single-formed lead type

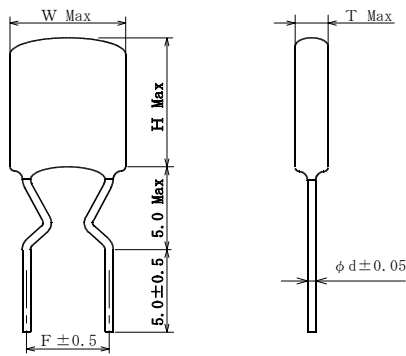

• MMT D : Double-formed lead type

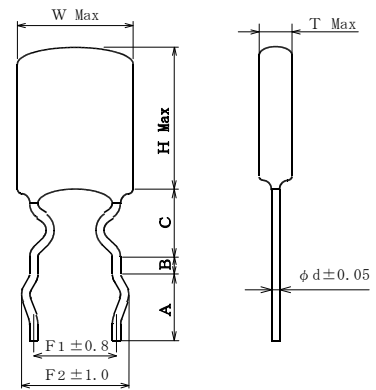

A	$3.5 \pm 0.5mm$
B	$1.2mm_{Max}$
C	$3.5 \pm 0.5mm$

SPECIFICATION

STACKED TYPE -
METALLIZED POLYESTER FILM CAPACITOR

SPEC No.

P S C 4 0 1 0 0 0

MMT, MMTF, MMTD, MMTC-50V. DC

Parts No.	Capacitance (μ F)	Dimensions (mm)							
		W	H	T	P	F	F ₁	F ₂	ϕ d
MMT□□0050J1030000□□□□	0.010	7.3	5.0	3.2	5.0	5.0	5.0	6.5	0.5
MMT□□0050J1230000□□□□	0.012	□	□	□	□	□	□	□	□
MMT□□0050J1530000□□□□	0.015	□	□	□	□	□	□	□	□
MMT□□0050J1830000□□□□	0.018	□	□	□	□	□	□	□	□
MMT□□0050J2230000□□□□	0.022	□	□	□	□	□	□	□	□
MMT□□0050J2730000□□□□	0.027	□	□	□	□	□	□	□	□
MMT□□0050J3330000□□□□	0.033	□	□	□	□	□	□	□	□
MMT□□0050J3930000□□□□	0.039	□	□	□	□	□	□	□	□
MMT□□0050J4730000□□□□	0.047	□	□	□	□	□	□	□	□
MMT□□0050J5630000□□□□	0.056	□	□	□	□	□	□	□	□
MMT□□0050J6830000□□□□	0.068	□	□	□	□	□	□	□	□
MMT□□0050J8230000□□□□	0.082	□	□	□	□	□	□	□	□
MMT□□0050J1040000□□□□	0.10	□	□	□	□	□	□	□	□
MMT□□0050J1240000□□□□	0.12	□	□	□	□	□	□	□	□
MMT□□0050J1540000□□□□	0.15	□	5.5	3.5	□	□	□	□	□
MMT□□0050J1840000□□□□	0.18	□	□	4.0	□	□	□	□	□
MMT□□0050J2240000□□□□	0.22	□	□	4.3	□	□	□	□	□
MMT□□0050J2740000□□□□	0.27	□	6.5	□	□	□	□	□	□
MMT□□0050J3340000□□□□	0.33	□	□	4.8	□	□	□	□	□
MMT□□0050J3940000□□□□	0.39	□	7.0	5.0	□	□	□	□	□
MMT□□0050J4740000□□□□	0.47	□	8.0	5.5	□	□	□	□	□
MMT□□0050J5640000□□□□	0.56	□	□	5.8	□	□	□	□	□
MMT□□0050J6840000□□□□	0.68	□	8.5	6.5	□	□	□	□	□
MMT□□0050J8240000□□□□	0.82	□	9.5	□	□	□	□	□	□
MMT□□0050J1050000□□□□	1.0	□	□	7.5	□	□	□	□	□
MMT□□0050J1250000□□□□	1.2	10.0	□	5.5	7.5	□	□	□	□
MMT□□0050J1550000□□□□	1.5	□	□	6.5	□	□	□	□	□
MMT□□0050J1850000□□□□	1.8	□	11.0	□	□	□	□	□	□
MMT□□0050J2250000□□□□	2.2	□	□	7.0	□	□	□	□	□
MMT□□0050J2750000□□□□	2.7	□	13.5	□	□	□	□	□	□
MMT□□0050J3350000□□□□	3.3	□	□	8.0	□	□	□	□	□

SPECIFICATION

STACKED TYPE -
METALLIZED POLYESTER FILM CAPACITOR

SPEC No.

P S C 4 0 1 0 0 0

MMT, MMTF, MMTD, MMTC-63V. DC

Parts No.	Capacitance (μ F)	Dimensions (mm)							
		W	H	T	P	F	F ₁	F ₂	ϕ d
MMT□□0063J1030000□□□□	0.010	8.0	5.0	3.2	5.0	5.0	5.0	6.5	0.5
MMT□□0063J1230000□□□□	0.012	〃	〃	〃	〃	〃	〃	〃	〃
MMT□□0063J1530000□□□□	0.015	〃	〃	〃	〃	〃	〃	〃	〃
MMT□□0063J1830000□□□□	0.018	〃	〃	〃	〃	〃	〃	〃	〃
MMT□□0063J2230000□□□□	0.022	〃	〃	〃	〃	〃	〃	〃	〃
MMT□□0063J2730000□□□□	0.027	〃	〃	〃	〃	〃	〃	〃	〃
MMT□□0063J3330000□□□□	0.033	〃	〃	〃	〃	〃	〃	〃	〃
MMT□□0063J3930000□□□□	0.039	〃	〃	〃	〃	〃	〃	〃	〃
MMT□□0063J4730000□□□□	0.047	〃	〃	〃	〃	〃	〃	〃	〃
MMT□□0063J5630000□□□□	0.056	〃	〃	〃	〃	〃	〃	〃	〃
MMT□□0063J6830000□□□□	0.068	〃	〃	〃	〃	〃	〃	〃	〃
MMT□□0063J8230000□□□□	0.082	〃	〃	〃	〃	〃	〃	〃	〃
MMT□□0063J1040000□□□□	0.10	〃	〃	〃	〃	〃	〃	〃	〃
MMT□□0063J1240000□□□□	0.12	〃	〃	〃	〃	〃	〃	〃	〃
MMT□□0063J1540000□□□□	0.15	〃	5.5	3.5	〃	〃	〃	〃	〃
MMT□□0063J1840000□□□□	0.18	〃	〃	〃	〃	〃	〃	〃	〃
MMT□□0063J2240000□□□□	0.22	〃	〃	3.8	〃	〃	〃	〃	〃
MMT□□0063J2740000□□□□	0.27	〃	6.5	4.3	〃	〃	〃	〃	〃
MMT□□0063J3340000□□□□	0.33	〃	〃	4.5	〃	〃	〃	〃	〃
MMT□□0063J3940000□□□□	0.39	〃	7.0	5.0	〃	〃	〃	〃	〃
MMT□□0063J4740000□□□□	0.47	〃	8.0	〃	〃	〃	〃	〃	〃
MMT□□0063J5640000□□□□	0.56	〃	10.0	4.3	〃	〃	〃	〃	〃
MMT□□0063J6840000□□□□	0.68	〃	〃	4.5	〃	〃	〃	〃	〃
MMT□□0063J8240000□□□□	0.82	〃	〃	5.0	〃	〃	〃	〃	〃
MMT□□0063J1050000□□□□	1.0	〃	〃	5.3	〃	〃	〃	〃	〃
MMT□□0063J1250000□□□□	1.2	11.0	10.0	4.7	7.5	〃	〃	〃	〃
MMT□□0063J1550000□□□□	1.5	〃	11.0	5.0	〃	〃	〃	〃	〃
MMT□□0063J1850000□□□□	1.8	〃	〃	5.5	〃	〃	〃	〃	〃
MMT□□0063J2250000□□□□	2.2	〃	12.0	6.0	〃	〃	〃	〃	〃
MMT□□0063J2750000□□□□	2.7	〃	13.5	6.5	〃	〃	〃	〃	〃
MMT□□0063J3350000□□□□	3.3	〃	〃	7.0	〃	〃	〃	〃	〃

SPECIFICATION

STACKED TYPE -
METALLIZED POLYESTER FILM CAPACITOR

SPEC No.

P S C 4 0 1 0 0 0

MMT, MMTF, MMTD, MMTC-100V. DC

Parts No.	Capacitance (μ F)	Dimensions (mm)							
		W	H	T	P	F	F ₁	F ₂	ϕ d
MMT□□□100J1030000□□□□	0.010	7.3	5.0	3.2	5.0	5.0	5.0	6.5	0.5
MMT□□□100J1230000□□□□	0.012	〃	〃	〃	〃	〃	〃	〃	〃
MMT□□□100J1530000□□□□	0.015	〃	〃	〃	〃	〃	〃	〃	〃
MMT□□□100J1830000□□□□	0.018	〃	〃	〃	〃	〃	〃	〃	〃
MMT□□□100J2230000□□□□	0.022	〃	〃	〃	〃	〃	〃	〃	〃
MMT□□□100J2730000□□□□	0.027	〃	〃	〃	〃	〃	〃	〃	〃
MMT□□□100J3330000□□□□	0.033	〃	〃	〃	〃	〃	〃	〃	〃
MMT□□□100J3930000□□□□	0.039	〃	〃	〃	〃	〃	〃	〃	〃
MMT□□□100J4730000□□□□	0.047	〃	〃	〃	〃	〃	〃	〃	〃
MMT□□□100J5630000□□□□	0.056	〃	〃	〃	〃	〃	〃	〃	〃
MMT□□□100J6830000□□□□	0.068	〃	〃	〃	〃	〃	〃	〃	〃
MMT□□□100J8230000□□□□	0.082	〃	〃	〃	〃	〃	〃	〃	〃
MMT□□□100J1040000□□□□	0.10	〃	〃	〃	〃	〃	〃	〃	〃
MMT□□□100J1240000□□□□	0.12	〃	5.5	〃	〃	〃	〃	〃	〃
MMT□□□100J1540000□□□□	0.15	〃	5.0	4.0	〃	〃	〃	〃	〃
MMT□□□100J1840000□□□□	0.18	〃	〃	4.3	〃	〃	〃	〃	〃
MMT□□□100J2240000□□□□	0.22	〃	〃	4.7	〃	〃	〃	〃	〃
MMT□□□100J2740000□□□□	0.27	〃	6.0	〃	〃	〃	〃	〃	〃
MMT□□□100J3340000□□□□	0.33	〃	〃	5.3	〃	〃	〃	〃	〃
MMT□□□100J3940000□□□□	0.39	〃	6.5	〃	〃	〃	〃	〃	〃
MMT□□□100J4740000□□□□	0.47	〃	7.5	〃	〃	〃	〃	〃	〃
MMT□□□100J5640000□□□□	0.56	〃	〃	5.6	〃	〃	〃	〃	〃
MMT□□□100J6840000□□□□	0.68	〃	8.5	〃	〃	〃	〃	〃	〃
MMT□□□100J8240000□□□□	0.82	〃	〃	6.5	〃	〃	〃	〃	〃
MMT□□□100J1050000□□□□	1.0	〃	10.0	〃	〃	〃	〃	〃	〃

SPECIFICATION

STACKED TYPE -
METALLIZED POLYESTER FILM CAPACITOR

SPEC No.

P S C 4 0 1 0 0 0

MMT, MMTF, MMTD, MMTC-250V. DC

Parts No.	Capacitance (μ F)	Dimensions (mm)							
		W	H	T	P	F	F ₁	F ₂	ϕ d
MMT□□0250J1030000□□□□	0.010	7.3	5.0	3.2	5.0	5.0	5.0	6.5	0.5
MMT□□0250J1230000□□□□	0.012	"	5.5	"	"	"	"	"	"
MMT□□0250J1530000□□□□	0.015	"	5.0	"	"	"	"	"	"
MMT□□0250J1830000□□□□	0.018	"	5.5	"	"	"	"	"	"
MMT□□0250J2230000□□□□	0.022	"	"	"	"	"	"	"	"
MMT□□0250J2730000□□□□	0.027	"	"	"	"	"	"	"	"
MMT□□0250J3330000□□□□	0.033	"	6.0	"	"	"	"	"	"
MMT□□0250J3930000□□□□	0.039	"	"	3.5	"	"	"	"	"
MMT□□0250J4730000□□□□	0.047	"	6.4	"	"	"	"	"	"
MMT□□0250J5630000□□□□	0.056	"	"	3.8	"	"	"	"	"
MMT□□0250J6830000□□□□	0.068	"	6.8	"	"	"	"	"	"
MMT□□0250J8230000□□□□	0.082	"	7.4	4.2	"	"	"	"	"
MMT□□0250J1040000□□□□	0.10	"	8.2	"	"	"	"	"	"
MMT□□0250J1240000□□□□	0.12	"	"	4.7	"	"	"	"	"
MMT□□0250J1540000□□□□	0.15	"	10.0	"	"	"	"	"	"
MMT□□0250J1840000□□□□	0.18	"	9.5	6.2	"	"	"	"	"
MMT□□0250J2240000□□□□	0.22	"	10.5	"	"	"	"	"	"

SPECIFICATION

STACKED TYPE -
METALLIZED POLYESTER FILM CAPACITOR

SPEC No.

P S C 4 0 1 0 0 0

SPECIFICATION OF TAPING FOR AUTOMATIC INSERTION (Type MMTV, MMTS)

1. SCOPE

This specification applies to the taping dimensions and performance required for film capacitors used in the automatic radial insertion system.

Style of packing : Ammo pack

2. TAPING DIMENSIONS

Type	Taping style	STYLE-1
	Rated voltage	
MMTV	50V. DC	103~155
	63V. DC	103~155
	100V. DC	103~105
	250V. DC	103~224

Type	Taping style	STYLE-1
	Rated voltage	
MMTS	50V. DC	103~105
	63V. DC	103~105
	100V. DC	103~105
	250V. DC	103~224

3. TAPING PERFORMANCE (to be satisfied with the following point)

3-1. Appearance : To be no damages or cracks on components and the tape.

3-2. Missing components : A maximum of 3 consecutive components may be missing.

3-3. Tip of the tape : To leave the blank tape more than 4.5 feed hole pitch from the start, and the end of the tape.

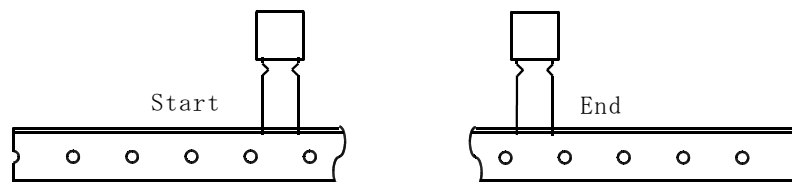

3-4. Tape splicing : Tape splicing may be done with (1) or (2).

(1) The carrier tape (include hold-down tape) shall be cut at the center of hole and hole, and spliced with tape.

(2) The carrier tape (include hold down tape) shall be cut at the center of hole, and spliced with splicing tape.

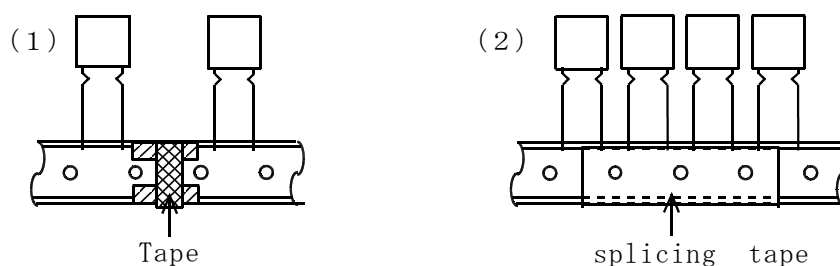

SPECIFICATION	STACKED TYPE - METALLIZED POLYESTER FILM CAPACITOR	SPEC No. P S C 4 0 1 0 0 0
---------------	---	-----------------------------------

3-5. Adhesive strength : When pulling an adhesive tape in W direction (upward) using a push-and-pull scale, adhesive strength shall be 3N or more

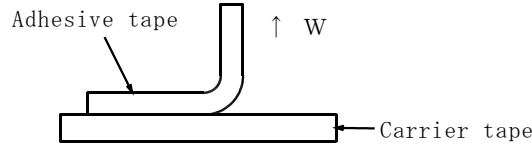

3-6. Tensile test : When pulling a test sample by the force 10N, there shall be no gaps or breakdowns.

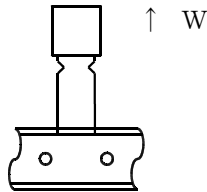

3-7. Moisture resistance : A taped test sample shall be left in a chamber with a temperature of 40°C and 95%RH for 96 hours. Then after being left for one hour at room temperature the test sample shall be submitted to a tensile test of item 3-6.

3-8. Temperature cycling test : A test sample shall be submitted to 5 cycles of temperature cycling test.
 One cycle consists of : 2 hours at -40°C
 2 hours at +85°C
 Then after being left for one hour at room temperature, the test sample shall be submitted to a tensile test of item 3-6.

4. BOX DIMENSIONS

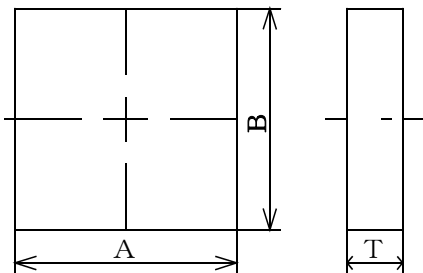

(Unit : mm)

A	B	T
330±7	355±7	45±5

SPECIFICATION

STACKED TYPE -
METALLIZED POLYESTER FILM CAPACITOR

SPEC No.

P S C 4 0 1 0 0 0

5. STYLE OF PACKING (Ammo pack)

5-1. Packaging

- * Fold the tape in the cardboard box, with hold-down tepe turning up against an outlet opening.
- * Thread the feed hole with a axle and fix the tape.

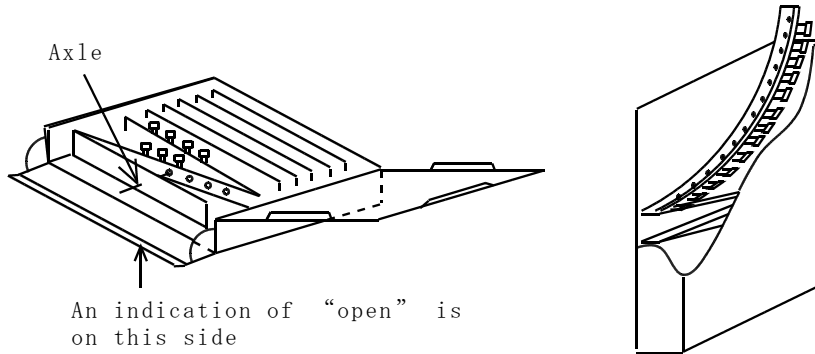

5-2. Marking

The following particulars shall be labelled on the surface of a box.

Example)

CODE CUSTOMER				INSP DATE		PKG NO	
①				②			
PARTS NO				MACH NO		QTY/PKG	
③				④			
ORDER NO			LOT NO			ROHS	
⑤			⑥			⑦	
TYPE	WV	TOL	CAP	EDP CODE		QT (PCS)	
⑧	⑨	⑩	⑪	⑫		⑬	

- ①CODE CUSTOMER ④MACH NO ⑦PRODUCTION COUNTRY ⑩TOL (%)
- ②INSP DATE ⑤ORDER NO ⑧TYPE ⑪CAP
- ③PARTS NO ⑥LOT NO ⑨W V ⑫EDP CODE
- ⑬QT (PCS)

SPECIFICATION	STACKED TYPE - METALLIZED POLYESTER FILM CAPACITOR	SPEC No. P S C 4 0 1 0 0 0
---------------	---	-----------------------------------

Type MMTV	103 ~ 155	50V. DC
STYLE - 1	103 ~ 155	63V. DC
(0200)	103 ~ 105	100V. DC
	103 ~ 224	250V. DC

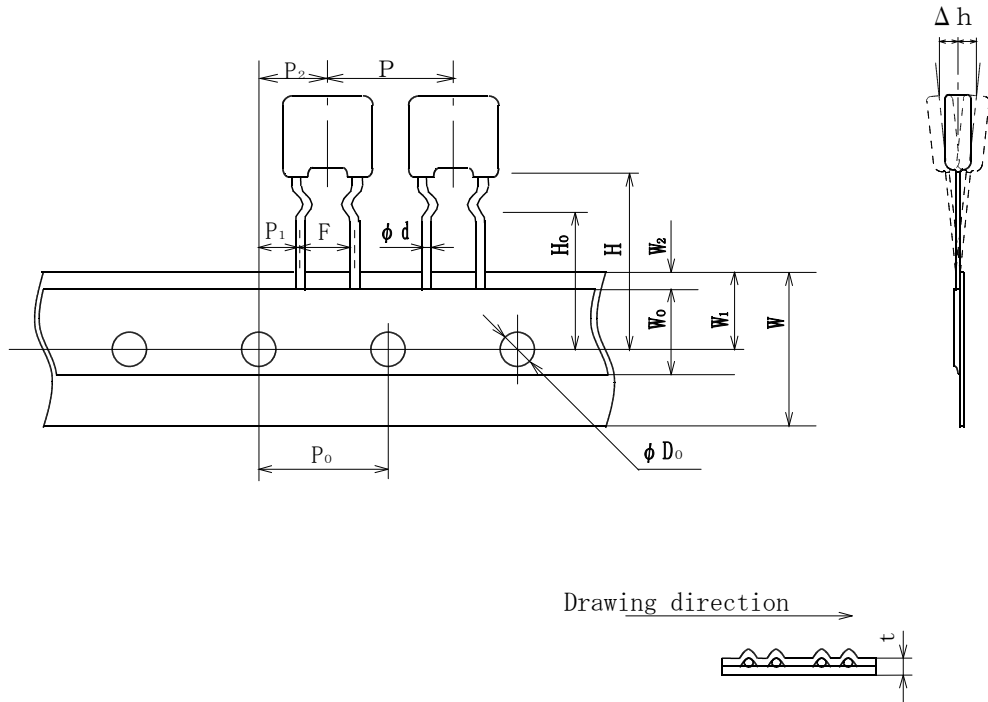

(Unit : mm)

P	P ₀	(1) P ₁	P ₂	φ d	(1) F	(2) Δ h	W	W ₀	W ₁	(3) W ₂	H	(1) H ₀	φ D ₀	t
12.7	12.7	3.85	6.35	0.5	5.0	0	18.0	≥5.0	9.0	3.0 Max	21.5 Max	16.0	4.0	0.7
±1.0	±0.3	±0.7	±1.3	±0.05	±0.8 ±0.2	±2.0	±1.0 ±0.5	—	±0.5	—	—	±0.5	±0.2	±0.2

- (1) To be measured under the clinch-position.
- (2) To be measured the top of component.
- (3) Hold-down tape is not to exceed over the carrier tape.

SPECIFICATION	STACKED TYPE - METALLIZED POLYESTER FILM CAPACITOR	SPEC No. P S C 4 0 1 0 0 0
---------------	---	-----------------------------------

Type MMT S	103 ~ 105	50V. DC
STYLE - 1	103 ~ 105	63V. DC
(0200)	103 ~ 105	100V. DC
	103 ~ 224	250V. DC

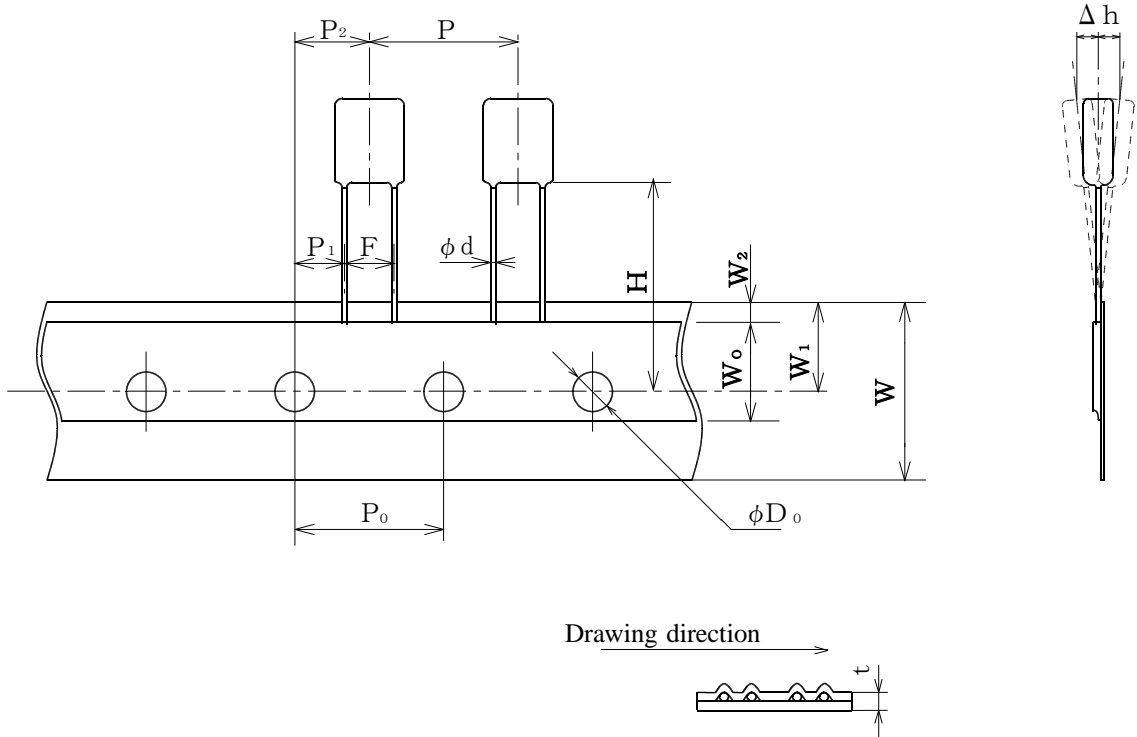

(Unit : mm)

P	P ₀	P ₁	P ₂	φ d	F	(1) Δ h	W	W ₀	W ₁	(2) W ₂	H	φ D ₀	t
12.7	12.7	3.85	6.35	0.5	5.0	0	18.0	≥5.0	9.0	3.0 Max	18.5	4.0	0.7
±1.0	±0.3	±0.7	±1.3	±0.05	+0.8 -0.2	±2.0	+0.1 -0.5	—	±0.5	—	±0.5	±0.2	±0.2

(1) To be measured the top of component.

(2) Hold-down tape is not to exceed over the carrier tape.

SPECIFICATION

 STACKED TYPE -
 METALLIZED POLYESTER FILM CAPACITOR

SPEC No.

P S C 4 0 1 0 0 0

Packing quantity

MMTV, MMTS-50V. DC

(Unit : pcs)

Capacitance (μ F)	STYLE-1 (0200)	Capacitance (μ F)	STYLE-1 (0200)
0.010	2,000	0.27	1,000
0.012	"	0.33	"
0.015	"	0.39	"
0.018	"	0.47	"
0.022	"	0.56	"
0.027	"	0.68	"
0.033	"	0.82	"
0.039	"	1.0	"
0.047	"	1.2	"
0.056	"	1.5	"
0.068	"		
0.082	"		
0.10	"		
0.12	"		
0.15	"		
0.18	"		
0.22	"		

SPECIFICATION

 STACKED TYPE -
 METALLIZED POLYESTER FILM CAPACITOR

SPEC No.

P S C 4 0 1 0 0 0

Packing quantity

MMTV, MMTS-63V. DC

(Unit : pcs)

Capacitance (μ F)	STYLE-1 (0200)	Capacitance (μ F)	STYLE-1 (0200)
0.010	2,000	0.27	1,000
0.012	"	0.33	"
0.015	"	0.39	"
0.018	"	0.47	"
0.022	"	0.56	"
0.027	"	0.68	"
0.033	"	0.82	"
0.039	"	1.0	"
0.047	"	1.2	"
0.056	"	1.5	"
0.068	"		
0.082	"		
0.10	"		
0.12	"		
0.15	"		
0.18	"		
0.22	"		

SPECIFICATION

 STACKED TYPE -
 METALLIZED POLYESTER FILM CAPACITOR

SPEC No.

P S C 4 0 1 0 0 0

Packing quantity

MMTV, MMTS-100V. DC

(Unit : pcs)

Capacitance (μ F)	STYLE-1 (0200)	Capacitance (μ F)	STYLE-1 (0200)
0.010	2,000	0.22	1,000
0.012	"	0.27	"
0.015	"	0.33	"
0.018	"	0.39	"
0.022	"	0.47	"
0.027	"	0.56	"
0.033	"	0.68	"
0.039	"	0.82	"
0.047	"	1.0	"
0.056	"		
0.068	"		
0.082	"		
0.10	"		
0.12	"		
0.15	"		
0.18	"		

SPECIFICATION	STACKED TYPE - METALLIZED POLYESTER FILM CAPACITOR	SPEC No. P S C 4 0 1 0 0 0
---------------	---	-----------------------------------

Packing quantity

MMTV, MMTS-250V. DC (Unit : pcs)

Capacitance (μ F)	STYLE-1 (0200)	Capacitance (μ F)	STYLE-1 (0200)
0.010	2,000	0.12	1,000
0.012	"	0.15	"
0.015	"	0.18	"
0.018	"	0.22	"
0.022	"	X	
0.027	"		
0.033	"		
0.039	"		
0.047	"		
0.056	"		
0.068	"		
0.082	"		
0.10	"		



Cautions about safety In use of Capacitors

(MMT type)

Registry No.

HWC 4 0 1 0 0 0

Rev. No.

0 2

Sheet No.

1 / 2

When using a capacitor, please use one within the range of the specified values in the specification after checking the environments of using and mounting.

If used beyond the range specified in the specification or the attached cautions, it may lead to short circuit, open, smoking and firing.

Be sure to inquire of us as to the items which are not specified in the specification or are unclear to you.

Also, in case of using capacitors for such equipment or apparatus as may possibly affect human lives like life-support systems, aircraft and automotive control system, etc., please never fail to inquire of us as to further details.

1. Operating temperature and humidity

- (1) In actual use, make sure that the operating temperature is within the range specified in the specification.
- (2) Even if the operating temperature is within the specified range, sudden change in the operating temperature may lead to cracks on the enclosure and result in deterioration of the insulation resistance or the increase in tangent of loss angle by absorbing moisture through cracks on the enclosure. Please take good care of the operating temperature.
- (3) Please avoid using a capacitor in high humidity which may lead to the condensation as much as possible.

Even if there are no cracks or damage on an enclosure, deterioration of the insulation resistance or the increase in tangent of loss angle, etc. may be caused by absorbing moisture. Therefore, please be careful when using a capacitor.

2. When using a capacitor in a circuit except a d.c. one

When using a capacitor in a circuit except a d.c. one, a capacitor shall be used below the permissible current to frequency.

When used beyond the specified values, the capacitor surface temperature may rise due to the occurrence of corona charge or self heat generation of a capacitor and it may result in a short life, the destruction of the dielectric or the lowering of the insulation resistance.

At worst smoking or firing may be led.

3. Soldering

When soldering a capacitor, heat in soldering is conducted to the inside of the capacitor through lead wires and an enclosure.

Therefore soldering at high temperature and for hours may cause deterioration of characteristics or breakdown of a capacitor.

Be sure to solder a capacitor within the range specified in the specification when soldering.

In case of soldering beyond the range recommended by us, please inquire of us as to the details in advance.

- (1) Avoid soldering over again in a short time.

When dipping again in order to correct, dipping must be applied after the temperature of a capacitor comes down to a room temperature and within twice.

- (2) Avoid any work that puts the stress on lead wires of a capacitor such as correction of the position right after soldering.
- (3) When soldering with a soldering iron, please see to it lest a soldering iron should touch the body of a capacitor directly.

	Cautions about safety In use of Capacitors	Registry No. HWC 4 0 1 0 0 0	
	(MMT type)	Rev. No. 0 2	Sheet No. 2 / 2

4. Mounting

- (1) When inserting a lead wire into the printed circuit board, the stress put on a lead wire shall be within the following range.
 - ① Bending of lead wire
When bending a lead wire vertically and then restoring straight, bending of a lead wire in the same place shall be less than two cycles. (One cycle -- bending at 90° and restoring straight)
 - ② Twisting of lead wire
Twisting of a lead wire should be carried out within a turn (a 360° turn) in total.
 - ③ Pulling of lead wire
The load in pulling of a lead wire shall be less than 20N.
In case that the above stress is combined together, the value in application should be set less than half of each value.
- (2) When mounting a capacitor by force owing to the difference of the space between lead wires of a capacitor from the space between the holes on the printed circuit board, be careful.
It may cause breakage of a lead wire or cracks on coating resin.
- (3) When mounting a capacitor of large size or a capacitor on the equipment affected by vibrations, fix the body of a capacitor with resin etc. which has no effect on a capacitor.
However, resin used for fixing shall be a flame retardant and minimum.
- (4) Mount a capacitor lest it should touch other parts.
Especially in case of touching a part with self heat generation, a capacitor may deteriorate due to heat and short circuit may be easily caused owing to lowering of dielectric strength or deterioration of the insulation resistance, etc..

5. Cleaning

- (1) When using the solvents for cleaning, use alcohol derivative cleaning solvents (isopropyl alcohol, etc).
- (2) Since a small amount of ingredient contained in flux may lead to corrosion of terminations of the capacitor or chemical change of the capacitor element, be sure to clean a printed circuit board right after soldering.
- (3) The temperature for drying after cleaning shall be less than the maximum operating temperature.
- (4) When cleaning with solvents but alcohol derivatives, please inquire of us in advance.

6. Storing and waste

- (1) Store under the conditions not exceeding -10 °C ~ +40 °C, 75%RH in the room and avoid storing in the place filled with a sudden change in the temperature, the direct sunlight or corrosive gases (hydrogen sulfide, sulfurous acid, chlorine and ammonia, etc.).
- (2) A long-term storage may cause deterioration of characteristics of a capacitor due to absorbing moisture little by little.
Therefore, be sure to use after checking its characteristics and solderability if stored for over one year.
- (3) As capacitors are classified into industrial waste, please ask experts to dispose of them.

7. The others

Please refer to "Guideline of notabilia for fixed plastic film capacitors for use in electronic equipment" published by Electronic Industries Association of Japan (EIAJ RCR-2350) unless specified in the specification.

X-ON Electronics

Largest Supplier of Electrical and Electronic Components

Click to view similar products for [Film Capacitors](#) category:

Click to view products by [NISSEI](#) manufacturer:

Other Similar products are found below :

[F339X134748MIP2T0](#) [F450KG153J250ALH0J](#) [750-1018](#) [FKP1-1500160010P15](#) [FKP1R031007D00JYSD](#) [FKP1R031507E00JYSD](#)
[FKP1U024707E00KYSD](#) [82DC4100CK60J](#) [82EC1100DQ50K](#) [PFR5101J100J11L16.5TA18](#) [PME261JB5220KR19T0](#) [A451GK223M040A](#)
[A561ED221M450A](#) [QXJ2E474KTPT](#) [QXL2B333KTPT](#) [R49AN347000A1K](#) [EEC2G505HQA406](#) [B25668A6676A375](#) [B25673A4282E140](#)
[BFC233868148](#) [BFC2370GC222](#) [C3B2AD44400B20K](#) [C4ASWBU3220A3EK](#) [CB027C0473J--](#) [CB177I0184J--](#) [CB182K0184J--](#) [23PW210](#)
[950CQW5H-F](#) [SBDC3470AA10J](#) [SCD105K122A3-22](#) [2N3155](#) [A571EH331M450A](#) [FKP1-2202KV5P15](#) [FKS3-680040010P10](#)
[QXL2E473KTPT](#) [445450-1](#) [B25669A3996J375](#) [46KI322000M1M](#) [46KR415050M1K](#) [4BSNBX4100ZBFJ](#) [MKP383510063JKP2T0](#)
[MKPY2-.02230020P15](#) [MKT 1813-368-015](#) [4055292001](#) [46KN410000N1K](#) [EEC2E106HQA405](#) [EEC2G205HQA402](#) [EEC2G805HQA415](#)
[P409CP224M250AH470](#) [82EC2150DQ50K](#)