



High-Quality Sound, J-FET Input, Single Operational Amplifier for Premium Audio

■FEATURES

- High-quality sound
- Operating Voltage $\pm 3.5\text{V}$ to $\pm 18\text{V}$
- Operating Current 5.8mA typ.
- Low Input Bias Current 5pA typ.
- Low Noise 7.5nV/ $\sqrt{\text{Hz}}$ typ. at f=1kHz
- Ultralow Distortion 0.00003% typ. at f=1kHz
- High Slew Rate 35V/ μs typ.
- Gain Bandwidth Product 12MHz typ.
- J-FET Input
- Package Outline DIP8 (OFC lead-frame)
OFC: Oxygen-Free Copper

■GENERAL DESCRIPTION

The MUSES03 is a high-quality sound J-FET input single operational amplifier for premium audio equipment.

The MUSES03 uses advanced circuit design and special material and assembly technology to high-quality sound.

The MUSES03 features high-quality sound, low input bias current, low noise, ultralow distortion and high slew rate, and it is suitable for I/V converters, preamplifiers, active filters, headphone amplifiers, and line amplifiers.

■APPLICATION

- Hi-Fi Audio Application
- Professional Audio Application

■PIN CONFIGURATION

PIN NO.	SYMBOL
1	NC
2	-INPUT
3	+INPUT
4	V-
5	NC
6	OUTPUT
7	V+
8	NC

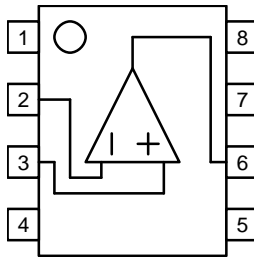

MUSES and this logo are trademarks of New Japan Radio Co., Ltd.

■ORDERING INFORMATION

PART NUMBER	PACKAGE OUTLINE	RoHS	HALOGEN-FREE	TERMINAL FINISH	MARKING	WEIGHT (mg)	MOQ(pcs)
MUSES03	DIP8	yes	yes	Sn-2Bi	03	470	200

Note: "-" is non-evaluation. Please contact your sales representative for more information.

■ABSOLUTE MAXIMUM RATINGS

PARAMETER	SYMBOL	RATINGS	UNIT
Supply Voltage	$V^+ - V^-$	± 19	V
Differential Input Voltage	V_{ID}	± 6	V
Input Voltage	V_{IN}	$\pm 18^{(1)}$	V
Output Peak Current	I_{OP}	250	mA
Power Dissipation ($T_a=25^\circ\text{C}$)	P_D	$870^{(2)}$	mW
Operating Temperature Range	T_{opr}	-40 to +85	$^\circ\text{C}$
Storage Temperature Range	T_{stg}	-50 to +150	$^\circ\text{C}$

(1): If the supply voltage is less than $\pm 18\text{V}$, the input voltage must not over the supply voltage.

(2): Mounted on glass epoxy board. (76.2×114.3×1.6mm: based on EIA/JDEC standard, 2Layers)

■RECOMMENDED OPERATING CONDITIONS

PARAMETER	SYMBOL	RATINGS	UNIT
Supply Voltage	$V^+ - V^-$	± 3.5 to ± 18	V

■POWER DISSIPATION vs. AMBIENT TEMPERATURE

IC is heated by own operation and possibly gets damage when the junction power exceeds the acceptable value called Power Dissipation P_D . The dependence of the MUSES03 P_D on ambient temperature is shown in Fig 1. The plots are depended on following two points. The first is P_D on ambient temperature 25°C, which is the maximum power dissipation. The second is 0W, which means that the IC cannot radiate any more. Conforming the maximum junction temperature T_{jmax} to the storage temperature T_{stg} derives this point. Fig.1 is drawn by connecting those points and conforming the P_D lower than 25°C to it on 25°C. The P_D is shown following formula as a function of the ambient temperature between those points.

$$\text{Dissipation Power } P_D = \frac{T_{jmax} - T_a}{\theta_{ja}} \text{ [W]} \quad (T_a \geq 25^\circ\text{C})$$

Where, θ_{ja} is heat thermal resistance which depends on parameters such as package material, frame material and so on. Therefore, P_D is different in each package.

While, the actual measurement of dissipation power on MUSES03 is obtained using following equation.

$$(\text{Actual Dissipation Power}) = (\text{Supply Current } I_{cc}) \times (\text{Supply Voltage } V^+ - V^-) - (\text{Output Power } P_o)$$

The MUSES03 should be operated in lower than P_D of the actual dissipation power.

To sustain the steady state operation, take account of the Dissipation Power and thermal design.

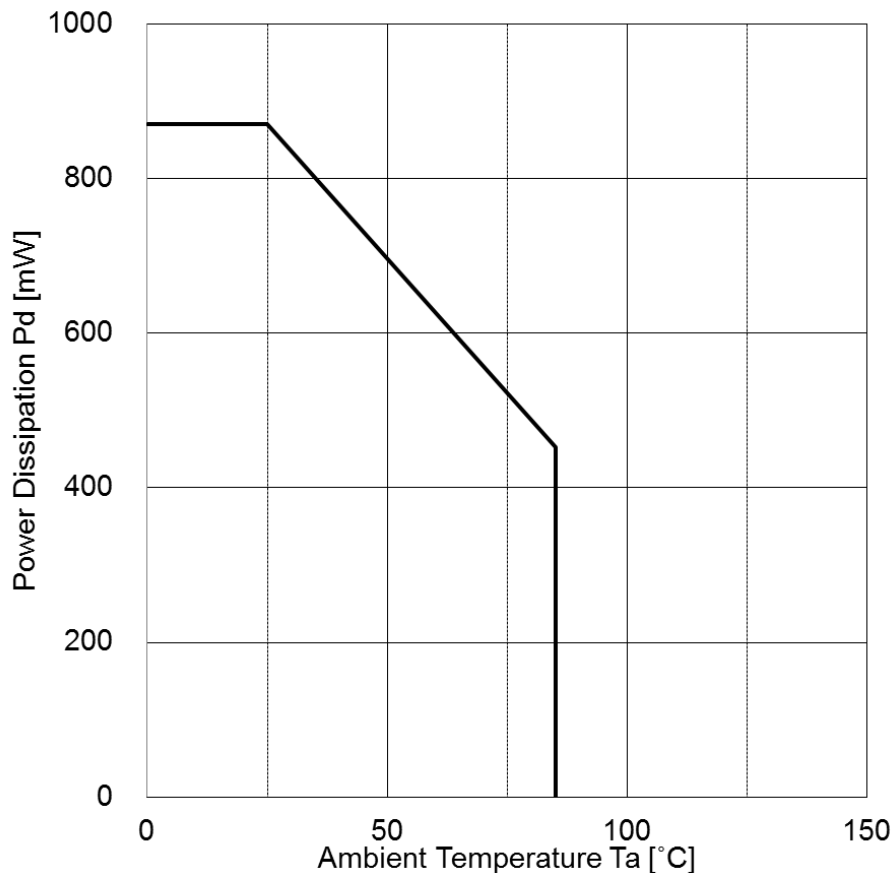

■ ELECTRICAL CHARACTERISTICS (Ta=25 °C)

DC CHARACTERISTICS ($V^+ / V^- = \pm 15V$, R_L to GND, Ta=25°C, unless otherwise specified)

PARAMETER	SYMBOL	TEST CONDITION	MIN.	TYP.	MAX.	UNIT
Operating Current	I _{CC}	No Signal, $R_L = \infty$	-	5.8	10	mA
Input Offset Voltage	V _{IO}	$R_S = 50\Omega$	-	1.0	-	mV
Input Bias Current	I _B		-	5.0	250	pA
Input Offset Current	I _{IO}		-	2.0	220	pA
Voltage Gain 1	A _{V1}	$R_L = 10k\Omega$, $V_o = \pm 13V$	90	115	-	dB
Voltage Gain 2	A _{V2}	$R_L = 2k\Omega$, $V_o = \pm 12.8V$	90	115	-	dB
Voltage Gain 3	A _{V3}	$R_L = 600\Omega$, $V_o = \pm 12.5V$	90	115	-	dB
Common Mode Rejection Ratio	CMR	$V_{ICM} = \pm 12.5V$	70	90	-	dB
Supply Voltage Rejection Ratio	SVR	$V^+ / V^- = \pm 3.5$ to $\pm 18V$	80	100	-	dB
Max Output Voltage 1	V _{OM1}	$R_L = 10k\Omega$	± 13.0	± 14.0	-	V
Max Output Voltage 2	V _{OM2}	$R_L = 2k\Omega$	± 12.8	± 13.8	-	V
Max Output Voltage 3	V _{OM2}	$R_L = 600\Omega$	± 12.5	± 13.5	-	V
Input Common Mode Voltage Range	V _{ICM}	CMR ≥ 70 dB	± 12.0	± 13.0	-	V

AC CHARACTERISTICS ($V^+ / V^- = \pm 15V$, $V_{CM} = 0V$, Ta=25°C, unless otherwise specified)

PARAMETER	SYMBOL	TEST CONDITION	MIN.	TYP.	MAX.	UNIT
Gain Bandwidth Product	GB	f=10kHz	-	12	-	MHz
Unity Gain Frequency	f _T	$A_V = +100$, $R_S = 100\Omega$, $R_L = 2k\Omega$, $C_L = 10pF$	-	13	-	MHz
Phase Margin	Φ_M	$A_V = +100$, $R_S = 100\Omega$, $R_L = 2k\Omega$, $C_L = 10pF$	-	70	-	Deg
Input Noise Voltage1	V _{NI1}	f=1kHz	-	7.5	-	nV/√Hz
Input Noise Voltage2	V _{NI2}	f=20-20kHz	-	1.0	-	μVrms
Total Harmonic Distortion	THD	f=1kHz, $A_V = +10$, $V_o = 5V_{rms}$, $R_L = 2k\Omega$	-	0.00003	-	%
Slew Rate	SR	$A_V = 1$, $V_{IN} = 2V_{p-p}$, $R_L = 2k\Omega$, $C_L = 10pF$	-	35	-	V/us

■ NOTE

The output current should not exceed the maximum output peak current (250mA) of absolute maximum ratings. If the maximum output peak current exceeds 250mA, connect a current-limiting resistor to the output.

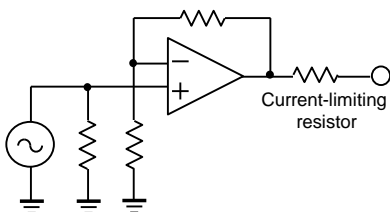

Calculating formula: $R = V / I$

R(Ω): Current-limiting resistor

V(V): Supply voltage

I (A): Output peak current

Example

$18V / 0.2A = 90\Omega$ or more (91Ω, 100Ω)

$9V / 0.2A = 45\Omega$ or more (47Ω, 51Ω)

Resistance value is a reference value. It does not guarantee the characteristics of the product.

■ TYPICAL CHARACTERISTICS

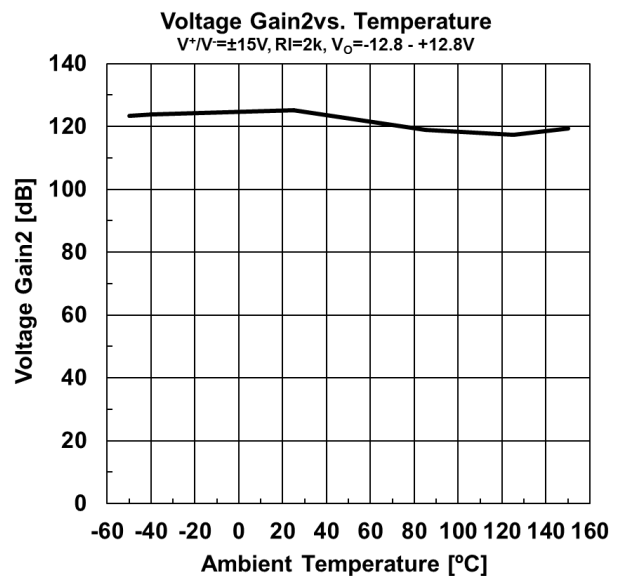
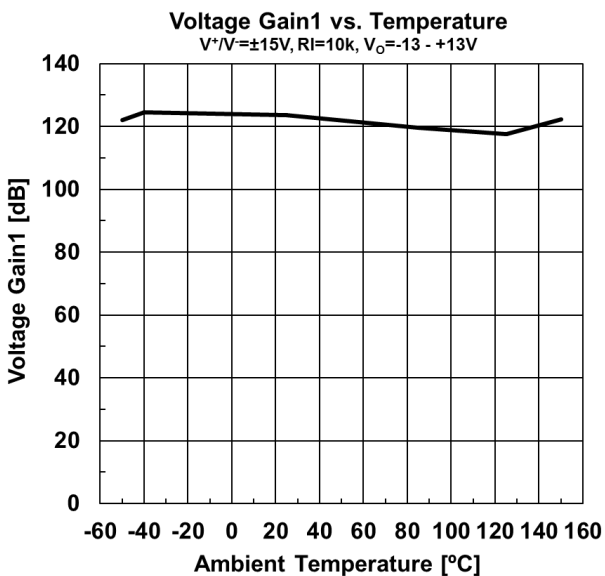
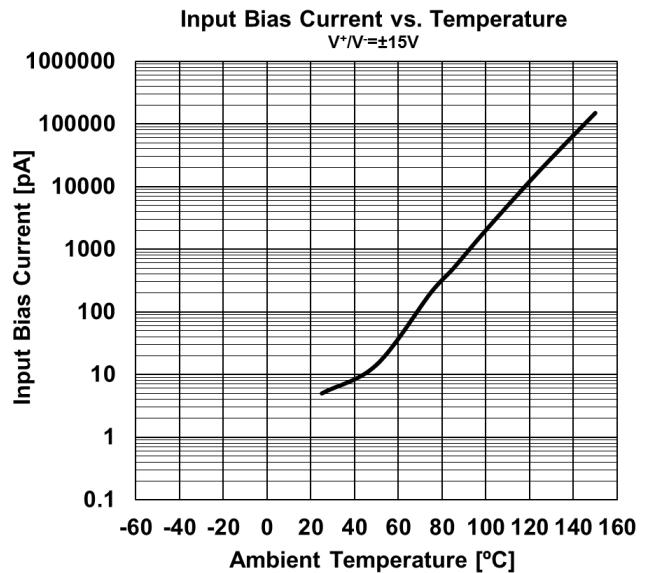
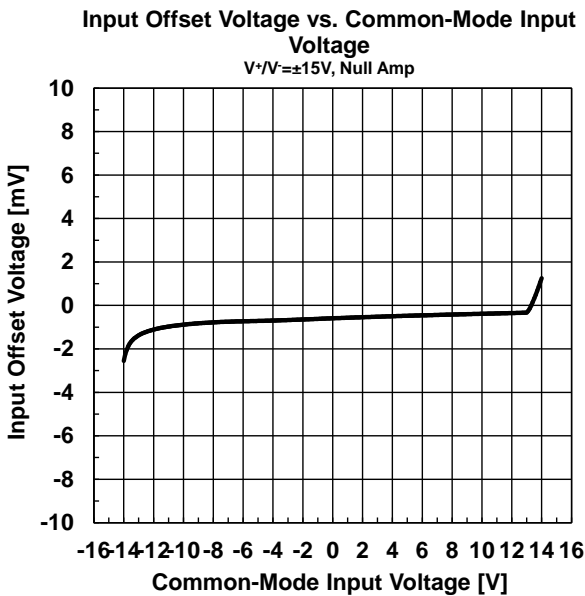
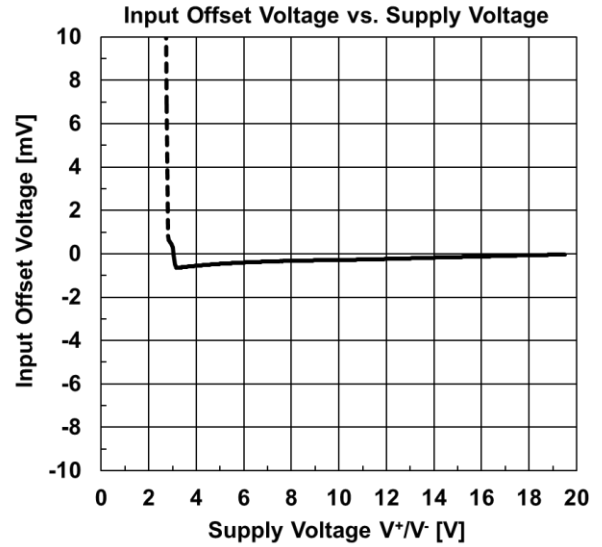
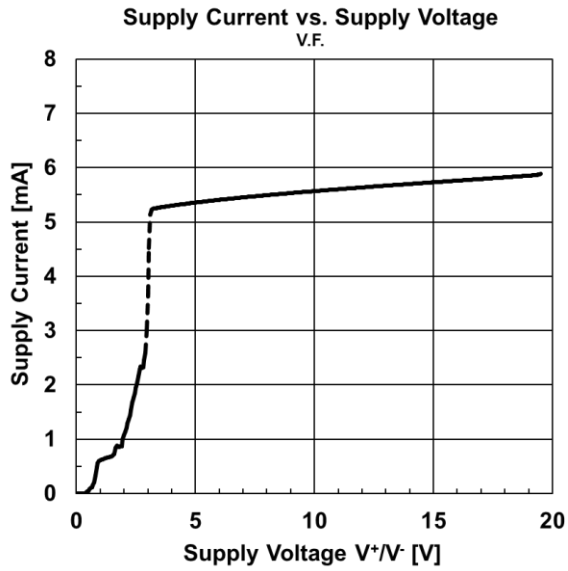

■ TYPICAL CHARACTERISTICS

Voltage Gain3 vs. Temperature
 $V^+/V^-=\pm 15V, R_I=600k, V_O=-12.5 - +12.5V$

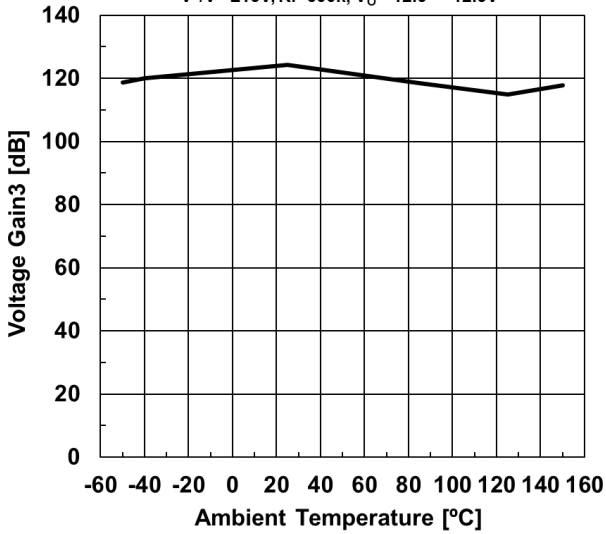

CMR vs. Temperature
 $V^+/V^-=\pm 15V, V_{IN}=-12 \text{ to } 0V,$

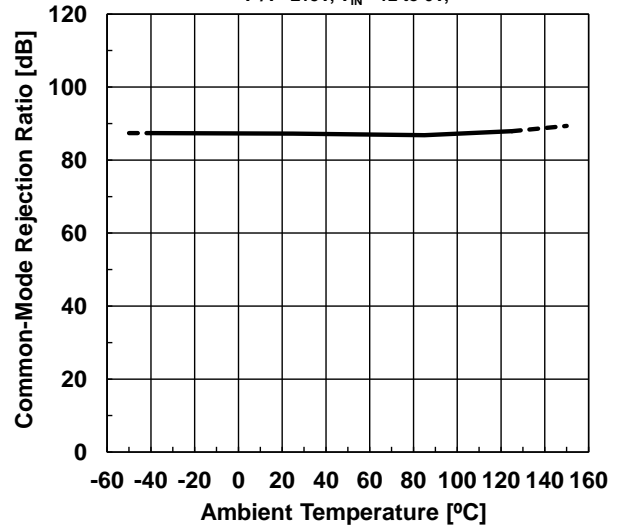

SVR vs. Temperature
 $V^+/V^-=\pm 3.5V - \pm 18V$

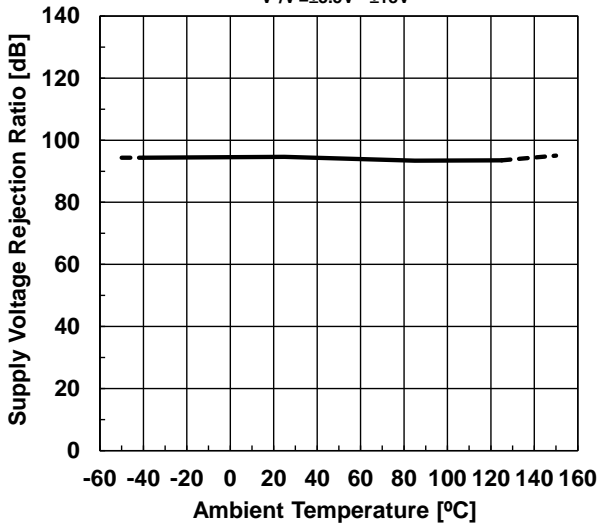

Output Voltage vs. Output Current
 $V^+/V^-=\pm 15V, V_{IN}=\pm 1V$

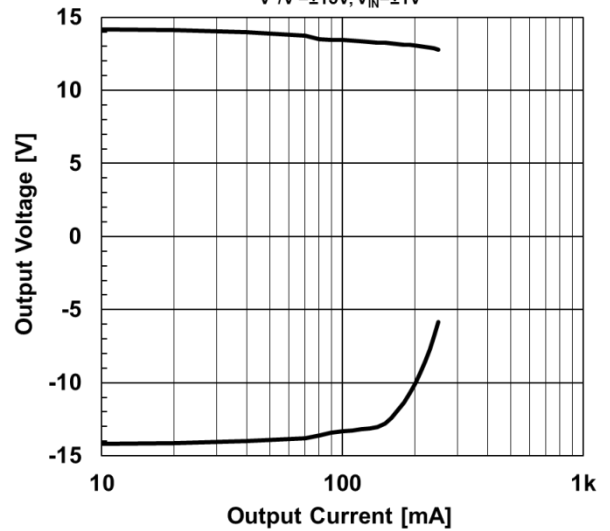

Output Voltage vs. Load Resistance
 $V^+/V^-=\pm 15V, V_{IN}=\pm 1V$

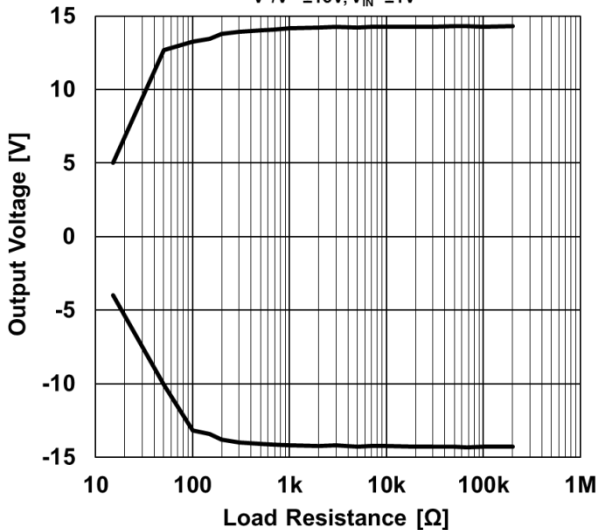

GBW vs. Temperature

$V^+/V^-=\pm 15V, f=10kHz, A_v=80dB, R_f=200k, R_g=20$

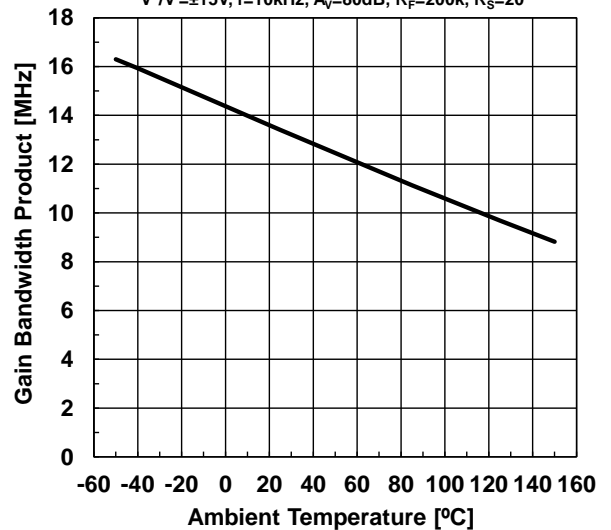

■ TYPICAL CHARACTERISTICS

Voltage Gain vs. Frequency
 $V^+/V^- = \pm 15V$, $R_F = 200k$, $R_S = 20$, $T_a = 27^\circ C$

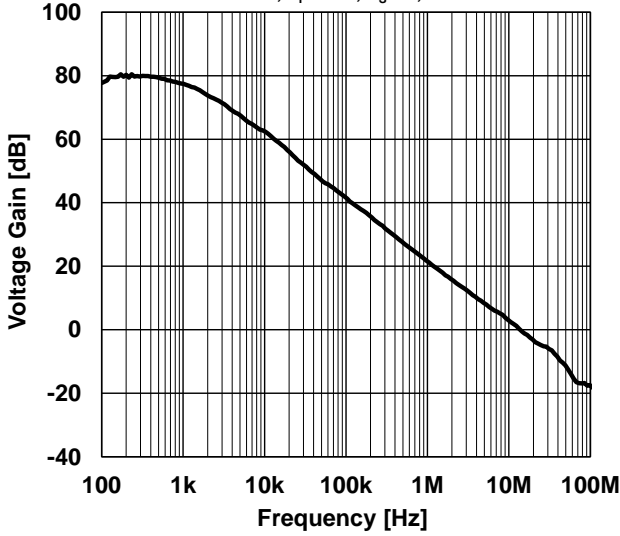

Voltage Gain · Phase vs. Frequency
 $V^+/V^- = \pm 15V$, $A_v = 40dB$, $R_F = 2k$, $R_S = 20$, $R_G = 50$, $C_I = 10pF$

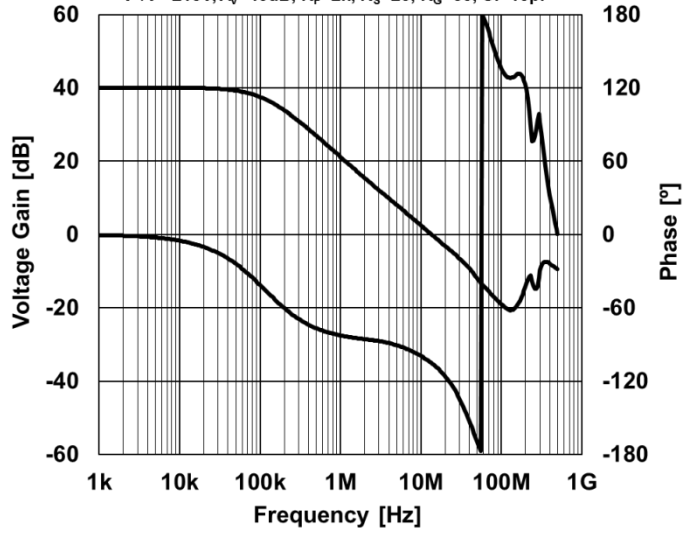

Voltage Gain · Phase vs. Frequency (CI=330pF)
 $V^+/V^- = \pm 15V$, $A_v = 40dB$, $R_F = 2k$, $R_S = 20$, $R_G = 50$, $C_I = 330pF$

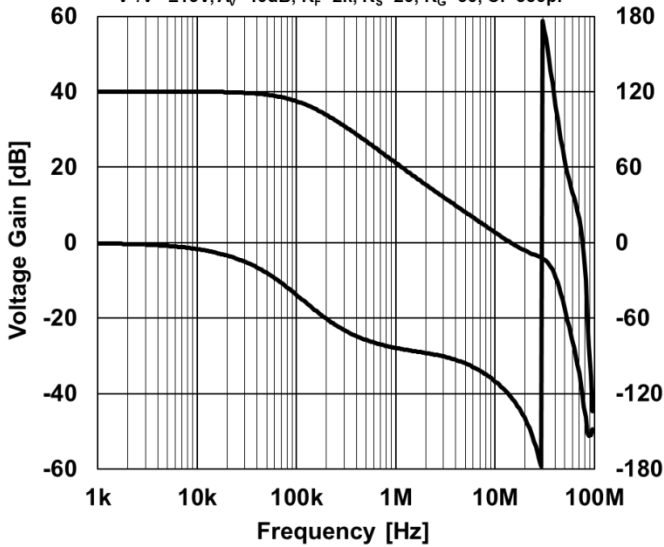

Voltage Noise Density vs. Frequency
 $V^+/V^- = \pm 15V$, $R_F = 2k$, $R_S = 20$, $T_a = 25^\circ C$

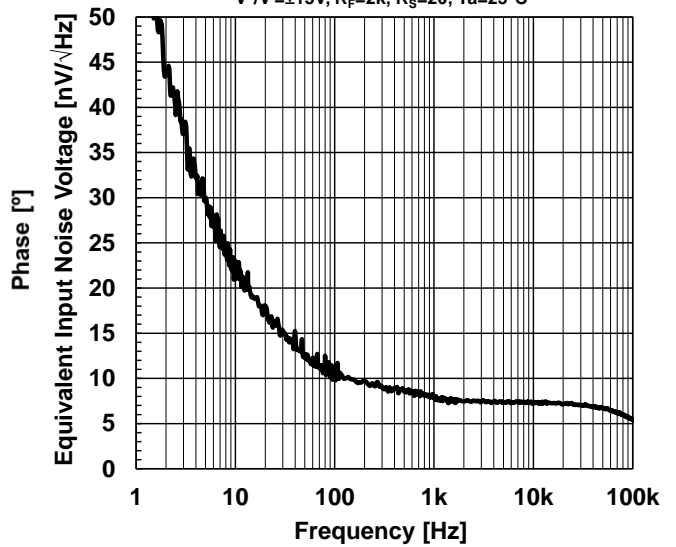

THD+N vs. Output Voltage
 $V^+/V^- = \pm 15V$, $R_1 = 550$, $R_2 = 5k$, $R_3 = 50$, $BPF: 400-20kHz$

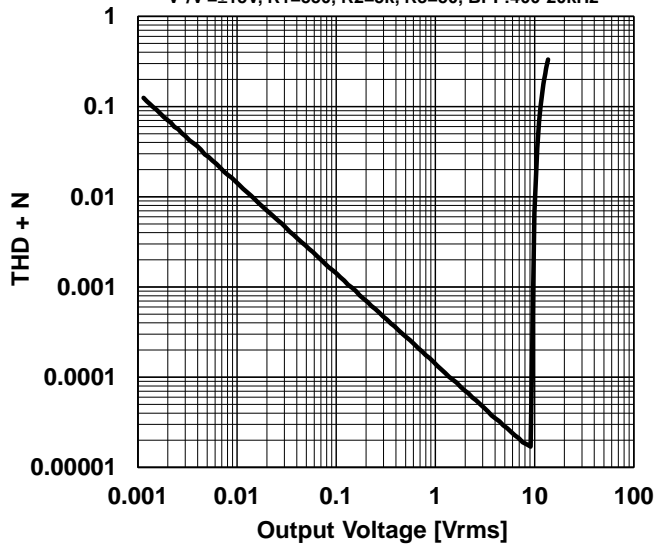

Slew Rate vs. Temperature
 $V^+/V^- = \pm 15V$, $V_{IN} = 2Vp-p$, $R_I = 2k$, $C_I = 10p$

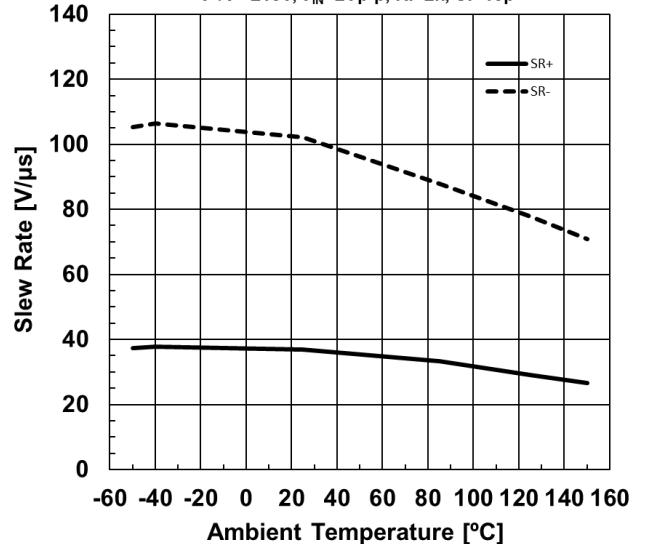

■PACKAGE OUTLINE
DIP8(MUSES)

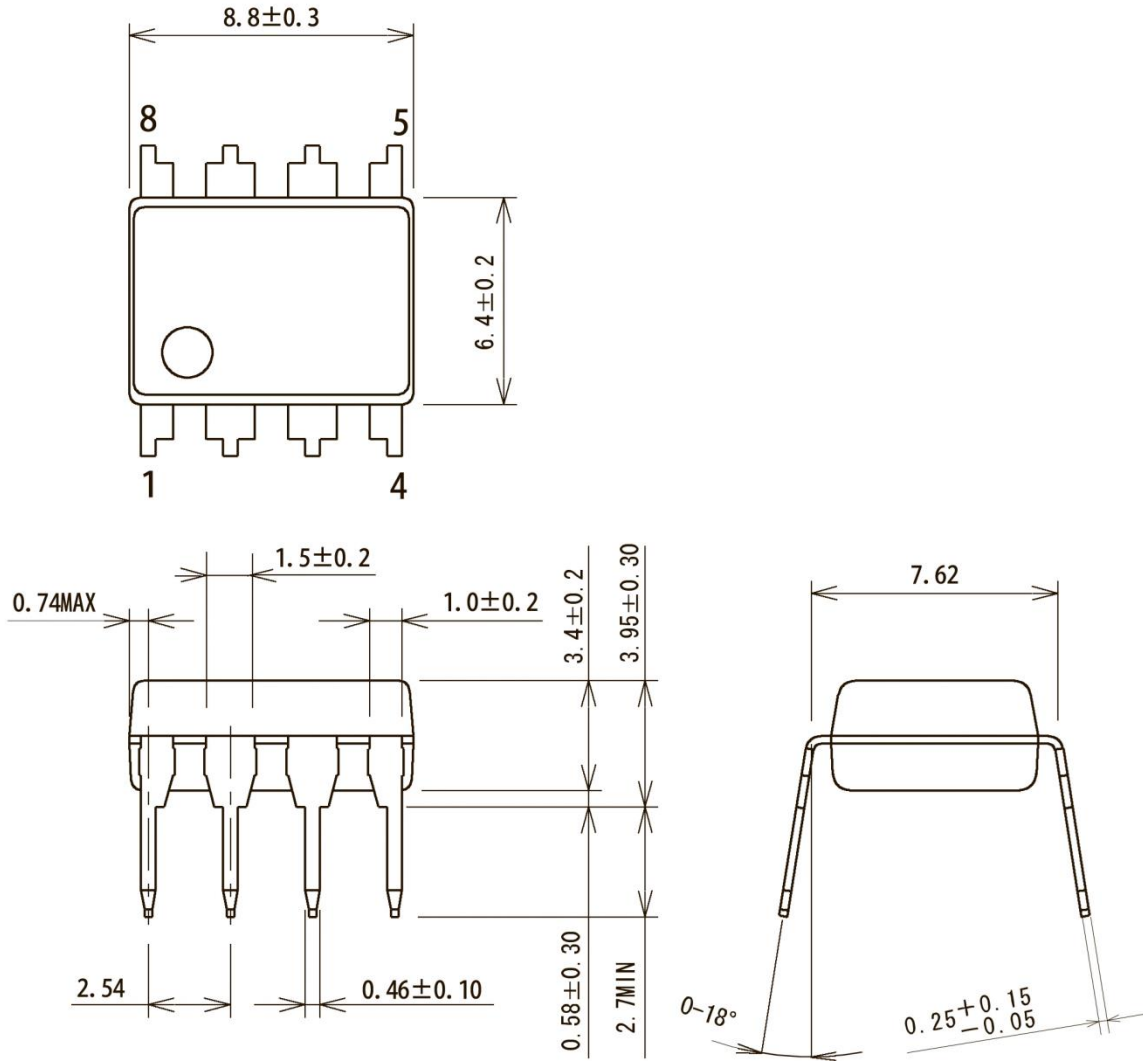

■PACKING SPECIFICATION

Plastic Tube Container Dimensions

DIP8(MUSES) packages are packed in the plastic tube container. The dimensions are mentioned as follows.

Plastic Tube Container dimensions for DIP8(MUSES)

Symbol	DIP8 (Carbon tube)
H	10.6mm
L	110mm
W	13.2mm
Material	PS Carbon
Stopper	Rubber Knob
Contents	10pcs

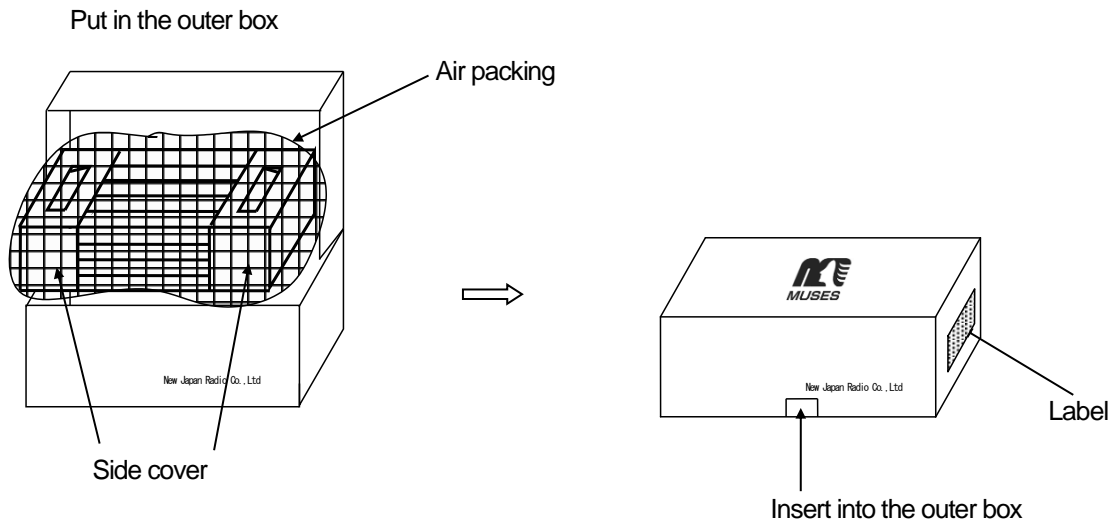
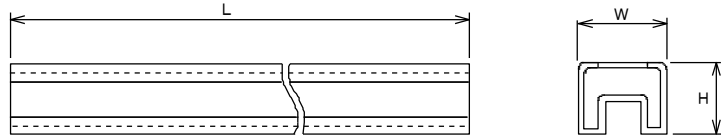

■RECOMMENDED MOUNTING METHOD

FLOW SOLDERING METHOD

* flow soldering procedure

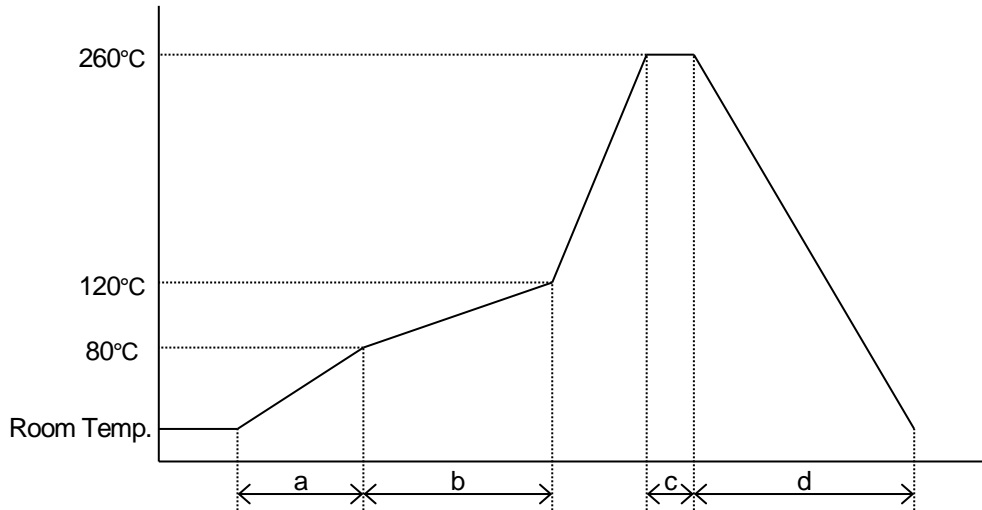

- a: Temperature ramping rate : 1 to 7°C /s
- b: Pre-heating temperature : 80 to 120°C
Pre-heating time : 60 to 120s
- c: Peak temperature : not exceeding 260°C
Peak time : within 10s
- d: Temperature ramping rate : 1 to 7°C /s

The temperature indicates at the surface of mold package.

IRON SOLDERING METHOD

* Iron Soldering conditions

Temperature of Iron: not exceeding 350°C

Soldering time: within 3s (At 1 lead)

■PRECAUTION FOR COUNTERFEIT SEMICONDUCTOR PRODUCTS

We have recently detected many counterfeit semiconductor products that have very similar appearances to our operational amplifier “MUSES” in the world-wide market. In most cases, it is hard to distinguish them from our regular products by their appearance, and some of them have very poor quality and performance.

They can not provide equivalent quality of our regular product, and they may cause breakdowns or malfunctions if used in your systems or applications.

We would like our customers to purchase “MUSES” through our official sales channels : our sales branches, sales subsidiaries and distributors.

Please note that we hold no responsibilities for any malfunctions or damages caused by using counterfeit products. We would appreciate your understanding.

[CAUTION]

1. New JRC strives to produce reliable and high quality semiconductors. New JRC's semiconductors are intended for specific applications and require proper maintenance and handling. To enhance the performance and service of New JRC's semiconductors, the devices, machinery or equipment into which they are integrated should undergo preventative maintenance and inspection at regularly scheduled intervals. Failure to properly maintain equipment and machinery incorporating these products can result in catastrophic system failures
2. The specifications on this datasheet are only given for information without any guarantee as regards either mistakes or omissions. The application circuits in this datasheet are described only to show representative usages of the product and not intended for the guarantee or permission of any right including the industrial rights. All other trademarks mentioned herein are property of their respective companies.
3. To ensure the highest levels of reliability, New JRC products must always be properly handled. The introduction of external contaminants (e.g. dust, oil or cosmetics) can result in failures of semiconductor products.
4. New JRC offers a variety of semiconductor products intended for particular applications. It is important that you select the proper component for your intended application. You may contact New JRC's Sale's Office if you are uncertain about the products listed in this catalog.
5. Special care is required in designing devices, machinery or equipment which demand high levels of reliability. This is particularly important when designing critical components or systems whose failure can foreseeably result in situations that could adversely affect health or safety. In designing such critical devices, equipment or machinery, careful consideration should be given to amongst other things, their safety design, fail-safe design, back-up and redundancy systems, and diffusion design.
6. The products listed in the catalog may not be appropriate for use in certain equipment where reliability is critical or where the products may be subjected to extreme conditions. You should consult our sales office before using the products in any of the following types of equipment.

Aerospace Equipment
 Equipment Used in the Deep sea
 Power Generator Control Equipment (Nuclear, Steam, Hydraulic)
 Life Maintenance Medical Equipment
 Fire Alarm/Intruder Detector
 Vehicle Control Equipment (airplane, railroad, ship, etc.)
 Various Safety devices

7. New JRC's products have been designed and tested to function within controlled environmental conditions. Do not use products under conditions that deviate from methods or applications specified in this catalog. Failure to employ New JRC products in the proper applications can lead to deterioration, destruction or failure of the products. New JRC shall not be responsible for any bodily injury, fires or accident, property damage or any consequential damages resulting from misuse or misapplication of its products. Products are sold without warranty of any kind, either express or implied, including but not limited to any implied warranty of merchantability or fitness for a particular purpose.
8. Warning for handling Gallium and Arsenic(GaAs) Products (Applying to GaAs MMIC, Photo Reflector). This Products uses Gallium(Ga) and Arsenic(As) which are specified as poisonous chemicals by law. For the prevention of a hazard, do not burn, destroy, or process chemically to make them as gas or power. When the product is disposed, please follow the related regulation and do not mix this with general industrial waste or household waste.
9. The product specifications and descriptions listed in this catalog are subject to change at any time, without notice.



X-ON Electronics

Largest Supplier of Electrical and Electronic Components

Click to view similar products for [Operational Amplifiers - Op Amps](#) category:

Click to view products by [Nisshinbo](#) manufacturer:

Other Similar products are found below :

[NCV33072ADR2G](#) [LM358SNG](#) [430227FB](#) [UPC824G2-A](#) [LT1678IS8](#) [042225DB](#) [058184EB](#) [UPC822G2-A](#) [UPC259G2-A](#) [UPC258G2-A](#)
[NCV33202DMR2G](#) [NTE925](#) [AZV358MTR-G1](#) [AP4310AUMTR-AG1](#) [HA1630D02MMEL-E](#) [HA1630S01LPEL-E](#) [SCY33178DR2G](#)
[NJU77806F3-TE1](#) [NCV5652MUTWG](#) [NCV20034DR2G](#) [LM324EDR2G](#) [LM2902EDR2G](#) [NTE7155](#) [NTE778S](#) [NTE871](#) [NTE924](#) [NTE937](#)
[MCP6V17T-E/MNY](#) [MCP6V19-E/ST](#) [MXD8011HF](#) [MCP6V17T-E/MS](#) [SCY6358ADR2G](#) [ADA4523-1BCPZ](#) [LTC2065HUD#PBF](#)
[ADA4523-1BCPZ-RL7](#) [NJM2904CRB1-TE1](#) [2SD965T-R](#) [RS6332PXK](#) [BDM8551](#) [BDM321](#) [MD1324](#) [COS8052SR](#) [COS8552SR](#)
[COS8554SR](#) [COS2177SR](#) [COS2353SR](#) [COS724TR](#) [ASOPD4580S-R](#) [RS321BKXF](#) [ADA4097-1HUIZ-RL7](#)