

GPS Front-End Module

■ GENERAL DESCRIPTION

The NJG1156PCD is a front-end module (FEM) designed for GPS applications. The NJG1156PCD offers high gain, low noise figure, high linearity and very high out-band rejection characteristics brought by included high performance pre- SAW filter, low noise amplifier (LNA) and post- SAW filter. The NJG1156PCD can be operated from 1.5V to 3.3V single voltage.

The NJG1156PCD offers very small mounting area by included two SAW filters, only two external components and very small HFFP10-CD package that is 2.5x2.5mm.

■ PACKAGE OUTLINE

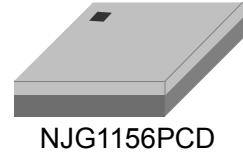

NJG1156PCD

■ FEATURES

- Low supply voltage 1.8/ 2.8V typ.
 - Low current consumption 2.6/3.3mA typ. @V_{DD}=1.8/ 2.8V, V_{CTL}=1.8V
 - High gain 0.1μA typ. @V_{DD}=1.8/ 2.8V, V_{CTL}=0V (Stand-by mode)
 - Low noise figure 17.5/18.5dB typ. @V_{DD}=1.8/ 2.8V, V_{CTL}=1.8V, f=1575MHz
 - High out band rejection 1.60/1.55dB typ. @V_{DD}=1.8/ 2.8V, V_{CTL}=1.8V, f=1575MHz
 - Small package size 85dBc typ. @f=704 to 915MHz, relative to 1575MHz
 - RoHS compliant and Halogen Free, MSL1 75dBc typ. @f=1710 to 1980MHz, relative to 1575MHz
 - 78dBc typ. @f=1526 to 1536MHz, 1627 to 1680MHz, relative to 1575MHz
- HFFP10-CD: 2.5mmx2.5mmx0.63mm max.

■ PIN CONFIGURATION

(Top View)

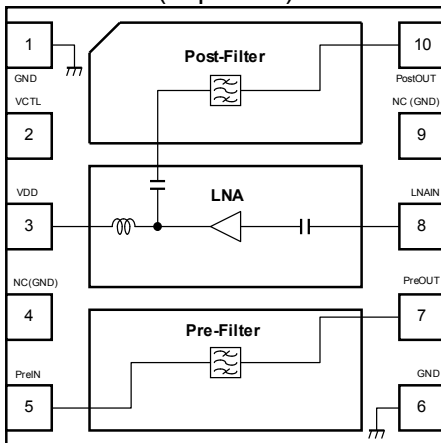

Pin connection

1. GND
2. VCTL
3. VDD
4. NC(GND)
5. PreIN
6. GND
7. PreOUT
8. LNAIN
9. NC(GND)
10. PostOUT

Exposed pad: GND

■ BLOCK DIAGRAM

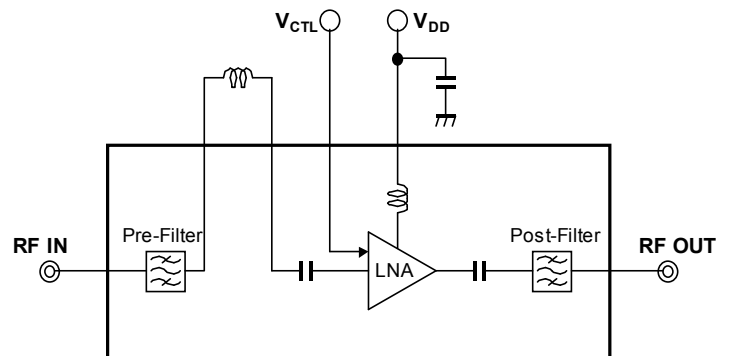

■ TRUTH TABLE

“H”=V_{CTL}(H), “L”=V_{CTL}(L)

VCTL	Mode
H	Active mode
L	Stand-by mode

Note: Specifications and description listed in this datasheet are subject to change without notice.

NJG1156PCD

■ ABSOLUTE MAXIMUM RATINGS

$T_a=+25^{\circ}\text{C}$, $Z_s=Z_l=50\Omega$

PARAMETERS	SYMBOL	CONDITIONS	RATINGS	UNITS
Supply voltage	V_{DD}		5.0	V
Control voltage	V_{CTL}		5.0	V
Input power	P_{IN} (inband)	$V_{DD}=2.8\text{V}$, $f=1575, 1597$ to 1606MHz	+15	dBm
	P_{IN} (outband)	$V_{DD}=2.8\text{V}$, $f=50$ to $1460, 1710$ to 4000MHz	+27	dBm
Power dissipation	P_D	4-layer FR4 PCB with through-hole ($101.5 \times 114.5\text{mm}$), $T_i=100^{\circ}\text{C}$	510	mW
Operating temperature	T_{opr}		-40 to +85	$^{\circ}\text{C}$
Storage temperature	T_{stg}		-40 to +100	$^{\circ}\text{C}$

■ ELECTRICAL CHARACTERISTICS 1 (DC)

(General conditions: $T_a=+25^{\circ}\text{C}$)

PARAMETER	SYMBOL	CONDITIONS	MIN	TYP	MAX	UNITS
Supply Voltage	V_{DD}		1.5	-	3.3	V
Control Voltage (High)	$V_{CTL(H)}$		1.5	1.8	3.3	V
Control Voltage (Low)	$V_{CTL(L)}$		0	0	0.3	V
Supply Current 1	I_{DD1}	RF OFF, $V_{DD}=2.8\text{V}$, $V_{CTL}=1.8\text{V}$	-	3.3	6.4	mA
Supply Current 2	I_{DD2}	RF OFF, $V_{DD}=1.8\text{V}$, $V_{CTL}=1.8\text{V}$	-	2.6	5.9	mA
Supply Current 3	I_{DD3}	RF OFF, $V_{DD}=2.8\text{V}$, $V_{CTL}=0\text{V}$	-	0.1	5.0	μA
Supply Current 4	I_{DD4}	RF OFF, $V_{DD}=1.8\text{V}$, $V_{CTL}=0\text{V}$	-	0.1	5.0	μA
Control Current	I_{CTL}	$V_{CTL}=1.8\text{V}$	-	5.0	15.0	μA

■ ELECTRICAL CHARACTERISTICS 2 (RF)

General conditions: $V_{DD}=2.8V$, $V_{CTL}=1.8V$, $f_{RF}=1575MHz$, $T_a=+25^{\circ}C$, $Z_s=Z_l=50\Omega$, with application circuit

PARAMETER	SYMBOL	CONDITIONS	MIN	TYP	MAX	UNITS
Small Signal Gain1	Gain1	f=1575MHz, Exclude PCB, Connector Losses (0.19dB)	17.3	18.5	-	dB
Noise Figure1	NF1	f=1575MHz, Exclude PCB, Connector Losses (0.09dB)	-	1.55	2.05	dB
Input Power at 1dB Gain Compression Point 1	P-1dB(IN)1	f=1575MHz	-	-15.0	-	dBm
Input 3rd Order Intercept Point 1	IIP3_1	f1=1575MHz, f2=f1+/-1MHz, Pin=-30dBm	-	-4.0	-	dBm
Out of Band Input 2nd Order Intercept Point 1	IIP2_OB1	f1=824.6MHz at +15dBm, f2=2400MHz at +15dBm, fmeas=1575.4MHz	-	+87	-	dBm
Out of Band Input 3rd Order Intercept Point 1	IIP3_OB1	f1=1712.7MHz at +15dBm, f2=1850MHz at +15dBm, fmeas=1575.4MHz	-	+55	-	dBm
700MHz Harmonics1	2fo1	Input jammer tone: 787.76MHz at +15dBm Measure the harmonic tone at 1575.52MHz	-	-43	-	dBm
Out-of-Band Input Power 1dB Compression 1	P-1dB(IN)_OB1-1	fjam=900MHz, fmeas=1575MHz at Pin=-40dBm	-	+24	-	dBm
	P-1dB(IN)_OB1-2	fjam=1710MHz, fmeas=1575MHz at Pin=-40dBm	-	+24	-	dBm
Low Band Rejection 1	BR_L1	f=704 to 915MHz, relative to 1575MHz	75	85	-	dBc
High Band Rejection 1	BR_H1	f=1710 to 1980MHz, relative to 1575MHz	65	75	-	dBc
WLAN Band Rejection 1	BR_W1	f=2400 to 2500MHz, relative to 1575MHz	60	72	-	dBc
LS Rejection1	BR_LS1	f=1526 to 1536MHz, 1627 to 1680MHz, relative to 1575MHz	-	78	-	dBc
RF IN Return Loss1	RLi1	f=1575MHz	-	6.5	-	dB
RF OUT Return Loss1	RLo1	f=1575MHz	-	20	-	dB

NJG1156PCD

■ ELECTRICAL CHARACTERISTICS 3 (RF)

General conditions: $V_{DD}=1.8V$, $V_{CTL}=1.8V$, $f_{RF}=1575MHz$, $T_a=+25^{\circ}C$, $Z_s=Z_l=50\Omega$, with application circuit

PARAMETER	SYMBOL	CONDITIONS	MIN	TYP	MAX	UNITS
Small Signal Gain ²	Gain ₂	f=1575MHz, Exclude PCB, Connector Losses (0.19dB)	15.8	17.5	-	dB
Noise Figure ²	NF ₂	f=1575MHz, Exclude PCB, Connector Losses (0.09dB)	-	1.6	2.2	dB
Input Power at 1dB Gain Compression Point ²	P-1dB(IN) ₂	f=1575MHz	-	-17.0	-	dBm
Input 3rd Order Intercept Point ²	IIP3_2	f1=1575MHz, f2=f1+/-1MHz, Pin=-30dBm	-	-6.0	-	dBm
Out of Band Input 2nd Order Intercept Point ²	IIP2_OB2	f1=824.6MHz at +15dBm, f2=2400MHz at +15dBm, fmeas=1575.4MHz	-	+87	-	dBm
Out of Band Input 3rd Order Intercept Point ²	IIP3_OB2	f1=1712.7MHz at +15dBm, f2=1850MHz at +15dBm, fmeas=1575.4MHz	-	+50	-	dBm
700MHz Harmonics ²	2fo ₂	Input jammer tone: 787.76MHz at +15dBm Measure the harmonic tone at 1575.52MHz	-	-43	-	dBm
Out-of-Band Input Power 1dB Compression ²	P-1dB(IN)_OB2-1	fjam=900MHz, fmeas=1575MHz at Pin=-40dBm	-	+24	-	dBm
	P-1dB(IN)_OB2-2	fjam=1710MHz, fmeas=1575MHz at Pin=-40dBm	-	+24	-	dBm
Low Band Rejection ²	BR_L2	f=704 to 915MHz, relative to 1575MHz	-	85	-	dBc
High Band Rejection ²	BR_H2	f=1710 to 1980MHz, relative to 1575MHz	-	75	-	dBc
WLAN Band Rejection ²	BR_W2	f=2400 to 2500MHz, relative to 1575MHz	-	72	-	dBc
LS Rejection ²	BR_LS2	f=1526 to 1536MHz, 1627 to 1680MHz, relative to 1575MHz	-	78	-	dBc
RF IN Return Loss ²	RLi ₂	f=1575MHz	-	6.5	-	dB
RF OUT Return Loss ²	RLo ₂	f=1575MHz	-	17	-	dB

■ TERMINAL INFORMATION

No.	SYMBOL	DESCRIPTION
1	GND	Ground terminal. This terminal should be connected to the ground plane as close as possible for excellent RF performance.
2	VCTL	Control voltage terminal.
3	VDD	Supply voltage terminal. Please connect bypass capacitor C1 with ground as close as possible.
4	NC(GND)	No connected terminal. This terminal is not connected with internal circuit. Please connect to the PCB ground Plane.
5	PreIN	RF input terminal. This terminal connects to input of pre-SAW filter.
6	GND	Ground terminal. This terminal should be connected to the ground plane as close as possible for excellent RF performance.
7	PreOUT	Pre-SAW filter output terminal. This terminal connects to LNAIN with L1.
8	LNAIN	RF input terminal. This terminal requires only a matching inductor L1, and does not require DC blocking capacitor because of integrated capacitor.
9	NC(GND)	No connected terminal. This terminal is not connected with internal circuit. Please connect to the PCB ground Plane.
10	PostOUT	RF output terminal. This terminal requires no DC blocking capacitor since this terminal has integrated SAW that also works as DC blocking capacitor in nature.
Exposed Pad	GND	Ground terminal.

NJG1156PCD

ELECTRICAL CHARACTERISTICS

Conditions: $V_{DD}=2.8V$, $V_{CTL}=1.8V$, $T_a=25^{\circ}C$, $Z_S=Z_I=50\Omega$, with application circuit

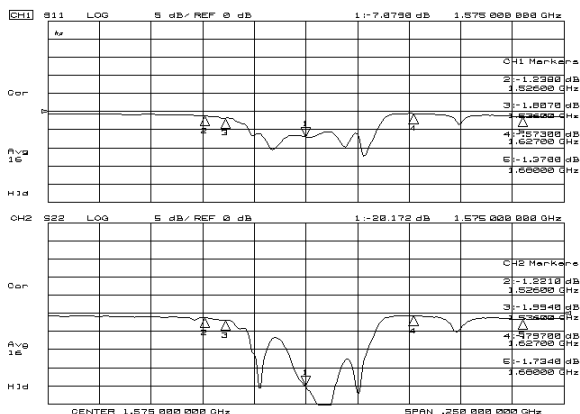

S11, S22

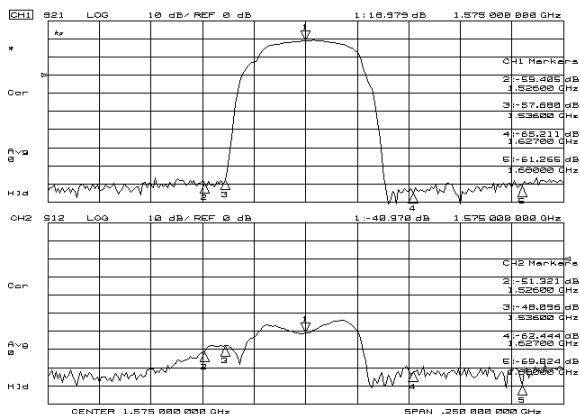

S21, S12

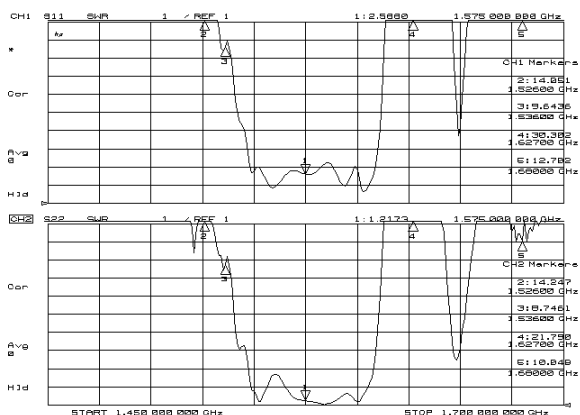

VSWR

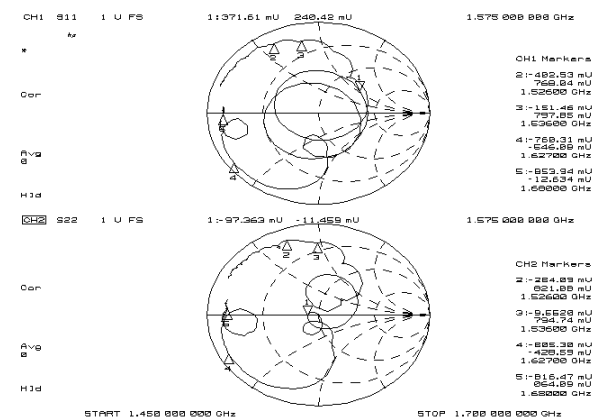

Zin, Zout

ELECTRICAL CHARACTERISTICS

Conditions: $V_{DD}=2.8V$, $V_{CTL}=1.8V$, $T_a=25^\circ C$, $Z_s=Z_l=50\Omega$, with application circuit

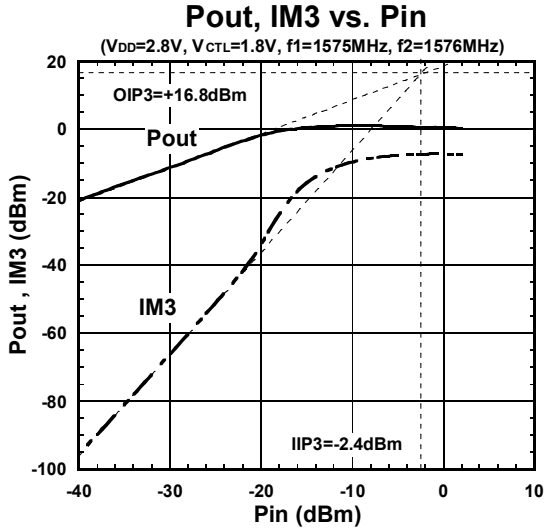
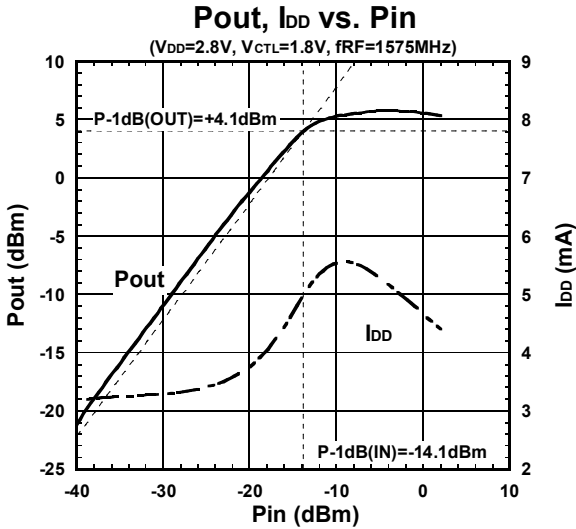
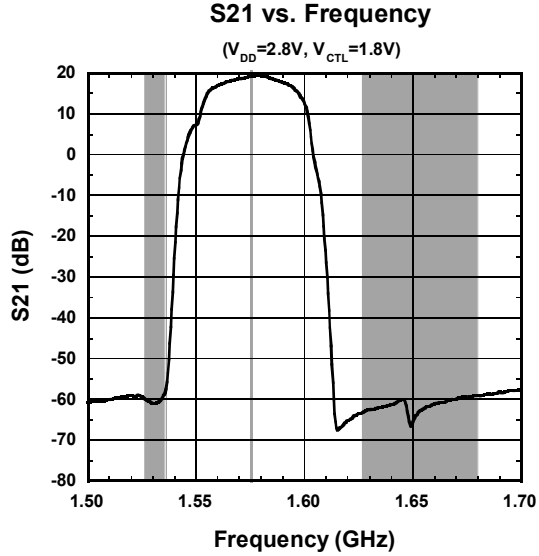
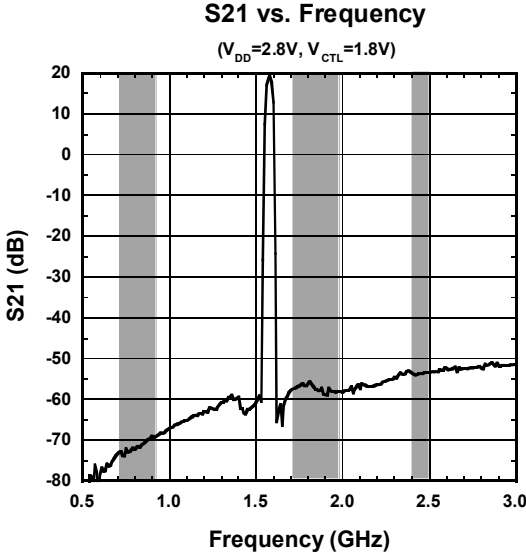
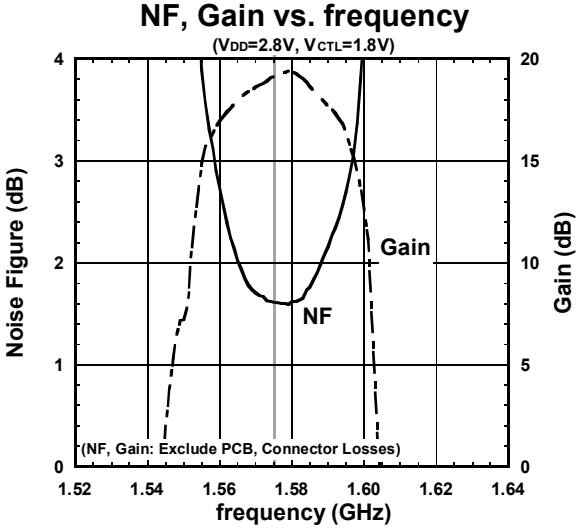

NJG1156PCD

ELECTRICAL CHARACTERISTICS

Conditions: $V_{DD}=2.8V$, $V_{CTL}=1.8V$, $T_a=25^\circ C$, $Z_s=Z_l=50\Omega$, with application circuit

Out-of-band P-1dB (fjam=900MHz)

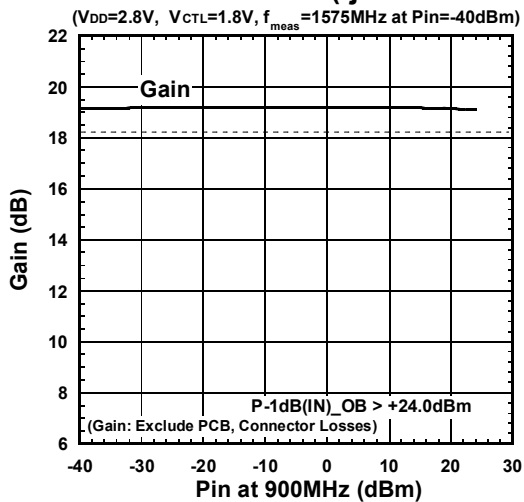

Out-of-band P-1dB (fjam=1710MHz)

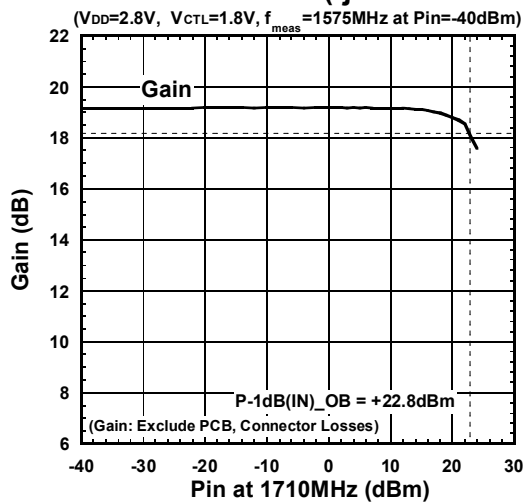

Out-of-band IIP2

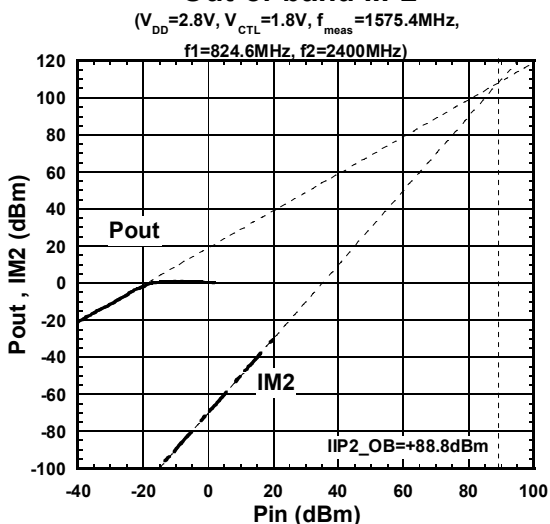

Out-of-band IIP3

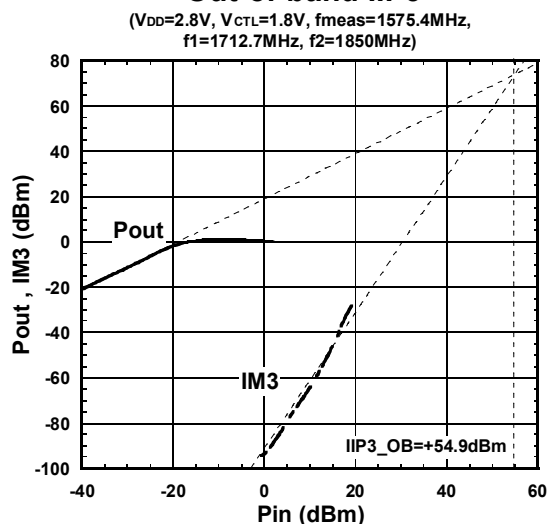

2nd Harmonics

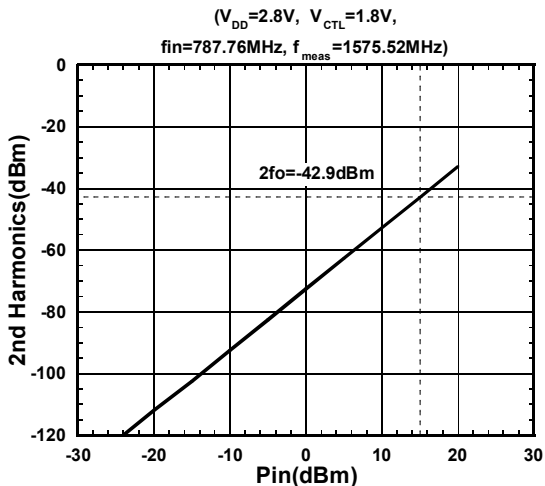

■ ELECTRICAL CHARACTERISTICS

Conditions: $V_{DD}=1.8V$, $V_{CTL}=1.8V$, $T_a=25^{\circ}C$, $Z_s=Z_l=50\Omega$, with application circuit

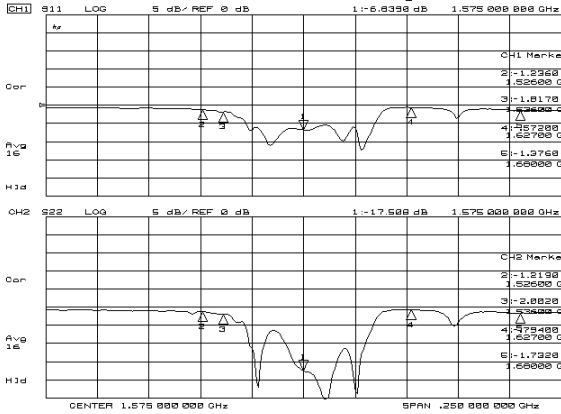

S11, S22

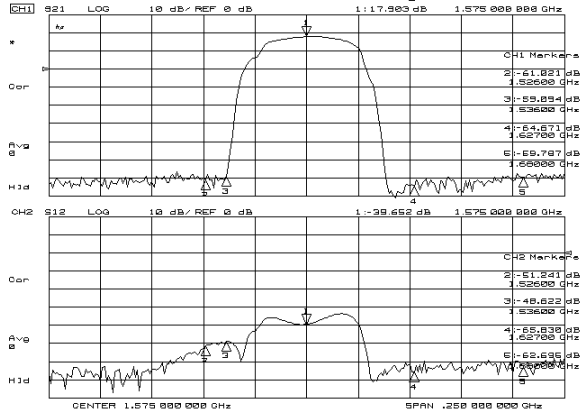

S21, S12

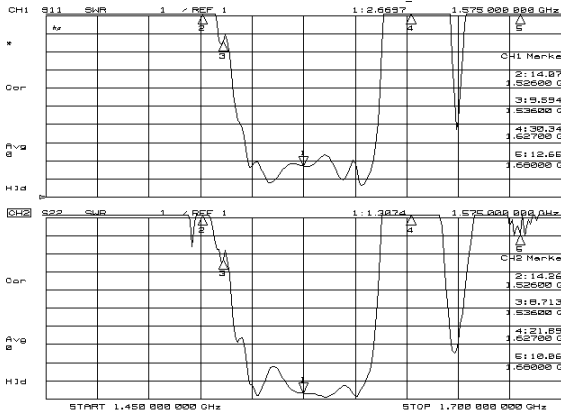

VSWR

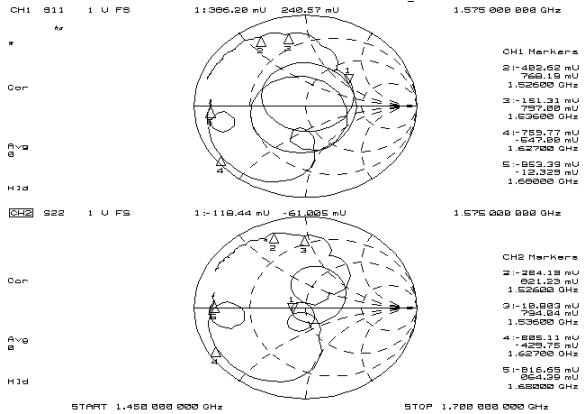

Zin, Zout

NJG1156PCD

■ ELECTRICAL CHARACTERISTICS

Conditions: $V_{DD}=1.8V$, $V_{CTL}=1.8V$, $T_a=25^\circ C$, $Z_s=Z_l=50\Omega$, with application circuit

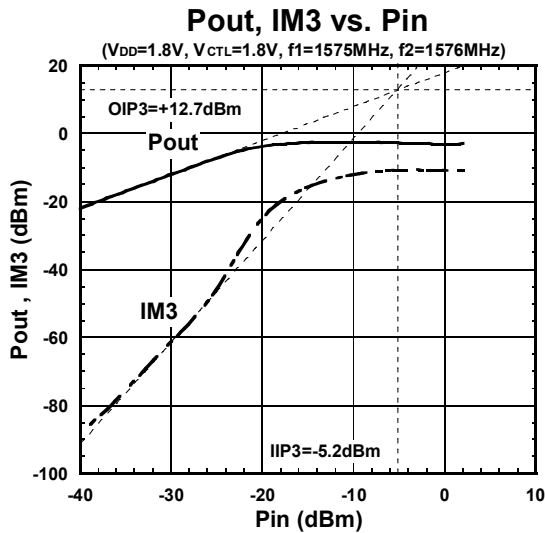
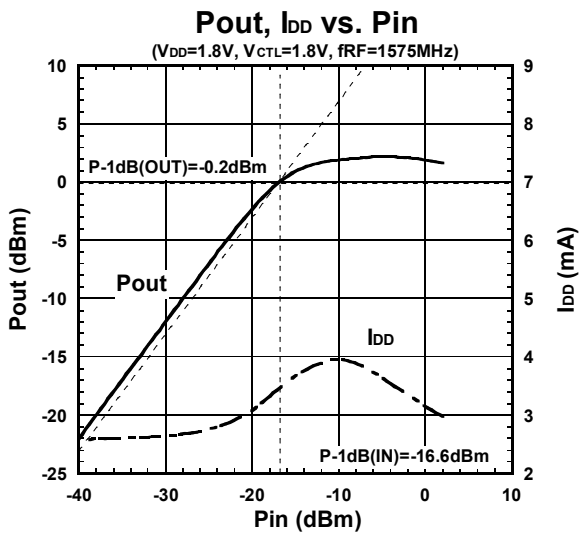
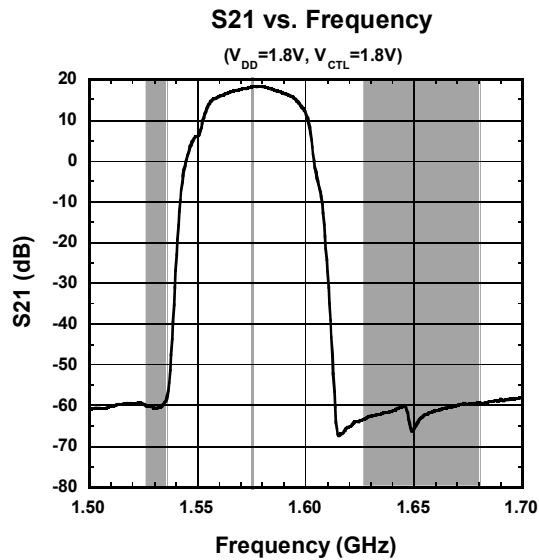
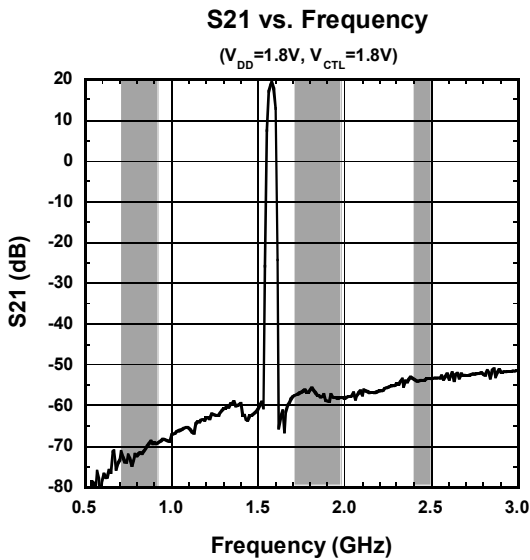
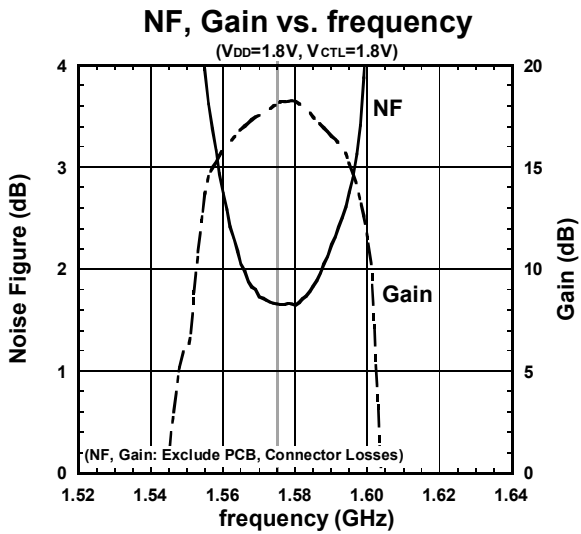

■ ELECTRICAL CHARACTERISTICS

Conditions: $V_{DD}=1.8V$, $V_{CTL}=1.8V$, $T_a=25^\circ C$, $Z_s=Z_l=50\Omega$, with application circuit

Out-of-band P-1dB (fjam=900MHz)

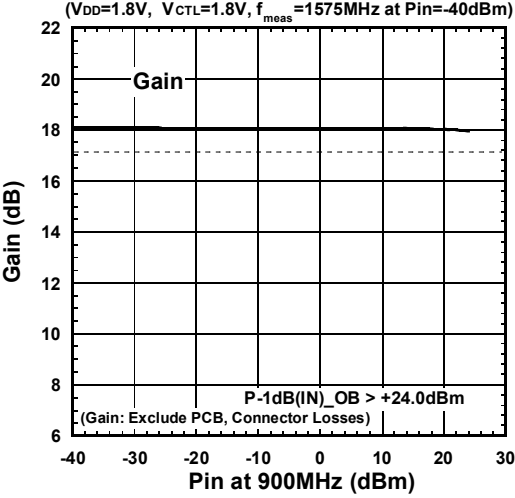

Out-of-band P-1dB (fjam=1710MHz)

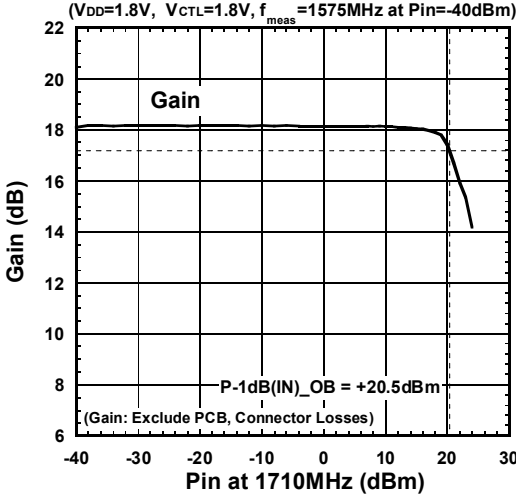

Out-of-band IIP2

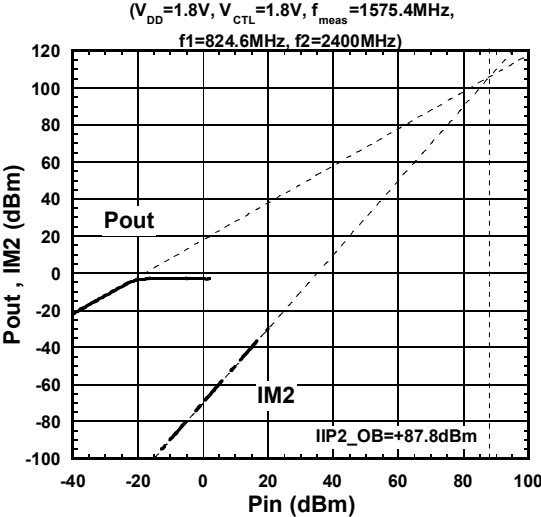

Out-of-band IIP3

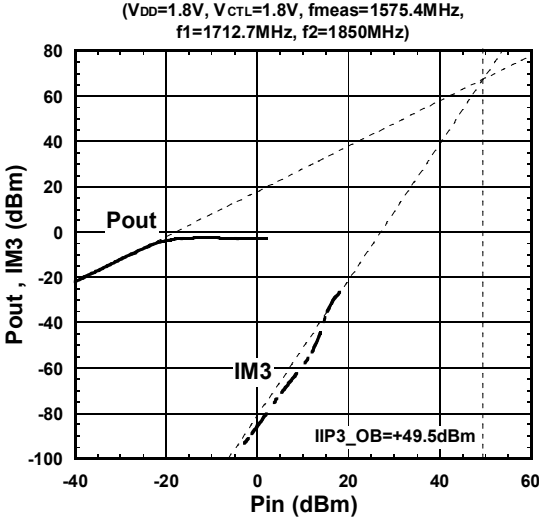

2nd Harmonics

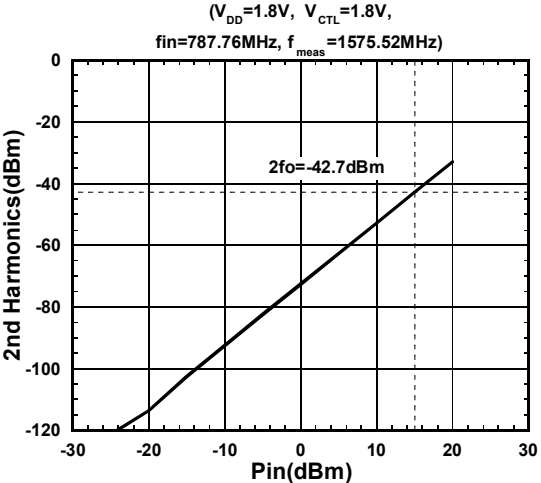

NJG1156PCD

■ ELECTRICAL CHARACTERISTICS

Conditions: $V_{DD}=2.8V$, $V_{CTL}=1.8V$, $Z_s=Z_l=50\Omega$, with application circuit

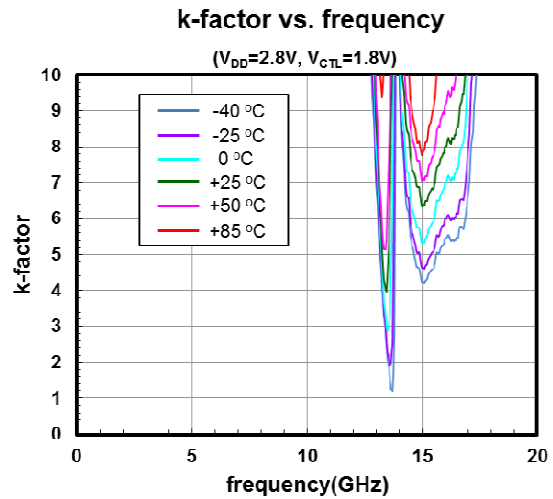
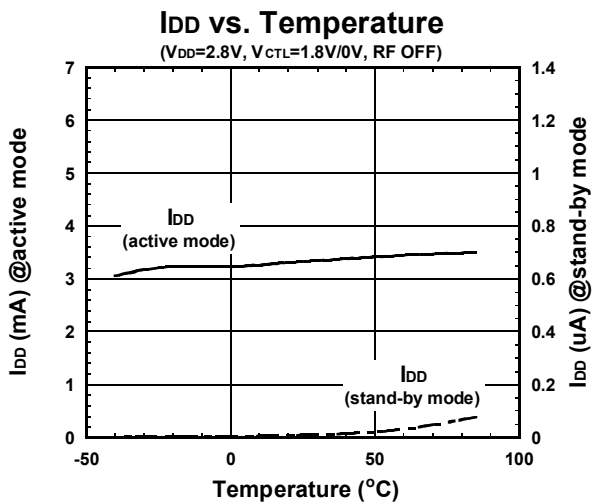
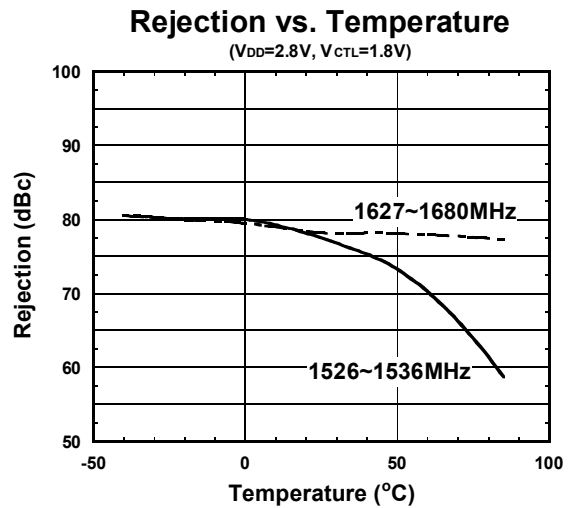
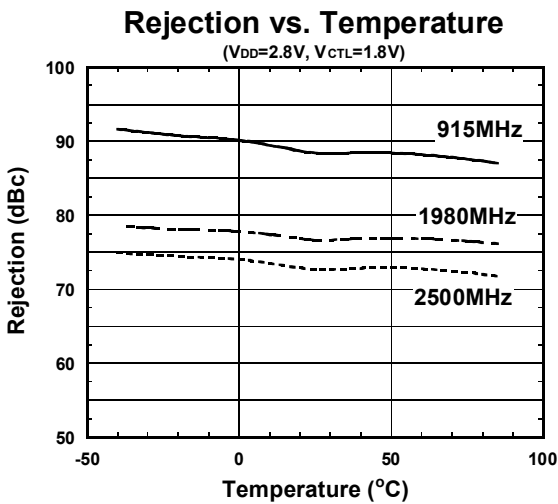
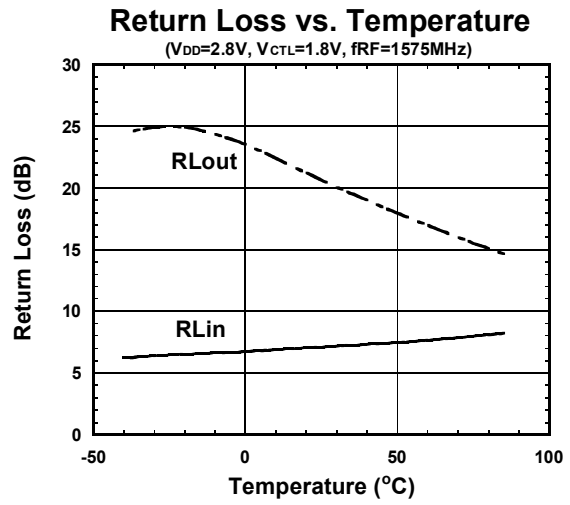
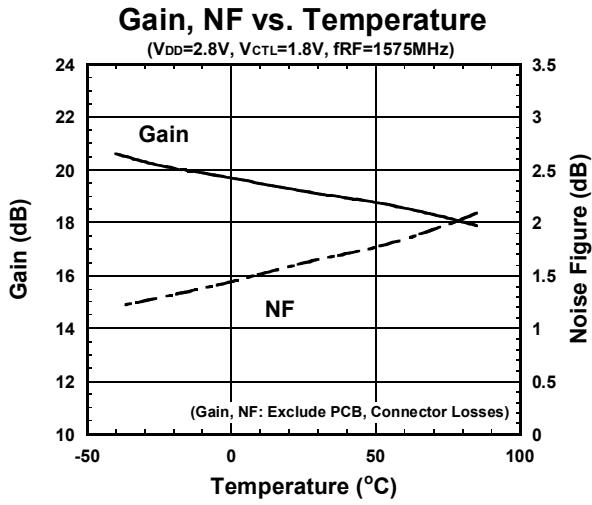

■ ELECTRICAL CHARACTERISTICS

Conditions: $V_{DD}=2.8V$, $V_{CTL}=1.8V$, $Z_s=Z_l=50\Omega$, with application circuit

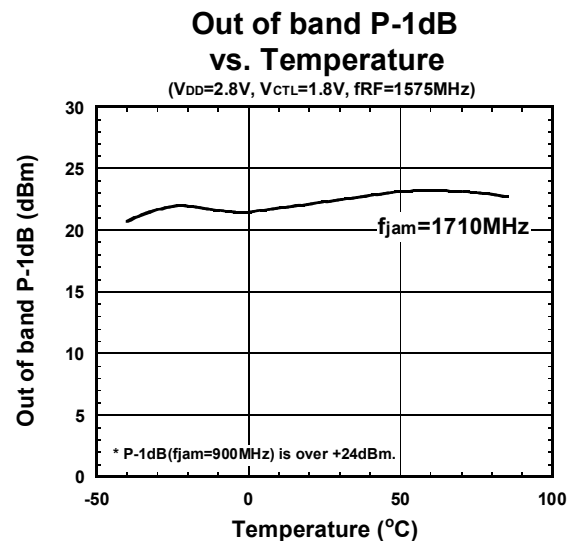
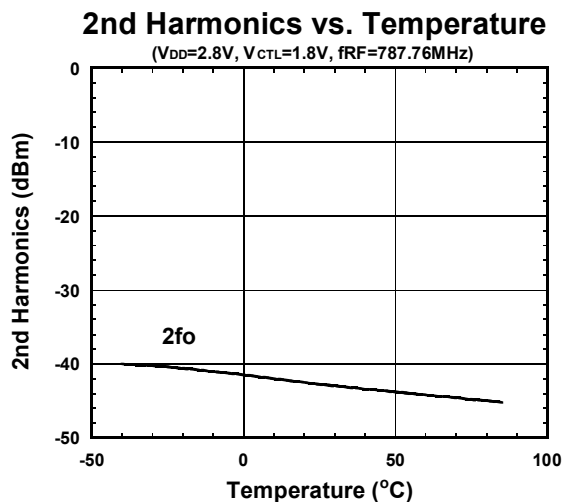
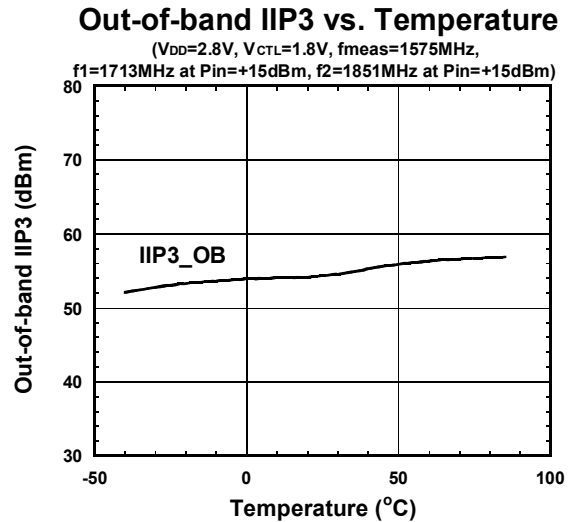
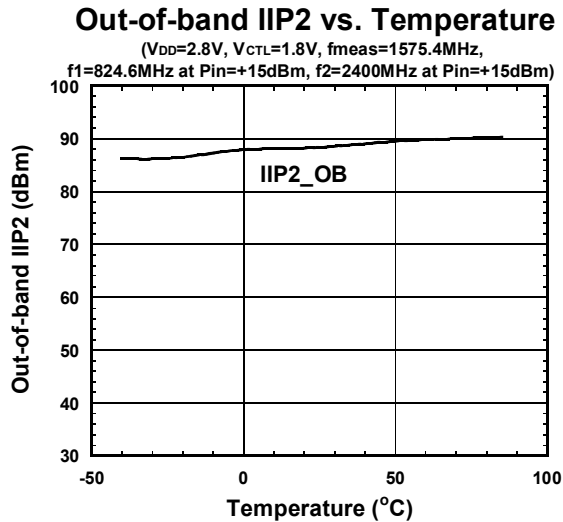
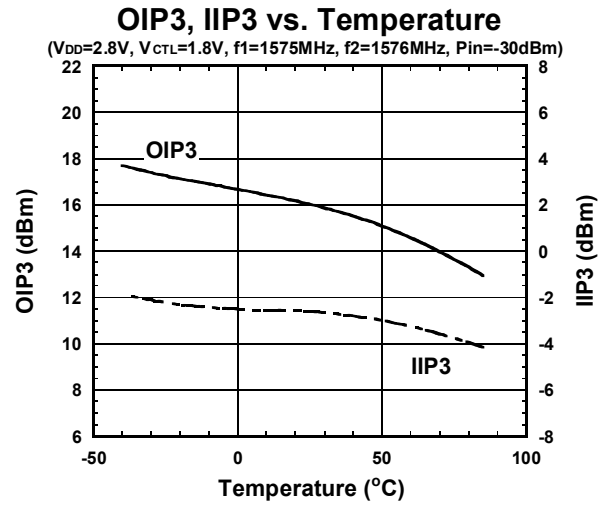
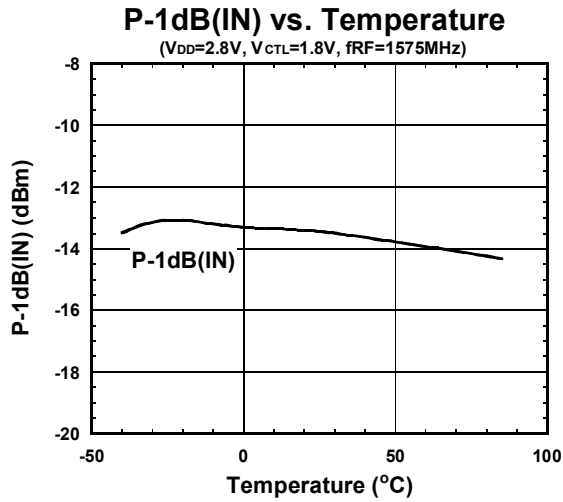

NJG1156PCD

■ ELECTRICAL CHARACTERISTICS

Conditions: $V_{CTL}=1.8V$, $T_a=25^{\circ}C$, $Z_s=Z_l=50\Omega$, with application circuit

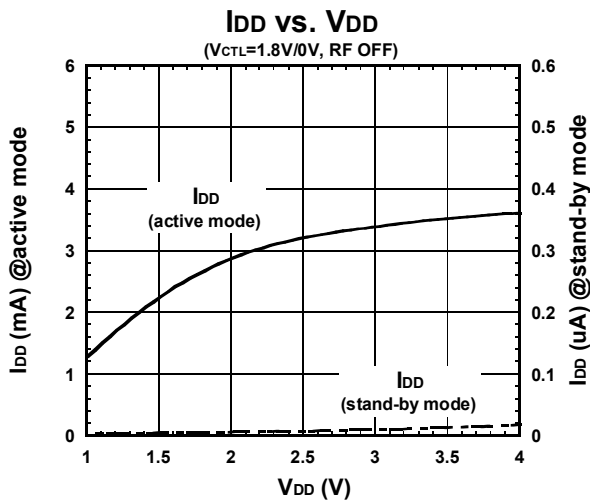
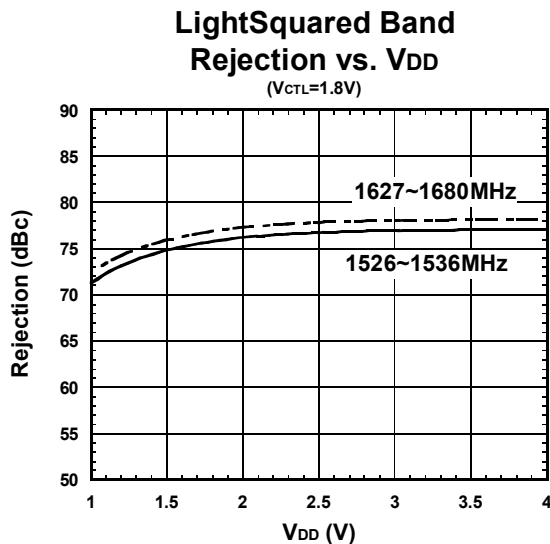
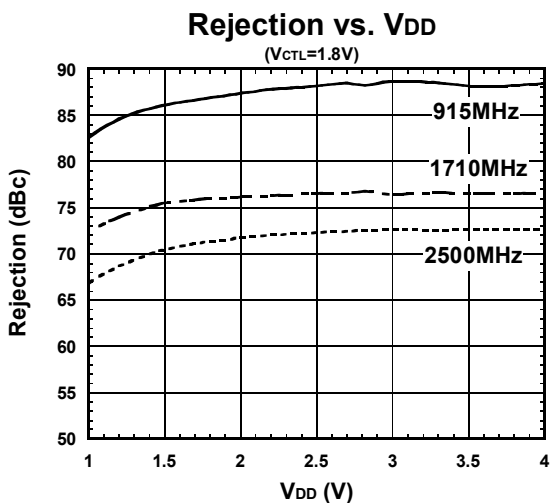
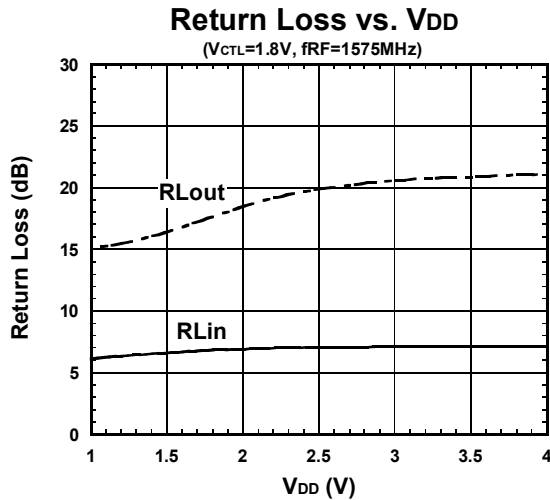
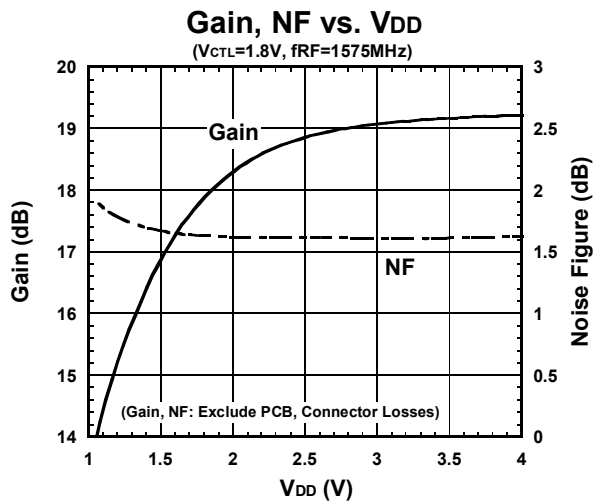

■ ELECTRICAL CHARACTERISTICS

Conditions: $V_{CTL}=1.8V$, $T_a=25^\circ C$, $Z_s=Z_l=50\Omega$, with application circuit

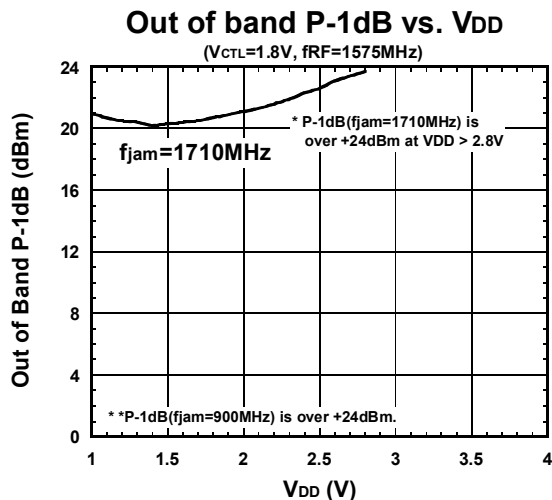
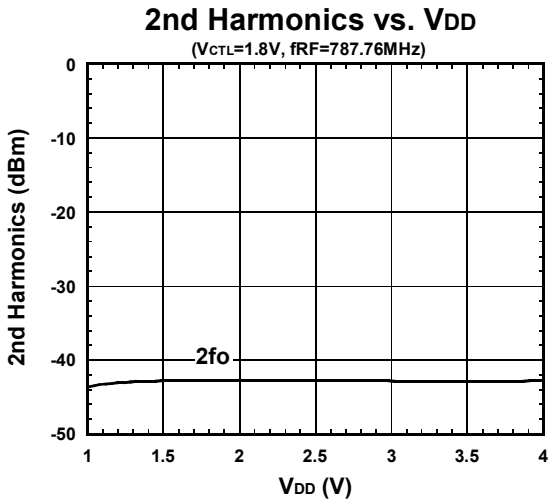
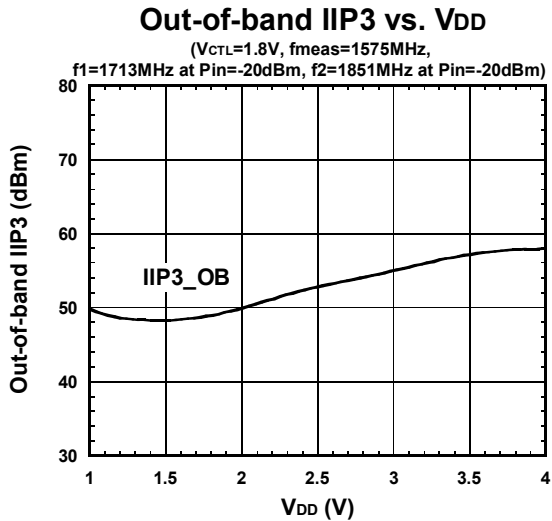
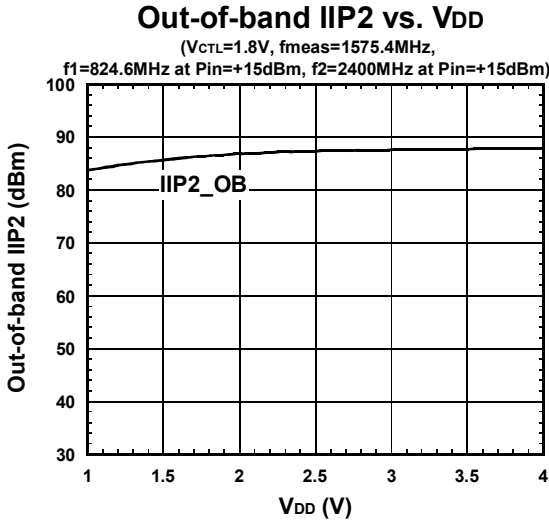
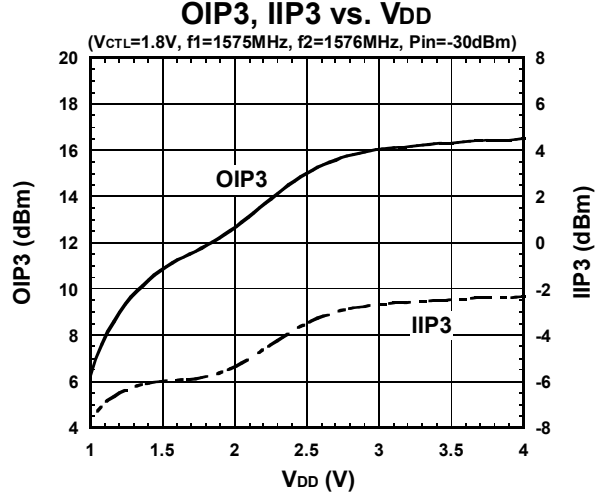
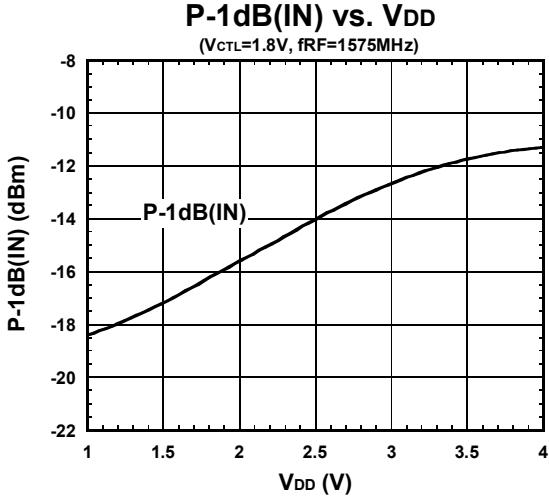

NJG1156PCD

APPLICATION CIRCUIT

(Top View)

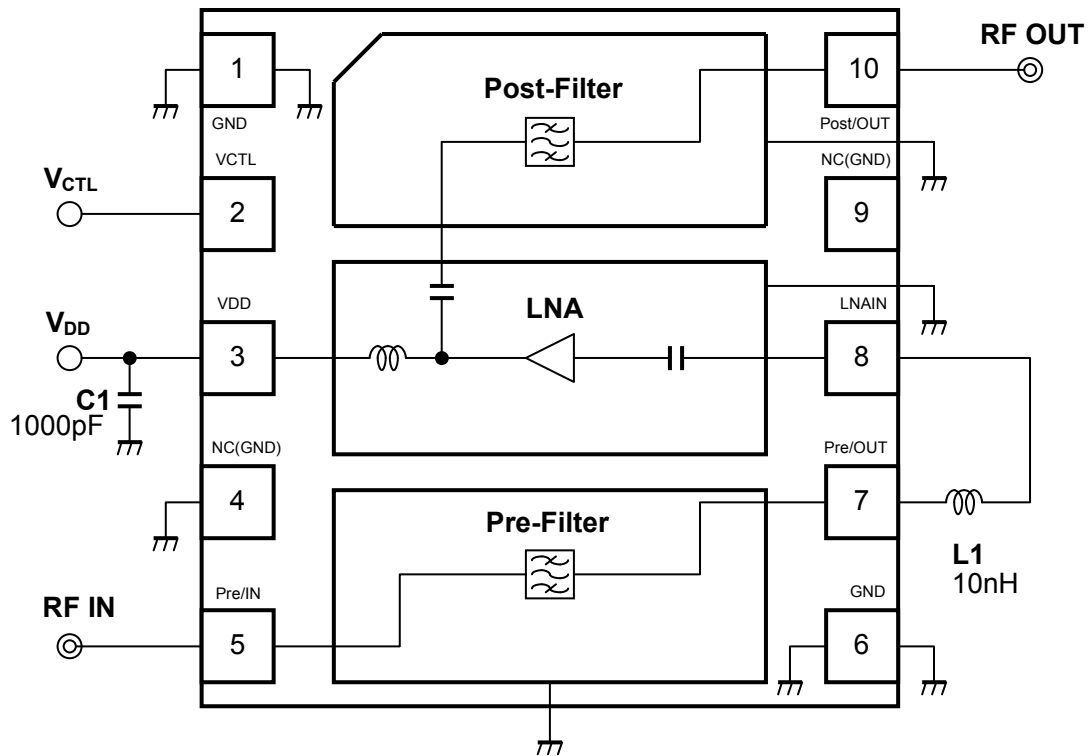

Parts list

Parts ID	Manufacture
L1	LQW15A Series (MURATA)
C1	GRM03 Series (MURATA)



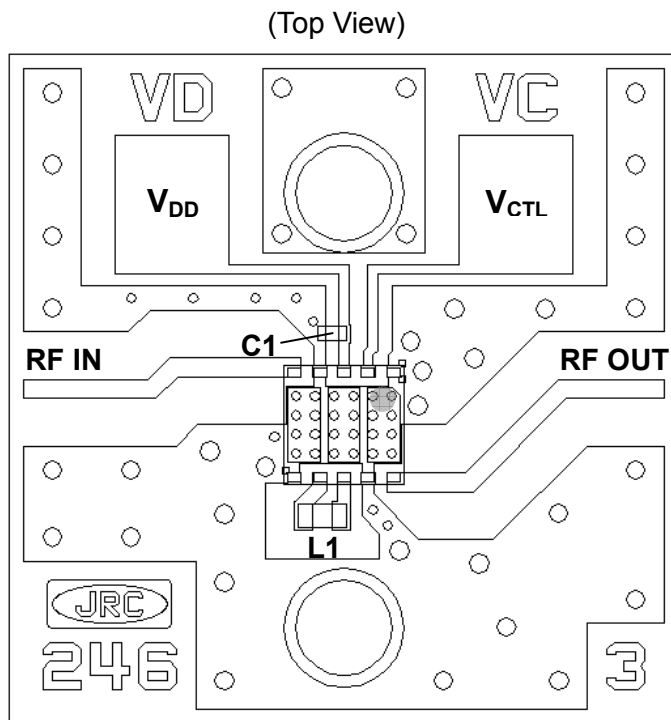

■ Evaluation board

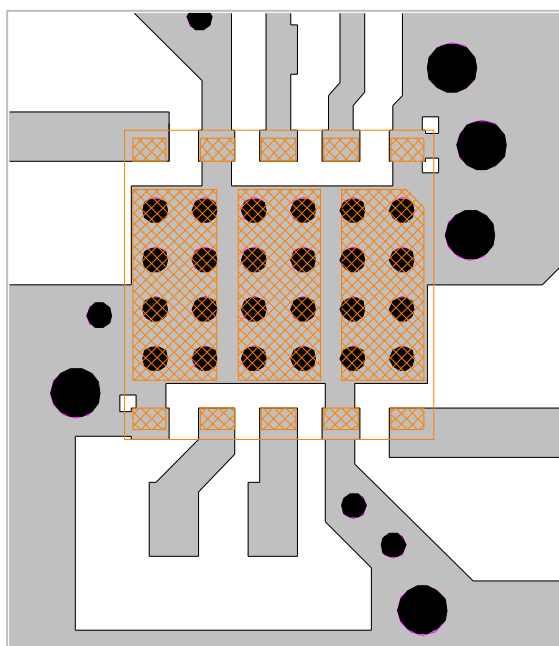

PCB
 Substrate: FR-4
 Thickness: 0.2mm
 Microstrip line width: 0.4mm ($Z_0=50\Omega$)
 Size: 14.0mm x 14.0mm

<PCB LAYOUT GUIDELINE>



-  PCB
-  PKG Terminal
-  PKG Outline
-  GND Via Hole
Diameter $\phi=0.2\text{mm}, 0.4\text{mm}$



PRECAUTIONS

- Please layout ground pattern under this FEM in order not to couple with RFIN and RFOUT terminal.
- All external parts should be placed as close as possible to the FEM.
- For good RF performance, all GND terminals must be connected to PCB ground plane of substrate, and via-holes for GND should be placed near the FEM.

NJG1156PCD

RECOMMENDED FOOTPRINT PATTERN (HFFP10-CD PACKAGE) <Reference>

PKG : 2.5mm x 2.5mm

-  : Land
-  :Mask (Open area) *Metal mask thickness : 100μm
-  :Resist(Open area)

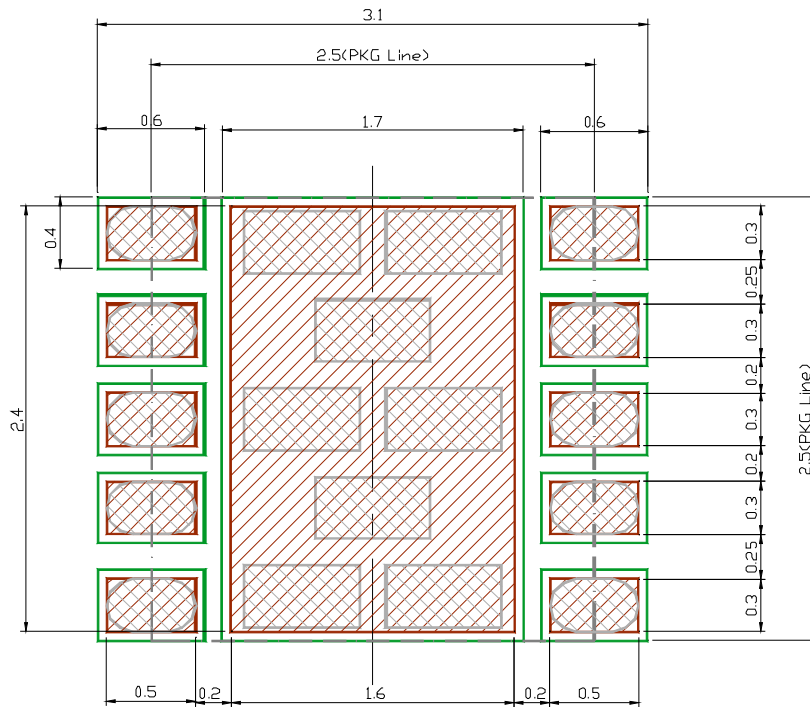

Metal MASK Detail

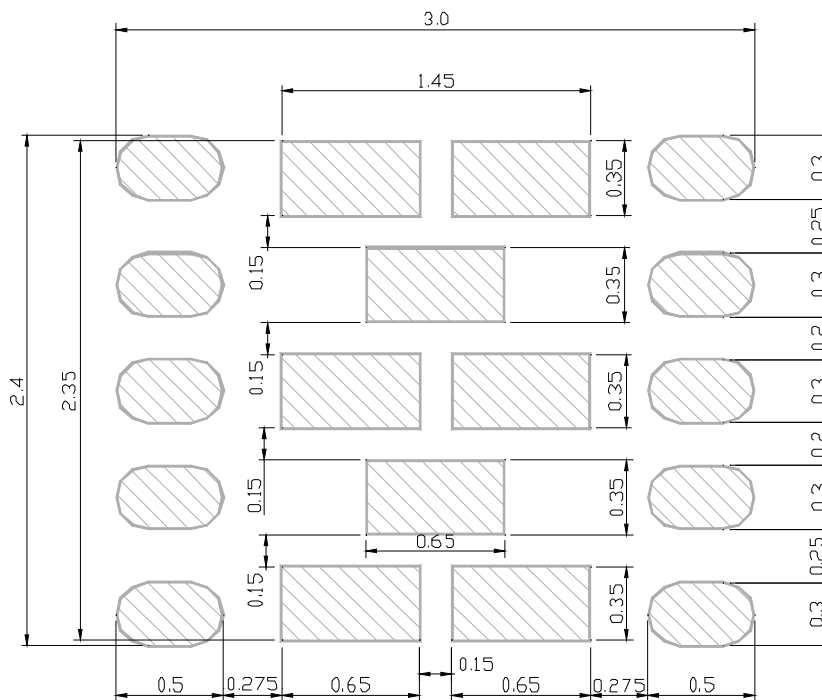

■ NOISE FIGURE MEASUREMENT BLOCK DIAGRAM

Measuring instruments

NF Analyzer : Agilent N8973A
 Noise Source : Agilent 346A

Setting the NF analyzer

Measurement mode form

Device under test : Amplifier
 System downconverter : off

Mode setup form

Sideband : LSB
 Averages : 16
 Average mode : Point
 Bandwidth : 4MHz
 Loss comp : off
 Tcold : setting the temperature of noise source (303.15K)

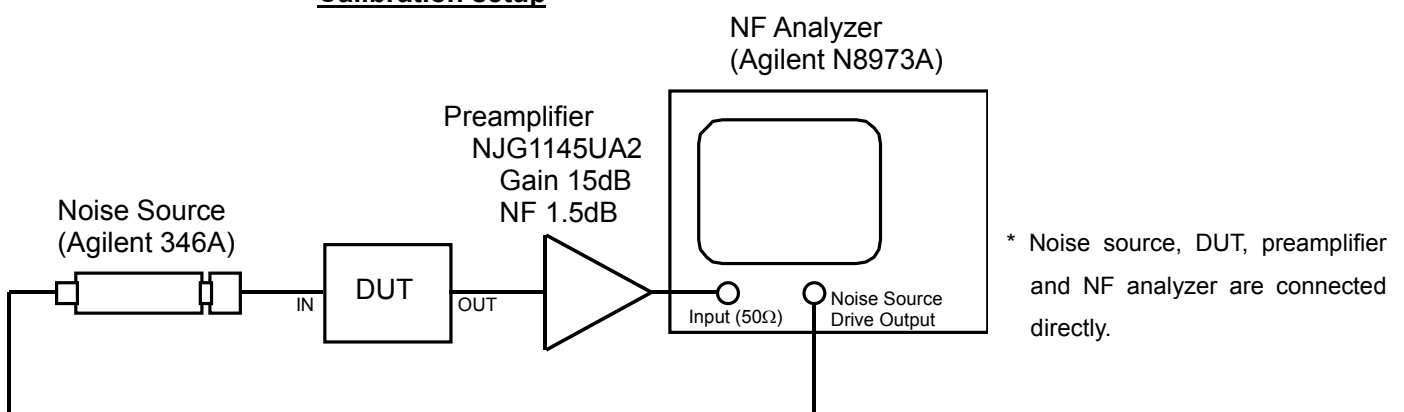
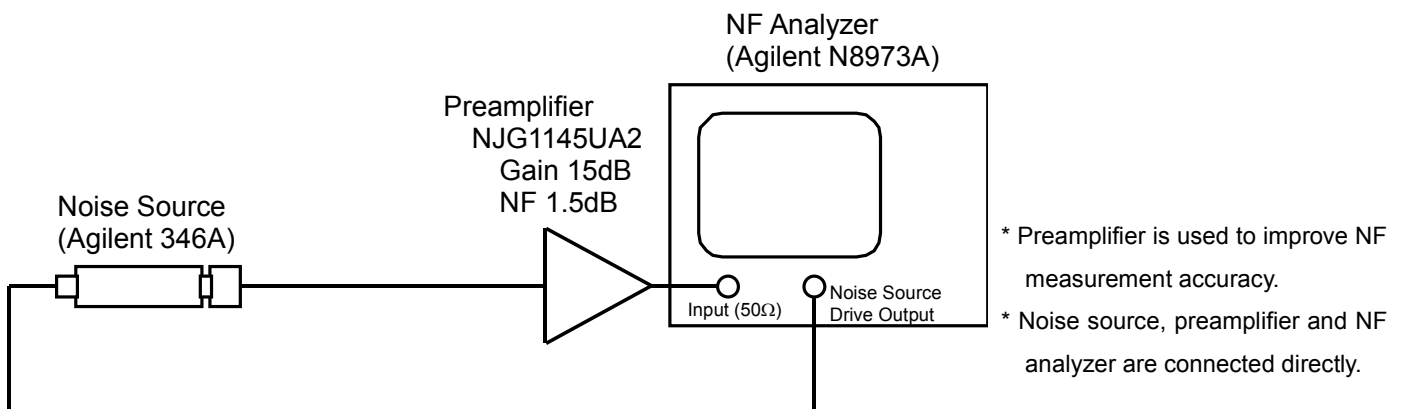

NJG1156PCD

PACKAGE OUTLINE (HFFP10-CD)

TOP VIEW

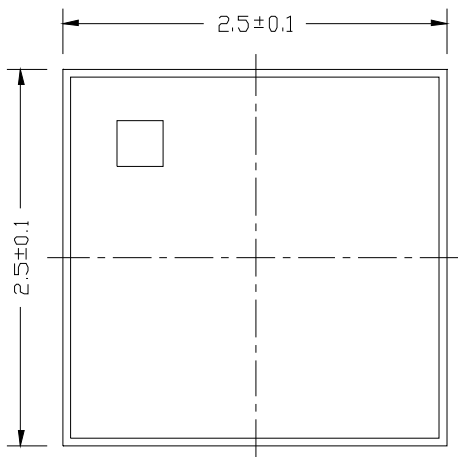

SIDE VIEW

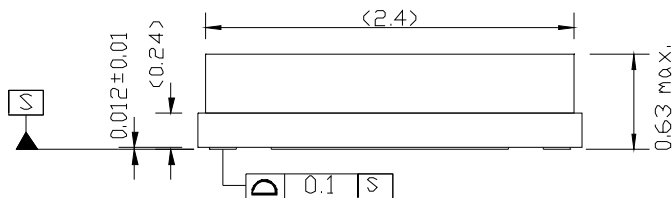

BOTTOM VIEW

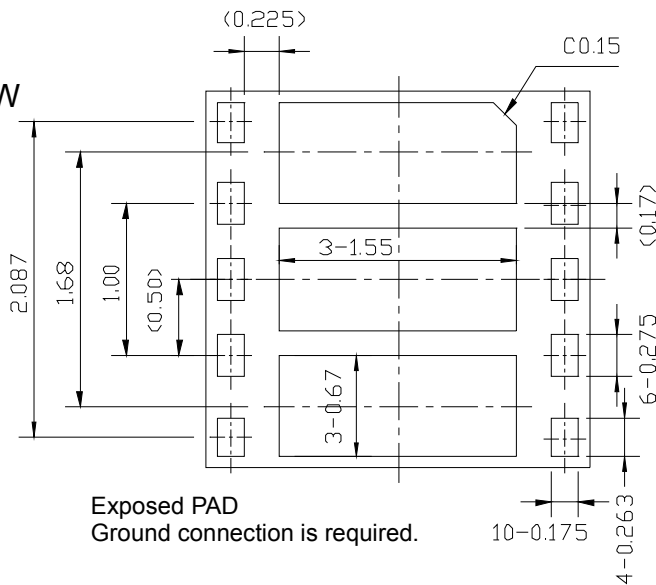

Package Size : 2.5 ± 0.1 mm
0.63 mm max.
Electrode Dimensions clearance : ± 0.05 mm

Unit : mm
Substrate : Ceramic
Terminal treat : Au
Lid : SnAg/Kovar/Ni
Weight (typ.) : 18.00 mg

Cautions on using this product

This product contains Gallium-Arsenide (GaAs) which is a harmful material.

- Do NOT eat or put into mouth.
- Do NOT dispose in fire or break up this product.
- Do NOT chemically make gas or powder with this product.
- To waste this product, please obey the relating law of your country.

[CAUTION]

The specifications on this databook are only given for information, without any guarantee as regards either mistakes or omissions. The application circuits in this databook are described only to show representative usages of the product and not intended for the guarantee or permission of any right including the industrial rights.

This product may be damaged with electric static discharge (ESD) or spike voltage. Please handle with care to avoid these damages.

This product is hollow seal package type, and it is with the structure susceptible to stress from the outside. Therefore, note the following in relation to the contents, after conducting an evaluation, please use.

1. After mounting this product, to implement the potting and transfer molding, please the confirmation of resistance to temperature changes and shrinkage stress involved in the molding.
2. When mounted on the product, collet diameter please use more than 1 mmφ. In addition, the value of static load is recommended mounting less than 5N.
3. For dynamic load at the time of mounting, please use it after confirming in consideration of the contact area / speed / load.

X-ON Electronics

Largest Supplier of Electrical and Electronic Components

Click to view similar products for [RF Front End](#) category:

Click to view products by [Nisshinbo](#) manufacturer:

Other Similar products are found below :

[SE2622L-R](#) [BGM1032N7E6327XUSA1](#) [LX5586LL](#) [LX5586HLL](#) [LX5586ALL](#) [SKY66111-21](#) [SKY65728-11](#) [SKY68000-31](#) [SKY85308-11](#)
[SKY85302-11](#) [SKY85300-21](#) [ADTR1107ACCZ](#) [LMP91051MTX/NOPB](#) [SE5501L-R](#) [QPF4519SR](#) [SE5503A-R](#) [ADA8282WBCPZ](#)
[ADRF5545ABCPZN](#) [ADRF5545ABCPZN-R7](#) [AD8283WBCPZ](#) [AD8284WCSVZ](#) [ADRF5547BCPZN](#) [ADRF5547BCPZN-R7](#)
[ADRF5549BCPZN](#) [ADRF5549BCPZN-R7](#) [HV7350K6-G](#) [SE5516A-R](#) [MCP2030-I/SL](#) [MAX2009ETI+](#) [MAX2078CTK+](#) [MAX2335ETI+](#)
[MAX2678GTB/V+T](#) [MD2131K7-G](#) [MD2134K7-G](#) [RFFM4554SR](#) [RFFM4554TR7](#) [RFFM8504SR](#) [RFFM8511SR](#) [RFFM4552TR7](#)
[RFFM4503TR7](#) [RFFM6903TR13](#) [HV7351K6-G](#) [MCP2035-I/ST](#) [SE2614BT-R](#) [SE2438T-R](#) [SST12LF02-QXCE](#) [SST12LF09-Q3CE](#)
[RFX2401C](#) [RFX2402E](#) [SKY85201-11](#)