

Designated client product

This product will be discontinued its production in the near term.
And it is provided for customers currently in use only, with a time limit.
It can not be available for your new project. Please select other new or existing products.

For more information, please contact our sales office in your region.

New Japan Radio Co.,Ltd.

www.njr.com

LOW-NOISE DUAL PRE-AMPLIFIER

■ GENERAL DESCRIPTION

The NJM2043 is a bipolar operational amplifier which is designed as low noise version of the NJM4558 with high output current and fast slew rate (6V/μs) and wide unity gain bandwidth (14MHz) constructed using New JRC Planar epitaxial process.

■ FEATURES

- Operating Voltage (±4V~±22V)
- High Output Current (25mA.)
- Slew Rate (6V/μs typ.)
- Unity Gain Bandwidth (14MHz typ.)
- Package Outline DIP8,DMP8,SIP8
- Bipolar Technology

■ PACKAGE OUTLINE

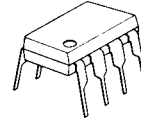

NJM2043D



NJM2043M

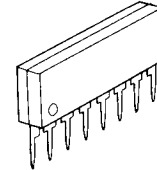

NJM2043L

■ PIN CONFIGURATION

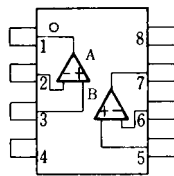

NJM2043D
NJM2043M

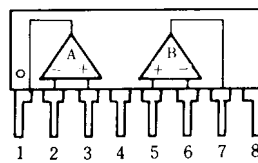

NJM2043L

PIN FUNCTION

- 1.A OUTPUT
- 2.A -INPUT
- 3.A +INPUT
- 4.V-
- 5.B +INPUT
- 6.B -INPUT
- 7.B OUTPUT
- 8.V+

■ EQUIVALENT CIRCUIT (1/2 Shown)

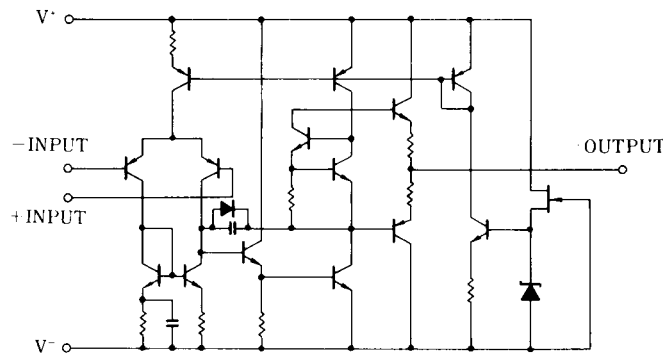

NJM2043

■ ABSOLUTE MAXIMUM RATINGS

(Ta=25°C)

| PARAMETER | SYMBOL | RATINGS | UNIT |
|-----------------------------|-------------|--|------|
| Supply Voltage | V^+ / V^- | ± 22 | V |
| Differential Input Voltage | V_{ID} | ± 30 | V |
| Input Voltage | V_{IC} | ± 15 (note) | V |
| Power Dissipation | P_D | (DIP8) 500 (DMP8) 300 (SIP8) 800 | mW |
| Operating Temperature Range | T_{opr} | -20~+75 | °C |
| Storage Temperature Range | T_{stg} | -40~+125 | °C |

(note) For supply voltage less than ±15V, the absolute maximum input voltage is equal to the supply voltage.

■ ELECTRICAL CHARACTERISTICS

(Ta=25°C, $V^+ / V^- = \pm 15V$)

| PARAMETER | SYMBOL | TEST CONDITION | MIN. | TYP. | MAX. | UNIT |
|---------------------------------|-----------|------------------------------------|------|--------|------|-------|
| Input Offset Voltage | V_{IO} | $R_S \leq 10k\Omega$ | - | 0.3 | 3 | mV |
| Input Offset Current | I_{IO} | | - | 10 | 200 | nA |
| Input Bias Current | I_B | | - | 400 | 1000 | nA |
| Input Resistance | R_{IN} | | 30 | 100 | - | kΩ |
| Large signal Voltage Gain | A_V | $R_L \geq 2k\Omega, V_O = \pm 10V$ | 86 | 100 | - | dB |
| Maximum Output Voltage Swing 1 | V_{OM1} | $R_L \geq 10k\Omega$ | ± 12 | ± 14 | - | V |
| Maximum Output Voltage Swing 2 | V_{OM2} | $I_O = 25mA$ | ± 10 | ± 11.5 | - | V |
| Input Common Mode Voltage Range | V_{ICM} | | ± 12 | ± 14 | - | V |
| Common Mode Rejection Ratio | CMR | $R_S \leq 10k\Omega$ | 70 | 100 | - | dB |
| Supply Voltage Rejection Ratio | SVR | $R_S \leq 10k\Omega$ | 76 | 100 | - | dB |
| Operating Current | I_{CC} | | - | 6 | 8 | mA |
| Slew Rate | SR | | - | 6 | - | V/μs |
| Gain Bandwidth Product | GB | | - | 14 | - | MHz |
| Equivalent Input Noise Voltage | V_{NI} | FLAT+JISA $R_S = 300\Omega$ | - | 0.4 | 0.51 | μVrms |

(note1) Closed loop gain should be more than 20dB at use.

(note2) New JRC's general selected products D rank are also prepared for the noise standard ($R_S = 2.2k\Omega, R_{IAA}, V_{NI} = 1.4\mu V$ Max.)

■ TYPICAL CHARACTERISTICS

Open Loop Voltage Gain vs. Frequency

($V^+/V^- = \pm 15V$, $R_L = 2k\Omega$, $T_a = 25^\circ C$)

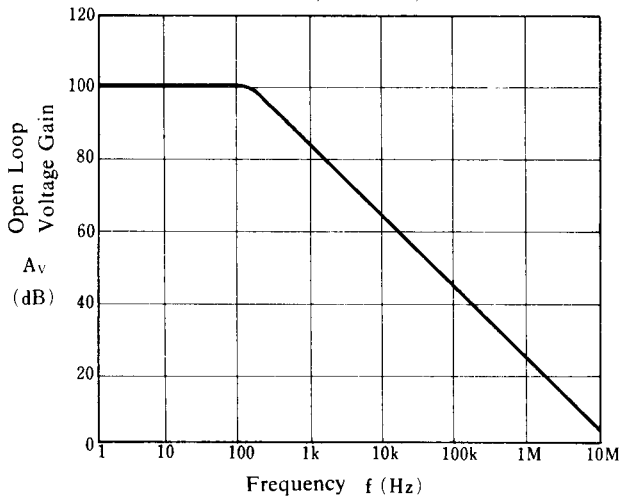

Equivalent Input Noise Voltage

($V^+/V^- = \pm 15V$, $T_a = 25^\circ C$)

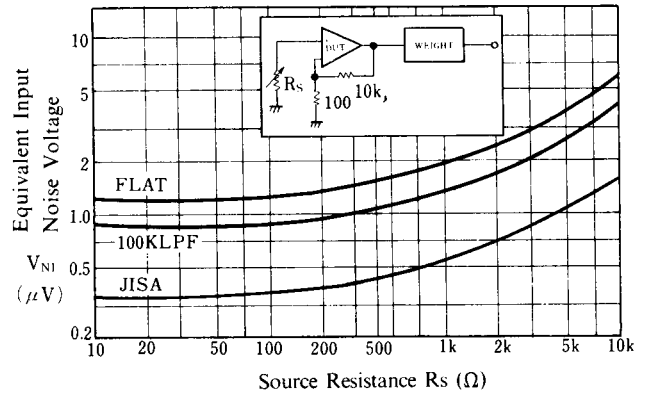

Maximum Output Voltage Swing vs. Load Resistance

($V^+/V^- = \pm 15V$, $T_a = 25^\circ C$)

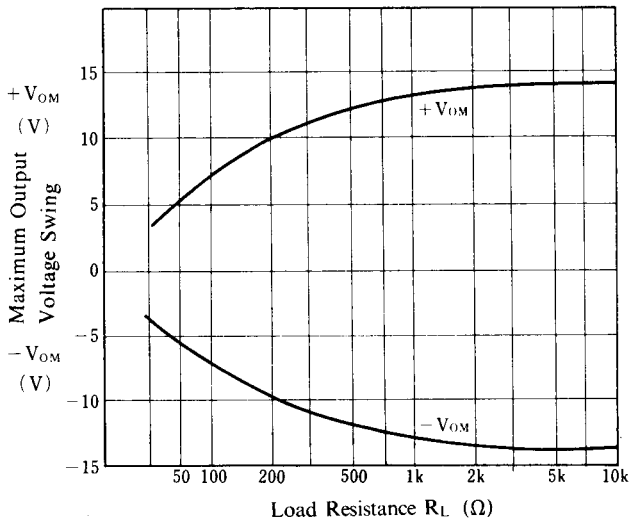

Maximum Output Voltage Swing vs. Output Current

($V^+/V^- = 15V$, $T_a = 25^\circ C$)

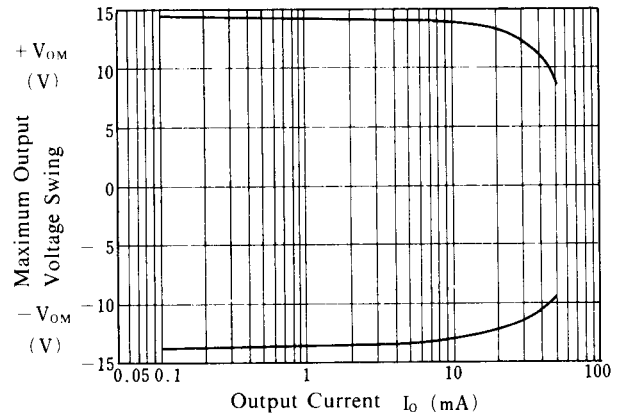

Operating Current vs. Temperature

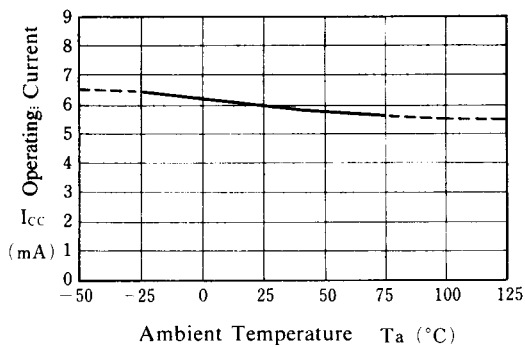

Maximum Output Voltage Swing vs. Temperature

($V^+/V^- = 15V$, $R_L = 10k\Omega$)

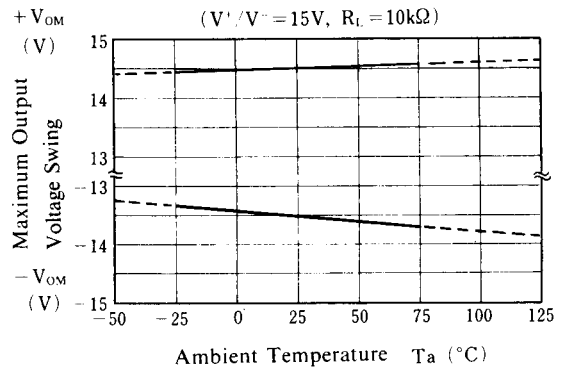

■ TYPICAL CHARACTERISTICS

Input Offset Voltage vs. Temperature

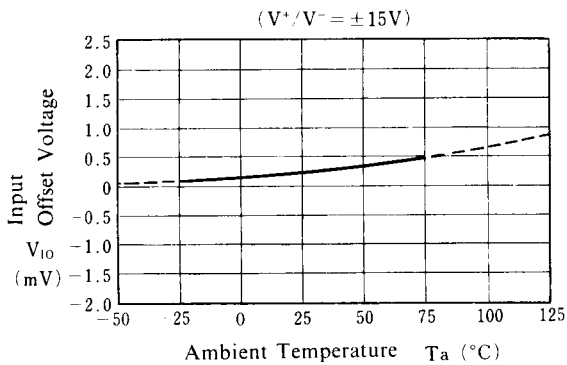

Input Bias Current vs. Temperature

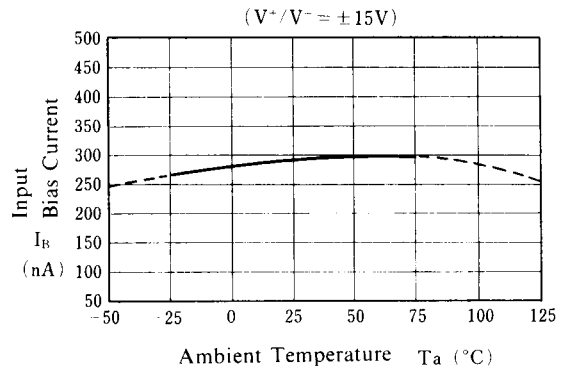

Maximum Output Voltage Swing vs. Operating Voltage

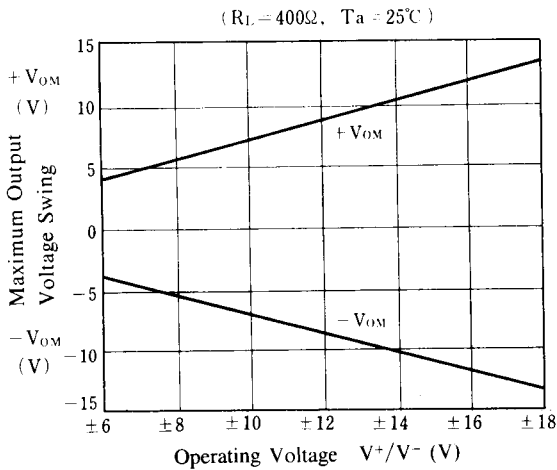

Maximum Output Voltage Swing vs. Supply Voltage

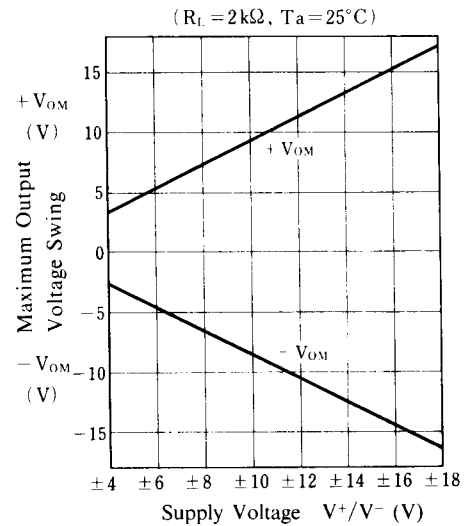

Operating Current vs. Operating Voltage

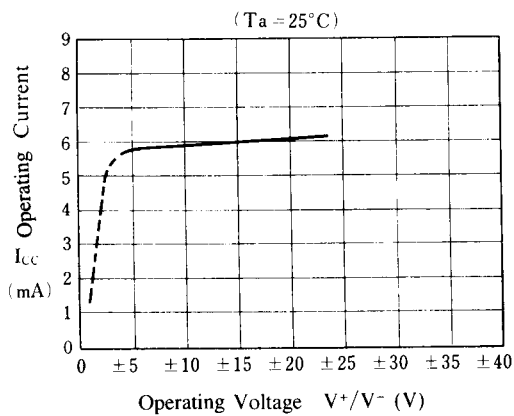

Maximum Output Voltage Swing vs. Frequency

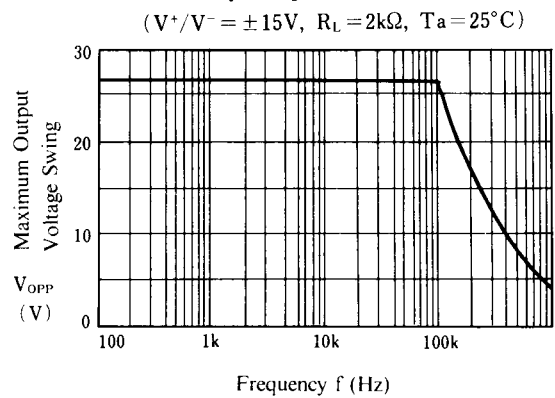

[CAUTION]

The specifications on this databook are only given for information, without any guarantee as regards either mistakes or omissions. The application circuits in this databook are described only to show representative usages of the product and not intended for the guarantee or permission of any right including the industrial rights.

X-ON Electronics

Largest Supplier of Electrical and Electronic Components

Click to view similar products for [Operational Amplifiers - Op Amps](#) category:

Click to view products by [Nisshinbo](#) manufacturer:

Other Similar products are found below :

[NCV33072ADR2G](#) [LM358SNG](#) [430227FB](#) [UPC824G2-A](#) [LT1678IS8](#) [042225DB](#) [058184EB](#) [UPC822G2-A](#) [UPC259G2-A](#) [UPC258G2-A](#)
[NTE925](#) [AZV358MTR-G1](#) [AP4310AUMTR-AG1](#) [HA1630D02MMEL-E](#) [HA1630S01LPEL-E](#) [SCY33178DR2G](#) [NJU77806F3-TE1](#)
[NCV5652MUTWG](#) [NCV20034DR2G](#) [LM324EDR2G](#) [LM2902EDR2G](#) [NTE7155](#) [NTE778S](#) [NTE871](#) [NTE924](#) [NTE937](#) [MCP6V17T-](#)
[E/MNY](#) [MCP6V19-E/ST](#) [MXD8011HF](#) [MCP6V17T-E/MS](#) [SCY6358ADR2G](#) [ADA4523-1BCPZ](#) [LTC2065HUD#PBF](#) [ADA4523-1BCPZ-](#)
[RL7](#) [NJM2904CRB1-TE1](#) [2SD965T-R](#) [RS6332PXK](#) [BDM8551](#) [BDM321](#) [MD1324](#) [COS8052SR](#) [COS8552SR](#) [COS8554SR](#) [COS2177SR](#)
[COS2353SR](#) [COS724TR](#) [ASOPD4580S-R](#) [RS321BKXF](#) [ADA4097-1HUIJZ-RL7](#) [NCS20282FCTTAG](#)