

ADJUSTABLE LOW DROPOUT VOLTAGE REGULATOR WITH ON/OFF CONTROL

GENERAL DESCRIPTION

The NJM2387A is an adjustable low dropout voltage regulator. The output current is up to 1.0A and dropout voltage is 0.2V typ. at $I_o=0.5A$. OFF control quiescent current is drastically reduced compare with the current NJM2387 through changing ON/OFF control circuit. The NJM2387A is suitable for power module, TV, Display, car stereo and low power applications.

PACKAGE OUTLINE

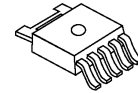

NJM2387ADL3

FEATURES

- Low Dropout Voltage $\Delta V_{I-O}=0.2V$ typ. at $I_o=0.5A$
- Output Current $I_o(\text{max.})=1.0A$
- Reference Voltage $V_{ref}=1.26V \pm 2\%$
- ON/OFF Control
- OFF Control Quiescent Current $1\mu A$ max.
- Internal Short Circuit Current Limit
- Internal Overvoltage Protection
- Internal Thermal Overload Protection
- Bipolar Technology
- Package Outline TO-252-5

PIN CONFIGURATION

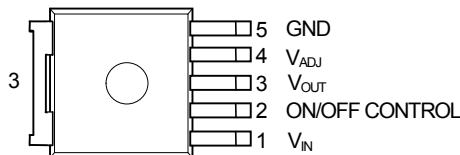

NJM2387ADL3

BLOCK DIAGRAM

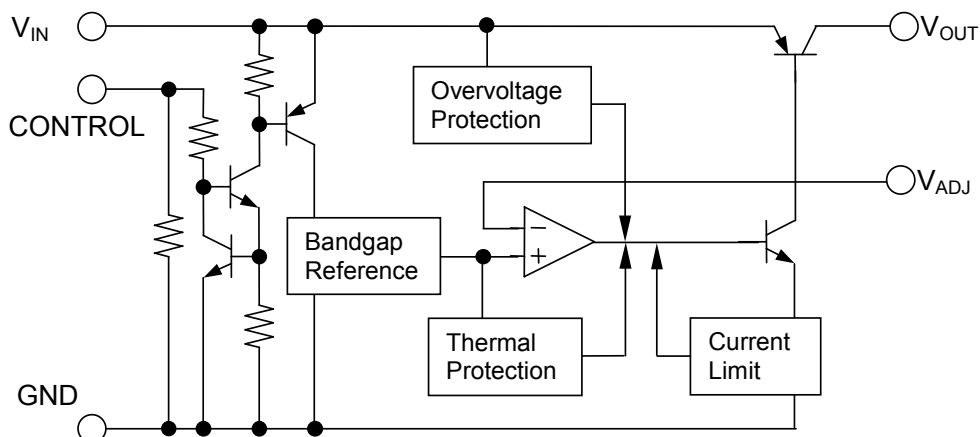

NJM2387A

■ ABSOLUTE MAXIMUM RATINGS

(Ta=25°C)

| PARAMETER | SYMBOL | RATINGS | UNIT |
|--------------------------------------|------------|------------|------|
| Input Voltage | V_{IN} | +35 | V |
| Control Voltage | V_{CONT} | +35(*1) | V |
| Adjust Terminal Voltage | V_{ADJ} | +6 | V |
| Power Dissipation | P_D | 1190(*2) | mW |
| | | 3125(*3) | |
| Operating Junction Temperature Range | T_j | -40 ~ +150 | °C |
| Operating Temperature Range | T_{opr} | -40 ~ +85 | °C |
| Storage Temperature Range | T_{stg} | -50 ~ +150 | °C |

(*1): When input voltage is less than +35V, the absolute maximum control voltage is equal to the input voltage.

(*2): Mounted on glass epoxy board. (76.2 × 114.3 × 1.6mm:based on EIA/JEDEC standard size, 2Layers, Cu area 100mm²)

(*3): Mounted on glass epoxy board. (76.2 × 114.3 × 1.6mm:based on EIA/JEDEC standard, 4Layers)

(For 4Layers: Applying 74.2 × 74.2mm inner Cu area and a thermal via hole to a board based on JEDEC standard JESD51-5)

■ ELECTRICAL CHARACTERISTICS ($V_{IN}=15V$, $V_O=10V$, $I_O=0.5A$, $R_1=1k\Omega$, $C_{IN}=0.33\mu F$, $C_O=22\mu F$, $T_j=25^\circ C$)

Measurement is conducted by pulse testing.

| PARAMETER | SYMBOL | CONDITIONS | MIN. | TYP. | MAX. | UNIT |
|---|----------------------------|--|---------|--------|-------|------|
| Input Voltage | V_{IN} | | 3.8 | - | 30 | V |
| Output Voltage | $V_{O(ADJ)}$ | | 1.5 | - | 20 | V |
| Reference Voltage | V_{ref} | | 1.235 | 1.26 | 1.285 | V |
| Line Regulation | $\Delta V_O/\Delta V_{IN}$ | $V_{IN}=V_O+1V \sim V_O+17V$ | - | 0.04 | 0.16 | %/V |
| Load Regulation | $\Delta V_O/\Delta I_O$ | $V_{IN}=V_O+2V, I_O=0A \sim 1.0A$ | - | 0.2 | 1.4 | %/A |
| Average Temperature Coefficient of Output Voltage | $\Delta V_O/\Delta T$ | $T_j=0 \sim +125^\circ C$ | - | ± 0.02 | - | %/°C |
| Quiescent Current | I_Q | $I_O=0A, V_{CONT}=2.7V$ Except I_{CONT} | - | - | 5 | mA |
| OFF Control Quiescent Current | $I_{Q(OFF)}$ | $V_{CONT}=0V$ | - | - | 1 | μA |
| Dropout Voltage | ΔV_{LO} | $I_O=0.5A$ | - | 0.2 | 0.5 | V |
| Ripple Rejection | RR | $V_{in}=V_O+2V, e_{in}=0.5V_{rms}$ $e_{in}=0.5V_{rms}, f=120Hz$ | 52 | 65 | - | dB |
| ON Control Voltage | $V_{CONT(ON)}$ | | 2.0(*4) | - | - | V |
| OFF Control Voltage | $V_{CONT(OFF)}$ | | - | - | 0.4 | V |
| ON Control Current | $I_{CONT(ON)}$ | $V_C=2.7V$ | 10 | 30 | 50 | μA |
| OFF Control Current | $I_{CONT(OFF)}$ | $V_C=0.4V$ | 1 | 3 | 5 | μA |

(*4): When ON/OFF CONTROL pin is open, Output Voltage is OFF.

■ THERMAL CHARACTERISTICS

| PARAMETER | SYMBOL | VALUE | UNIT |
|---|---------------|---------------------|----------------------|
| Junction-to-Ambient thermal resistance | θ_{ja} | 105 (*5) 40 (*6) | $^{\circ}\text{C/W}$ |
| Junction-to-Top of package characterization parameter | ψ_{jt} | 17 (*5) 12 (*6) | $^{\circ}\text{C/W}$ |

(*5): Mounted on glass epoxy board. (76.2 × 114.3 × 1.6mm:based on EIA/JEDEC standard size, 2Layers, Cu area 100mm²)

(*6): Mounted on glass epoxy board. (76.2 × 114.3 × 1.6mm:based on EIA/JEDEC standard, 4Layers)

(For 4Layers: Applying 74.2 × 74.2mm inner Cu area and a thermal via hole to a board based on JEDEC standard JESD51-5)

■ POWER DISSIPATION vs. AMBIENT TEMPERATURE

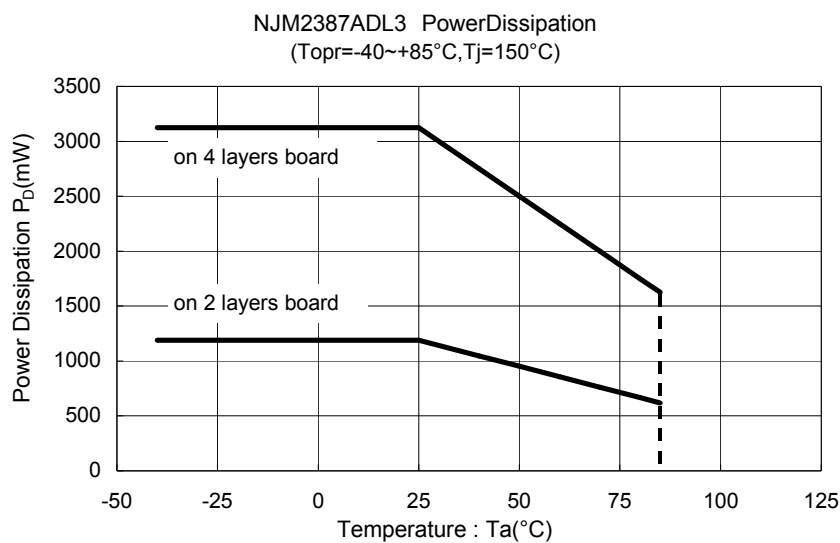

■ TEST CIRCUIT

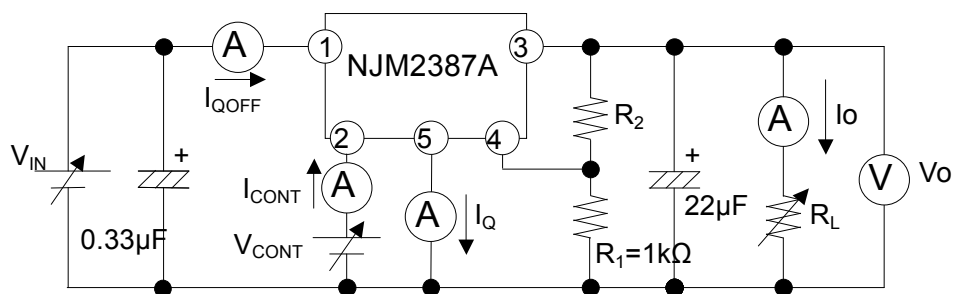

$$V_o = V_{ref} \times (1 + R_2/R_1)$$

NJM2387A

■ TYPICAL APPLICATION

① In the case where ON/OFF Control is not required:

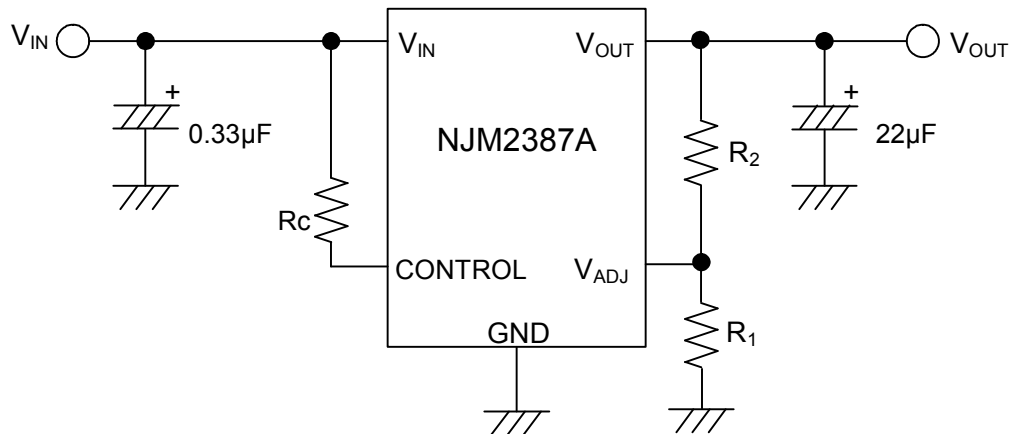

Connect control pin to V_{IN} pin.

② In use of ON/OFF CONTROL:

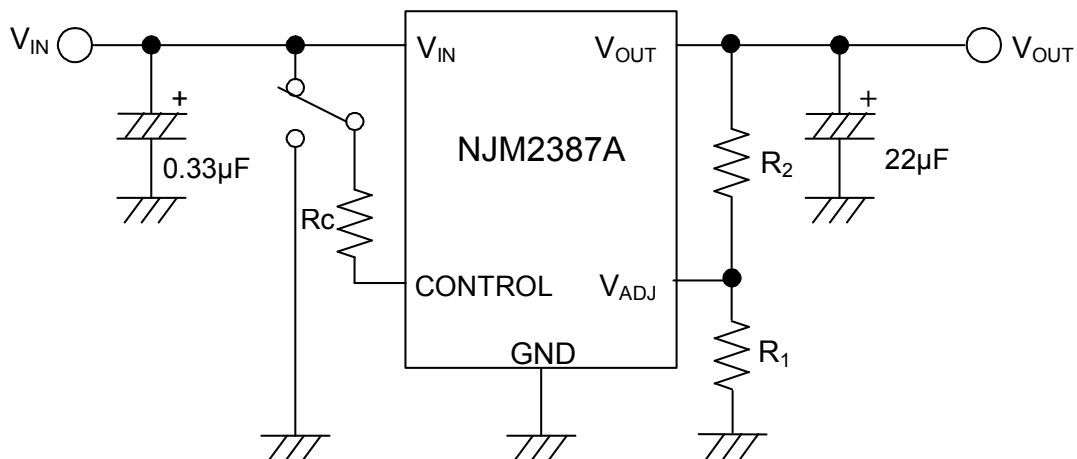

State of control pin:

- “H” → output is enabled.
- “L” or “open” → output is disabled.

*Feed back Resistance R1

The output voltage may rise against the set point by the leak current from the V_{OUT} pin at high temperature when this resistance is set too big.

Conversely, the current flowing to R1 grows big when R1 is set too small, and make the consumption current increase.

From the above, recommend 100Ω to $20k\Omega$ as a set range of R1.

*In the case of using a resistance "Rc" between V_{IN} and control.

If this resistor is inserted, it can reduce the control current when the control voltage is high.

The applied voltage to control pin should set to consider voltage drop through the resistor "Rc" and the minimum control voltage for ON-state.

The $V_{CONT(ON)}$ and I_{CONT} have temperature dependence as shown in the "Control Current vs. Temperature" and "Control Voltage vs. Temperature" characteristics. Therefore, the resistance "Rc" should be selected to consider the temperature characteristics.

*Input Capacitor C_{IN}

Input Capacitor C_{IN} is required to prevent oscillation and reduce power supply ripple for applications when high power supply impedance or a long power supply line.

Therefore, use the recommended C_{IN} value (refer to conditions of ELECTRIC CHARACTERISTIC) or larger and should connect between GND and V_{IN} as shortest path as possible to avoid the problem.

*Output Capacitor C_O

Output capacitor (C_O) will be required for a phase compensation of the internal error amplifier.

The capacitance and the equivalent series resistance (ESR) influence to stable operation of the regulator.

Use of a smaller C_O may cause excess output noise or oscillation of the regulator due to lack of the phase compensation.

On the other hand, Use of a larger C_O reduces output noise and ripple output, and also improves output transient response when rapid load change.

Therefore, use the recommended C_O value (refer to conditions of ELECTRIC CHARACTERISTIC) or larger and should connect between GND and V_{OUT} as shortest path as possible for stable operation

In addition, Please choose an appropriate capacitor in considering varied characteristics of capacitor (a frequency characteristic, a temperature characteristic, and so on) when selecting C_O .

NJM2387A

■ TYPICAL CHARACTERISTICS

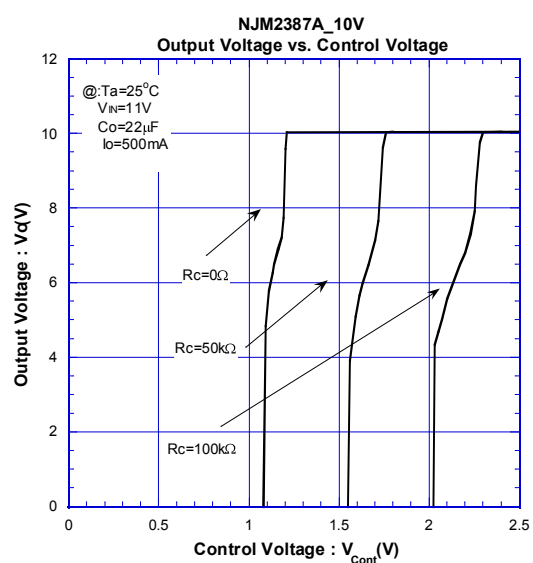
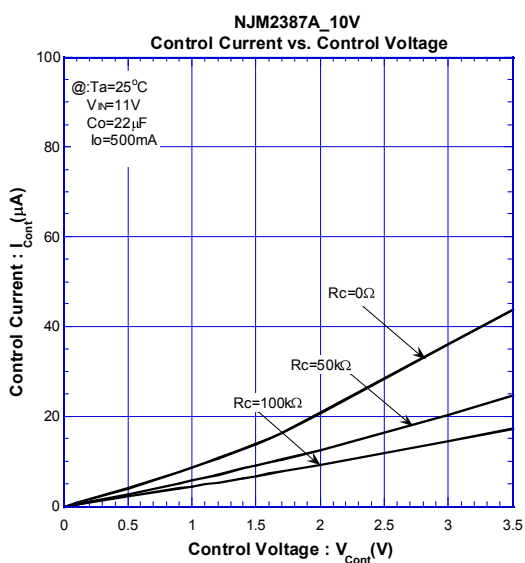
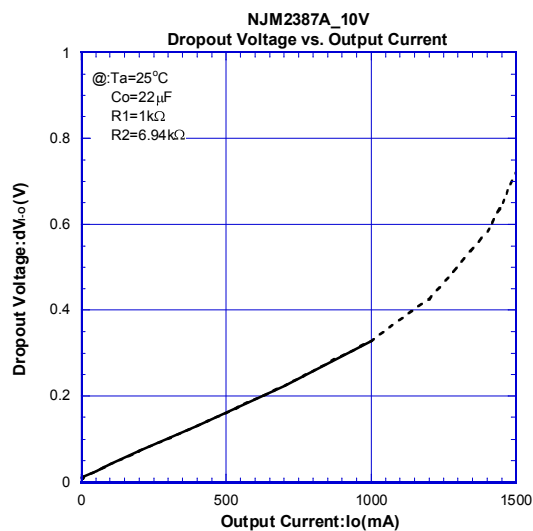
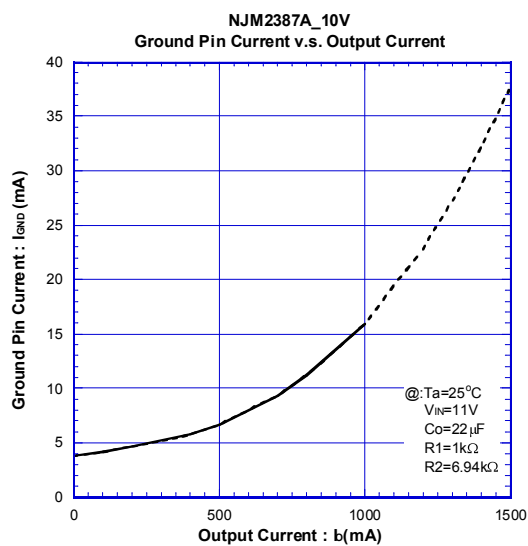
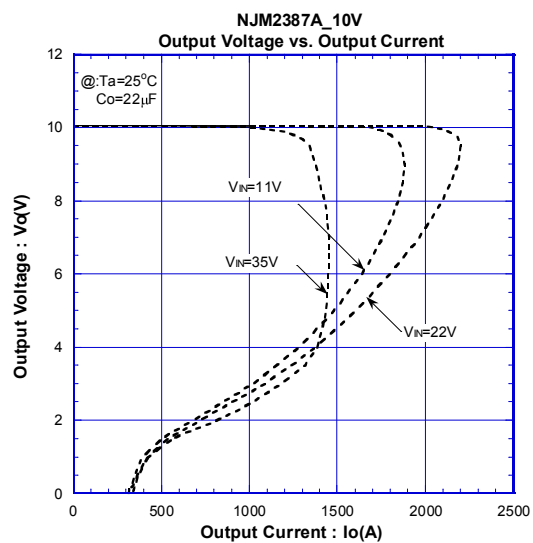
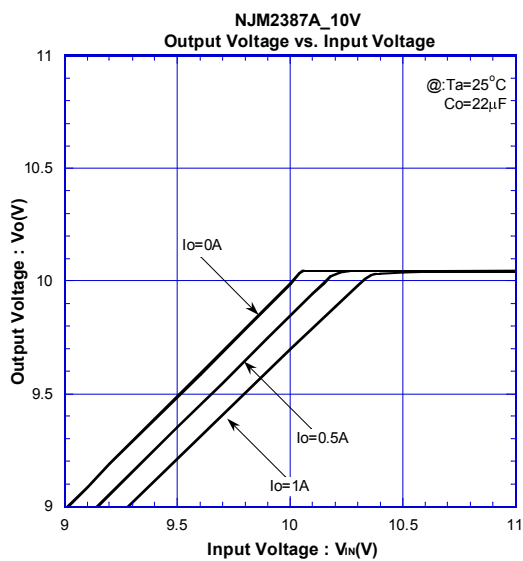

■ TYPICAL CHARACTERISTICS

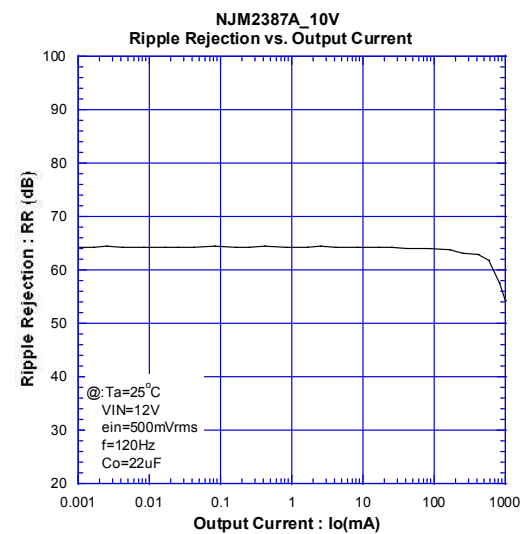
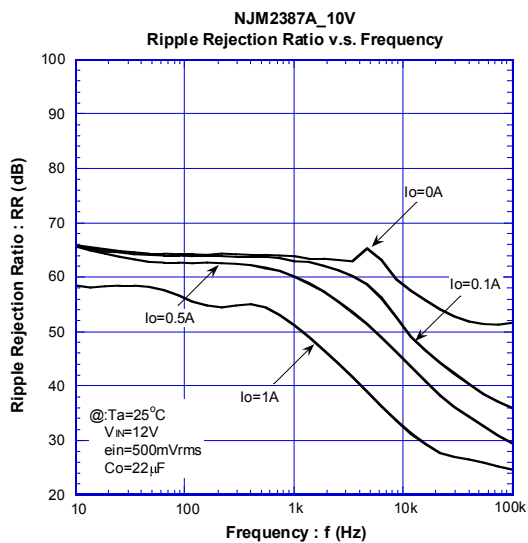
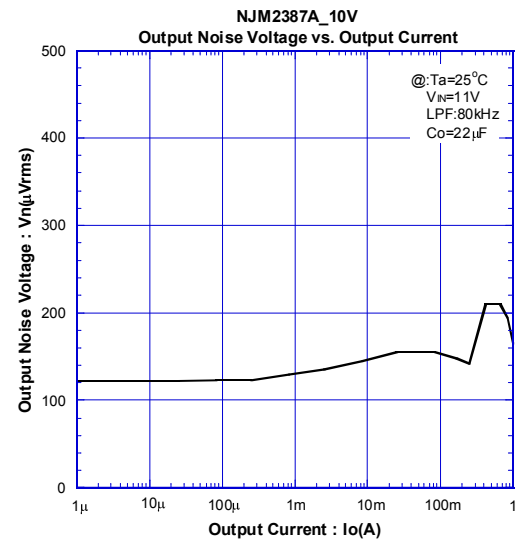
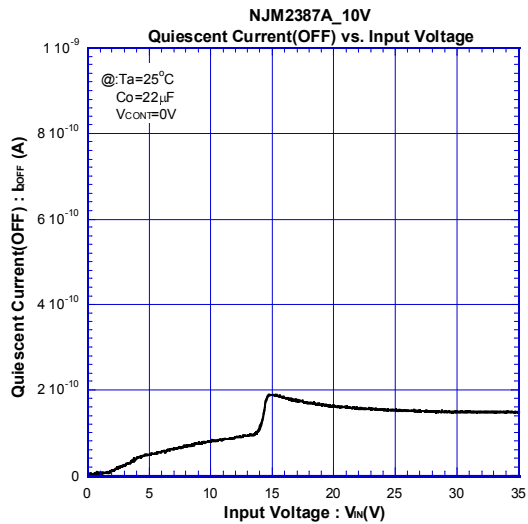
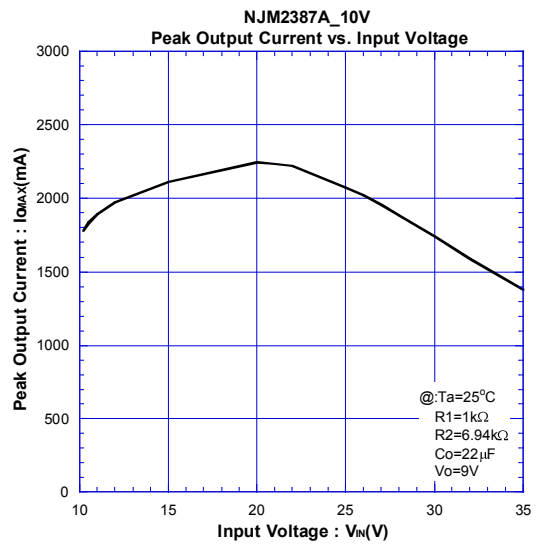
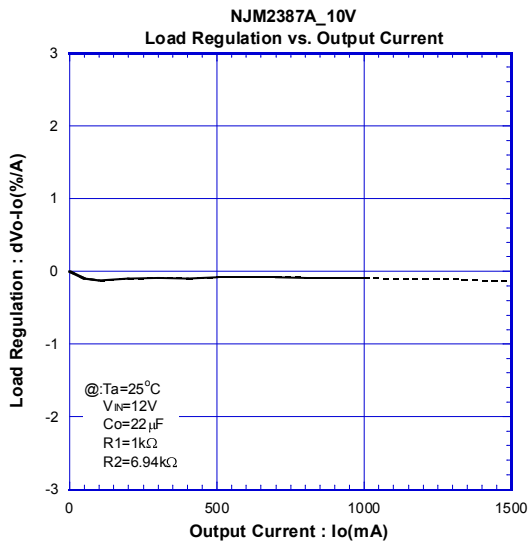

NJM2387A

■ TYPICAL CHARACTERISTICS

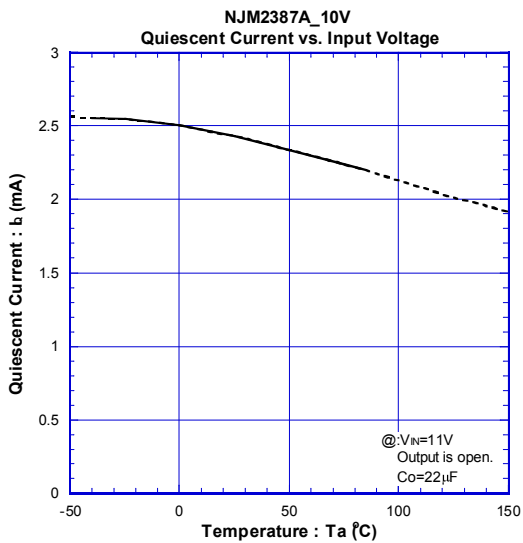
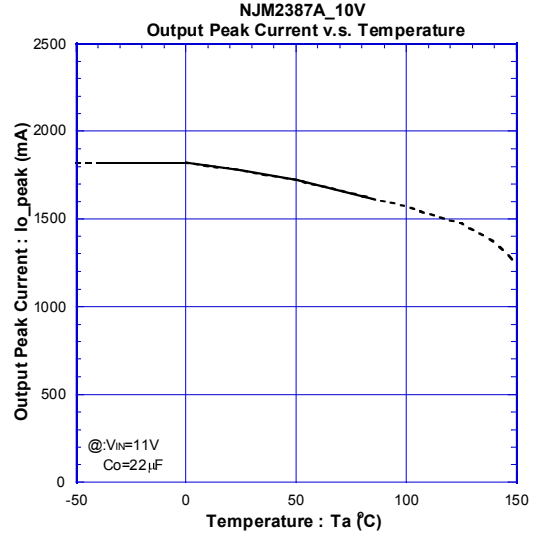
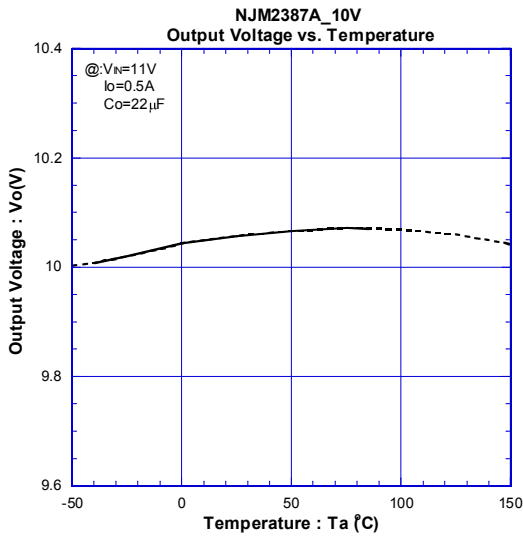
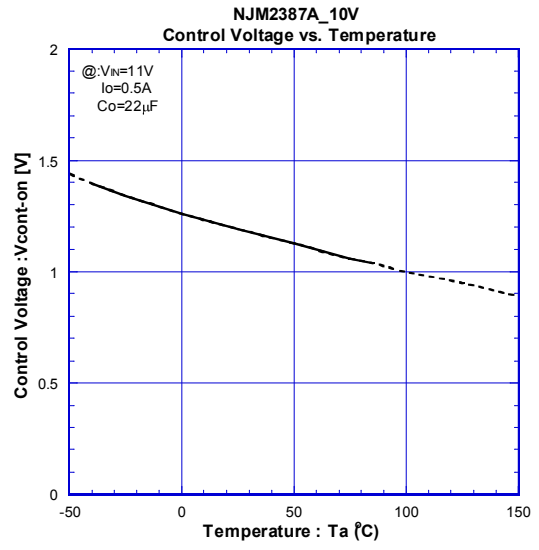
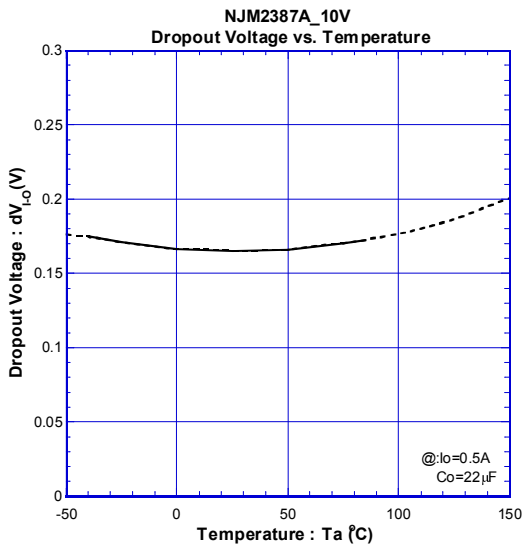

TYPICAL CHARACTERISTICS

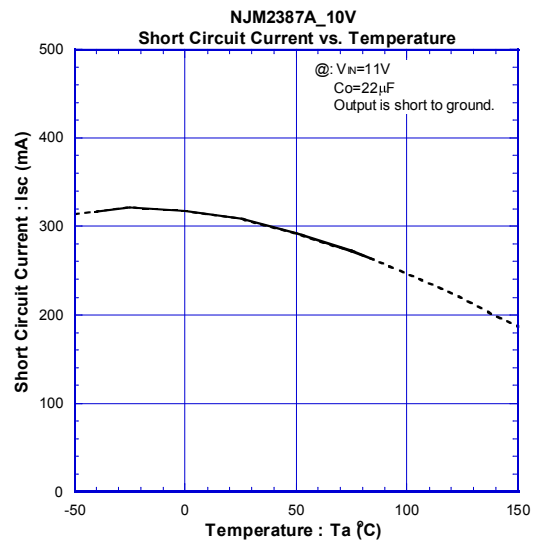
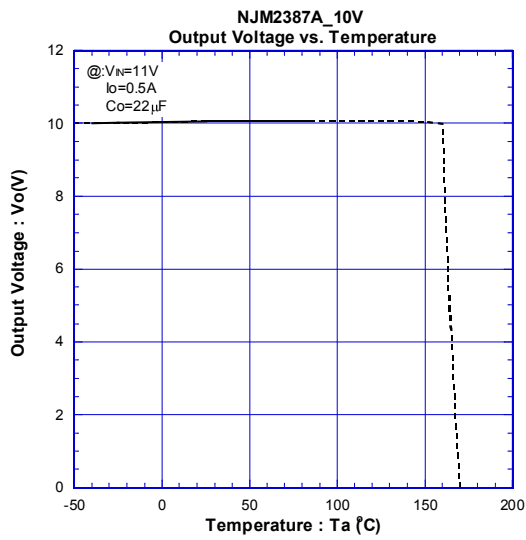
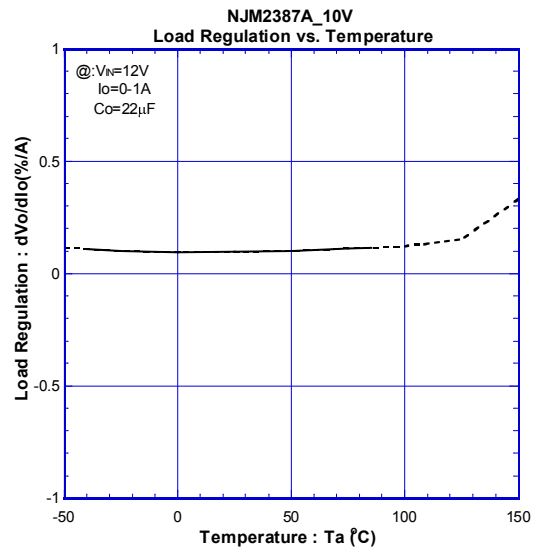
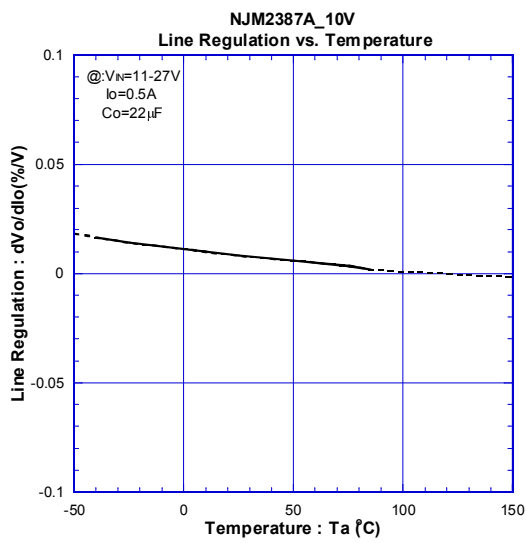

NJM2387A

TYPICAL CHARACTERISTICS

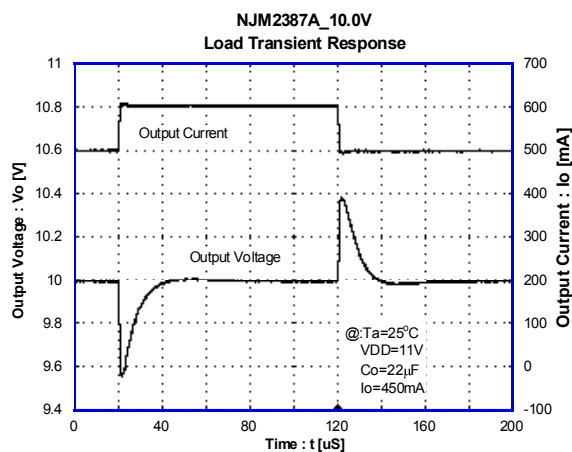
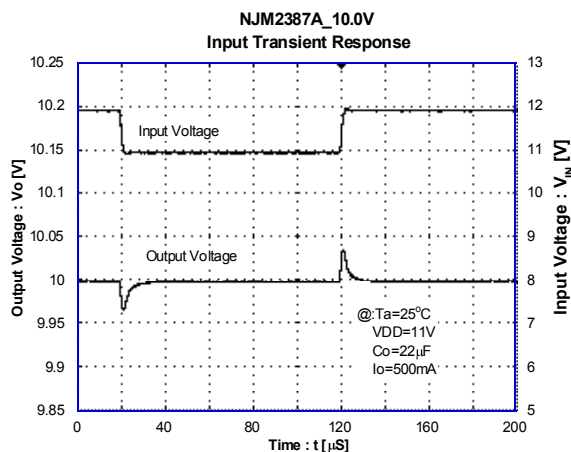
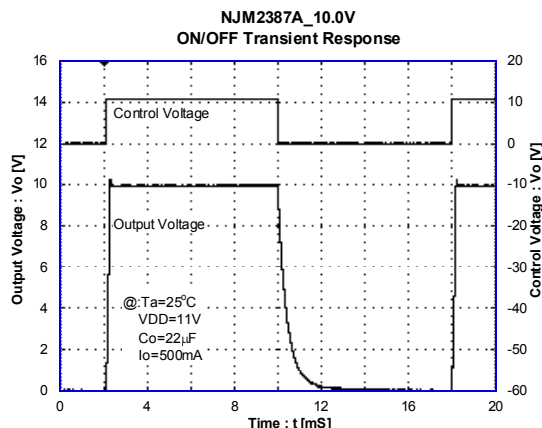
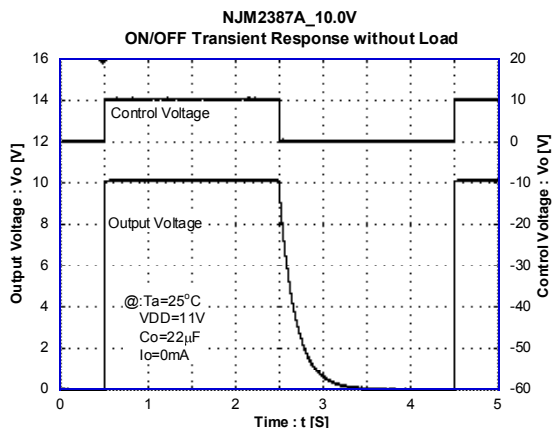

[CAUTION]
The specifications on this databook are only given for information, without any guarantee as regards either mistakes or omissions. The application circuits in this databook are described only to show representative usages of the product and not intended for the guarantee or permission of any right including the industrial rights.

X-ON Electronics

Largest Supplier of Electrical and Electronic Components

Click to view similar products for [LDO Voltage Regulators](#) category:

Click to view products by [Nisshinbo](#) manufacturer:

Other Similar products are found below :

[AP7363-SP-13](#) [NCV8664CST33T3G](#) [L79M05TL-E](#) [AP7362-HA-7](#) [PT7M8202B12TA5EX](#) [TCR3DF185,LM\(CT](#) [TLF4949EJ](#)
[NCP4687DH15T1G](#) [NCV8703MX30TCG](#) [LP2951CN](#) [NCV4269CPD50R2G](#) [AP7315-25W5-7](#) [NCV47411PAAJR2G](#) [AP2111H-1.2TRG1](#)
[ZLDO1117QK50TC](#) [AZ1117ID-ADJTRG1](#) [NCV4263-2CPD50R2G](#) [NCP706ABMX300TAG](#) [NCP114BMX075TCG](#) [MC33269T-3.5G](#)
[TLE4471GXT](#) [AP7315-33SA-7](#) [NCV4266-2CST33T3G](#) [NCP715SQ15T2G](#) [NCV8623MN-50R2G](#) [NCV563SQ18T1G](#) [NCV8664CDT33RKG](#)
[NCV4299CD250R2G](#) [NCP715MX30TBG](#) [NCV8702MX25TCG](#) [TLE7270-2E](#) [NCV562SQ25T1G](#) [AP2213D-3.3TRG1](#) [AP2202K-2.6TRE1](#)
[NCV8170BMX300TCG](#) [NCV8152MX300180TCG](#) [NCP700CMT45TBG](#) [AP7315-33W5-7](#) [NCP154MX180300TAG](#) [AP2113AMTR-G1](#)
[NJW4104U2-33A-TE1](#) [MP2013AGG-5-P](#) [NCV8775CDT50RKG](#) [NJM2878F3-45-TE1](#) [S-19214B00A-V5T2U7](#) [S-19214B50A-V5T2U7](#) [S-](#)
[19213B50A-V5T2U7](#) [S-19214BC0A-E8T1U7*1](#) [S-19213B00A-V5T2U7](#) [S-19213B33A-V5T2U7](#)