

LOW VOLTAGE 3ch VIDEO AMPLIFIER WITH LPF

■ GENERAL DESCRIPTION

The **NJM2573** is a Low Voltage 3ch Video Amplifier with LPF. Internal 75Ω driver is easy to connect TV monitor directly.

The **NJM2573** corresponds to a clamp and bias inputs, and selection of a clamp/ bias is possible for one circuit, and it corresponds to various video signals.

The **NJM2573** features low power and small package, and is suitable for low power design on downsizing of DVC.

■ PACKAGE OUTLINE



NJM2573SE4



NJM2573V

■ FEATURES

- Operating Voltage 2.8 to 5.5V
- Input type Vin1: CLAMP
Vin2: CLAMP/ BIAS
Vin3: BIAS
- Internal LPF
- Internal 6dB amplifier
- Internal 75Ω Driver Circuit (2-system drive)
- Internal Power Saving Circuit
- Bipolar Technology
- Package Outline PCSP16, SSOP14

■ BLOCK DIAGRAM

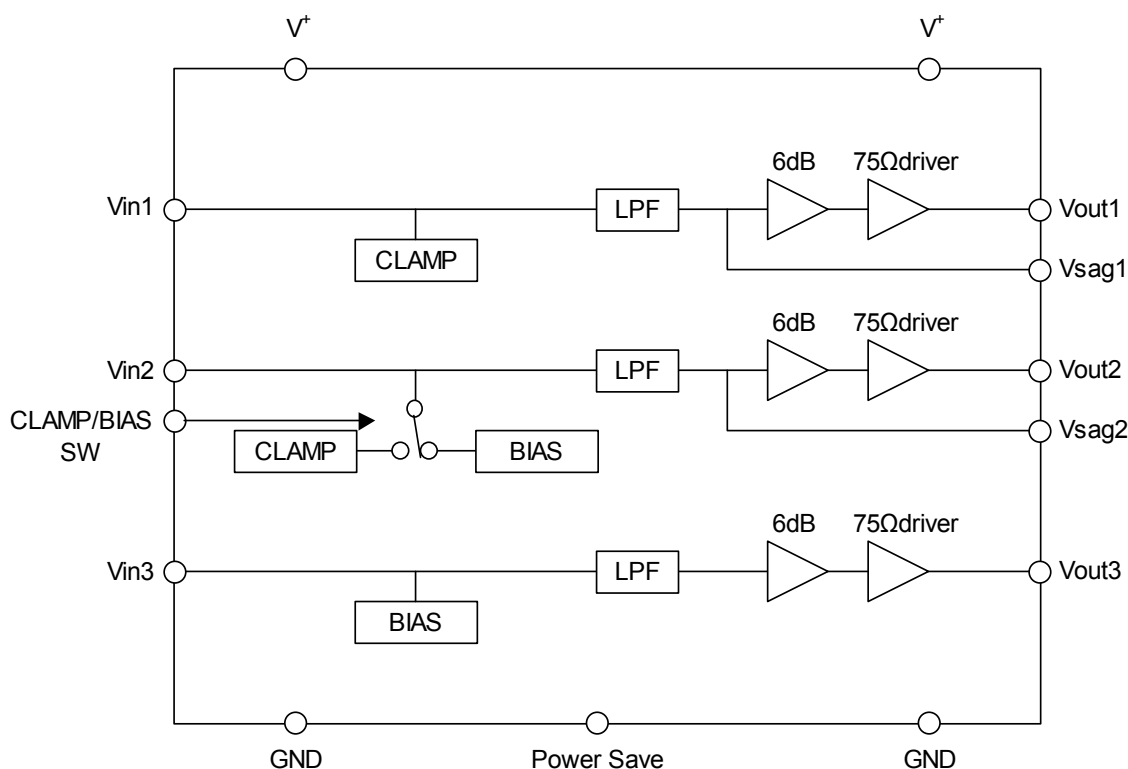

NJM2573

■PIN CONFIGURATION

PCSP16

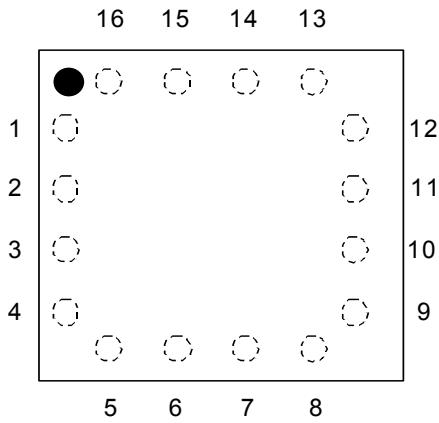

1. Vin1
2. Power Save
3. Vin2
4. NC
5. GND1
6. Vin3
7. CLAMP/BIAS SW
8. Vout3
9. GND2
10. Vout2
11. Vsag2
12. V⁺2
13. Vout1
14. Vsag1
15. NC
16. V⁺1

SSOP14

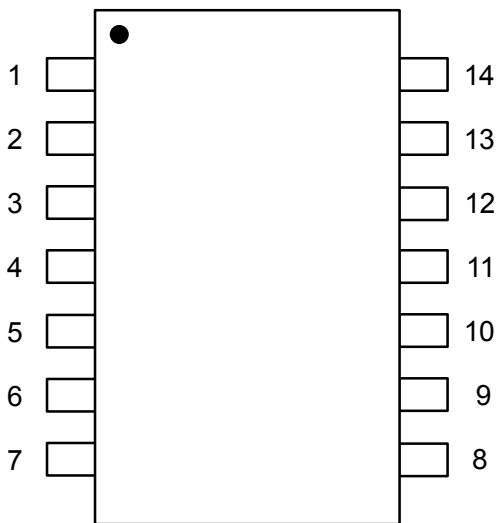

1. Vsag1
2. V⁺1
3. Vin1
4. Power Save
5. Vin2
6. GND1
7. Vin3
8. CLAMP/BIAS SW
9. Vout3
10. GND2
11. Vout2
12. Vsag2
13. V⁺2
14. Vout1

■ABSOLUTE MAXIMUM RATINGS (Ta=25°C)

PARAMETER	SYMBOL	RATINGS	UNIT
Supply Voltage	V ⁺	7.0	V
Power Dissipation	P _D	PCSP16 690 (Note) SSOP14 300	mW
Operating Temperature Range	Topr	-40 to +85	°C
Storage Temperature Range	Tstg	-40 to +125	°C

(Note) At on a board of EIA/JEDEC specification. (76.2×114.3×1.6mm, 4 layers, FR-4)

■ELECTRICAL CHARACTERISTICS (V⁺=3.0V, R_L=150Ω, Ta=25°C)

PARAMETER	SYMBOL	TEST CONDITION	MIN.	TYP.	MAX.	UNIT
Operating Voltage	Vopr		2.8	3.0	5.5	V
Operating Current	I _{CC}	No Signal	-	18.0	26.0	mA
Operating Current at Power Save	I _{save}	Power Save Mode	-	60	90	μA
Maximum Output Voltage Swing	Vomv	f=1kHz, THD=1%, CLAMP Input	2.2	2.4	-	Vp-p
	Vom RGB	f=1kHz, THD=1%, BIAS Input	1.4	2.2	-	
Voltage Gain	Gv	Vin=100kHz, 1.0Vp-p, Sin Signal (CLAMP) Vin=100kHz 0.7Vp-p, Sin Signal (BIAS)	6.0	6.4	6.8	dB
Low Pass Filter Characteristic	Gfy4.5M	Vin=4.5MHz/100kHz, 1.0Vp-p(CLAMP) Vin=4.5MHz/100kHz, 0.7Vp-p(BIAS)	-0.5	0.0	+0.5	dB
	Gfy8M	Vin=8MHz/100kHz, 1.0Vp-p(CLAMP) Vin=8MHz/100kHz, 0.7Vp-p(BIAS)	-	-2.0	-	
	Gfy16M	Vin=16MHz/100kHz, 1.0Vp-p(CLAMP) Vin=16MHz/100kHz, 0.7Vp-p(BIAS)	-	-12	-	
Cross talk	CT	Vin=4.43MHz, 1.0Vp-p, Sin Signal (CLAMP) Vin=4.43MHz 0.7Vp-p, Sin Signal (BIAS)	-	-65	-	dB
Differential Gain	DG	(CLAMP) Vin=1.0Vp-p Input 10step Video Signal	-	0.2	-	%
Differential Phase	DP	(CLAMP) Vin=1.0Vp-p Input 10step Video Signal	-	0.2	-	deg
S/N Ratio	SNv	(CLAMP) Vin=1.0Vp-p, 100% White Video Signal (BIAS) Vin=0.7Vp-p, 100% Red field Signal	-	+60	-	dB
2nd. Distortion	Hv	(CLAMP) Vin=1.0Vp-p, 3.58MHz, Sin Signal, R _L =75Ω (BIAS) Vin=0.7Vp-p, 3.58MHz, Sin Signal, R _L =75Ω	-	-40	-	dB
SW Change Voltage High Level	VthPH		1.8	-	V ⁺	V
SW Change Voltage Low Level	VthPL		0	-	0.3	

■CONTROL TERMINAL

PARAMETER	STATUS	NOTE
Power Save	H	Power Save: ON
	L	Power Save: OFF
	OPEN	Power Save: OFF
CLAMP/BIAS SW	H	BIAS
	L	CLAMP
	OPEN	CLAMP

NJM2573

■ TEST CIRCUIT (SSOP14)

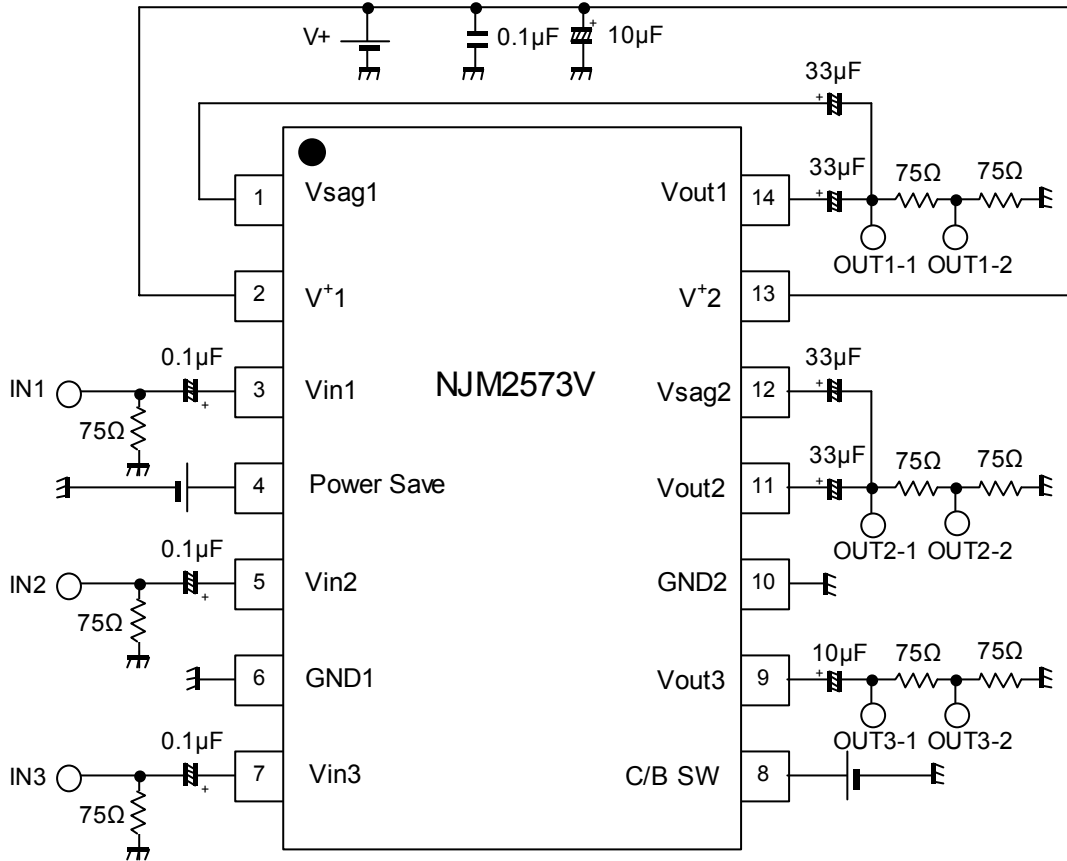

APPLICATION CIRCUIT (SSOP14, VIN2: CLAMP)

(1) Standard circuit

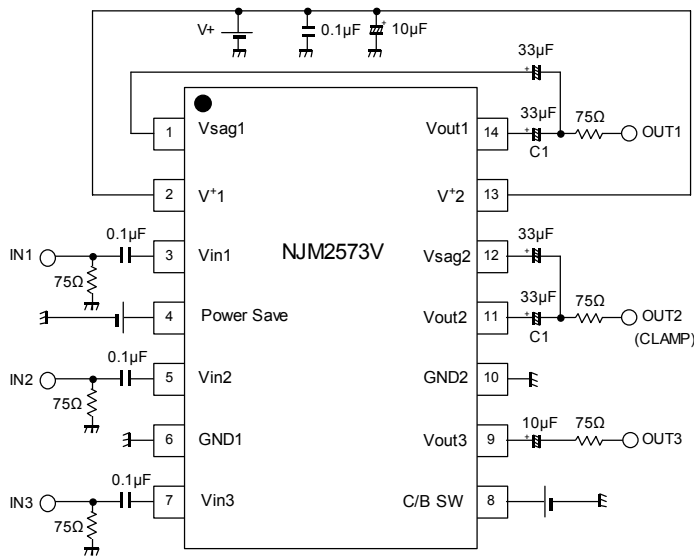

(2) SAG correction unused circuit

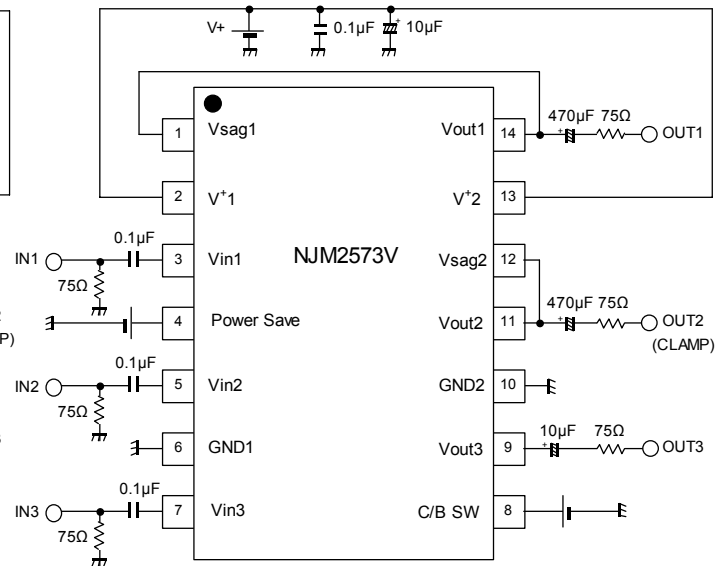

(3) Two-line driving circuit

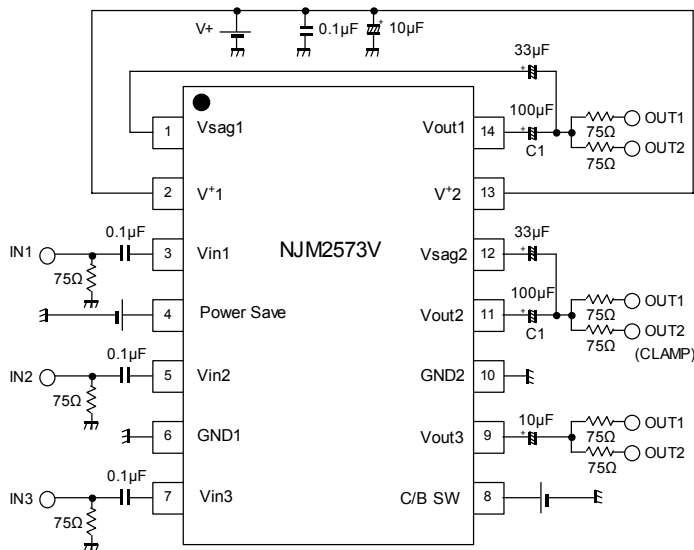

(1) Standard circuit

The SAG correction reduces output coupling capacitor values.

The capacitor of C1 (33μF) is recommended for the portable application.

However, the 33μF capacitor may deteriorate SAG, and lose synchronization by luminance fluctuation.

Adjust the C1 value, checking the waveform containing a lot of low frequency components like a bounce waveform (In case of worst condition). Change the capacitor of C1 into a large value to improve SAG.

(2) SAG correction unused circuit

Cancel the SAG correction to improve lost synchronization.

Connect the coupling capacitor after connecting the Vout pin and Vsag pin. The recommended value is 470μF or more.

(3) Two-line driving circuit

The NJM2573 drives two-line load of 150Ω.

The capacitance value of C1 should be 100μF or more, because SAG is deteriorated than a standard circuit.

NJM2573

EQUIVALENT CIRCUIT

PCSP16 PIN No.	SSOP14 PIN No.	PIN NAME	FUNCTION	INSIDE EQUIVALENT CIRCUIT
1	3	VIN1	Clamp input	
2	4	Power Save	Power save	
3	5	Vin2	Clamp/Bias input	
4	-	NC	Non connection	
5	6	GND1	GND	
6	7	Vin3	Bias input	

PCSP16 PIN No.	SSOP14 PIN No.	PIN NAME	FUNCTION	INSIDE EQUIVALENT CIRCUIT
7	8	CLAMP/ BIAS SW	Clamp/Bias switch	
8	9	Vout3	Bias output	
9	10	GND2	GND	
10	11	Vout2	Clamp/Bias output	
11	12	Vsag2	Sag compensation	
12	13	V+2	Power Supply	

PCSP16 PIN No.	SSOP14 PIN No.	PIN NAME	FUNCTION	INSIDE EQUIVALENT CIRCUIT
13	14	Vout1	Clamp output	
14	1	Vsag1	Sag compensation	
15	-	NC	Non connection	
16	2	V+1	Power Supply	

■ APPLICATION

When the power supply voltage is not impressing, don't impress voltage to the control terminal.

TYPICAL CHARACTERISTICS

Voltage Gain vs. Frequency
 $V_{in}=1.0V_{pp}$

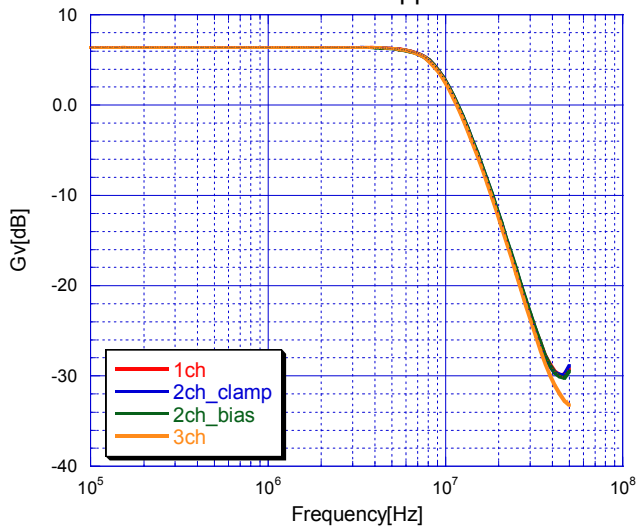

V^+ vs I_{cc}

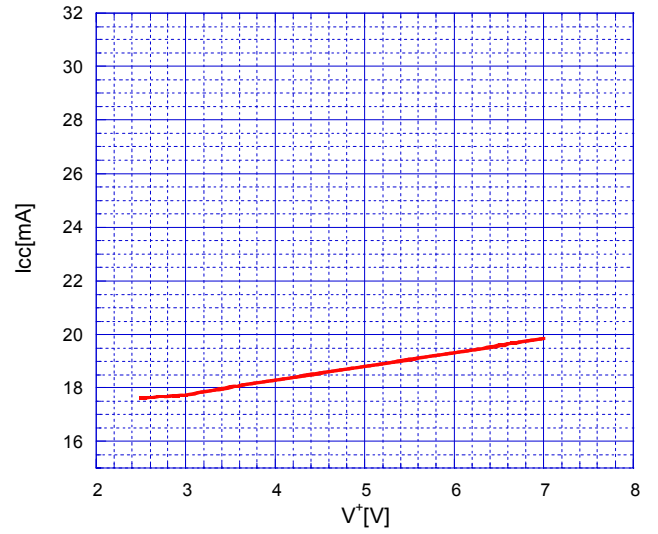

V^+ vs I_{save}

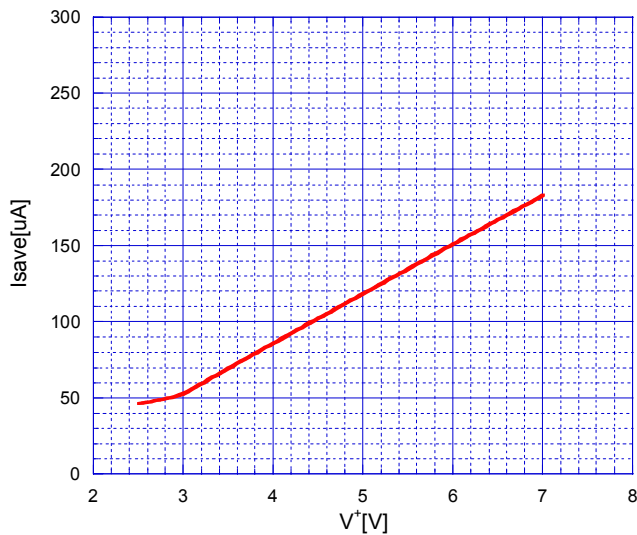

V^+ vs V_{omc}

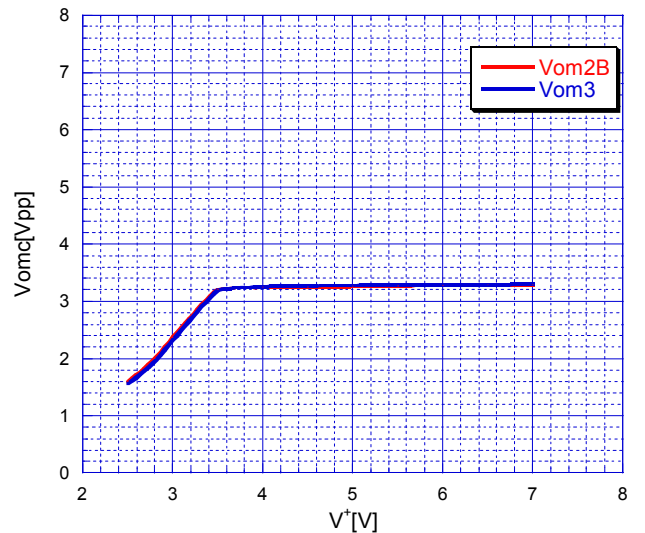

V^+ vs V_{omv}

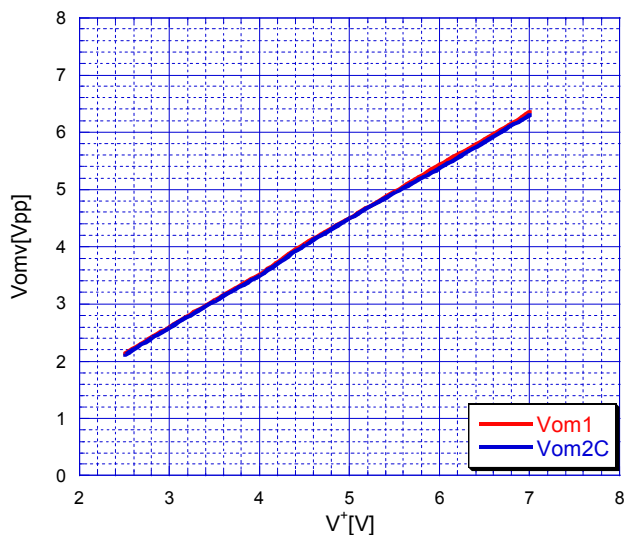

V^+ vs G_v

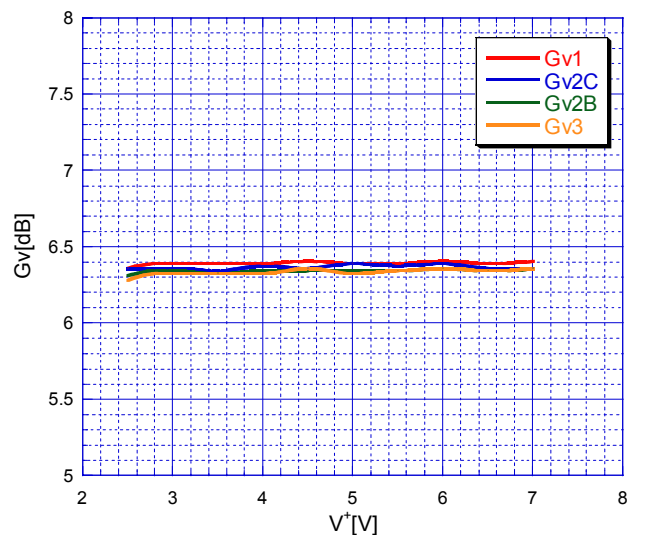

V⁺ vs Gfy_{4.5M}

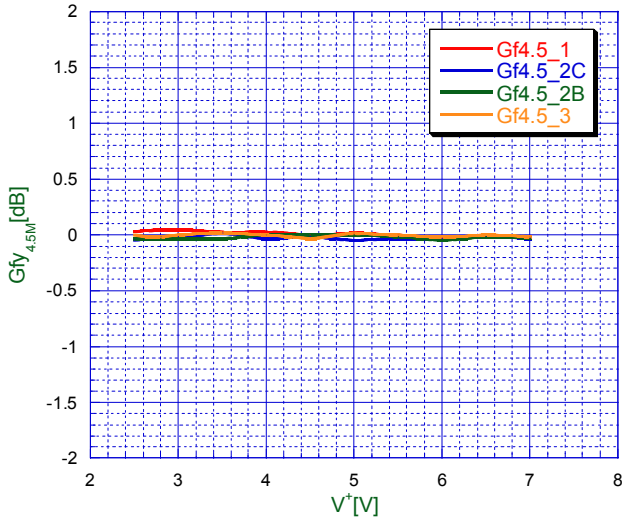

V⁺ vs Gfy_{8M}

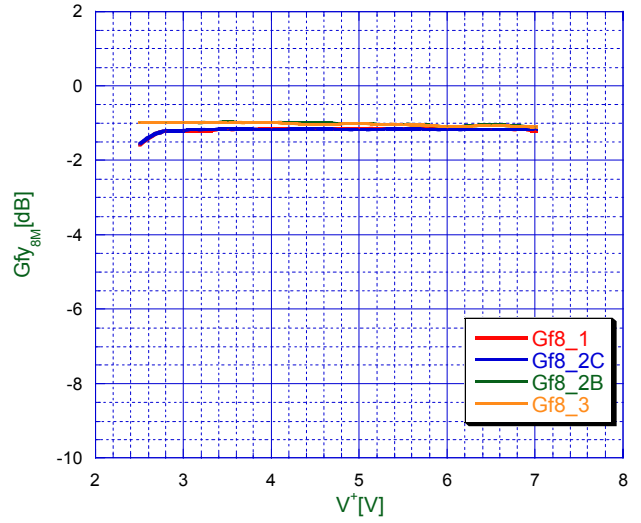

V⁺ vs Gfy_{16M}

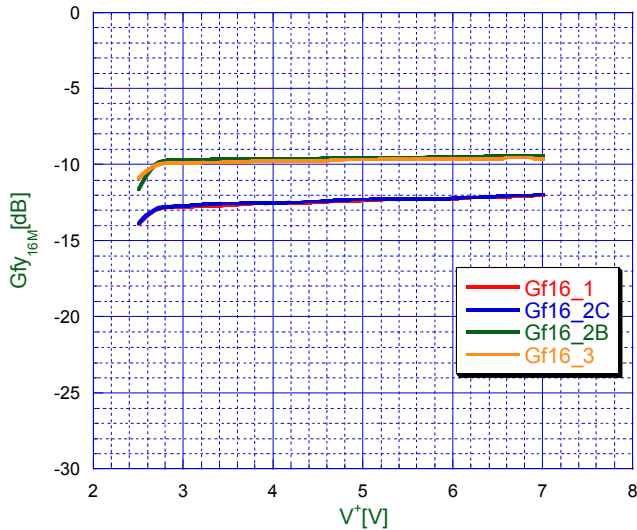

V⁺ vs DG

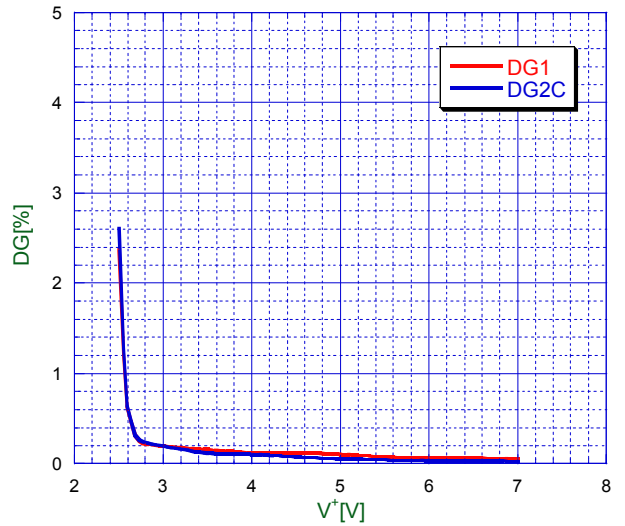

V⁺ vs DP

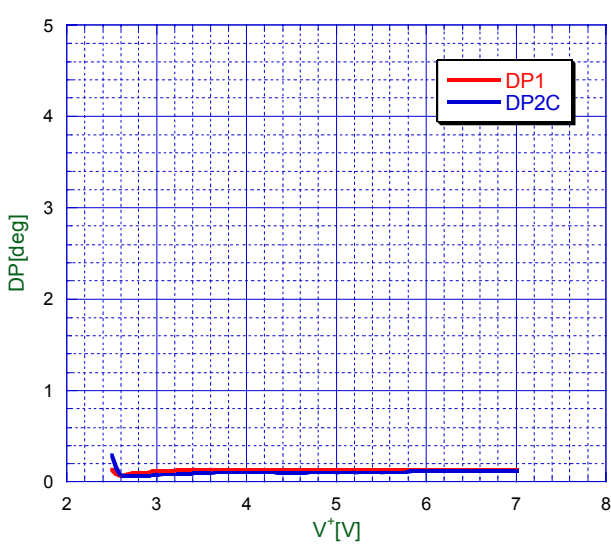

V⁺ vs CTave

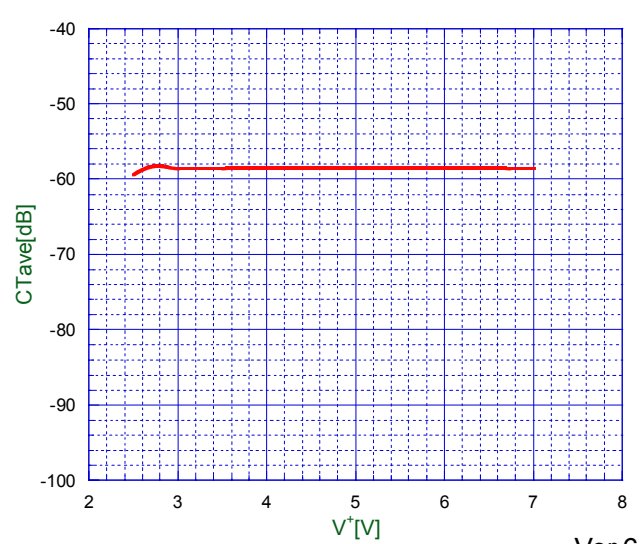

V⁺ vs SNv

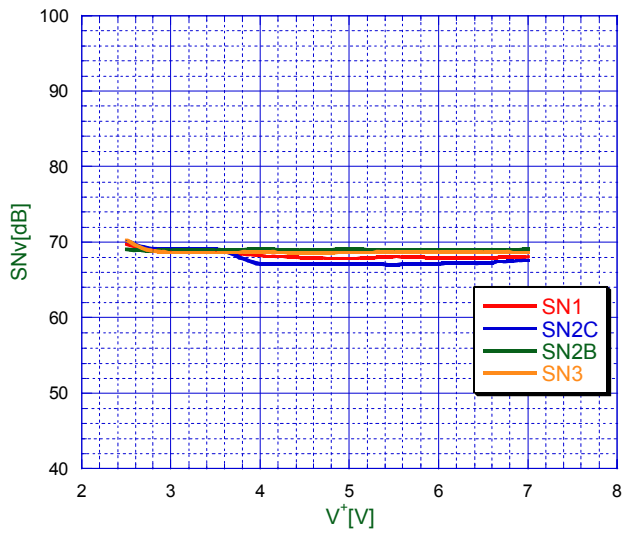

V⁺ vs Hv

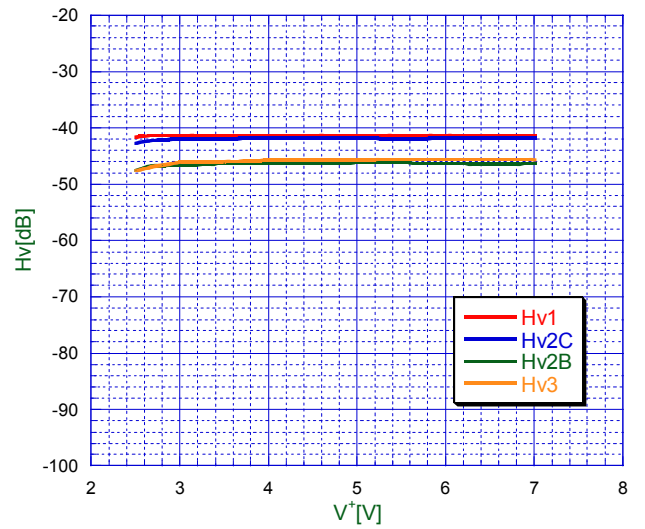

V⁺ vs VthHL

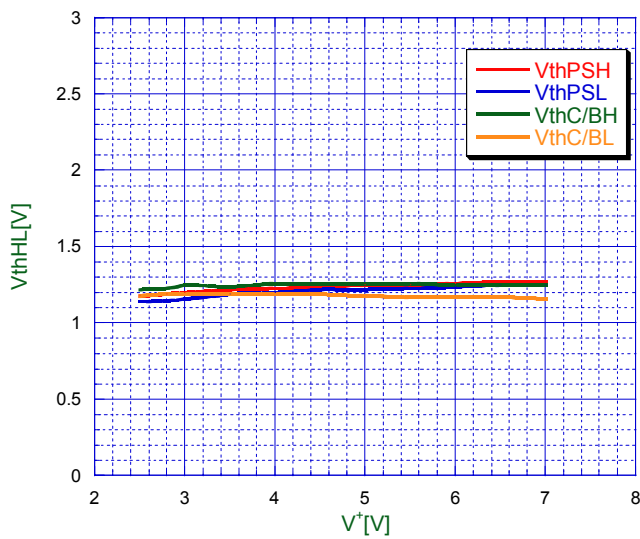

T vs Icc

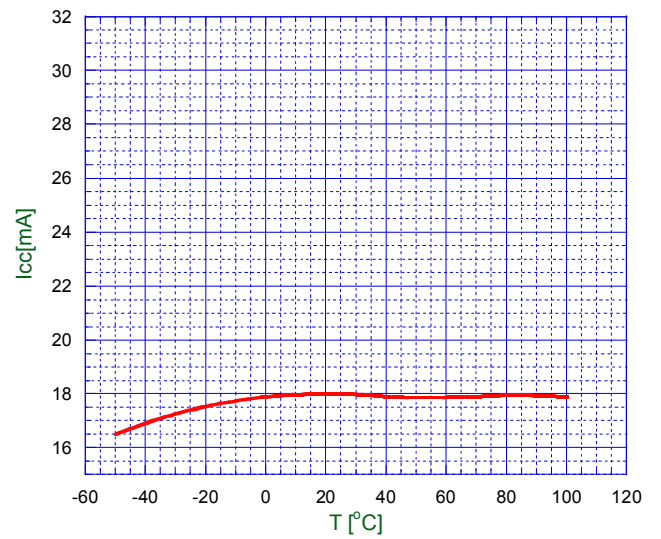

T vs Isave

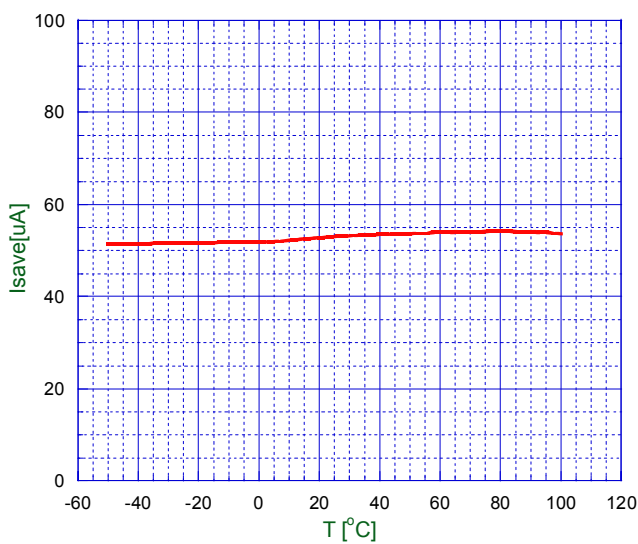

T vs Vomc

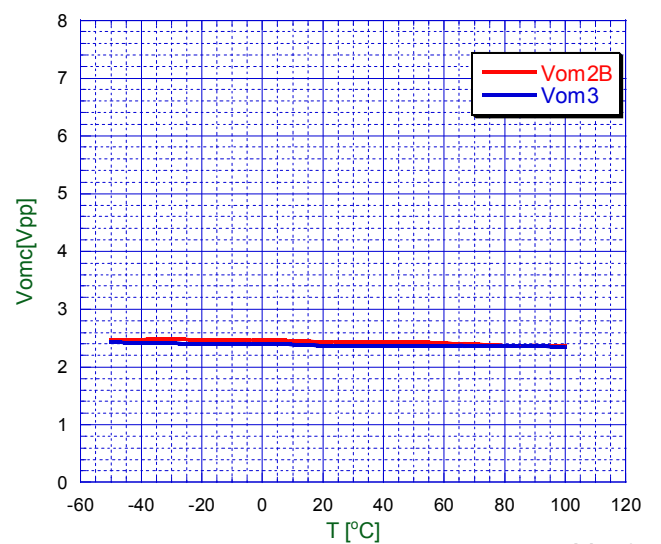

T vs Vomv

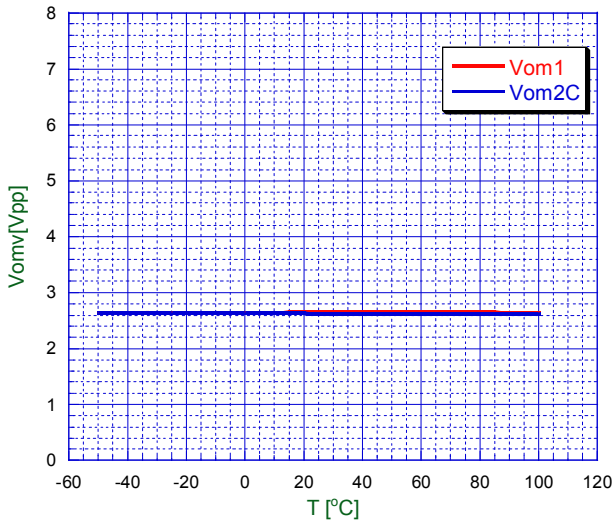

T vs Gv

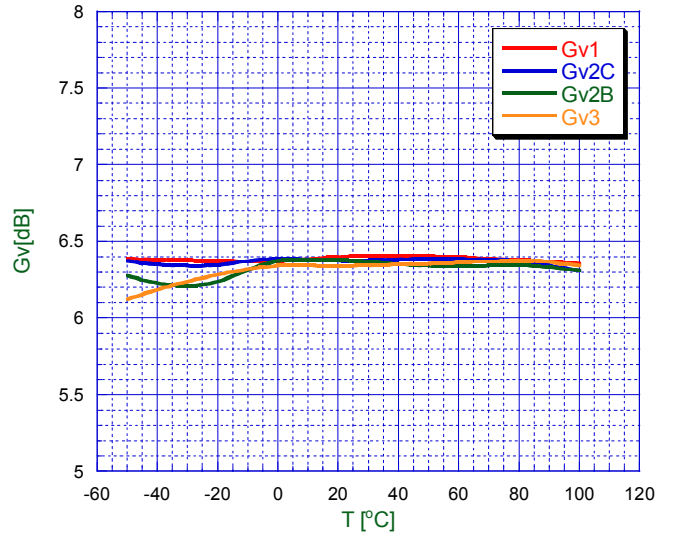

T vs Gfy_{4.5M}

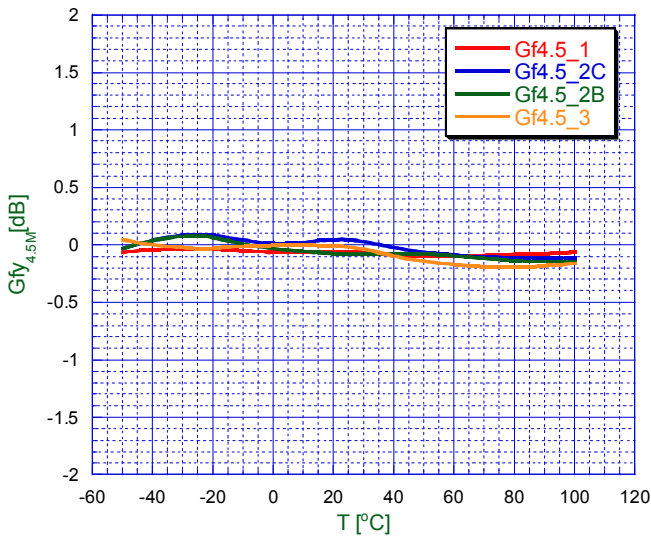

T vs Gfy_{8M}

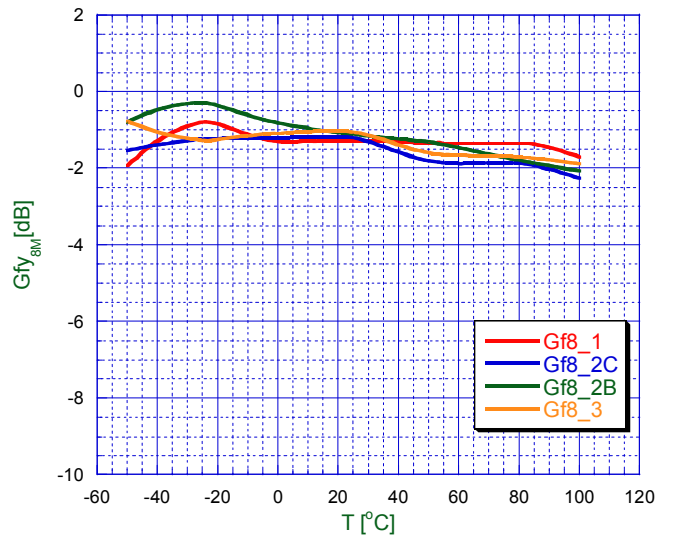

T vs Gfy_{16M}

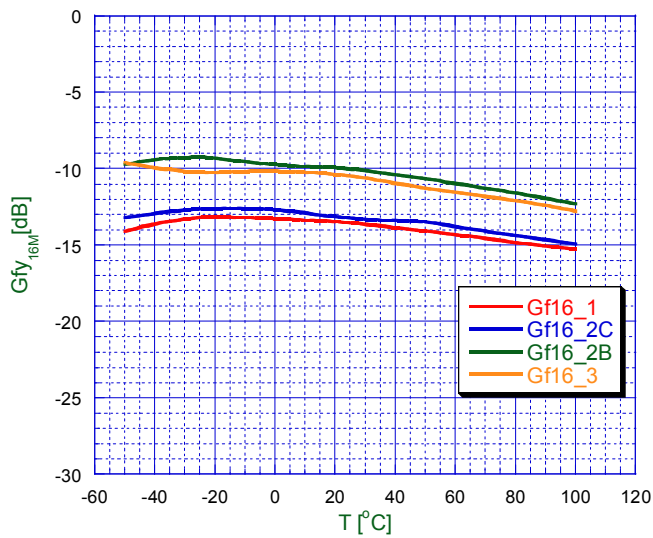

T vs DG

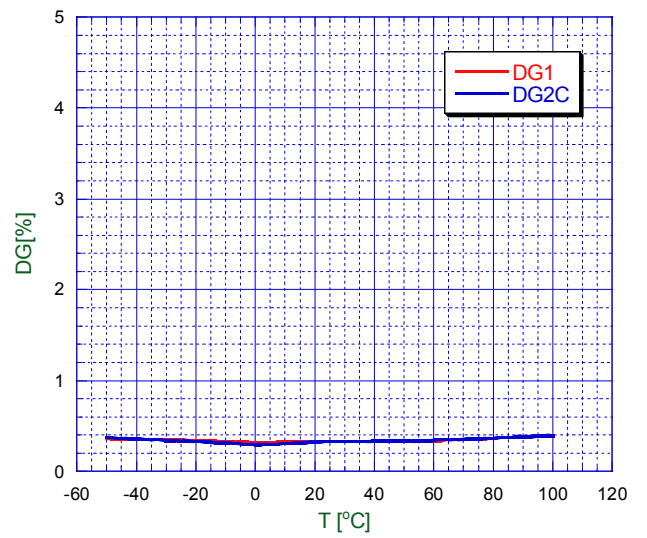

T vs DP

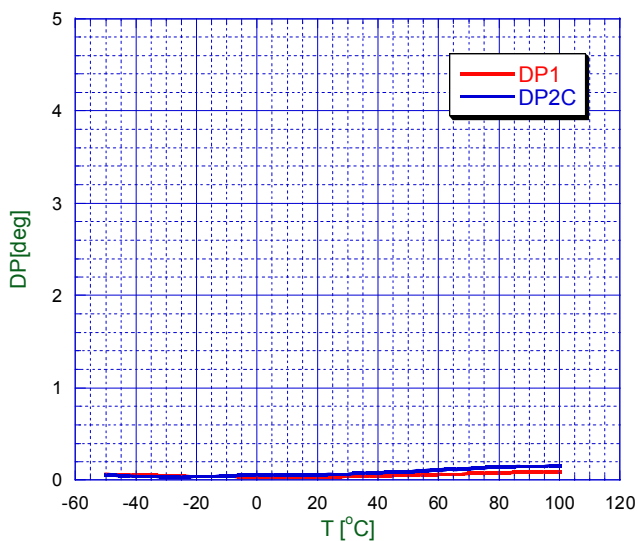

T vs CTave

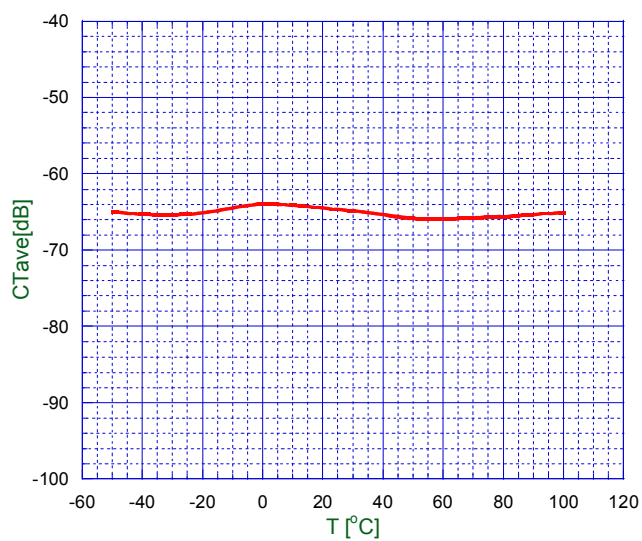

T vs SNv

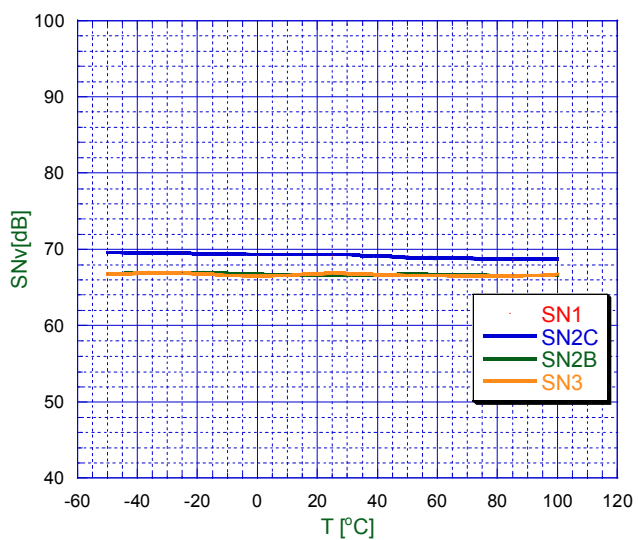

T vs Hv

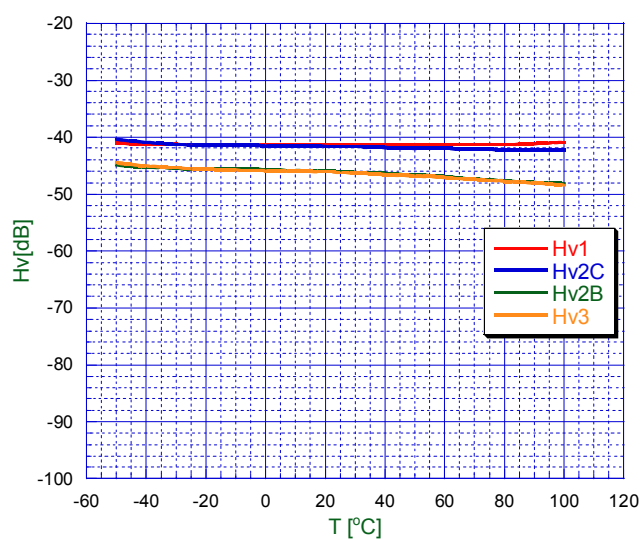

T vs VthHL

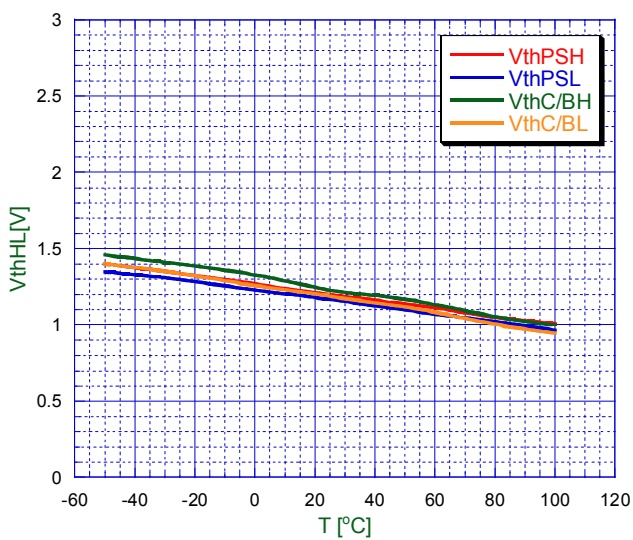

[CAUTION]
 The specifications on this databook are only given for information, without any guarantee as regards either mistakes or omissions. The application circuits in this databook are described only to show representative usages of the product and not intended for the guarantee or permission of any right including the industrial rights.

X-ON Electronics

Largest Supplier of Electrical and Electronic Components

Click to view similar products for [Video ICs category](#):

Click to view products by [Nisshinbo manufacturer](#):

Other Similar products are found below :

[M21328G-12](#) [TW2964-LA2-CR](#) [TW9903-FB](#) [TW9919-PE1-GR](#) [ADV8003KBCZ-7T](#) [PI3HDX511DZLEX](#) [M23428G-33](#)
[PI7VD9008ABHFDE](#) [ADV7186BBCZ-TL](#) [ADV7186BBCZ-T-RL](#) [ADV8003KBCZ-7C](#) [PI3VDP411LSAZBEX](#) [PI3VDP411LSTZBEX](#)
[M23145G-14](#) [PI3VDP411LSRZBEX](#) [PI3HDX511EZLSEX](#) [BH76912GU-E2](#) [CM5100-01CP](#) [TVP5160PNP](#) [TVP5151PBSR](#) [BA7603F-E2](#)
[MU82645DES S LM6B](#) [BH76106HFV-TR](#) [BH76206HFV-TR](#) [ADV7179WBCPZ](#) [ADV7611BSWZ-P-RL](#) [ADV7180KCP32Z](#)
[ADV7180WBCP32Z](#) [ADV7182WBCPZ](#) [ADV7280KCPZ](#) [ADV7280WBCPZ-M](#) [ADV7281WBCPZ-MA](#) [ADV7283WBCPZ](#) [ADV7283BCPZ](#)
[ADV7282WBCPZ-M](#) [ADV7280KCPZ-M](#) [ADV7280WBCPZ](#) [ADV7180KCP32Z-RL](#) [ADV7282AWBCPZ](#) [ADV7182AWBCPZ](#)
[AD723ARUZ](#) [ADV7611BSWZ](#) [ADV7181DWBCPZ-RL](#) [ADV7173KSTZ-REEL](#) [ADV7180WBST48Z-RL](#) [ADA4411-3ARQZ](#) [ADA4411-3ARQZ-R7](#) [ADA4417-3ARMZ](#) [ADA4417-3ARMZ-R7](#) [ADA4424-6ARUZ](#)