

## LOW VOLTAGE VIDEO AMPLIFIER WITH LPF

### ■GENERAL DESCRIPTION

The **NJM2574** is a Low Voltage Video Amplifier contained LPF circuit, 75Ω driver and internal CLAMP/BIAS SW, LPF/through SW to connect TV monitor directly.

The input composite signal.(0.5Vpp) The mute circuit with power save function is suitable for low power design.

The **NJM2574** is suitable for down sizing of Digital Steel Camera, and DVC for small package.

### ■PACKAGE OUTLINE

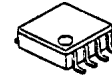

**NJM2574RB1**

### ■FEATURES

- Operating Voltage 2.8 to 5.5V
- Input Composite Signal 0.5Vpp
- 12dB Amplifier
- 75Ω Driver
- Internal CLAMP/BIAS SW
- Internal LPF/through SW
- Operating Current 9.0mA typ. at Vcc=3.0V
- Operating Current in Battery Saving 70μAtyp. at Vcc=3.0V
- Bipolar Technology
- Package Outline TVSP8

### ■BLOCK DIAGRAM

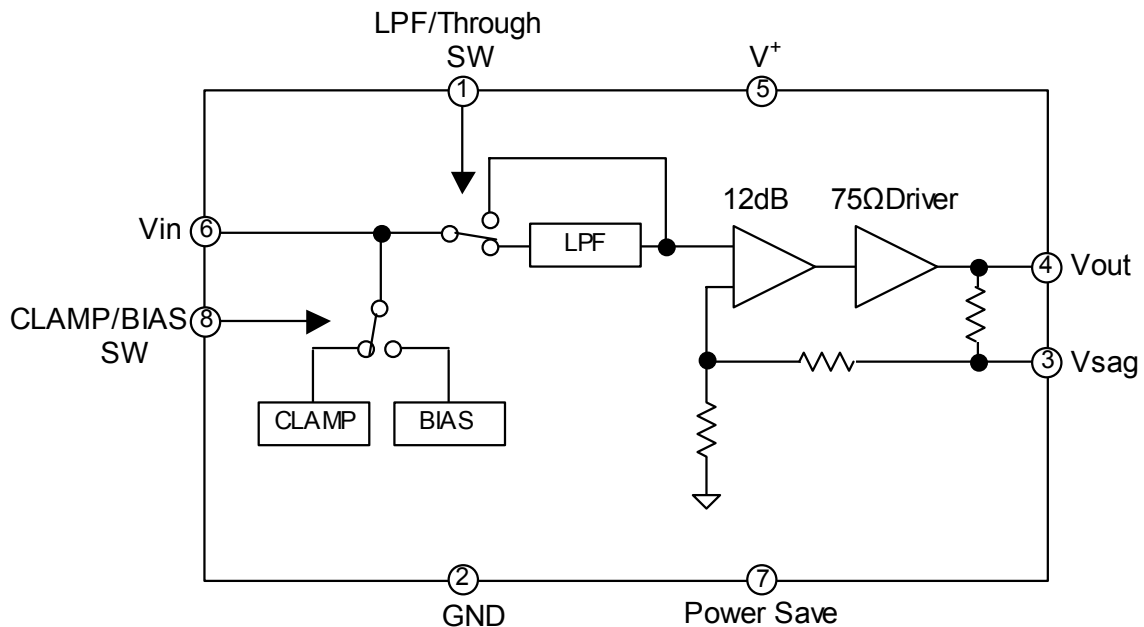

# NJM2574

## ■ABSOLUTE MAXIMUM RATINGS

(Ta=25°C)

PARAMETER	SYMBOL	RATINGS	UNIT
Supply Voltage	V <sup>+</sup>	7.0	V
Power Dissipation	P <sub>D</sub>	320	mW
Operating Temperature Range	T <sub>opr</sub>	-40 to +85	°C
Storage Temperature Range	T <sub>stg</sub>	-40 to +125	°C

## ■ELECTRICAL CHARACTERISTICS ( V<sup>+</sup>=3.0V,RL=150Ω,Ta=25°C)

PARAMETER	SYMBOL	TEST CONDITION	MIN.	TYP.	MAX.	UNIT
Operating Voltage	V <sub>opr</sub>		2.8	3.0	5.5	V
Operating Current	I <sub>cc</sub>	No Signal	-	9.0	10.0	mA
Operating Current at Power Save	I <sub>save</sub>	Power Save Mode	-	70	90	μA
Maximum Output Voltage Swing	V <sub>omv</sub>	f=1kHz,THD=1%,CLAMP MODE LPF MODE	2.2	2.7	-	Vp-p
	V <sub>om</sub> RGB	f=1kHz,THD=1%, BIAS MODE, through MODE	1.4	2.0	-	
Voltage Gain	G <sub>v</sub>	V <sub>in</sub> =100kHz,0.5Vp-p, Input Sine Signal	12.0	12.4	12.8	dB
Frequency Characteristic (Through MODE)	G <sub>f</sub>	V <sub>in</sub> =20MHz/100kHz,0.5Vp-p	-6.0	-3.0	-	dB
Low Pass Filter Characteristic	G <sub>fy</sub> 4.5M	V <sub>in</sub> =4.5MHz/100kHz,0.5Vp-p	-0.95	-0.45	0.05	dB
	G <sub>fy</sub> 8M	V <sub>in</sub> =8MHz/100kHz,0.5Vp-p	-	-3.0	-	
	G <sub>fy</sub> 23.5M	V <sub>in</sub> =23.5MHz/100kHz,0.5Vp-p	-	-23	-17	
Differential Gain	DG	V <sub>in</sub> =0.5Vp-p, Input 10step Video Signal	-	0.5	-	%
Differential Phase	DP	V <sub>in</sub> =0.5Vp-p, Input 10step Video Signal	-	0.5	-	deg
S/N	SN <sub>v</sub>	V <sub>in</sub> =0.5Vp-p, 100% White Video Signal, R <sub>L</sub> =75Ω Band Width 100kHz to 6MHz	-	60	-	dB
2nd. Distortion	H <sub>v</sub>	V <sub>in</sub> =0.5Vp-p, 3.58MHz, Sine Video Signal, R <sub>L</sub> =75Ω,	-	-60	-	dB
SW Change Voltage High Level	V <sub>thH</sub>		1.8	-	V <sup>+</sup>	V
SW Change Voltage Low Level	V <sub>thL</sub>		0	-	0.3	

## ■ CONTROL TERMINAL

PARAMETER	STATUS	NOTE
Power Save(7pin)	H	Power Save : OFF
	L	Power Save : ON (Mute)
	OPEN	Power Save : ON (Mute)
LPF/Through SW(1pin)	H	LPF MODE
	L	Through MODE
	OPEN	Through MODE
CLAMP/BIAS SW(8pin)	H	CLAMP MODE
	L	BIAS MODE
	OPEN	BIAS MODE

## TEST CIRCUIT

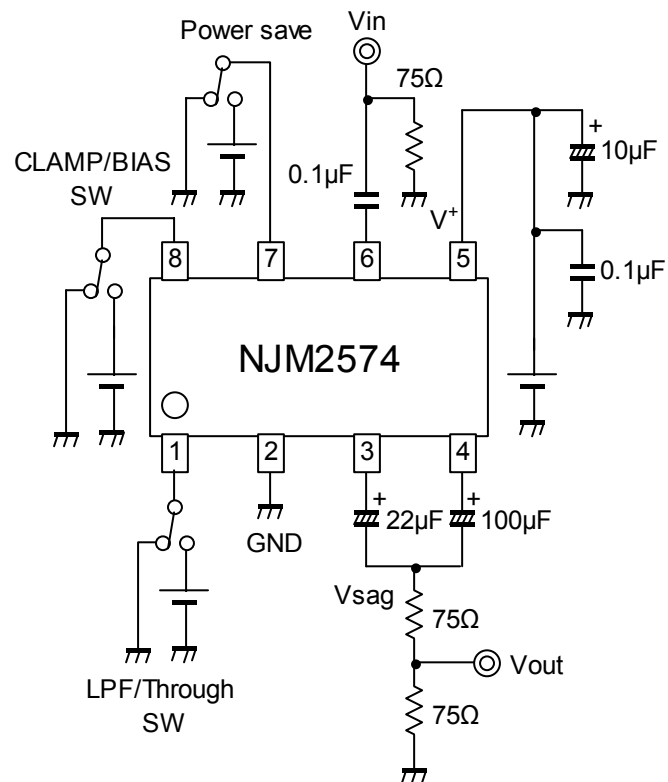

# NJM2574

## APPLICATION CIRCUIT

### (1) Standard circuit

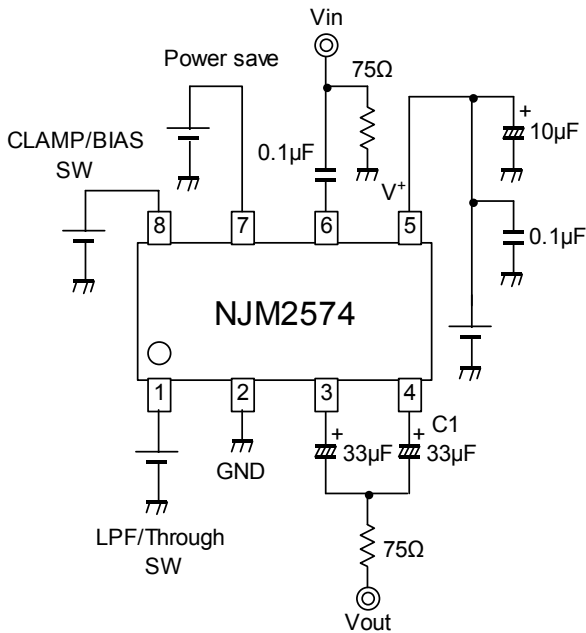

### (2) SAG correction unused circuit

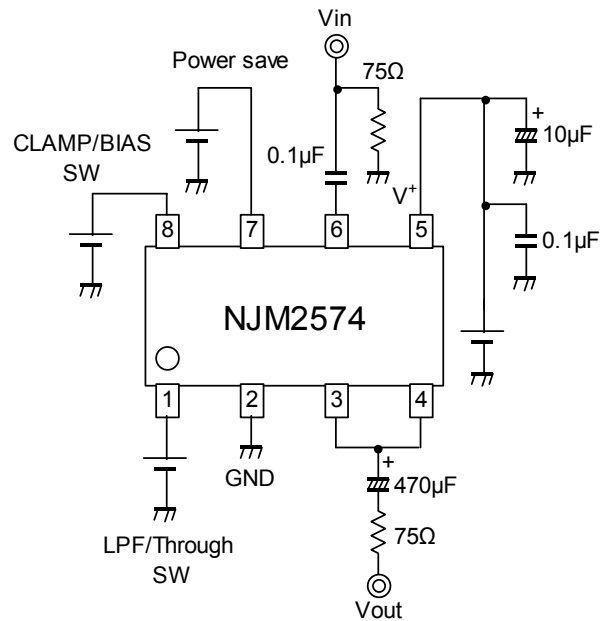

### (3) Two-line driving circuit

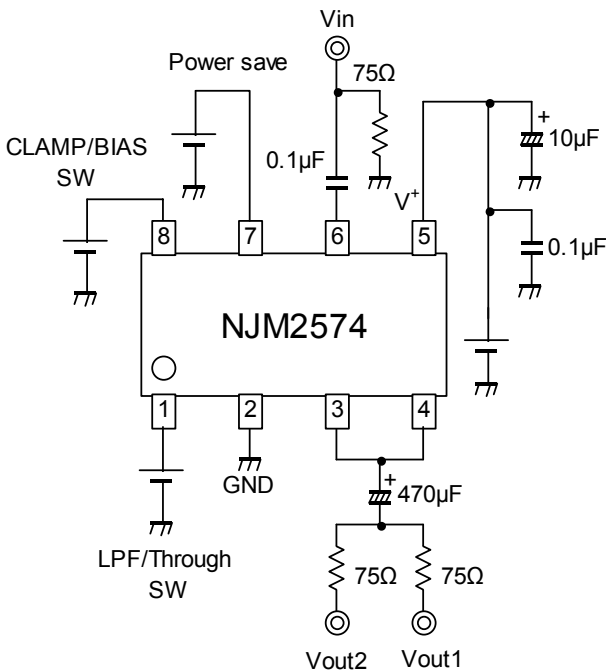

#### (1) Standard circuit

This circuit is for a portable equipment of small mounting space.

The SAG correction reduces output coupling capacitor values.

However, this circuit may cause to SAG deterioration, and lose synchronization by luminance fluctuation.

Adjust the C1 value, checking the waveform containing a lot of low frequency components like a bounce waveform (Worst condition waveform of SAG). Change the capacitor of C1 into a large value to improve SAG.

#### (2) SAG correction unused circuit

We recommend this circuit when there is no space limitation.

Connect the coupling capacitor after connecting the Vout pin and Vsag pin. The recommended value is 470μF or more.

#### (3) Two-line driving circuit

This circuit drives two-line of 150Ω. However, it may cause to lose synchronization by an input signal of large APL change (100% white signals more than 1Vp-p). Confirm the large APL change waveform (100% white signals more than 1Vp-p) and evaluate sufficiently.

## ■ APPLICATION (IC characteristic is not guaranteed)

When you use a power save terminal more than by 4.0V, please put resistance of about 20kΩ into a power save terminal.

Resistance is unnecessary in the following condition.

1. The power save terminal voltage (VthH) is less than 4.0V.
2. When you select "BIAS" at the power-supply voltage of 5V.

Example)

● PS(VthH) ≥ 4.0V

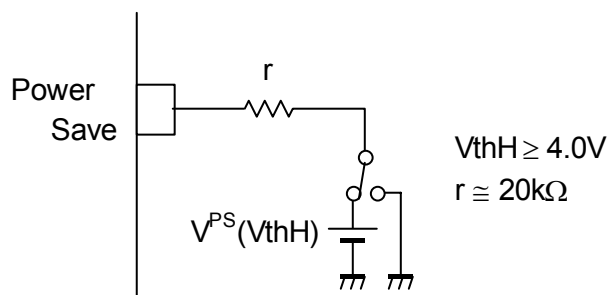

● PS(VthH) < 4.0V

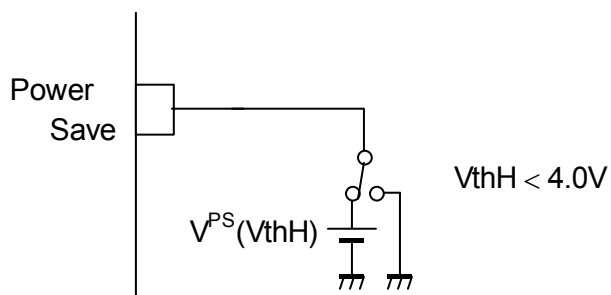

# NJM2574

## ■ TYPICAL CHARACTERISTICS

Voltage Gain vs. Frequency

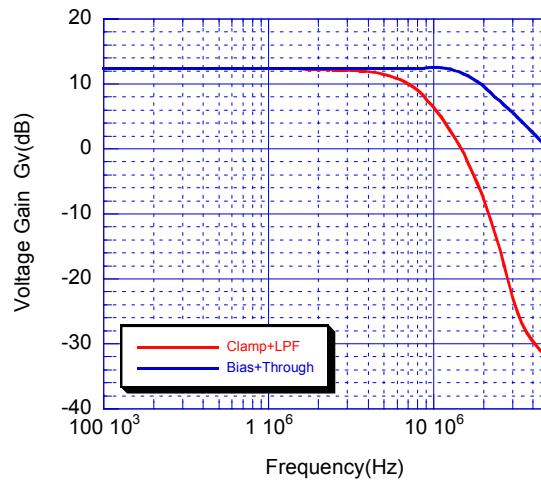

Voltage Gain vs. Frequency  
(Clamp+LPF Input)

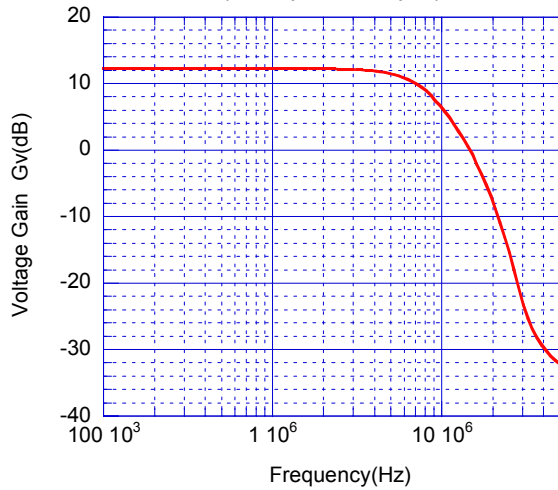

Voltage Gain vs. Frequency  
(Bias+Through Input)

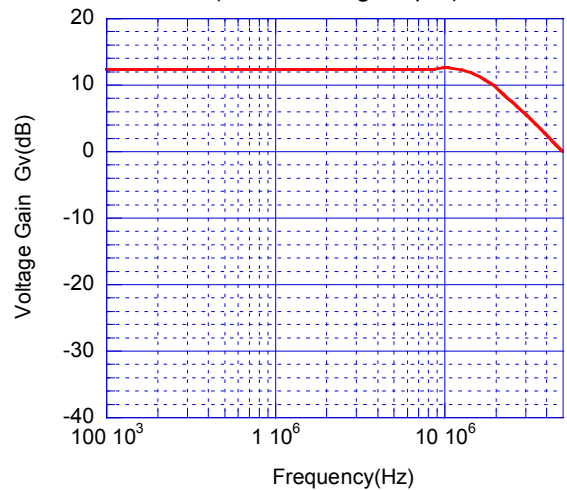

Operating Current vs. Supply Voltage  
Condition: CLAMP+LPF INPUT

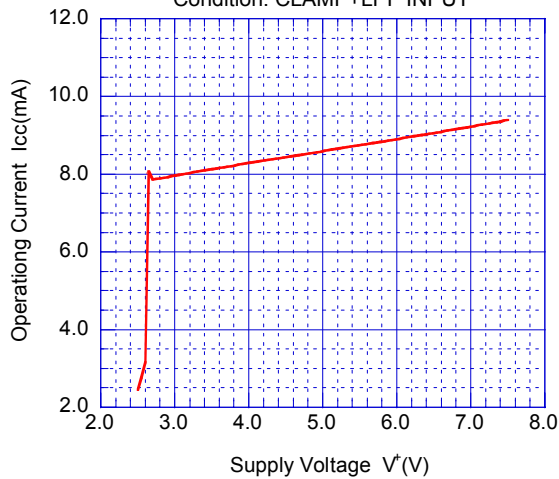

Operating Current at Standby State  
vs. Supply Voltage

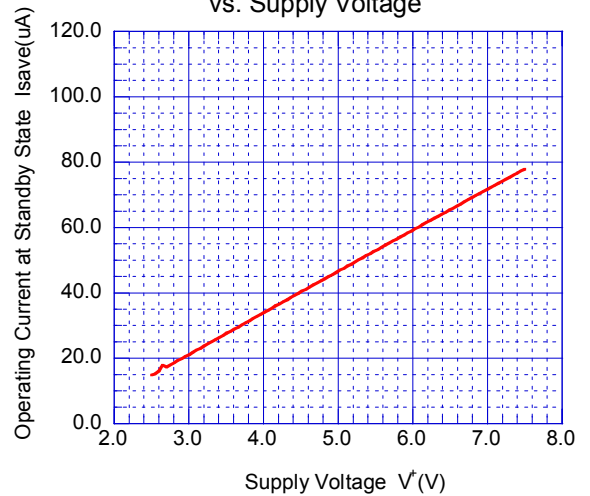

## ■ TYPICAL CHARACTERISTICS

Maximum Output Voltage Swing vs. Supply Voltage  
(Clamp+LPF Type Input)

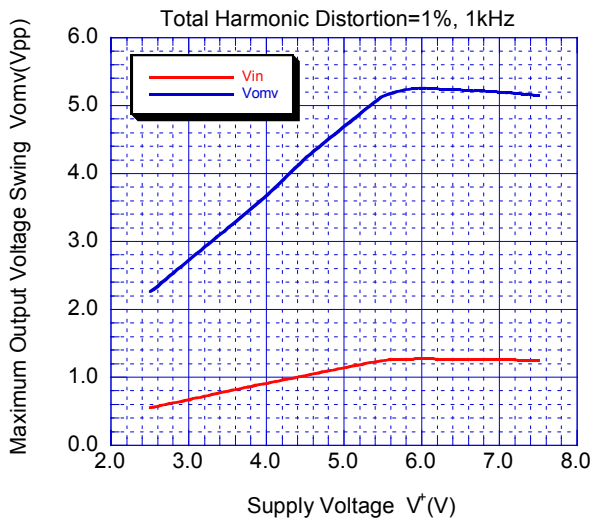

Maximum Output Voltage Swing vs. Supply Voltage  
(Bias+Through Type Input)

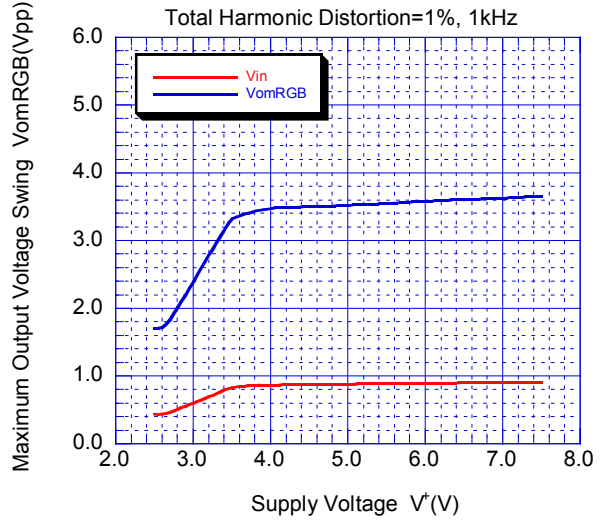

Voltage Gain vs. Supply Voltage  
0.5Vpp, 100kHz sinewave signal input

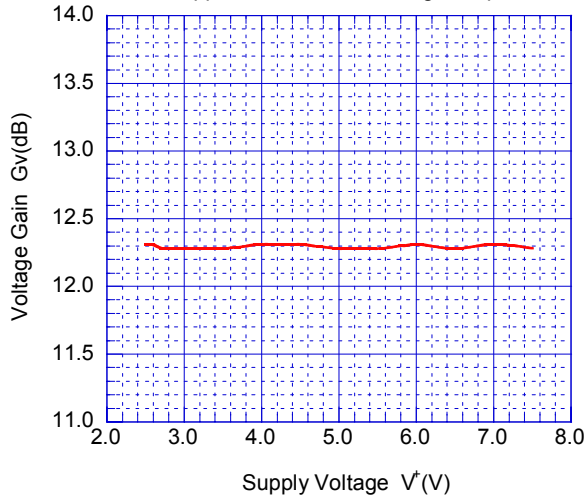

Gain Frequency Characteristics vs. Supply Voltage  
(Bias+Through Type Input)

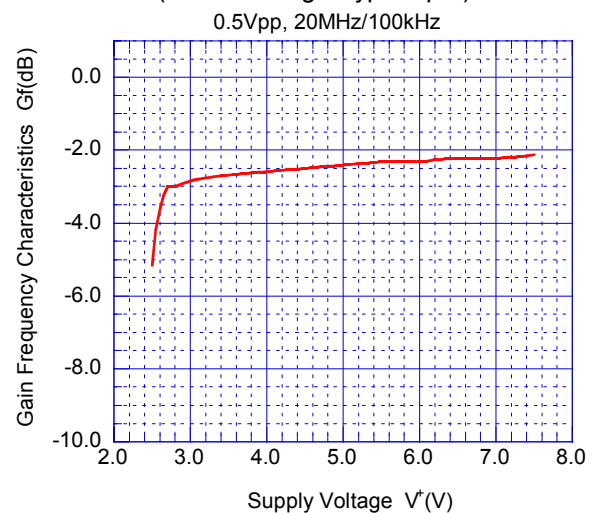

Low Pass Filter Characteristic 1 vs. Supply Voltage  
(Clamp+LPF Type Input)

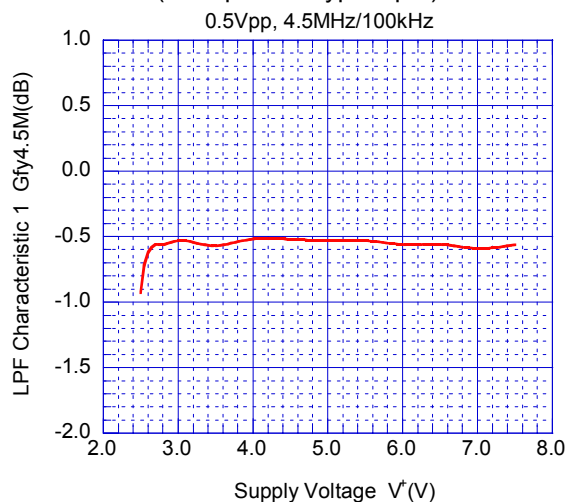

Low Pass Filter Characteristic 2 vs. Supply Voltage  
(Clamp+LPF Type Input)

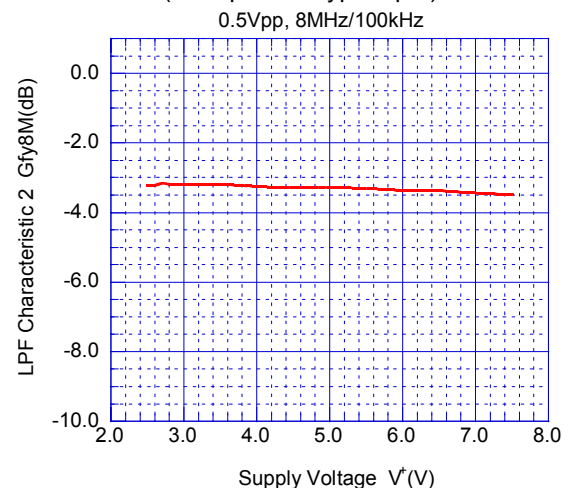

## ■ TYPICAL CHARACTERISTICS

Low Pass Filter Characteristic 3 vs. Supply Voltage  
(Clamp+LPF Type Input)  
0.5Vpp, 23.5MHz/100kHz

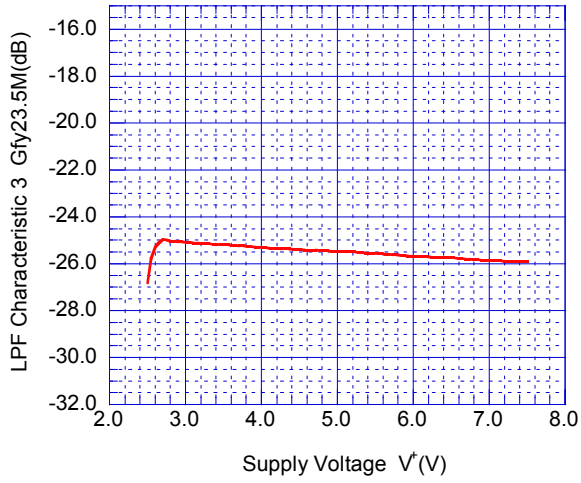

Differential Gain vs. Supply Voltage  
0.5Vpp, 10step video signal input

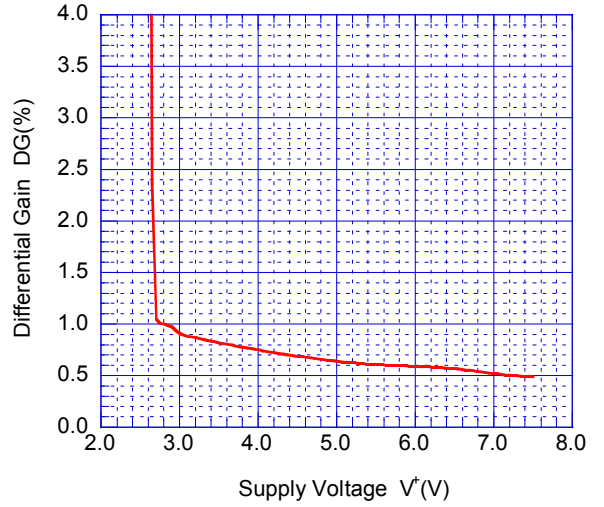

Differential Phase vs. Supply Voltage  
0.5Vpp, 10step video signal input

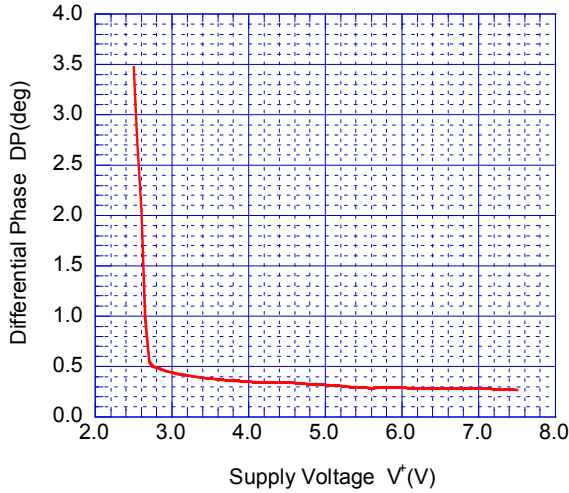

Signal to Noise Ratio vs. Supply Voltage  
0.5Vpp, 100% white video signal input, 100kHz-6MHz

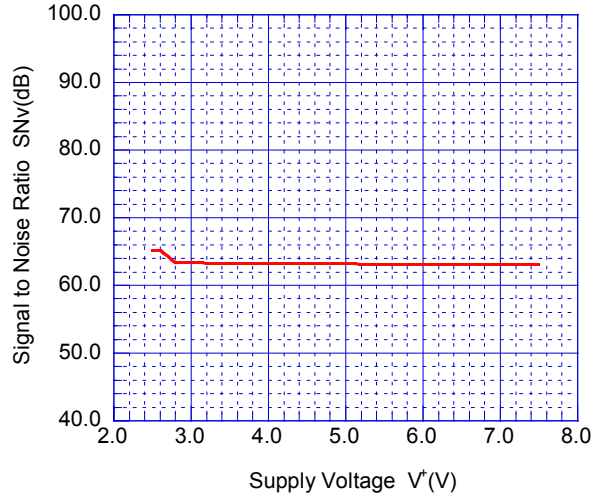

Second Harmonic Distortion vs. Supply Voltage  
0.5Vpp, 3.58MHz sinewave signal input

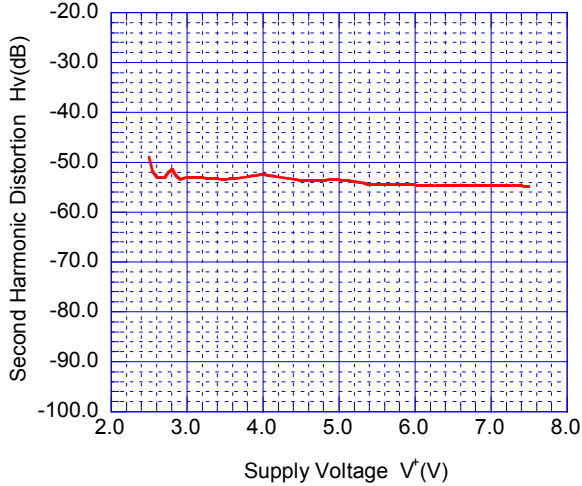

Switching Voltage vs. Supply Voltage

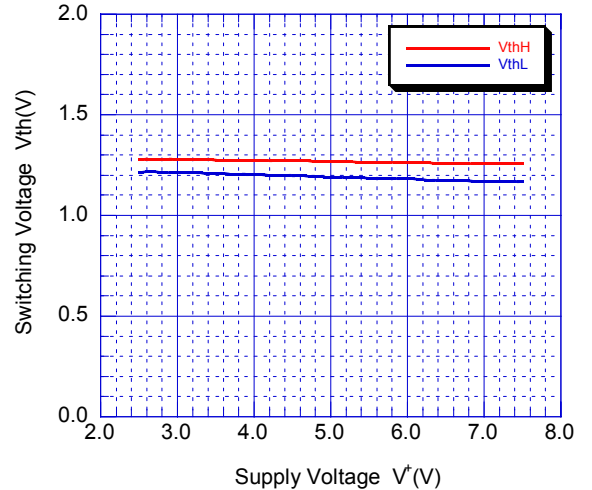



## ■ TYPICAL CHARACTERISTICS

PowerSave Switching Voltage vs. Supply Voltage

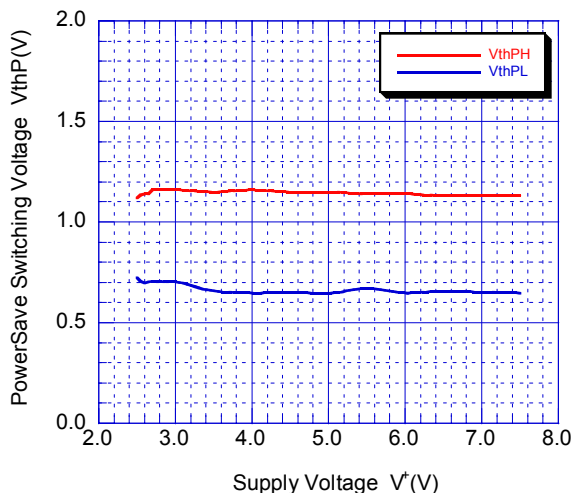

Operating Current vs. Temperature

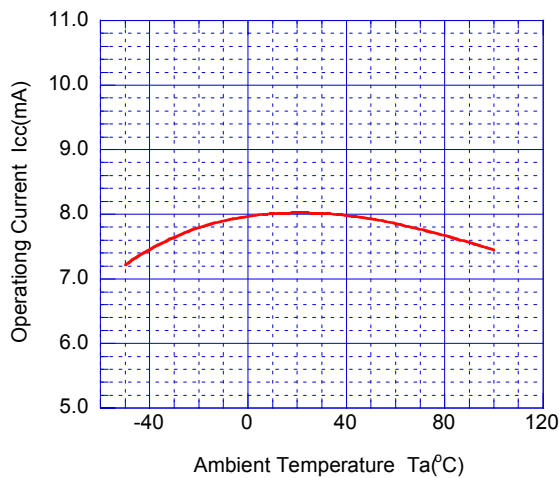

Operating Current at Standby State vs. Temperature

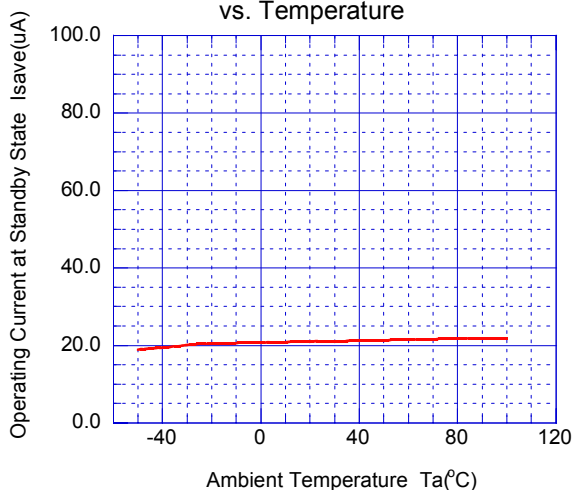

Maximum Output Voltage Swing vs. Temperature (Clamp+LPF Type Input)

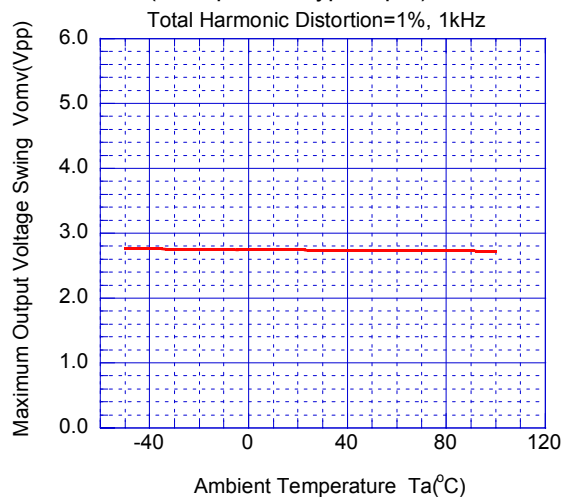

Maximum Output Voltage Swing vs. Temperature (Bias+Through Type Input)

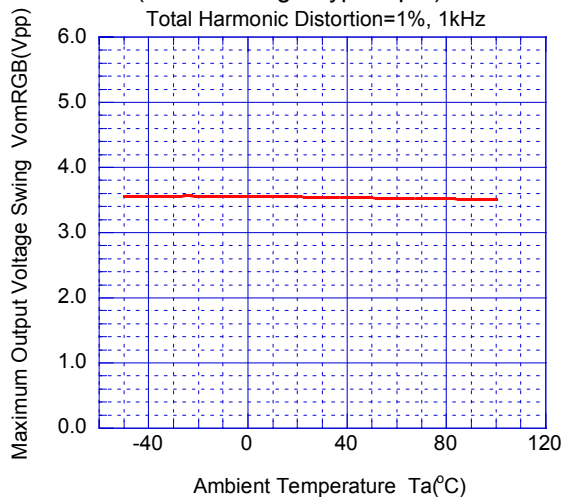

Gain Frequency Characteristics vs. Temperature (Bias+Through Type Input)

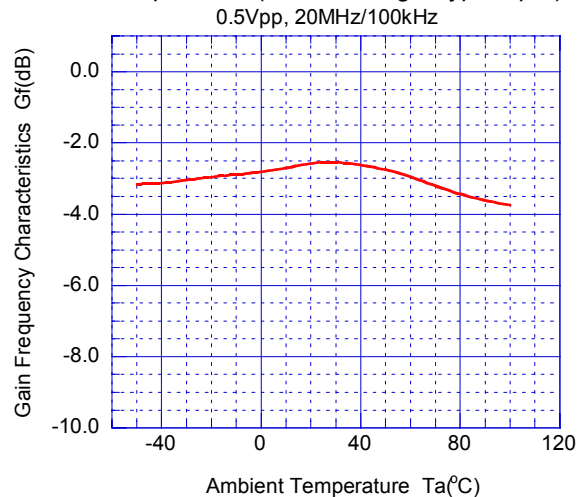

# NJM2574

## ■ TYPICAL CHARACTERISTICS

Low Pass Filter Characteristic 1 vs. Temperature  
(Clamp+LPF Type Input)  
0.5Vpp, 4.5MHz/100kHz

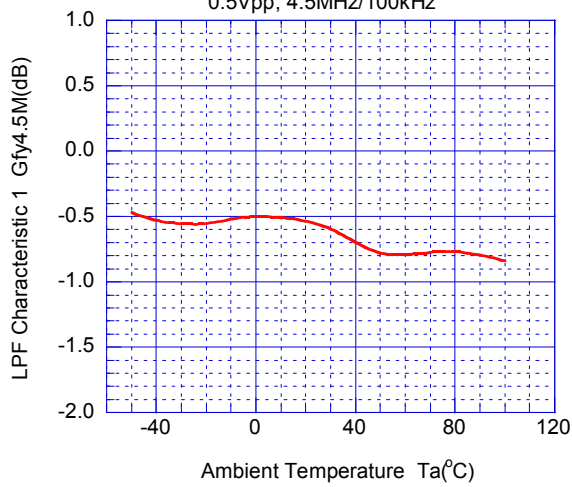

Low Pass Filter Characteristic 2 vs. Temperature  
(Clamp+LPF Type Input)  
0.5Vpp, 8MHz/100kHz

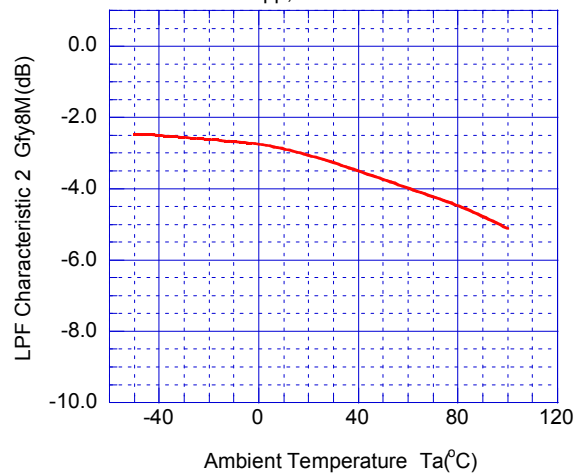

Low Pass Filter Characteristic 3 vs. Temperature  
(Clamp+LPF Type Input)  
0.5Vpp, 23.5MHz/100kHz

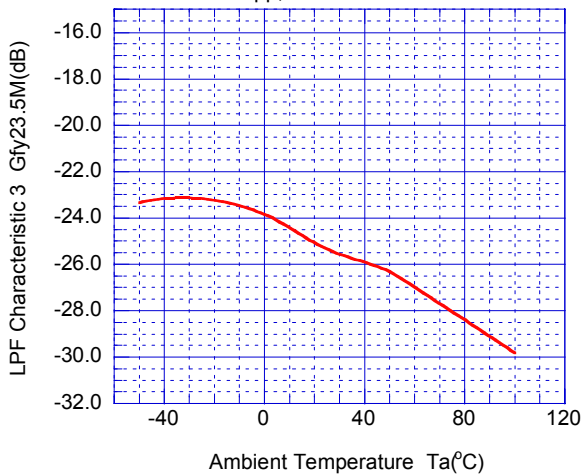

Differential Gain vs. Temperature  
0.5Vpp, 10step video signal input

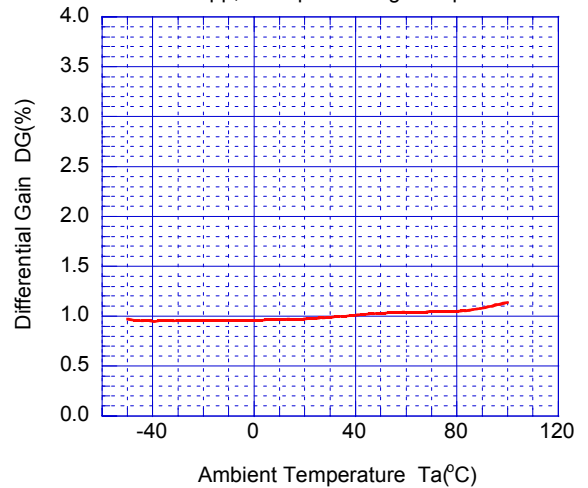

Differential Phase vs. Temperature  
0.5Vpp, 10step video signal input

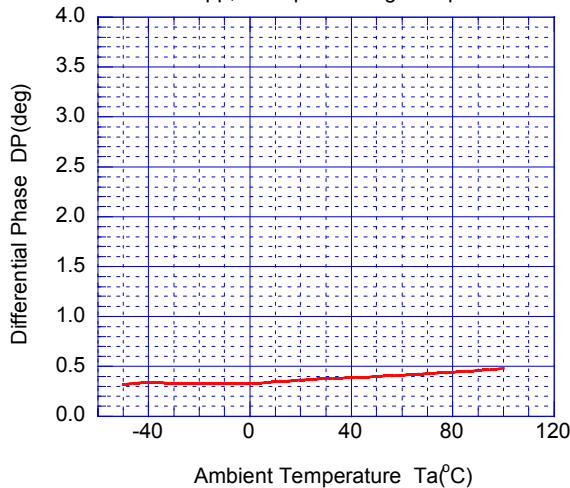

Signal to Noise Ratio vs. Temperature  
0.5Vpp, 100% white video signal input, 100kHz-6MHz

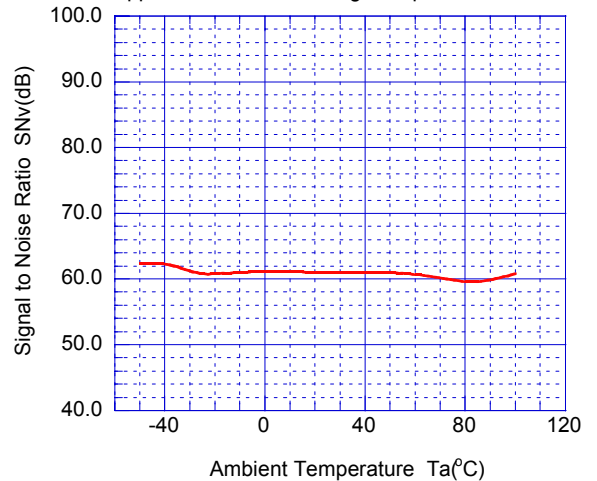

## ■ TYPICAL CHARACTERISTICS

Second Harmonic Distortion vs. Temperature  
0.5Vpp, 3.58MHz sinewave signal input

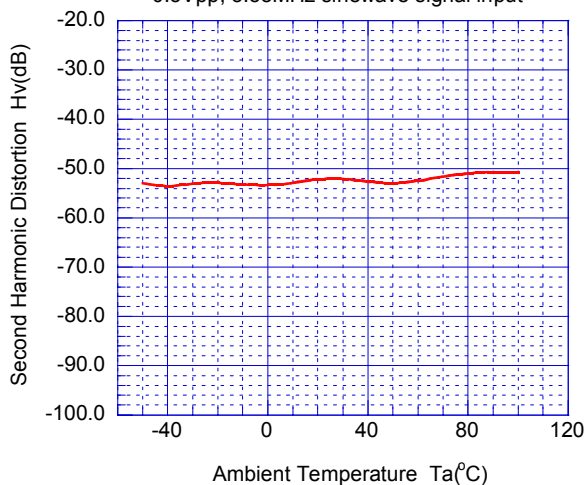

Switching Voltage vs. Temperature

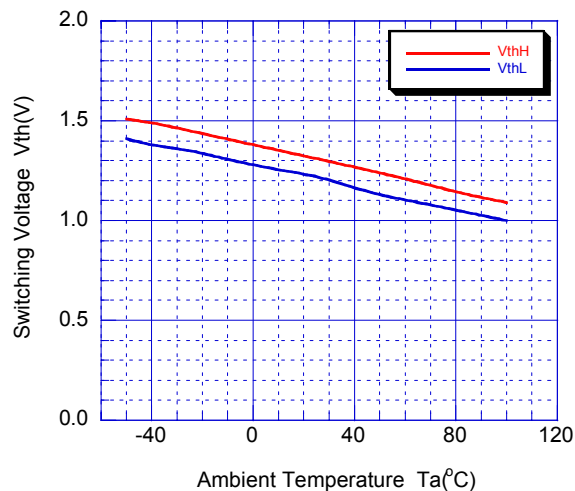

PowerSave Switching Voltage vs. Temperature

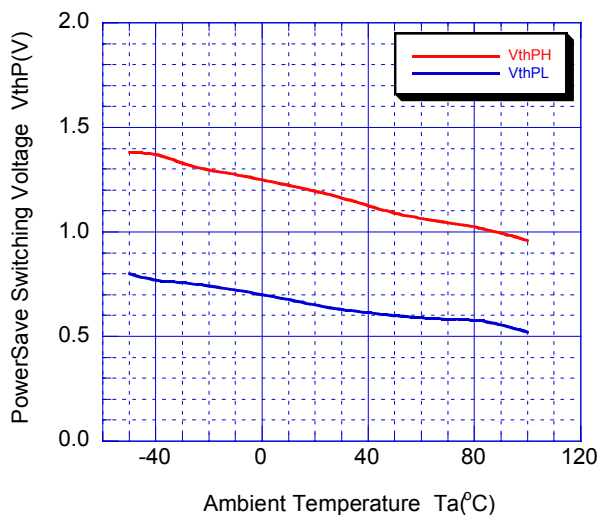

**[CAUTION]**

The specifications on this databook are only given for information, without any guarantee as regards either mistakes or omissions. The application circuits in this databook are described only to show representative usages of the product and not intended for the guarantee or permission of any right including the industrial rights.

## X-ON Electronics

Largest Supplier of Electrical and Electronic Components

*Click to view similar products for [Video ICs category](#):*

*Click to view products by [Nisshinbo manufacturer](#):*

Other Similar products are found below :

[M21328G-12](#) [TW2964-LA2-CR](#) [TW9903-FB](#) [TW9919-PE1-GR](#) [ADV8003KBCZ-7T](#) [PI3HDX511DZLEX](#) [M23428G-33](#)  
[PI7VD9008ABHFDE](#) [ADV7186BBCZ-TL](#) [ADV7186BBCZ-T-RL](#) [ADV8003KBCZ-7C](#) [PI3VDP411LSAZBEX](#) [PI3VDP411LSTZBEX](#)  
[M23145G-14](#) [PI3VDP411LSRZBEX](#) [PI3HDX511EZLSEX](#) [BH76912GU-E2](#) [CM5100-01CP](#) [TVP5160PNP](#) [TVP5151PBSR](#) [BA7603F-E2](#)  
[MU82645DES S LM6B](#) [BH76106HFV-TR](#) [BH76206HFV-TR](#) [ADV7179WBCPZ](#) [ADV7611BSWZ-P-RL](#) [ADV7180KCP32Z](#)  
[ADV7180WBCP32Z](#) [ADV7182WBCPZ](#) [ADV7280KCPZ](#) [ADV7280WBCPZ-M](#) [ADV7281WBCPZ-MA](#) [ADV7283WBCPZ](#) [ADV7283BCPZ](#)  
[ADV7282WBCPZ-M](#) [ADV7280KCPZ-M](#) [ADV7280WBCPZ](#) [ADV7180KCP32Z-RL](#) [ADV7282AWBCPZ](#) [ADV7182AWBCPZ](#)  
[AD723ARUZ](#) [ADV7611BSWZ](#) [ADV7181DWBCPZ-RL](#) [ADV7173KSTZ-REEL](#) [ADV7180WBST48Z-RL](#) [ADA4411-3ARQZ](#) [ADA4411-3ARQZ-R7](#) [ADA4417-3ARMZ](#) [ADA4417-3ARMZ-R7](#) [ADA4424-6ARUZ](#)