

SINGLE-SUPPLY DUAL OPERATIONAL AMPLIFIER

■ GENERAL DESCRIPTION

The NJM2904C / NJM2904CA consists of two independent, high gain, internally frequency compensated operation amplifiers, which were designed specifically to operate from a single power supply over a wide range of voltages. Operation from split power supplies is also possible and the low power supply current drain is independent of the magnitude of the power supply voltage.

Application areas include transducer amplifiers, DC gain blocks, and all the conventional op amp circuits, which now can be more easily implemented in single power supply systems. For example, the NJM2904C can be directly operated off of the standard +5V power supply voltage, which is used in digital systems and will easily provide the required interface electronics without requiring the additional $\pm 15V$ power supplies.

■ FEATURES

- Single Supply
- Operating Voltage +3V to +32V
- Low Operating Current 0.7mA typ.
- Slew Rate 0.6V/ μ s typ.
- Bipolar Technology
- Package Outline SOP8, DMP8, SSOP8, EQFN12-E2, MSOP8 (TVSP8) **MEET JEDEC MO-187-DA / THIN TYPE
- Internal ESD protection Human body model (HBM) $\pm 2000V$ typ.
- Wide temperature range -40°C to +125°C
- Input Offset Voltage Grade

NJM2904C(Normal-Grade)	NJM2904CA(A-Grade)
7mV max.	2mV max.

* NJM2904CME2 don't have a A version.

■ PACKAGE OUTLINE



NJM2904CG
NJM2904CAG
(SOP8)



NJM2904CM
NJM2904CAM
(DMP8)



NJM2904CRB1
NJM2904CARB1
(MSOP8(TVSP8))



NJM2904CV
NJM2904CAV
(SSOP8)



NJM2904CME2
(EQFN12-E2)

■ PIN CONFIGURATION

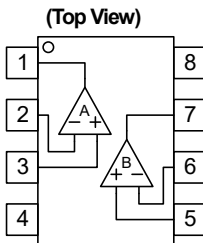

- PIN FUNCTION**
1. A OUTPUT
 2. A -INPUT
 3. A +INPUT
 4. V
 5. B + INPUT
 6. B - INPUT
 7. B OUTPUT
 8. V⁺

NJM2904CG/2904CAG
NJM2904CM/2904CAM
NJM2904CRB1/2904CARB1
NJM2904CV/2904CAV

(Top View)

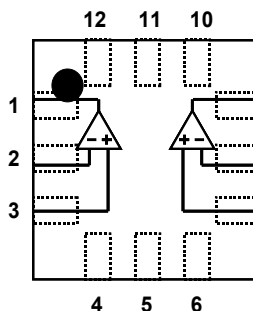

NJM2904CME2 (Note1, 2, 3)

(Bottom View)

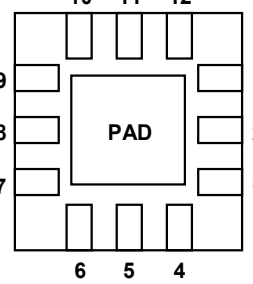

- PIN FUNCTION**
1. A OUTPUT
 2. A -INPUT
 3. A +INPUT
 4. NC
 5. V
 6. NC
 7. B +INPUT
 8. B -INPUT
 9. B OUTPUT
 10. NC
 11. V⁺
 12. NC

(Note1) The PAD have to be wired as short as possible to connect with a V⁺ terminal.

(Note2) The PAD is electronically connected to the backside of the die. But, there cannot be used as V⁻ pin.

(Note3) The NC pin is not internally connected.

■ EQUIVALENT CIRCUIT (1/2 Shown)

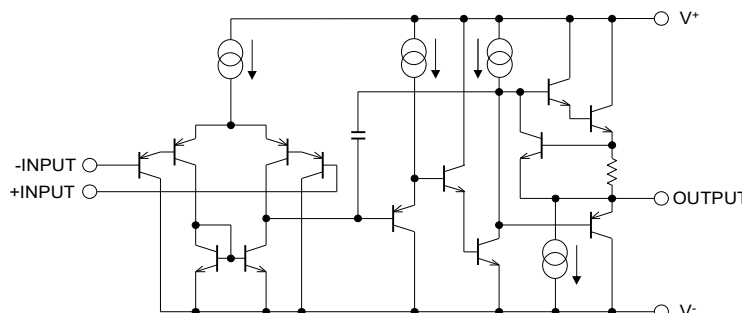

NJM2904C / NJM2904CA

■ ABSOLUTE MAXIMUM RATINGS

(Ta=25°C)

PARAMETER	SYMBOL	RATINGS	UNIT
Supply Voltage	$V^+ - V^-$	+32	V
Differential Input Voltage (Note4)	V_{ID}	±32	V
Input Voltage (Note5)	V_{IN}	$V^- - 0.3$ to $V^+ + 32$	V
Output Terminal Input Voltage	V_o	$V^- - 0.3$ to $V^+ + 0.3$	V
Power Dissipation	P_D	SOP : 690 (Note6) 1000(Note7) DMP : 470 (Note6) 600 (Note7) MSOP : 510 (Note6) 680 (Note7) SSOP : 430 (Note6) 540(Note7) EQFN : 440 (Note8) 680(Note9)	mW
Operating Temperature Range	T_{opr}	-40 to +125	°C
Storage Temperature Range	T_{stg}	-65 to +150	°C

(Note4) Differential voltage is the voltage difference between +INPUT and -INPUT.

(Note5) Input voltage is the voltage should be allowed to apply to the input terminal independent of the magnitude of V^+ .

The normal operation will establish when any input is within the Common Mode Input Voltage Range of electrical characteristics.

(Note6) EIA/JEDEC STANDARD Test board (76.2 x 114.3 x 1.6mm, 2layers, FR-4) mounting

(Note7) EIA/JEDEC STANDARD Test board (76.2 x 114.3 x 1.6mm, 4layers, FR-4) mounting

(Note8) EIA/JEDEC STANDARD Test board (101.5 x 114.3 x 1.6mm, 2layers, FR-4) mounting

(Note9) EIA/JEDEC STANDARD Test board (101.5 x 114.3 x 1.6mm, 4layers, FR-4) mounting

■ ELECTRICAL CHARACTERISTICS

($V^+=5V$, $V^-=0V$, $T_a=25^\circ C$, unless otherwise noted.)

PARAMETER	SYMBOL	TEST CONDITION	MIN.	TYP.	MAX.	UNIT
Supply Current (All amplifiers)	I_{SUPPLY}	$V^+=5V$, no signal $V^+=30V$, no signal	-	0.7	1.2	mA
Input Offset Voltage	V_{IO}	$R_S=0\Omega$ $R_S=0\Omega$, NJM2904CA	-	0.5	7	mV
Input Bias Current	I_B		-	20	150	nA
Input Offset Current	I_{IO}		-	2	30	nA
Open-Loop Voltage Gain	A_V	$R_L \geq 2k\Omega$	94	100	-	dB
Supply Voltage Rejection Ratio	SVR	$V^+=5$ to $30V$, $R_S < 10k\Omega$	65	100	-	dB
Common Mode Input Voltage Range	V_{ICM}	$V^+=30V$, $CMR > 70dB$	0	-	$V^+ - 1.5$	V
Common Mode Rejection Ratio	CMR	$R_S < 10k\Omega$	70	100	-	dB
Output Source Current	I_{SOURCE}	$V^+=15V$, $V_o = +2V$, $V_{IN+} = 1V$, $V_{IN-} = 0V$	20	40	-	mA
Output Sink Current	I_{SINK}	$V^+=15V$, $V_o = +2V$, $V_{IN+} = 0V$, $V_{IN-} = 1V$ $V^+=15V$, $V_o = +0.2V$, $V_{IN+} = 0V$, $V_{IN-} = 1V$	10 12	20 50	-	mA μA
High-level output voltage	V_{OH}	$R_L = 2k\Omega$, $V^+ = 30V$ $R_L = 10k\Omega$, $V^+ = 30V$	26 27	27 28	-	V
Low-level output voltage	V_{OL}	$R_L = 10k\Omega$	-	5	20	mV
Slew Rate	SR	$V^+ = 15V$, $V_{IN} = 0.5$ to $3V$, $C_L = 100pF$	-	0.6	-	V/ μs
Gain Band Width Product	GBW	$V^+ = 30V$, $f = 100kHz$, $V_{IN} = 10mV_{rms}$, $R_L = 2k\Omega$, $C_L = 100pF$	-	1.1	-	MHz
Total Harmonic Distortion + Noise	THD+N	$f = 1kHz$, $G_v = 20dB$, $R_L = 2k\Omega$, $V_o = 2V_{pp}$, $C_L = 100pF$	-	0.02	-	%
Equivalent input noise voltage	e_n	$f = 1kHz$, $R_S = 100\Omega$, $V^+ = 30V$	-	30	-	nV/ \sqrt{Hz}
Channel Separation	CS	$1kHz < f < 10kHz$	-	120	-	dB

TYPICAL CHARACTERISTICS

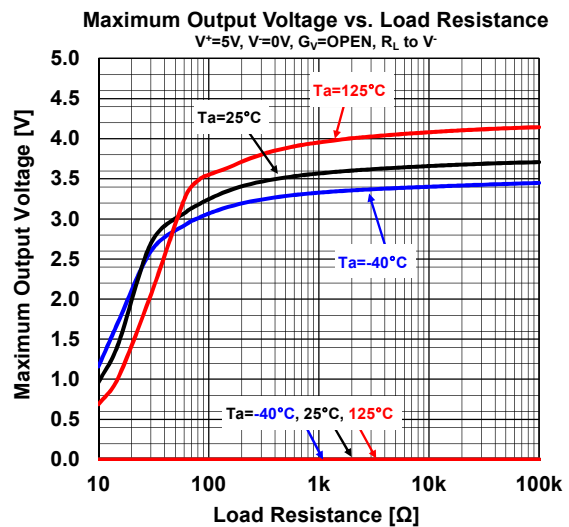
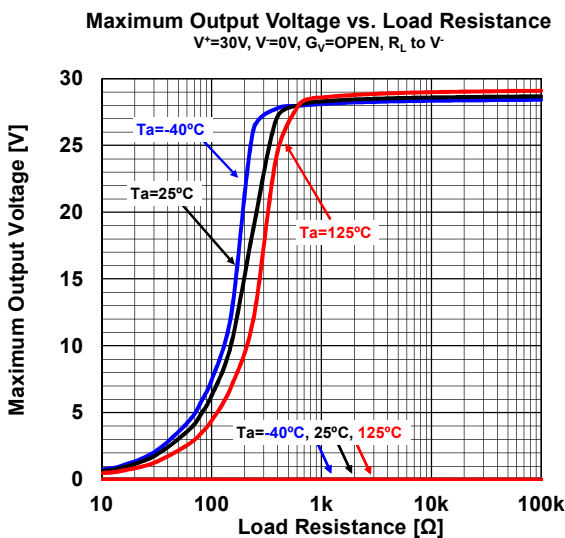
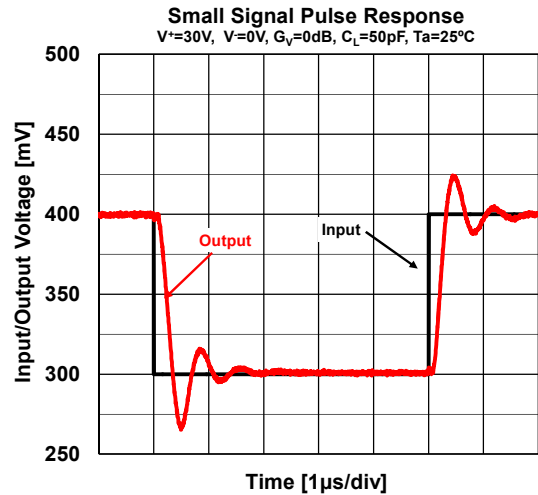
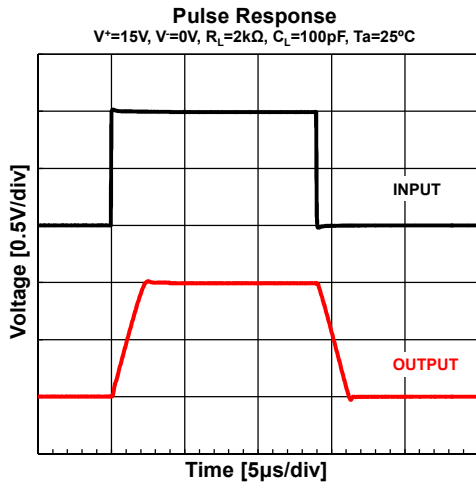
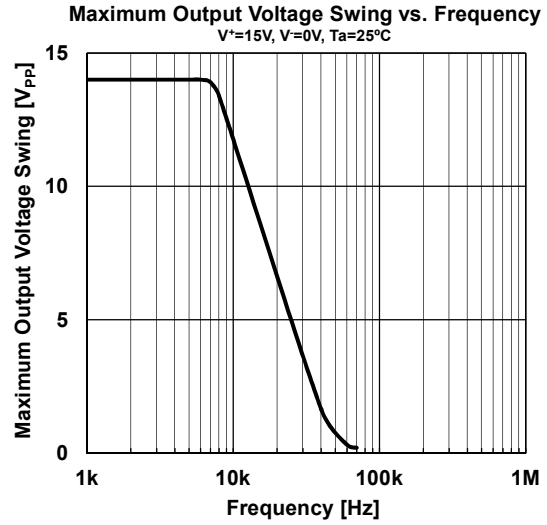
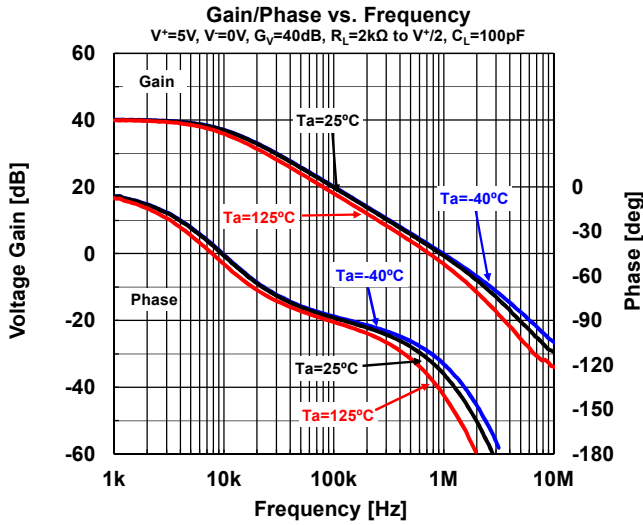

NJM2904C / NJM2904CA

■ TYPICAL CHARACTERISTICS

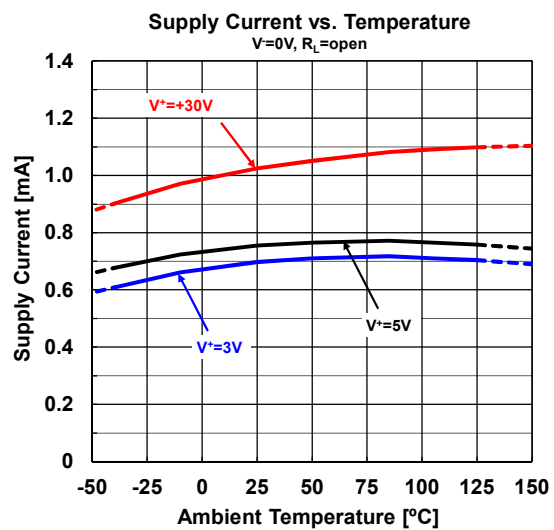
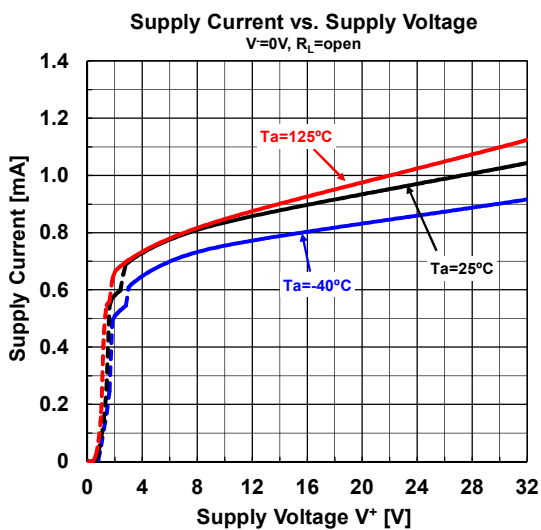
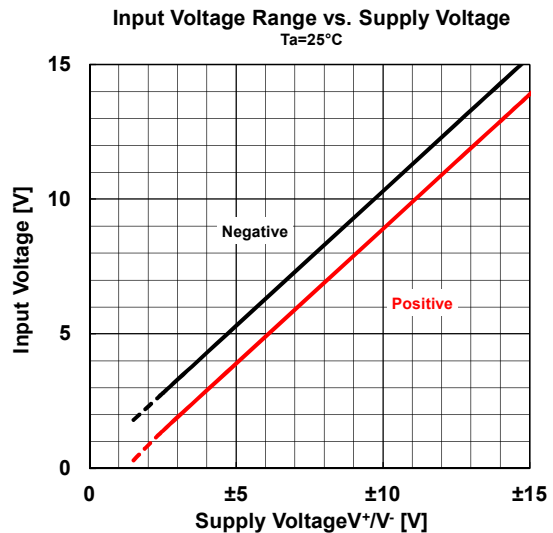
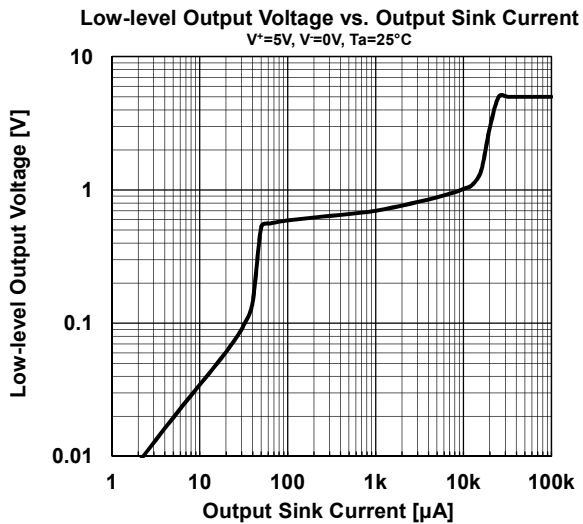
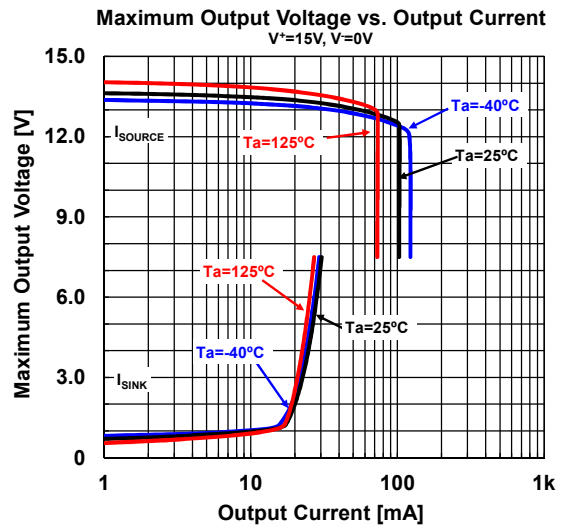
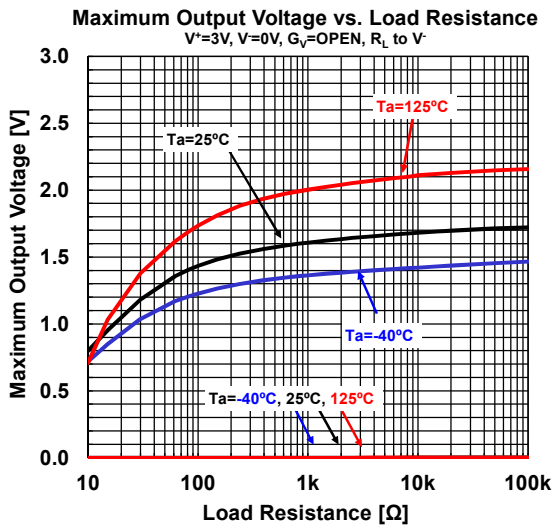

■ TYPICAL CHARACTERISTICS

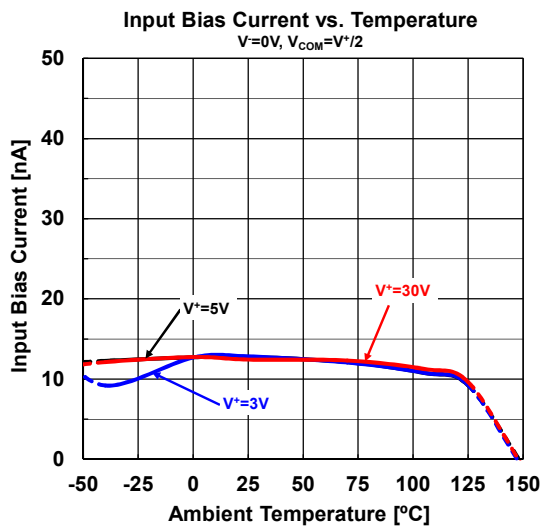
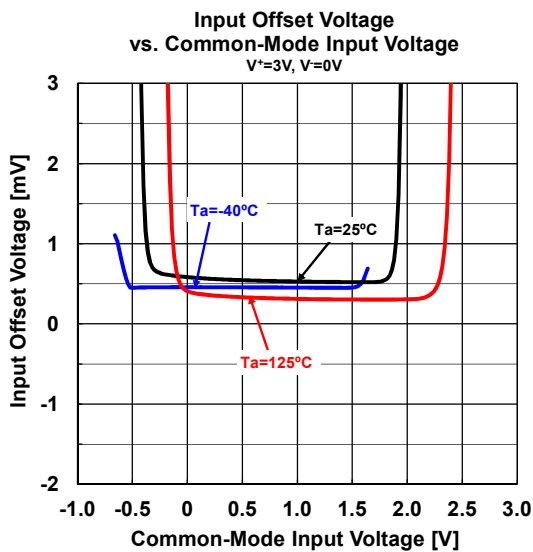
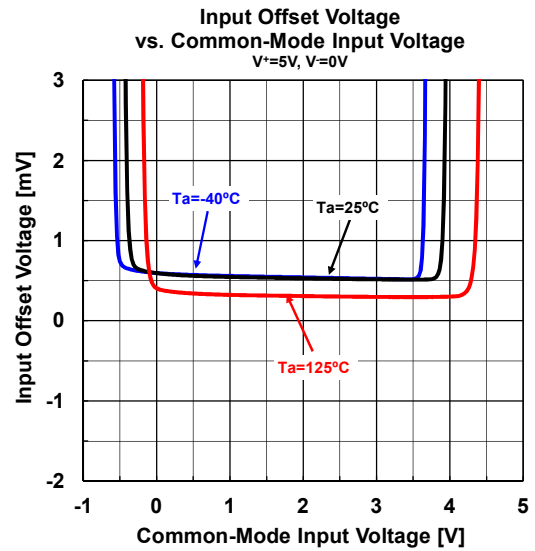
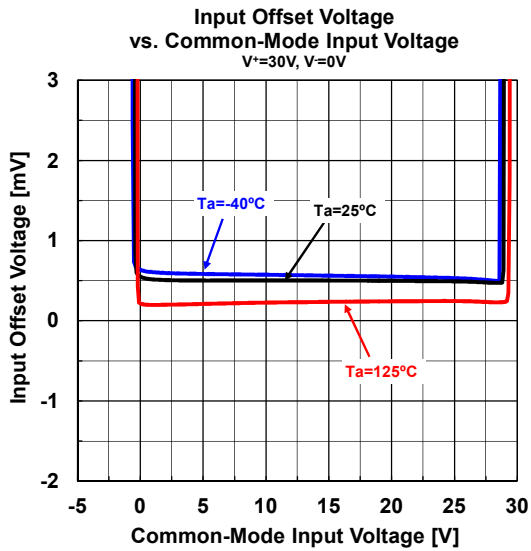
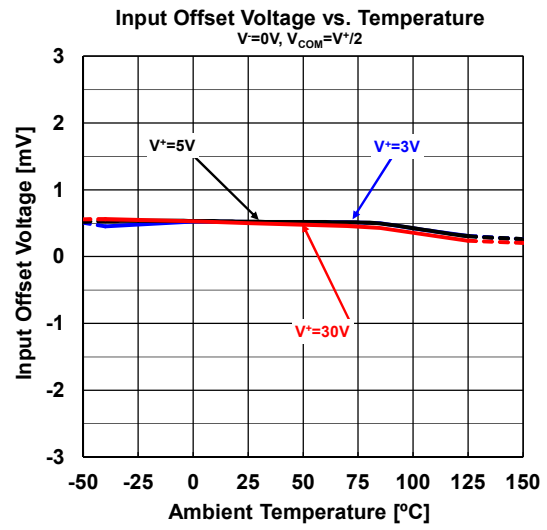
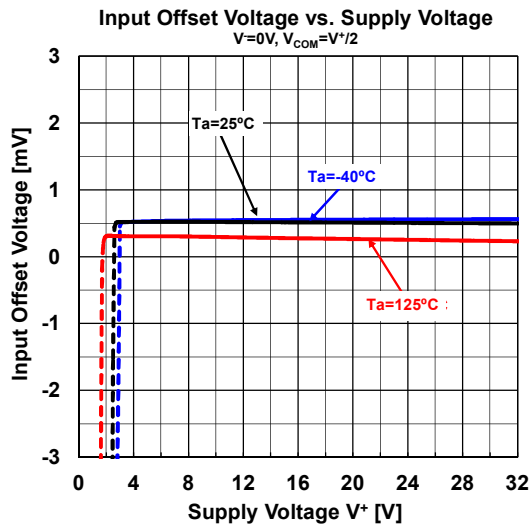

NJM2904C / NJM2904CA

■ TYPICAL CHARACTERISTICS

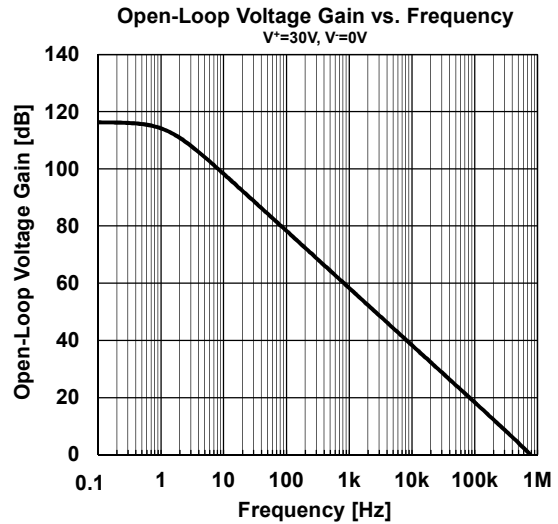
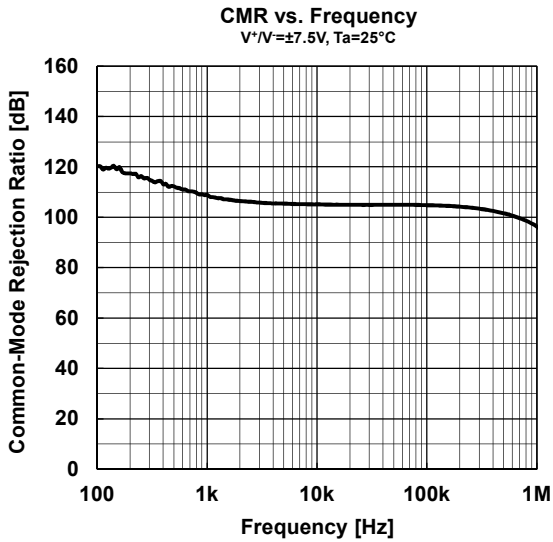
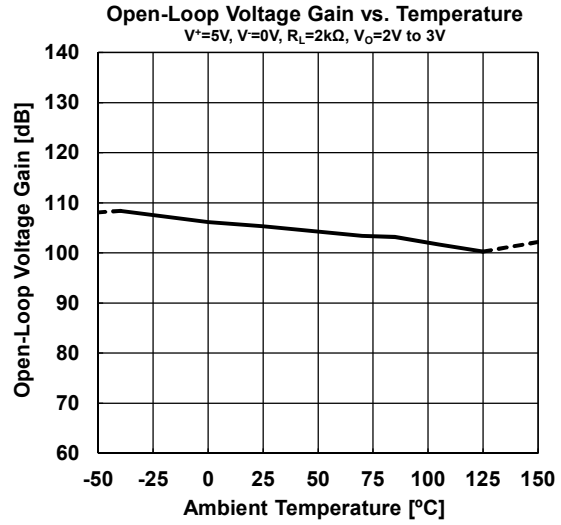
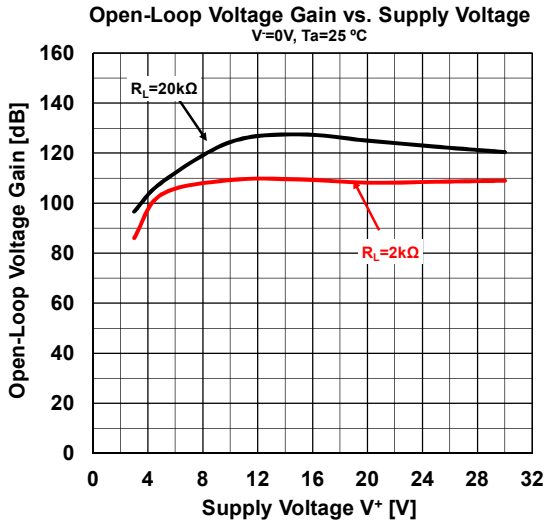

■ APPLICATION

Improvement of Cross-over Distortion
Equivalent circuit at the output stage

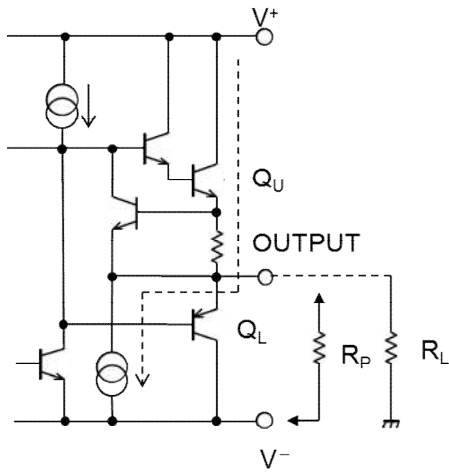

NJM2904C / NJM2904CA, in its static state (No in and output condition) when design, Q_U being biased by constant current (break down beam) yet, Q_L stays OFF.

While using with both power source mode, the cross-over distortion might occur instantly when Q_L ON.

There might be cases when application for amplifier of audio signals, not only distortion but also the apparent frequency bandwidth being narrowed remarkably.

It is adjustable especially when using both power source mode, constantly to use with higher current on Q_U than the load current (including feedback current), and then connect the pull-down resistor R_P at the part between output and V^- pins.

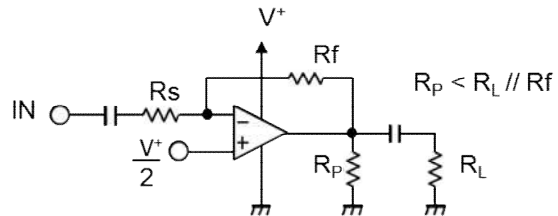
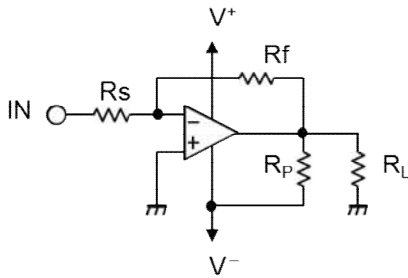

NJM2904C / NJM2904CA

■PACKAGE OUTLINE UNIT : mm

SOP8

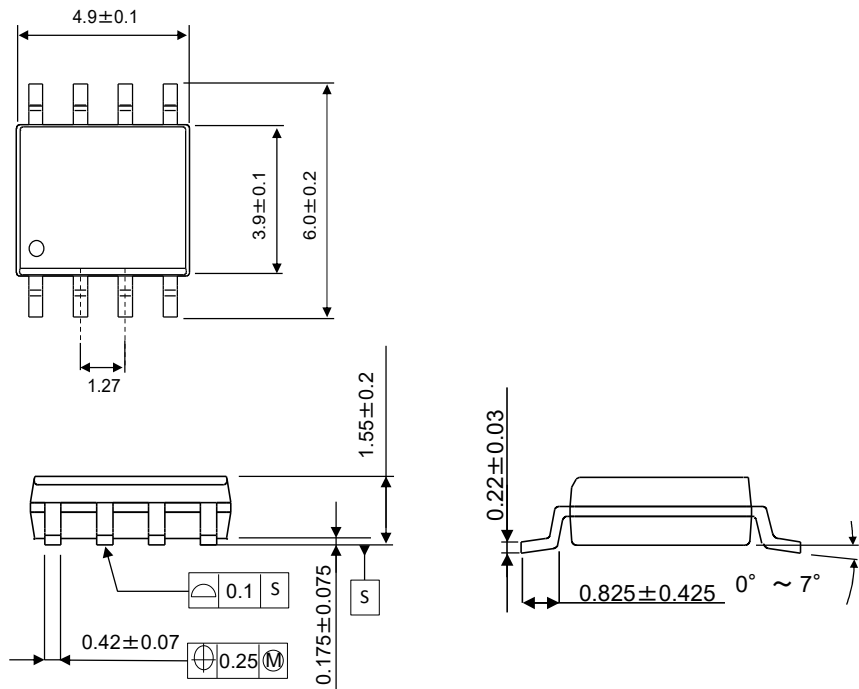

DMP8

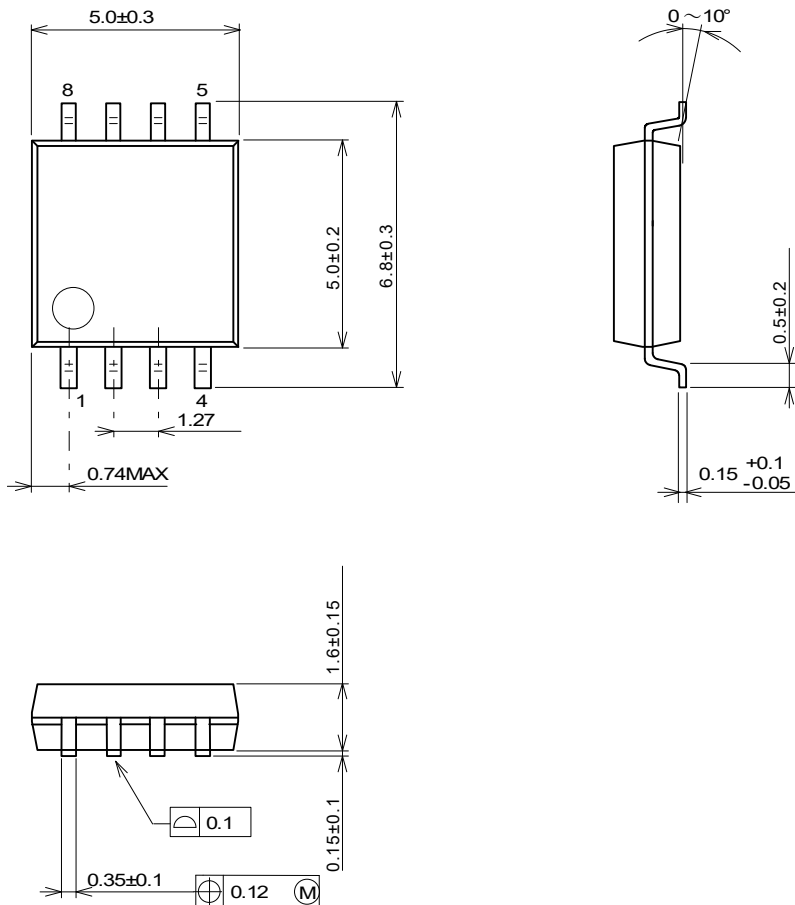

NJM2904C / NJM2904CA

■PACKAGE OUTLINE UNIT : mm

MSOP8 (TVSP8)*

*MEET JEDEC MO-187-DA / THIN TYPE

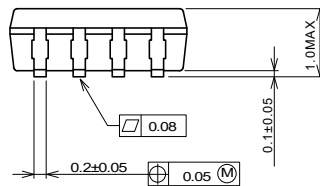
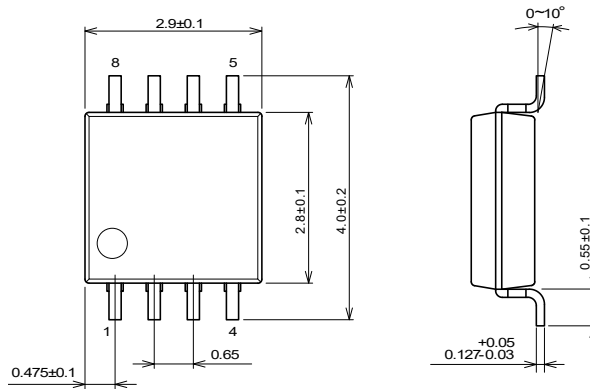

SSOP8

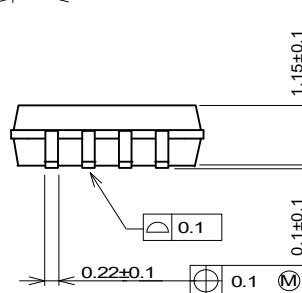
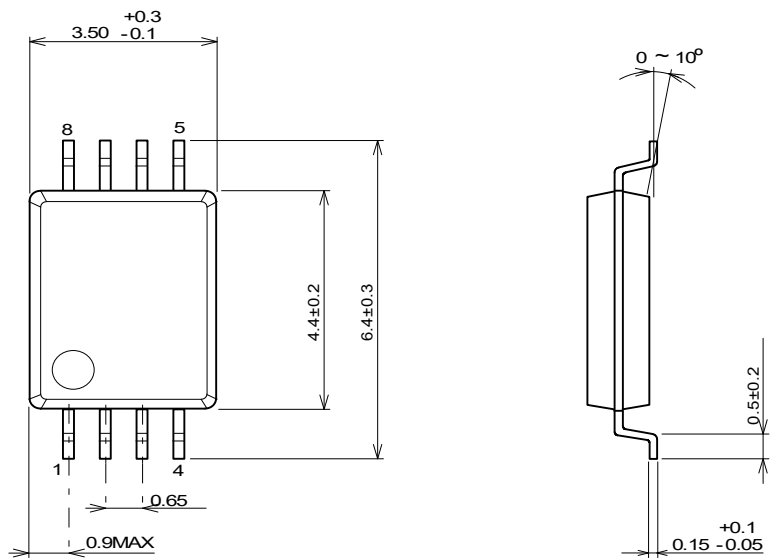

NJM2904C / NJM2904CA

■PACKAGE OUTLINE UNIT : mm
EQFN12-E2

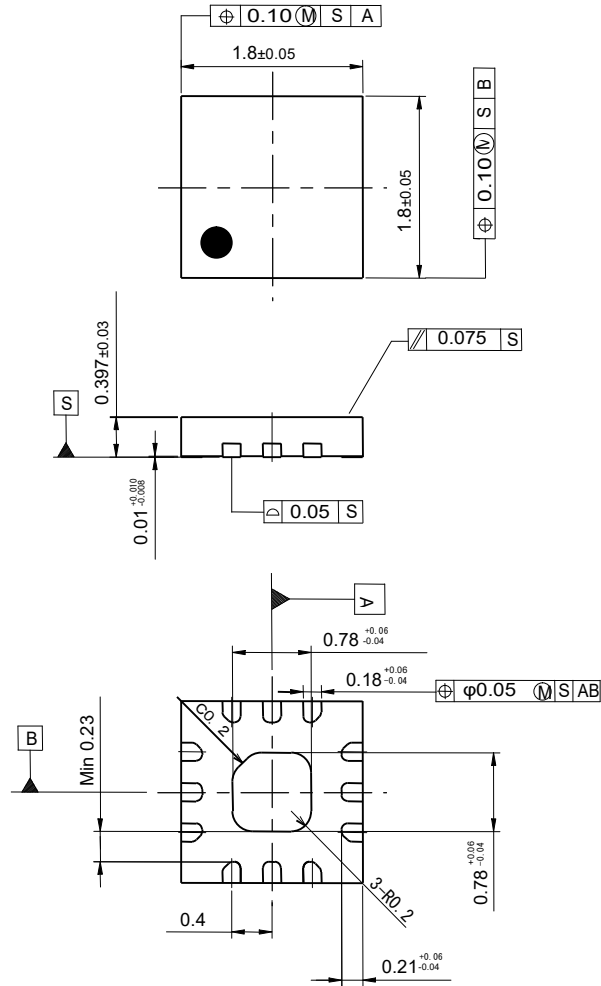

[CAUTION]
The specifications on this databook are only given for information, without any guarantee as regards either mistakes or omissions. The application circuits in this databook are described only to show representative usages of the product and not intended for the guarantee or permission of any right including the industrial rights.

X-ON Electronics

Largest Supplier of Electrical and Electronic Components

Click to view similar products for [Operational Amplifiers - Op Amps](#) category:

Click to view products by [Nisshinbo](#) manufacturer:

Other Similar products are found below :

[NCV33072ADR2G](#) [LM358SNG](#) [430227FB](#) [UPC824G2-A](#) [LT1678IS8](#) [042225DB](#) [058184EB](#) [UPC822G2-A](#) [UPC259G2-A](#) [UPC258G2-A](#)
[NTE925](#) [AZV358MTR-G1](#) [AP4310AUMTR-AG1](#) [HA1630D02MMEL-E](#) [HA1630S01LPEL-E](#) [SCY33178DR2G](#) [NJU77806F3-TE1](#)
[NCV5652MUTWG](#) [NCV20034DR2G](#) [LM324EDR2G](#) [LM2902EDR2G](#) [NTE7155](#) [NTE778S](#) [NTE871](#) [NTE924](#) [NTE937](#) [MCP6V17T-](#)
[E/MNY](#) [MCP6V19-E/ST](#) [MXD8011HF](#) [MCP6V17T-E/MS](#) [SCY6358ADR2G](#) [ADA4523-1BCPZ](#) [LTC2065HUD#PBF](#) [ADA4523-1BCPZ-](#)
[RL7](#) [NJM2904CRB1-TE1](#) [2SD965T-R](#) [RS6332PXK](#) [BDM8551](#) [BDM321](#) [MD1324](#) [COS8052SR](#) [COS8552SR](#) [COS8554SR](#) [COS2177SR](#)
[COS2353SR](#) [COS724TR](#) [ASOPD4580S-R](#) [RS321BKXF](#) [ADA4097-1HUIJZ-RL7](#) [NCS20282FCTTAG](#)