

## SINGLE-SUPPLY QUAD OPERATIONAL AMPLIFIER

### ■ GENERAL DESCRIPTION

The NJM3403A is high performance ground sensing quad operational amplifier featuring the high slew rate and no crossover distortion.

The NJM3403A is improved version of the NJM2902.

### ■ FEATURES

- Single Supply
- Operating Voltage ( +4V~+36V )
- Low Operating Current ( 3mA typ. )
- Slew Rate ( 1.2V/μs typ. )
- Package Outline DIP14,DMP14,SSOP14
- Bipolar Technology

### ■ PACKAGE OUTLINE

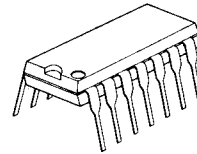

NJM3403AD

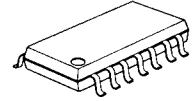

NJM3403AM

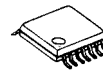

NJM3403AV

### ■ PIN CONFIGURATION

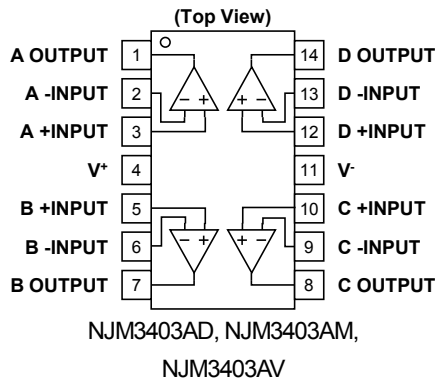

### ■ EQUIVALENT CIRCUIT ( 1/4 Shown )

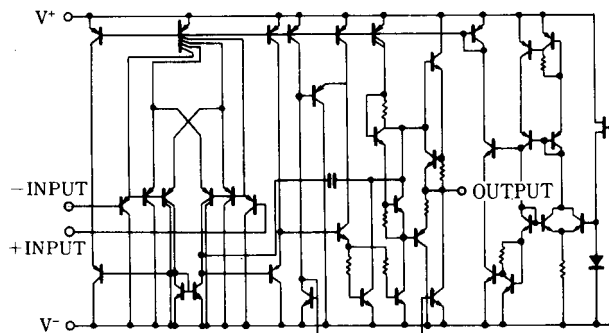

# NJM3403A

## ■ ABSOLUTE MAXIMUM RATINGS

(Ta=25°C)

PARAMETER	SYMBOL	RATINGS	UNIT
Supply Voltage	$V^+(V^-/V)$	36 ( or $\pm 18$ )	V
Differential Input Voltage	$V_{ID}$	36	V
Input Voltage	$V_{IC}$	-0.3~+36	V
Power Dissipation	$P_D$	( DIP14 ) 500 ( DMP14 ) 300 ( SSOP14 ) 300	mW
Operating Temperature Range	$T_{opr}$	-40~+85	°C
Storage Temperature Range	$T_{stg}$	-40~+125	°C

## ■ ELECTRICAL CHARACTERISTICS

(Ta=25°C,  $V^+/V^- = \pm 15V$ )

PARAMETER	SYMBOL	TEST CONDITION	MIN.	TYP.	MAX.	UNIT
Input Offset Voltage	$V_{IO}$	$R_S=0\Omega$	-	2	5	mV
Input Offset Current	$I_{IO}$		-	5	50	nA
Input Bias Current	$I_B$		-	70	200	nA
Large Signal Voltage Gain	$A_V$	$R_L > 2k\Omega$	88	100	-	dB
Maximum Output Voltage Swing	$V_{OM}$	$R_L = 2k\Omega$	$\pm 13$	$\pm 14$	-	V
Input Common Mode Voltage Range	$V_{ICM}$		-15~+13	-	-	V
Common Mode Rejection Ratio	CMR	DC	70	90	-	dB
Supply Voltage Rejection Ratio	SVR		80	94	-	dB
Output Source Current	$I_{SOURCE}$	$V_{IN}^+ = 1V, V_{IN}^- = 0V$	20	30	-	mA
Output Sink Current	$I_{SINK}$	$V_{IN}^+ = 0V, V_{IN}^- = 1V$	10	20	-	mA
Channel Separation	CS	$f=1k\sim 20kHz$ Input Referred	-	120	-	dB
Operating Current	$I_{CC}$	$R_L = \infty$	-	3	5	mA
Slew Rate	SR		-	1.2	-	V/ $\mu s$
Unity Gain Bandwidth	$f_T$		-	1.2	-	MHz
Total Harmonic Distortion	THD	$f=20kHz, V_O=10V_{PP}$	-	1	-	%

## ■ TYPICAL CHARACTERISTICS

### Open Loop Voltage Gain vs. Frequency

( $V^+/V^- = \pm 15V$ ,  $R_L = 2k\Omega$ ,  $T_a = 25^\circ C$ )

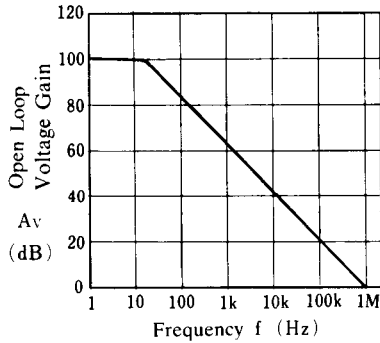

### Maximum Output Voltage Swing vs. Frequency

( $V^+/V^- = \pm 15V$ ,  $R_L = 2k\Omega$ ,  $T_a = 25^\circ C$ )

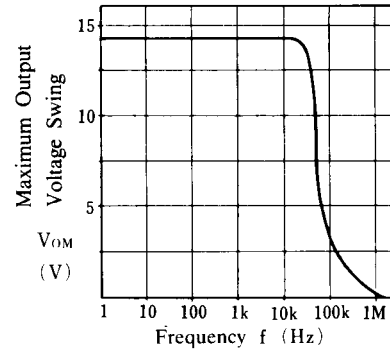

### Equivalent Input Noise Voltage vs. Frequency

( $V^+/V^- = 15V$ ,  $T_a = 25^\circ C$ )

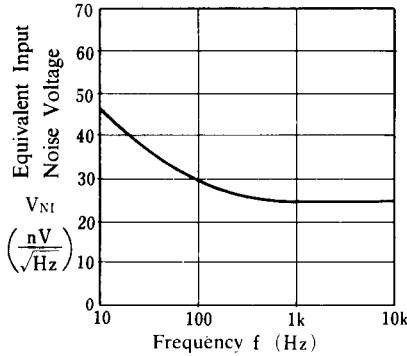

### Output Source Current vs. Output Voltage Swing

( $V^+/V^- = \pm 15V$ ,  $T_a = 25^\circ C$ )

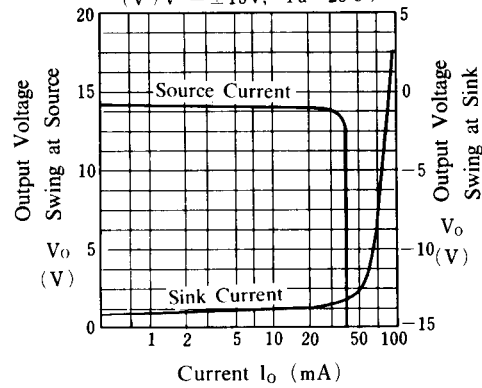

### Square Wave Respons

( $V^+/V^- = \pm 15V$ ,  $R_L = 2k\Omega$ ,  $A_v = 1$ ,  $T_a = 25^\circ C$ )

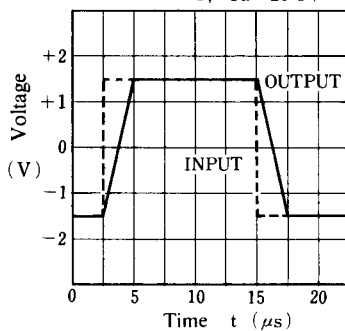

### Maximum Output Voltage vs. Load Resistance

( $V^+ = 5V$ ,  $T_a = 25^\circ C$ )

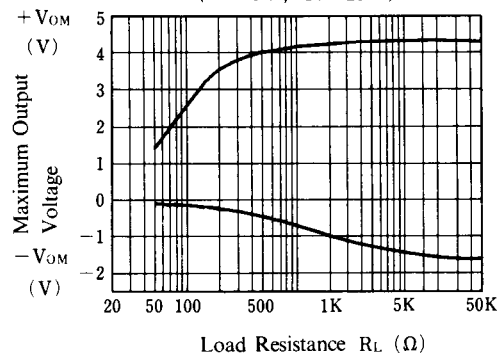

# NJM3403A

## ■ TYPICAL CHARACTERISTICS

**Input offset Voltage vs. Temperature**

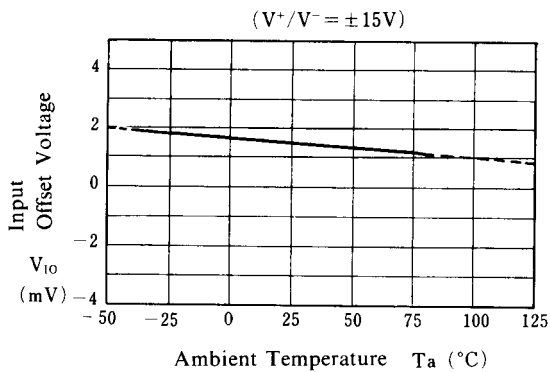

**Input Bias Current vs. Temperature**

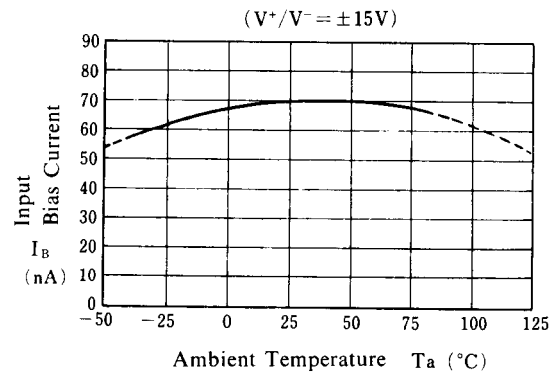

**Operating Current vs. Temperature**

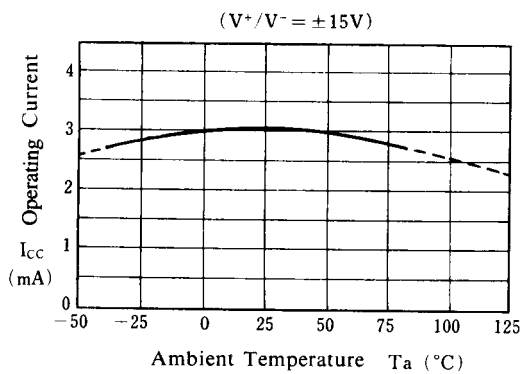

**Maximum Output Voltage Swing vs. Temperature**

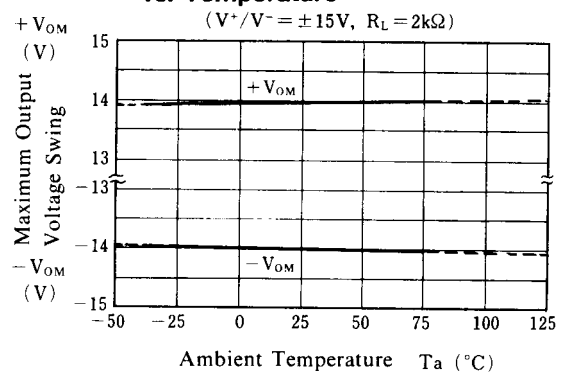

**Output Source Current vs. Temperature**

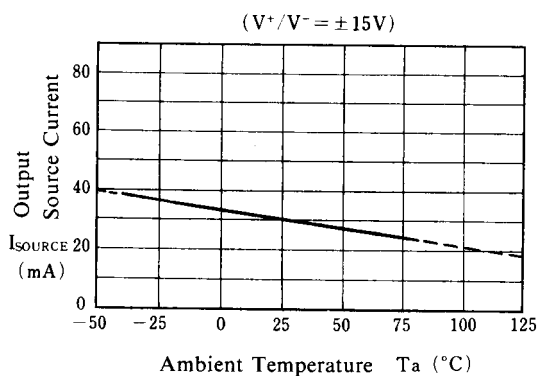

**Slew Rate vs. Temperature**

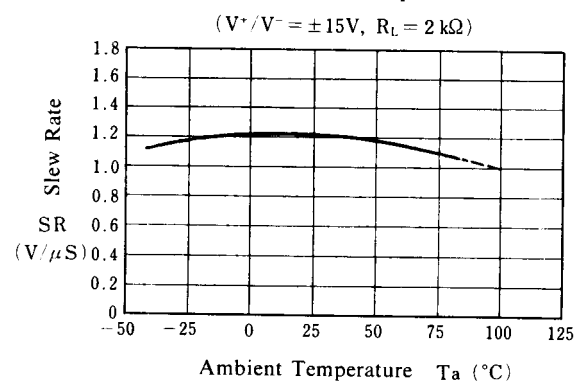

## ■ TYPICAL CHARACTERISTICS

**Operating Current vs. Operating Voltage**

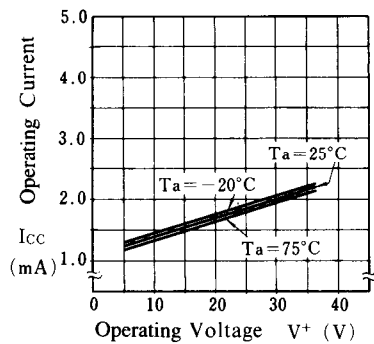

**Output Voltage Swing vs. Operating Voltage**

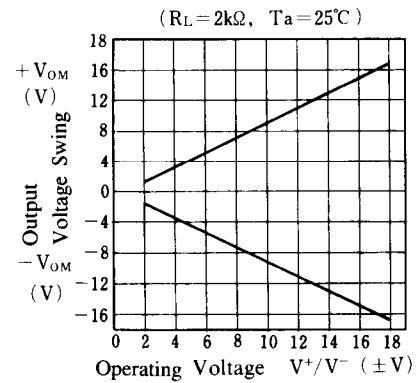

## ■ Crossover Distortion

Photos ( 1 ) and ( 2 ) show the output waveforms of NJM3403A and operational amplifier having crossover distortion. The NJM3403A eliminates the crossover distortion through the A,B class output stage as shown in the photo. NJM3403A IC has realized a wide band and a high slew rate in addition to the low distortion.

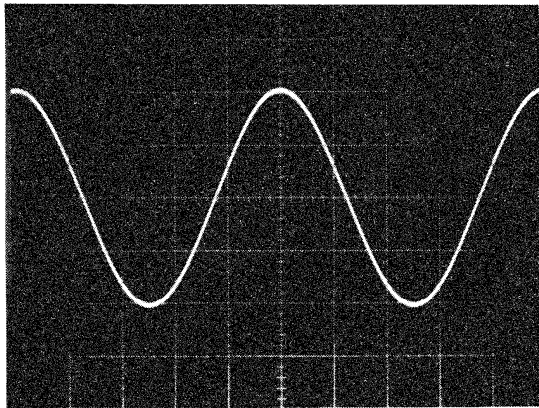

(1) NJM3403A Output Waveform

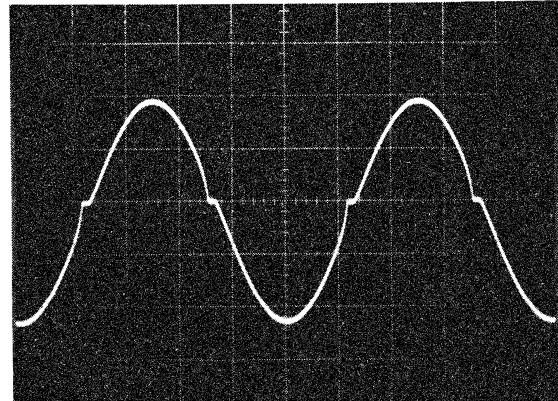

(2) Crossover Distortion Example

$f = 1\text{kHz}$ ,  $R_L = 2\text{k}\Omega$ , Vertical Axis:  $2\text{V/div}$

**[CAUTION]**

The specifications on this databook are only given for information, without any guarantee as regards either mistakes or omissions. The application circuits in this databook are described only to show representative usages of the product and not intended for the guarantee or permission of any right including the industrial rights.

## X-ON Electronics

Largest Supplier of Electrical and Electronic Components

*Click to view similar products for [Operational Amplifiers - Op Amps](#) category:*

*Click to view products by [Nisshinbo](#) manufacturer:*

Other Similar products are found below :

[NCV33072ADR2G](#) [LM358SNG](#) [430227FB](#) [UPC824G2-A](#) [LT1678IS8](#) [042225DB](#) [058184EB](#) [UPC822G2-A](#) [UPC259G2-A](#) [UPC258G2-A](#)  
[NTE925](#) [AZV358MTR-G1](#) [AP4310AUMTR-AG1](#) [HA1630D02MMEL-E](#) [HA1630S01LPEL-E](#) [SCY33178DR2G](#) [NJU77806F3-TE1](#)  
[NCV5652MUTWG](#) [NCV20034DR2G](#) [LM324EDR2G](#) [LM2902EDR2G](#) [NTE7155](#) [NTE778S](#) [NTE871](#) [NTE924](#) [NTE937](#) [MCP6V17T-](#)  
[E/MNY](#) [MCP6V19-E/ST](#) [MXD8011HF](#) [MCP6V17T-E/MS](#) [SCY6358ADR2G](#) [ADA4523-1BCPZ](#) [LTC2065HUD#PBF](#) [ADA4523-1BCPZ-](#)  
[RL7](#) [NJM2904CRB1-TE1](#) [2SD965T-R](#) [RS6332PXK](#) [BDM8551](#) [BDM321](#) [MD1324](#) [COS8052SR](#) [COS8552SR](#) [COS8554SR](#) [COS2177SR](#)  
[COS2353SR](#) [COS724TR](#) [ASOPD4580S-R](#) [RS321BKXF](#) [ADA4097-1HUIJZ-RL7](#) [NCS20282FCTTAG](#)