

## DUAL HIGH CURRENT OPERATIONAL AMPLIFIER

### ■ GENERAL DESCRIPTION

The NJM4556A integrated circuit is a high-gain, high output current dual operational amplifier capable of driving  $\pm 70\text{mA}$  into  $150\Omega$  loads ( $\pm 10.5\text{V}$  output voltage), and operating low supply voltage ( $V^+V^- = \pm 2\text{V} \sim$ ).

The NJM4556A combines many of the features of the popular NJM4558 as well as having the capability of driving  $150\Omega$  loads. In addition, the wide band-width, low noise, high slew rate and low distortion of the NJM4556A make it ideal for many audio, telecommunications and instrumentation applications.

### ■ FEATURES

- Supply Voltage ( $\pm 2\text{V} \sim \pm 18\text{V}$ )
- High Output Current ( $I_O = 70\text{mA}$ )
- Slew Rate ( $3\text{V}/\mu\text{s}$  typ.)
- Gain Band Width Product ( $8\text{MHz}$  typ.)
- Equivalent Input Noise Voltage ( $10\text{nV}/\sqrt{\text{Hz}}$  typ.)
- Package Outline DIP8, DMP8, SIP8, SSOP8
- Bipolar Technology

### ■ PACKAGE OUTLINE

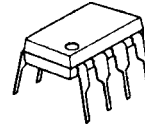

NJM4556AD



NJM4556AM



NJM4556AV

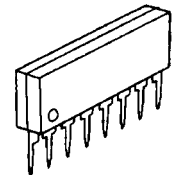

NJM4556AL

### ■ PIN CONFIGURATION

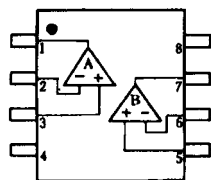

NJM4556AD  
NJM4556AM  
NJM4556AV

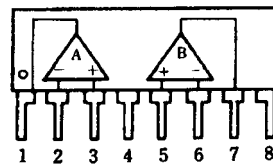

NJM4556AL

- PIN FUNCTION**
- 1. A OUTPUT
  - 2. A -INPUT
  - 3. A +INPUT
  - 4.  $V^-$
  - 5. B +INPUT
  - 6. B -INPUT
  - 7. B OUTPUT
  - 8.  $V^+$

### ■ EQUIVALENT CIRCUIT (1/2 Shown)

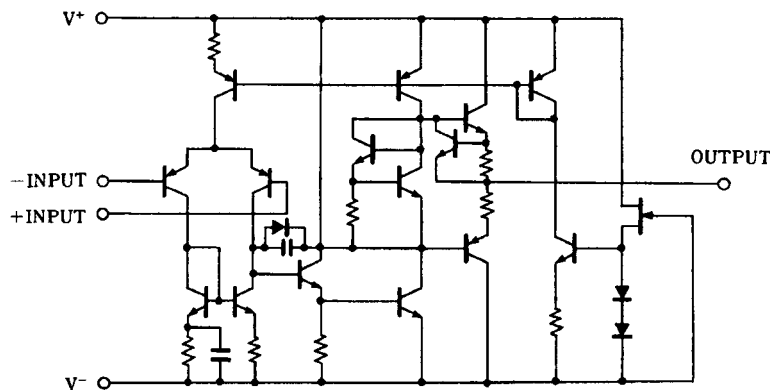

# NJM4556A

## ■ ABSOLUTE MAXIMUM RATINGS

(Ta=25°C)

PARAMETER	SYMBOL	RATINGS	UNIT
Supply Voltage	V <sup>+</sup> /V <sup>-</sup>	± 18	V
Differential Input Voltage	V <sub>ID</sub>	± 30	V
Input Voltage	V <sub>IC</sub>	± 15 (note)	V
Power Dissipation	P <sub>D</sub>	(DIP8) 700 (DMP8) 300 (SSOP8) 250 (SIP8) 800	mW
Operating Temperature Range	T <sub>opr</sub>	-40~+85	°C
Storage Temperature Range	T <sub>stg</sub>	-40~+125	°C

(note) For supply voltage less than ±15V, the absolute maximum input voltage is equal to the supply voltage.

## ■ ELECTRICAL CHARACTERISTICS (NJM4556AD / NJM4556AL)

(V<sup>+</sup>/V<sup>-</sup>=±15V, Ta=25°C)

PARAMETER	SYMBOL	TEST CONDITION	MIN.	TYP.	MAX.	UNIT
Input Offset Voltage	V <sub>IO</sub>	R <sub>S</sub> ≤10kΩ	-	0.5	6.0	mV
Input Offset Current	I <sub>IO</sub>		-	5	60	nA
Input Bias Current	I <sub>B</sub>		-	50	500	nA
Input Resistance	R <sub>IN</sub>		0.3	5	-	MΩ
Large Signal Voltage Gain	A <sub>V</sub>	R <sub>L</sub> ≥2kΩ, V <sub>O</sub> =±10V	86	100	-	dB
Maximum Output Voltage Swing 1	V <sub>OM1</sub>	R <sub>L</sub> ≥2kΩ	± 12	± 13.5	-	V
Maximum Output Voltage Swing 2	V <sub>OM2</sub>	R <sub>L</sub> ≥150Ω	± 10.5	± 11	-	V
Input Common Mode Voltage Range	V <sub>ICM</sub>		± 13.5	± 14	-	V
Common Mode Rejection Ratio	CMR	R <sub>S</sub> ≤10kΩ	70	90	-	dB
Supply Voltage Rejection Ratio	SVR	R <sub>S</sub> ≤10kΩ	76.5	90	-	dB
Supply Current	I <sub>CC</sub>		-	9	12	mA
Slew Rate	SR		-	3	-	V/μs
Gain Bandwidth Product	GB		-	8	-	MHz

## ■ ELECTRICAL CHARACTERISTICS (NJM4556AM / NJM4556AV)

(V<sup>+</sup>/V<sup>-</sup>=±15V, Ta=25°C)

PARAMETER	SYMBOL	TEST CONDITION	MIN.	TYP.	MAX.	UNIT
Input Offset Voltage	V <sub>IO</sub>	R <sub>S</sub> ≤10kΩ	-	0.5	6.0	mV
Input Offset Current	I <sub>IO</sub>		-	5	60	nA
Input Bias Current	I <sub>B</sub>		-	50	500	nA
Large Signal Voltage Gain	A <sub>V</sub>	R <sub>L</sub> ≥2kΩ, V <sub>O</sub> =±10V	86	100	-	dB
Maximum Output Voltage Swing 1	V <sub>OM1</sub>	V <sub>IN</sub> <sup>+</sup> =4V, V <sub>IN</sub> <sup>-</sup> =3V, V <sup>+</sup> =9V, V <sup>-</sup> =0V I <sub>SOURCE</sub> =40mA	7.5	-	-	V
Maximum Output Voltage Swing 2	V <sub>OM2</sub>	V <sub>IN</sub> <sup>+</sup> =3V, V <sub>IN</sub> <sup>-</sup> =4V, V <sup>+</sup> =9V, V <sup>-</sup> =0V I <sub>SINK</sub> =40mA	-	-	2.1	V
Input Common Mode Voltage Range 1	V <sub>ICM1</sub>	V <sup>+</sup> =9V, V <sup>-</sup> =0V, V <sub>IL</sub>	-	-	1.5	V
Input Common Mode Voltage Range 2	V <sub>ICM2</sub>	V <sup>+</sup> =9V, V <sup>-</sup> =0V, V <sub>IH</sub>	8	-	-	V
Common Mode Rejection Ratio	CMR	R <sub>S</sub> ≤10kΩ	70	90	-	dB
Supply Voltage Rejection Ratio	SVR	R <sub>S</sub> ≤10kΩ	76.5	90	-	dB
Supply Current	I <sub>CC</sub>	V <sup>+</sup> =9V, V <sup>-</sup> =0V	-	8	12	mA
Slew Rate	SR		-	3	-	V/μs
Gain Bandwidth Product	GB		-	8	-	MHz

## ■ TYPICAL CHARACTERISTICS

**Maximum Output Voltage Swing vs. Frequency**

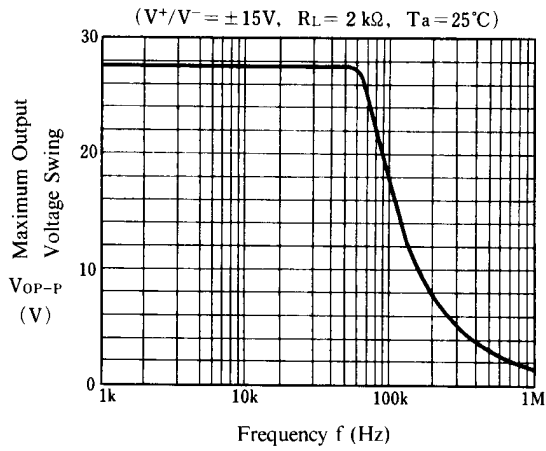

**Maximum Output Voltage Swing vs. Frequency**

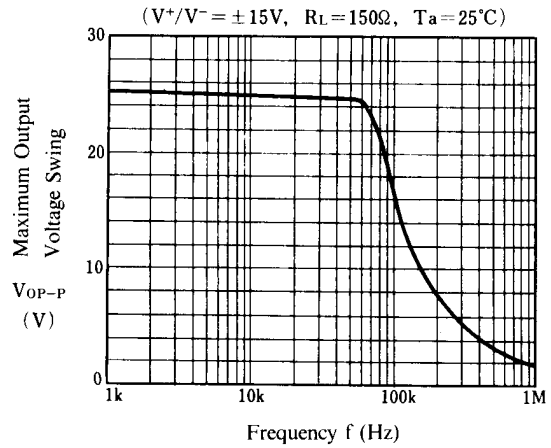

**Maximum Output Voltage Swing vs. Output Current**

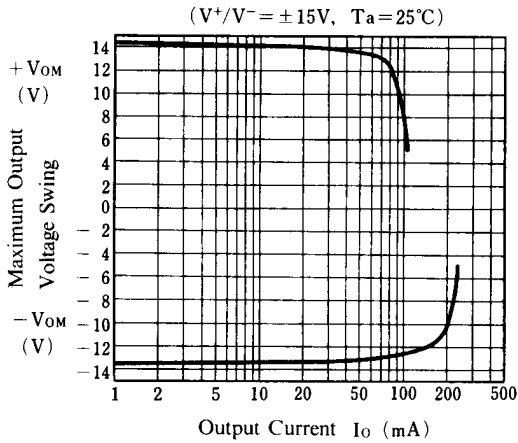

**Voltage Gain, Phase Shift vs. Frequency**

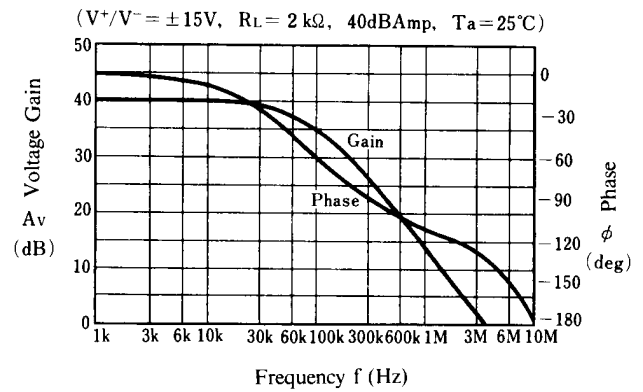

**Maximum Output Voltage Swing vs. Supply Voltage**

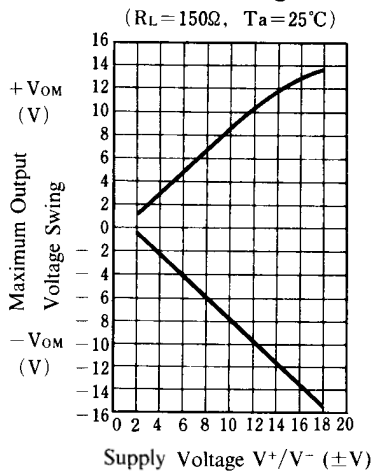

**Total Harmonic Distortion vs. Output Voltage**

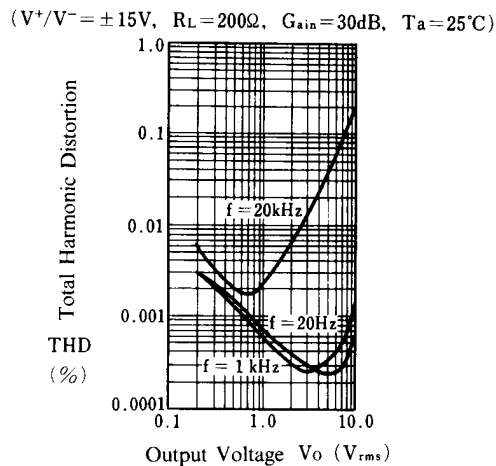

## ■ TYPICAL CHARACTERISTICS

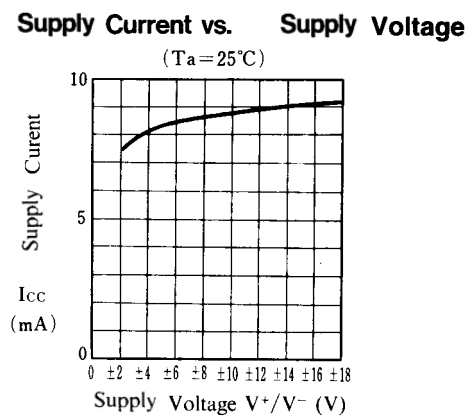
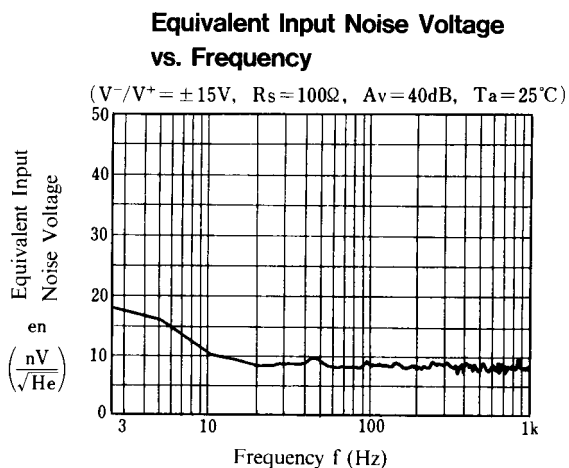
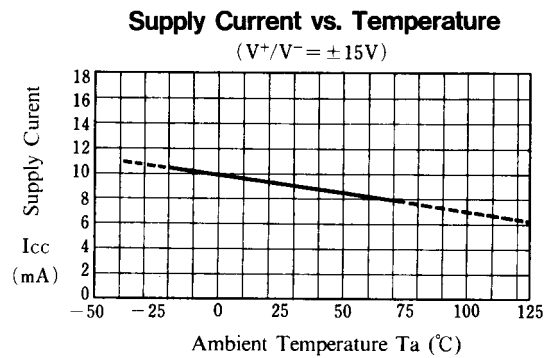
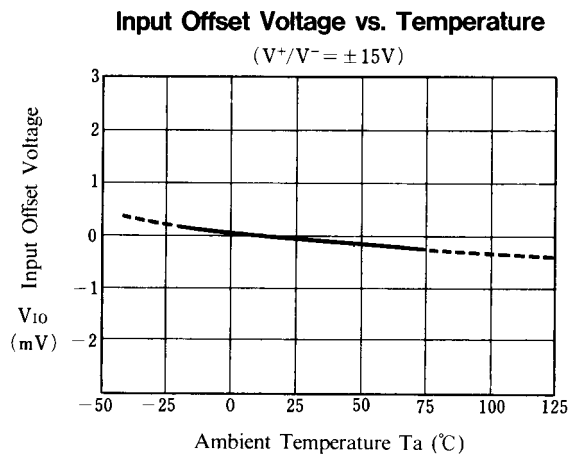
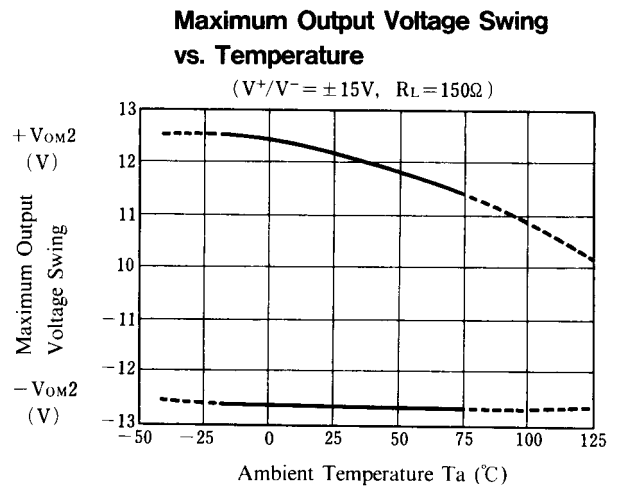
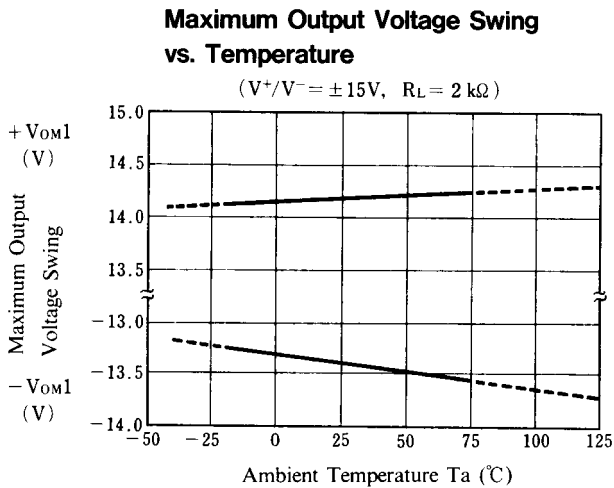

**[CAUTION]**  
The specifications on this databook are only given for information, without any guarantee as regards either mistakes or omissions. The application circuits in this databook are described only to show representative usages of the product and not intended for the guarantee or permission of any right including the industrial rights.

## X-ON Electronics

Largest Supplier of Electrical and Electronic Components

*Click to view similar products for [Operational Amplifiers - Op Amps](#) category:*

*Click to view products by [Nisshinbo](#) manufacturer:*

Other Similar products are found below :

[NCV33072ADR2G](#) [LM358SNG](#) [430227FB](#) [UPC824G2-A](#) [LT1678IS8](#) [042225DB](#) [058184EB](#) [UPC822G2-A](#) [UPC259G2-A](#) [UPC258G2-A](#)  
[NTE925](#) [AZV358MTR-G1](#) [AP4310AUMTR-AG1](#) [HA1630D02MMEL-E](#) [HA1630S01LPEL-E](#) [SCY33178DR2G](#) [NJU77806F3-TE1](#)  
[NCV5652MUTWG](#) [NCV20034DR2G](#) [LM324EDR2G](#) [LM2902EDR2G](#) [NTE7155](#) [NTE778S](#) [NTE871](#) [NTE924](#) [NTE937](#) [MCP6V17T-](#)  
[E/MNY](#) [MCP6V19-E/ST](#) [MXD8011HF](#) [MCP6V17T-E/MS](#) [SCY6358ADR2G](#) [ADA4523-1BCPZ](#) [LTC2065HUD#PBF](#) [ADA4523-1BCPZ-](#)  
[RL7](#) [NJM2904CRB1-TE1](#) [2SD965T-R](#) [RS6332PXK](#) [BDM8551](#) [BDM321](#) [MD1324](#) [COS8052SR](#) [COS8552SR](#) [COS8554SR](#) [COS2177SR](#)  
[COS2353SR](#) [COS724TR](#) [ASOPD4580S-R](#) [RS321BKXF](#) [ADA4097-1HUIJZ-RL7](#) [NCS20282FCTTAG](#)