

## 20V/μs, 10nV/√Hz, JFET Input Operational Amplifier

### ■ FEATURES ( $V^+ / V^- = \pm 15V$ , Typical value)

- High Slew Rate 20V/μs
- Low Noise 10nV/√Hz
- Low Distortion 0.0004%
- Gain Bandwidth 7MHz
- Supply Current at All Amplifiers 2.6mA
- High EMI Immunity EMIRR = 82dB (f = 1.8GHz)
- No Phase Reversal over Input Voltage Range
- Output Voltage close to  $V^-$  Supply.
  - $R_L = 2k\Omega$  -14.8V to 14.1V
  - $R_L = 600\Omega$  -14.3V to 13.9V
- Common-Mode Input Voltage range -12.5V to 12.5V
- Supply Voltage  $\pm 4V$  to  $\pm 16V$
- Unity-Gain Stable
- Package SOP8 (EMP8)

### ■ APPLICATIONS

- Sensor Amplifiers
- Amplifier for musical instruments
- Photodiode amplifier
- Active Filters

### ■ DESCRIPTION

NJM8087 is a JFET-Input high speed, low noise, low distortion operational amplifier achieved for high speed and high voltage applications.

The features of 20V/μs slew rate, 10nV/√Hz noise, 0.0004% THD+N, 25pA input bias current and 2.6mA low supply current, make the NJM8087 ideal for various high performance applications.

NJM8087 operates dual supply range of  $\pm 4$  to  $\pm 16V$  or single supply range of 8V to 32V. NJM8087 is unity gain stable for capacitive loads of 1000pF, and no phase reversal over input voltage which is up to supply range beyond the common mode range. Furthermore, low saturation output allows increasing dynamic range.

NJM8087 has high EMI immunity that can reduced malfunctions caused by Rf-noises from mobile phones and other electronic devices. This device operates from  $-40^\circ C$  to  $125^\circ C$ , available in SOP8 (EMP8) package.

### ■ TYPICAL CHARACTERISTICS

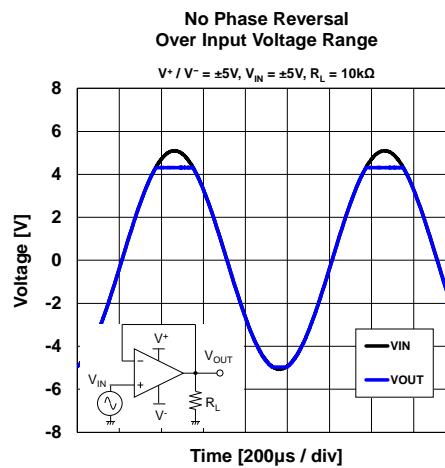
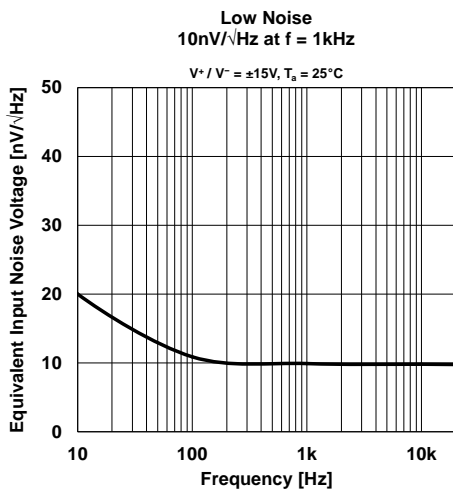

## ■ PIN CONFIGURATION

PRODUCT NAME	NJM8087E
Package	SOP8 (EMP8)
Pin Functions	<p>(Top View)</p> <p>A OUTPUT 1      8 V+</p> <p>A -INPUT 2      7 B OUTPUT</p> <p>A +INPUT 3      6 B -INPUT</p> <p>V- 4      5 B +INPUT</p>

## ■ PRODUCT NAME INFORMATION

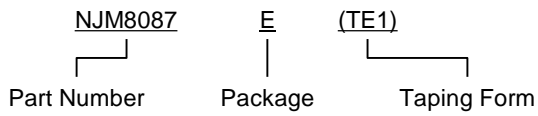

## ■ ORDERING INFORMATION

PRODUCT NAME	PACKAGE	RoHS	HALOGEN-FREE	TERMINAL FINISH	MARKING	WEIGHT (mg)	MOQ (pcs)
NJM8087E (TE1)	SOP8 (EMP8)	Yes	Yes	Sn2Bi	8087	76	2000

## ■ BLOCK DIAGRAM

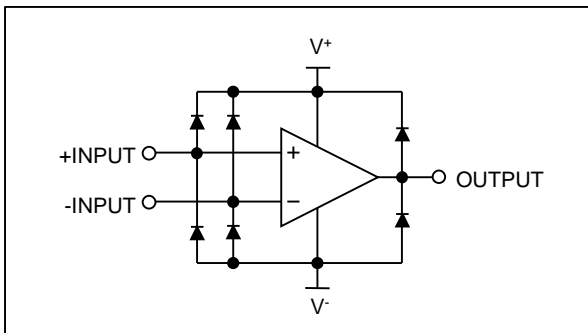

**■ ABSOLUTE MAXIMUM RATINGS**

PARAMETER	SYMBOL	RATING	UNIT
Supply Voltage	$V^+ / V^-$	$\pm 18$	V
Input Voltage <sup>(1)</sup>	$V_{IN}$	$V^- - 0.3$ to $V^+ + 0.3$	V
Input Current <sup>(1)</sup>	$I_{IN}$	10	mA
Differential Input Voltage <sup>(2)</sup>	$V_{ID}$	$\pm 36$	V
Output Short-Circuit Duration		Continuous ( $T_a \leq 25^\circ\text{C}$ )	
Power Dissipation ( $T_a = 25^\circ\text{C}$ ) SOP8 (EMP8)	$P_D$	2-Layer / 4-Layer <sup>(3)</sup> 700 / 1000	mW
Storage Temperature	$T_{stg}$	-65 to 150	$^\circ\text{C}$
Junction Temperature	$T_j$	150	$^\circ\text{C}$

(1) Input voltages outside the supply voltage will be clamped by ESD protection diodes. If the input voltage exceeds the supply voltage, the current must be limited 10 mA or less by using a restriction resistance.

The normal operation will establish when any input is within the "Common-Mode Input Voltage Range" of electrical characteristics.

(2) Differential voltage is the voltage difference between +INPUT and -INPUT.

(3) 2-Layer: Mounted on glass epoxy board (76.2 mm x 114.3 mm x 1.6 mm: based on EIA/JEDEC standard, 2-layer FR-4).

4-Layer: Mounted on glass epoxy board (76.2 mm x 114.3 mm x 1.6 mm: based on EIA/JEDEC standard, 4-layer FR-4), internal Cu area: 74.2 mm x 74.2 mm.

**■ RECOMMENDED OPERATING CONDITIONS**

PARAMETER	SYMBOL	CONDITIONS	VALUE	UNIT
Supply Voltage	$V^+ / V^-$	$T_a = 25^\circ\text{C}$	$\pm 4$ to $\pm 16$	V
Operating Temperature	$T_{opr}$		-40 to 125	$^\circ\text{C}$

**■ ELECTRICAL CHARACTERISTICS**

 ( $V^+ / V^- = \pm 15V$ ,  $V_{COM} = 0V$ ,  $R_L = 2k\Omega$ ,  $T_a = 25^\circ C$ , unless otherwise noted.)

PARAMETER	SYMBOL	TEST CONDITIONS	MIN	TYP	MAX	UNIT
<b>INPUT CHARACTERISTICS</b>						
Input Offset Voltage	$V_{IO}$		-	0.1	0.8	mV
Input Bias Current	$I_B$		-	25	80	pA
Input Offset Current	$I_{IO}$		-	6	75	pA
Input Offset Voltage Drift	$\Delta V_{IO}/\Delta T$	$T_a = -40^\circ C$ to $125^\circ C$	-	1	-	$\mu V/^\circ C$
Input Capacitance	$C_{IN}$		-	10	-	pF
Open-Loop Voltage Gain	$A_V$	$R_L = 2k\Omega$ , $V_O = -13.5V$ to $13.5V$	90	100	-	dB
Common-Mode Rejection Ratio	CMR	$V_{ICM} = -12.5V$ to $12.5V$	86	108	-	dB
Common-Mode Input Voltage Range	$V_{ICM}$	CMR $\geq 86$ dB	-12.5	-	12.5	V
<b>OUTPUT CHARACTERISTICS</b>						
High-level Output Voltage	$V_{OH}$	$R_L = 2k\Omega$	13.8	14.1	-	V
		$R_L = 600\Omega$	13.5	13.9	-	V
Low-level Output Voltage	$V_{OL}$	$R_L = 2k\Omega$	-	-14.8	-14.4	V
		$R_L = 600\Omega$	-	-14.3	-13.8	V
Output Short-Circuit Current	$I_{SC}$	Sourcing, $V_O = 0V$	-	62	-	mA
		Sinking, $V_O = 0V$	-	50	-	mA
<b>POWER SUPPLY</b>						
Supply Current (All Amplifiers)	$I_{SUPPLY}$	No Signal	-	2.6	3.0	mA
Supply Voltage Rejection Ratio	SVR	$V^+ / V^- = \pm 4V$ to $\pm 16V$	86	110	-	dB
<b>AC CHARACTERISTICS</b>						
Slew Rate	SR	Gain = 1, $V_{IN} = 2V_{PP}$	-	20	-	V/ $\mu s$
Unity Gain Frequency	$f_T$	$C_L = 10pF$	-	7	-	MHz
Settling Time	$t_s$	0.1%, 10V step, Gain = 1	-	0.7	-	$\mu s$
Settling Time	$t_s$	0.01%, 10V step, Gain = 1	-	1	-	$\mu s$
Phase Margin	$\Phi_M$	$C_L = 10pF$	-	70	-	Deg
Total Harmonic Distortion + Noise	THD+N	Gain = 1, $f = 1kHz$ , $V_O = 3V_{rms}$	-	0.0004	-	%
Equivalent Input Noise Voltage	$V_{NI}$	$f = 0.1Hz$ to $10Hz$	-	0.9	-	$\mu V_{PP}$
	$e_n$	$f = 1kHz$	-	10	-	nV/ $\sqrt{Hz}$
Channel Separation	CS	$f = 1kHz$	-	138	-	dB

**■ ELECTRICAL CHARACTERISTICS**

 ( $V^+ / V^- = \pm 5V$ ,  $V_{COM} = 0V$ ,  $R_L = 2k\Omega$ ,  $T_a = 25^\circ C$ , unless otherwise noted.)

PARAMETER	SYMBOL	TEST CONDITIONS	MIN	TYP	MAX	UNIT
<b>INPUT CHARACTERISTICS</b>						
Input Offset Voltage	$V_{IO}$		-	0.1	0.8	mV
Input Bias Current	$I_B$		-	21	-	pA
Input Offset Current	$I_{IO}$		-	5	-	pA
Input Offset Voltage Drift	$\Delta V_{IO}/\Delta T$	$T_a = -40^\circ C$ to $125^\circ C$	-	1	-	$\mu V/^\circ C$
Input Capacitance	$C_{IN}$		-	10	-	pF
Common-Mode Rejection Ratio	CMR	$V_{ICM} = -2.5V$ to $2.5V$	86	108	-	dB
Common-Mode Input Voltage Range	$V_{ICM}$	CMR $\geq 86$ dB	-2.5	-	2.5	V
<b>OUTPUT CHARACTERISTICS</b>						
High-level Output Voltage	$V_{OH}$	$R_L = 2k\Omega$	3.9	4.2	-	V
		$R_L = 600\Omega$	3.7	4.1	-	V
Low-level Output Voltage	$V_{OL}$	$R_L = 2k\Omega$	-	-4.9	-4.5	V
		$R_L = 600\Omega$	-	-4.8	-4.3	V
Output Short-Circuit Current	$I_{SC}$	Sourcing, $V_O = 0V$	-	52	-	mA
		Sinking, $V_O = 0V$	-	44	-	mA
<b>POWER SUPPLY</b>						
Supply Current (All Amplifiers)	$I_{SUPPLY}$	No Signal	-	2.0	3.0	mA
<b>AC CHARACTERISTICS</b>						
Slew Rate	SR	Gain = 1, $V_{IN} = 2V_{PP}$	-	18	-	V/ $\mu s$
Unity Gain Frequency	$f_T$	$C_L = 10pF$	-	7	-	MHz
Settling Time	$t_s$	0.1%, 4V step, Gain = 1	-	0.5	-	$\mu s$
Phase Margin	$\Phi_M$	$C_L = 10pF$	-	65	-	Deg
Total Harmonic Distortion + Noise	THD+N	Gain = 1, $f = 1kHz$ , $V_O = 1V_{rms}$	-	0.0005	-	%
Equivalent Input Noise Voltage	$V_{NI}$	$f = 0.1Hz$ to $10Hz$	-	0.9	-	$\mu V_{PP}$
	$e_n$	$f = 1kHz$	-	10	-	nV/ $\sqrt{Hz}$
Channel Separation	CS	$f = 1kHz$	-	135	-	dB

## ■ THERMAL CHARACTERISTICS

PACKAGE	SYMBOL	VALUE	UNIT
Junction-to-Ambient Thermal Resistance SOP8 (EMP8)	$\theta_{ja}$	2-Layer / 4-Layer <sup>(4)</sup> 179 / 125	°C/W
Junction-to-Top of Package Characterization Parameter SOP8 (EMP8)	$\psi_{jt}$	2-Layer / 4-Layer <sup>(4)</sup> 31 / 27	°C/W

(4) 2-Layer: Mounted on glass epoxy board (76.2 mm × 114.3 mm × 1.6 mm: based on EIA/JEDEC standard, 2-layer FR-4).

4-Layer: Mounted on glass epoxy board (76.2 mm × 114.3 mm × 1.6 mm: based on EIA/JEDEC standard, 4-layer FR-4), internal Cu area: 74.2 mm × 74.2 mm.

## ■ POWER DISSIPATION vs. AMBIENT TEMPERATURE

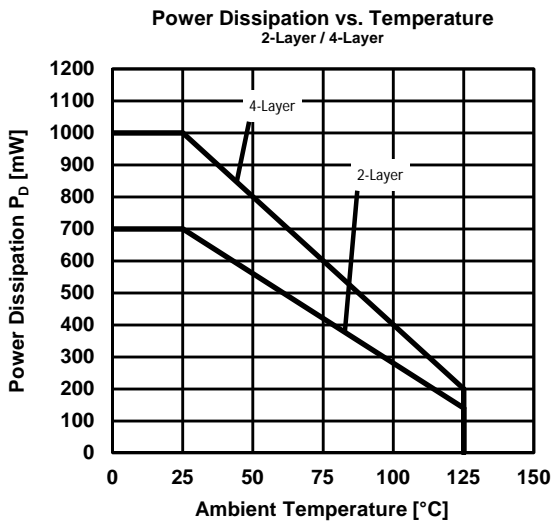

## ■ TYPICAL CHARACTERISTICS

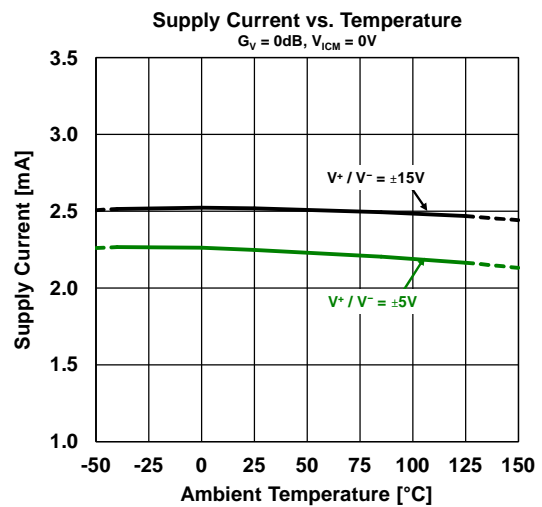
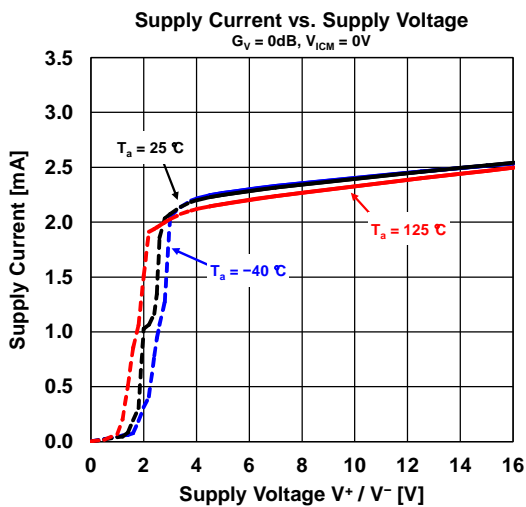
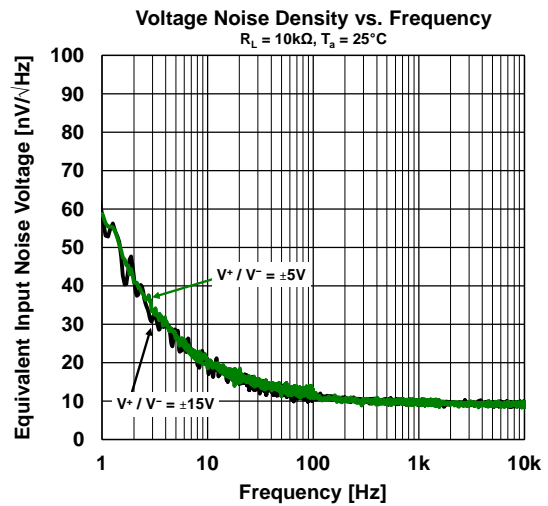
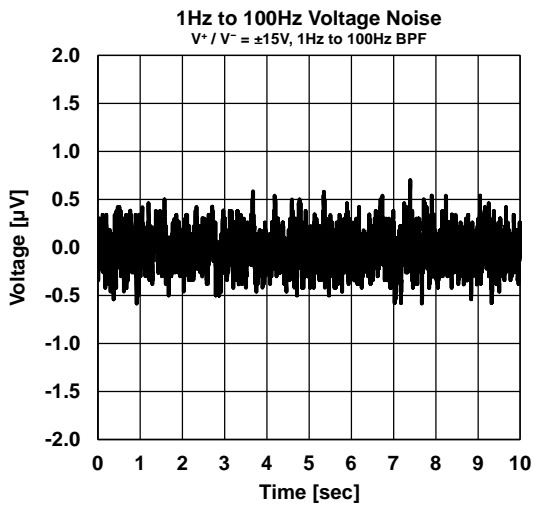
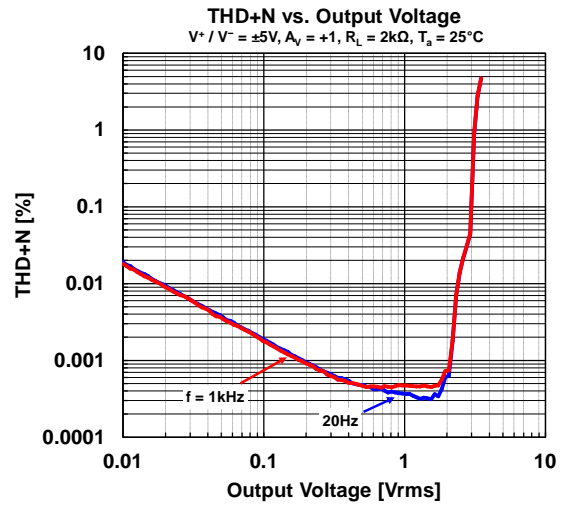
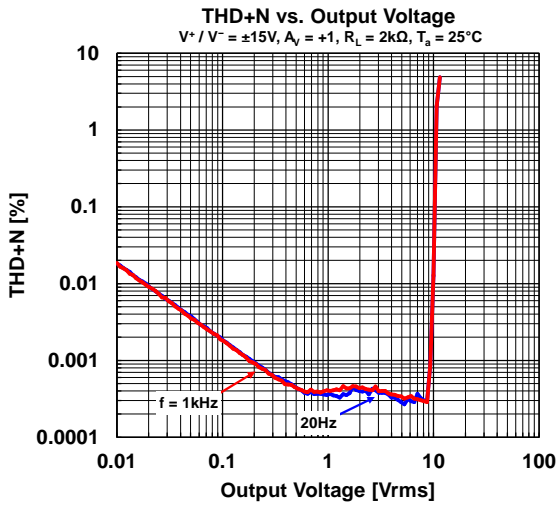

## ■ TYPICAL CHARACTERISTICS

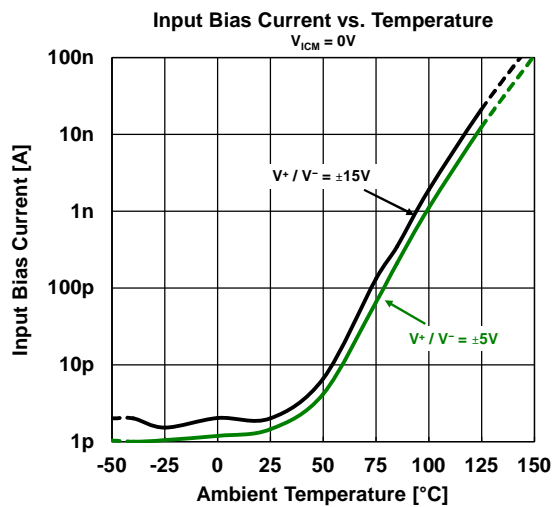
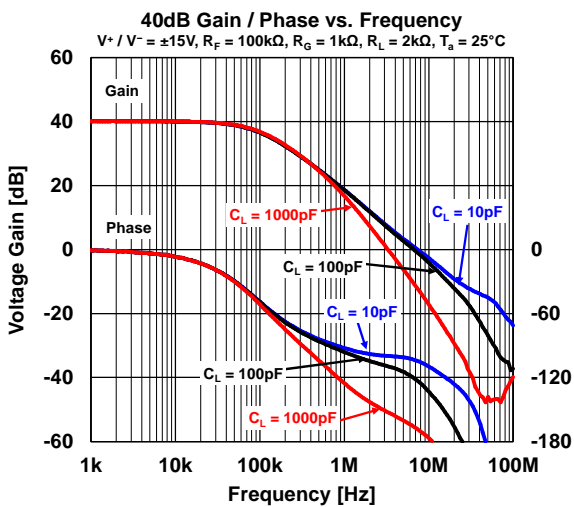
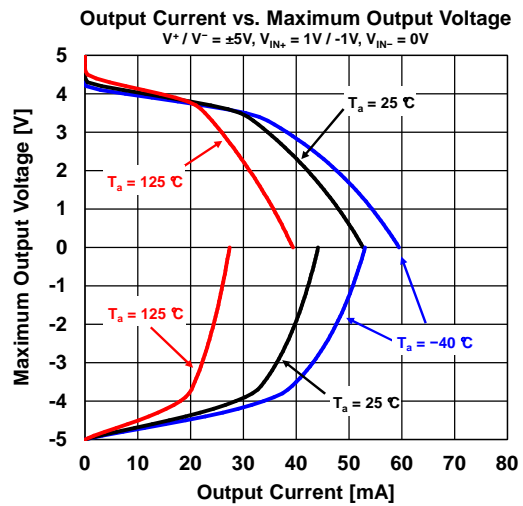
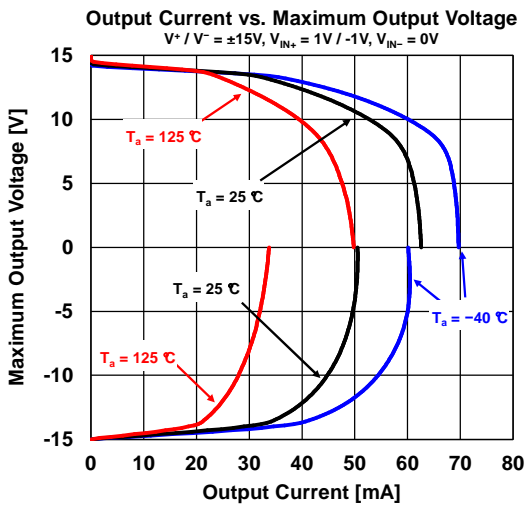
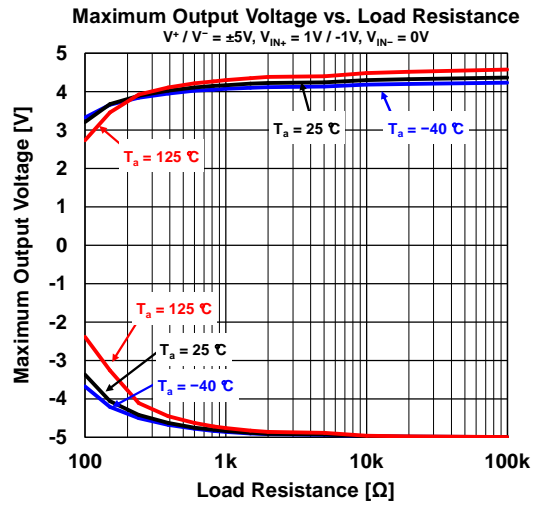
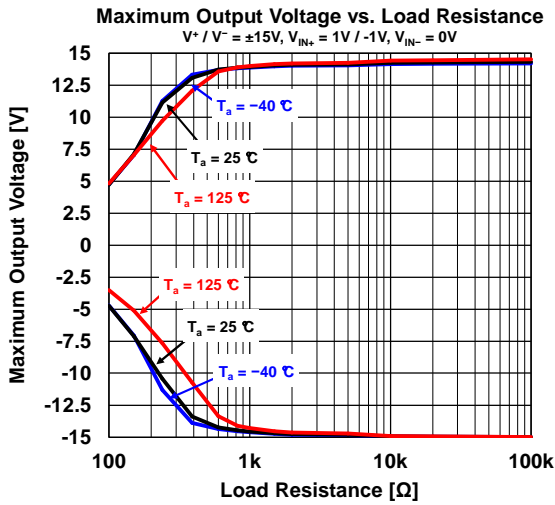



## ■ TYPICAL CHARACTERISTICS

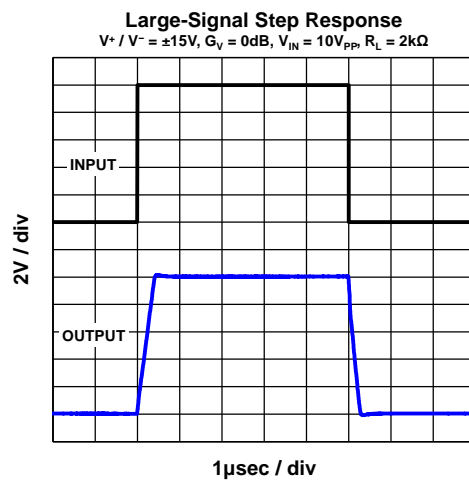
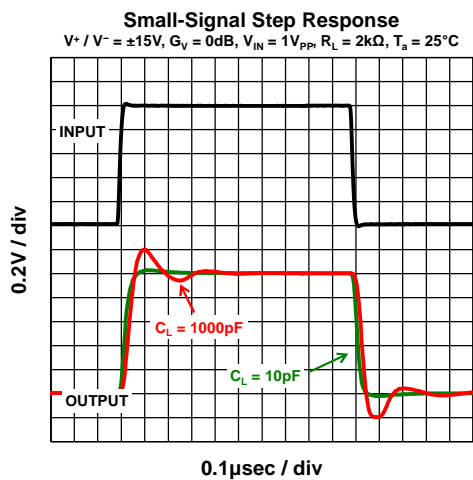
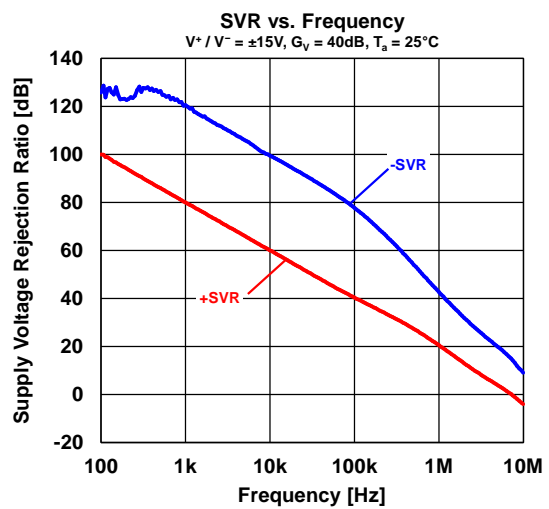
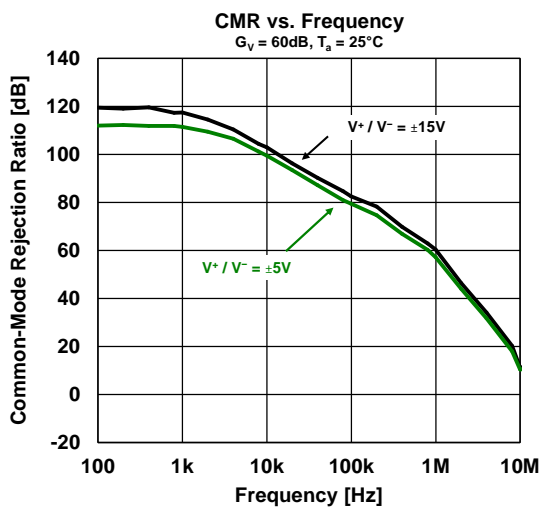
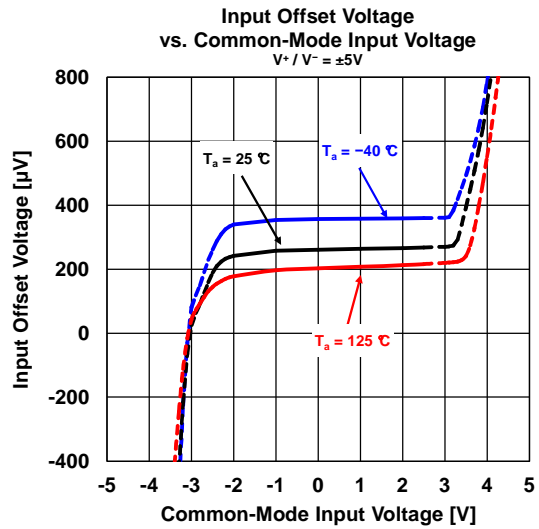
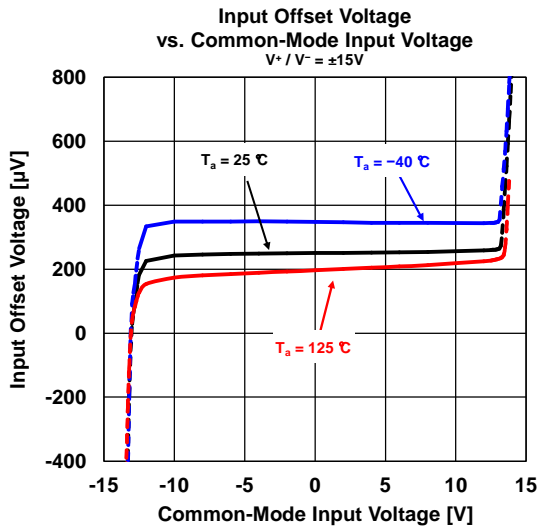

## ■ TYPICAL CHARACTERISTICS

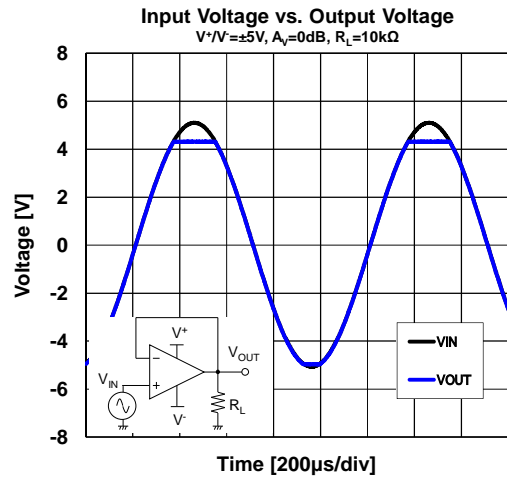
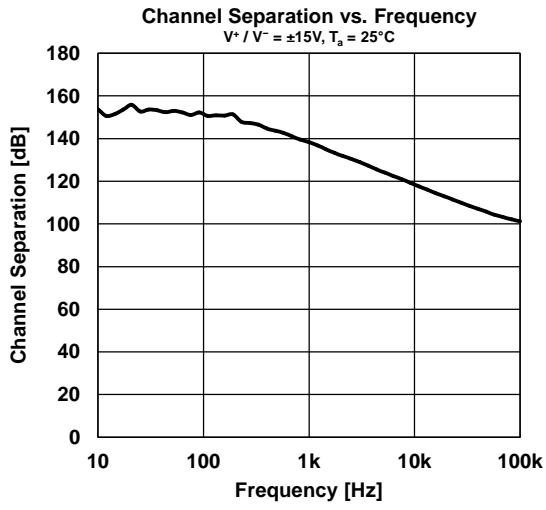

## TEST CIRCUITS

- I<sub>SUPPLY</sub>

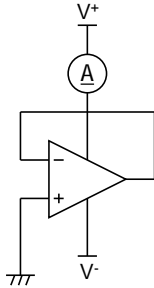

- V<sub>IO</sub>, CMR, SVR

R<sub>G</sub>=50Ω, R<sub>F</sub>=50kΩ

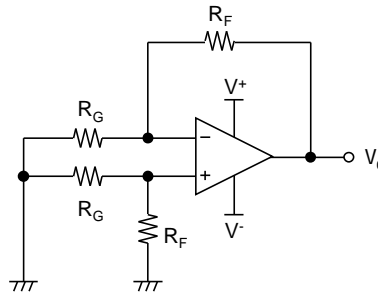

$$V_{IO} = \frac{R_G}{(R_G + R_F)} \times V_O$$

$$CMR = 20 \log \frac{\Delta V_{COM} \left(1 + \frac{R_F}{R_G}\right)}{\Delta V_O}$$

$$SVR = 20 \log \frac{\Delta V_S \left(1 + \frac{R_F}{R_G}\right)}{\Delta V_O}$$

$V_S = V^+ - V^-$

- V<sub>OH</sub>, V<sub>OL</sub>

V<sub>OH</sub>: V<sub>in+</sub> = 1V, V<sub>in-</sub> = 0V

V<sub>OL</sub>: V<sub>in+</sub> = -1V, V<sub>in-</sub> = 0V

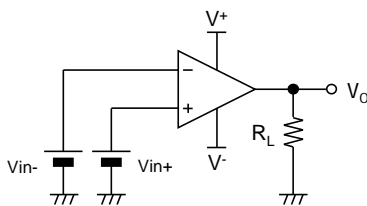

- GBW

R<sub>G</sub>=100Ω, R<sub>F</sub>=10kΩ, C<sub>L</sub>=open

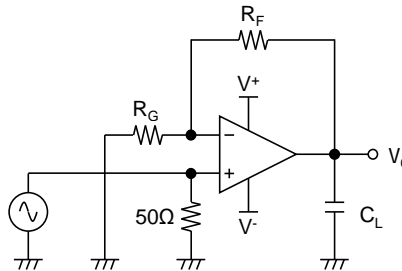

- SR

R<sub>L</sub>=2kΩ, C<sub>L</sub>=10pF

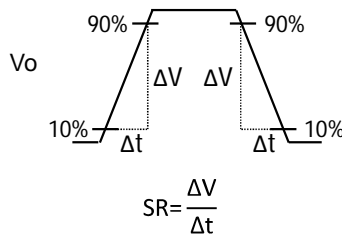
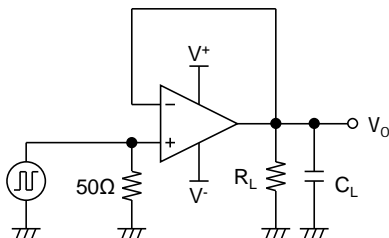

## APPLICATION NOTE

### Single and Dual Supply Voltage Operation

The NJM8087 works with both single supply and dual supply when the voltage supplied is between  $V^+$  and  $V^-$ . These amplifiers operate from single 8V to 32V supply and dual  $\pm 4V$  to  $\pm 16V$  supply.

### Common-Mode Input Voltage Range

When the supply voltage does not meet the condition of electrical characteristics, the range of common-mode input voltage is as follows:

$$V_{ICM} (typ.) = V^- + 2.5V \text{ to } V^+ - 2.5V \quad (T_a = 25^\circ C)$$

Difference of  $V_{ICM}$  when Temperature change, refer to typical characteristic graph.

During designing, consider variations in characteristics for use with allowance.

### Maximum Output Voltage Range

When the supply voltage does not meet the condition of electrical characteristics, the range of the typ. value of the maximum output voltage is as follows:

$$V_{OM} (typ.) = V^- + 0.2V \text{ to } V^+ - 0.9V \quad (R_L = 2k\Omega \text{ to } V^+/2, T_a = 25^\circ C)$$

During designing, consider variations in characteristics and temperature characteristics for use with allowance. In addition, also note that the output voltage range becomes narrow as shown in typical characteristics graph when an output current increases.

### No Phase Reversal

The NJM8087 is designed to prevent phase reversal at the input voltage above the common mode input voltage range. Figure1 shows no phase reversal characteristics with the input voltage exceeding the supply voltage. It is designed to prevent phase reversal at the input voltage above the supply voltage, but the input voltage should not exceed the absolute maximum rating of  $V^- - 0.3V$  or  $V^+ + 0.3V$ . The range of normal operation is the common mode input voltage range shown in the electrical characteristics table.

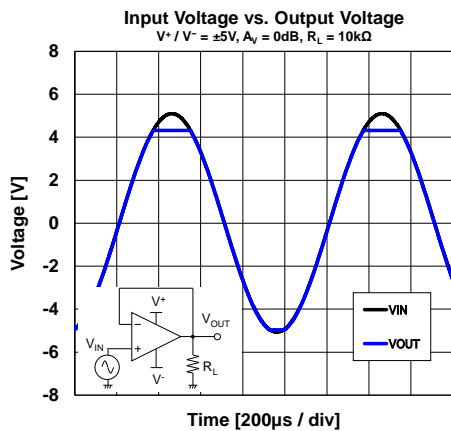

Figure1. No phase reversal

### Capacitive load

The NJM8087 can use at unity gain follower, but the unity gain follower is the most sensitive configuration to capacitive loading. The combination of capacitive load placed directly on the output of an amplifier along with the output impedance of the amplifier creates a phase lag which in turn reduces the phase margin of the amplifier. If phase margin is significantly reduced, the response will cause overshoot and ringing in the step response.

The NJM8087 is unity gain stable for capacitive loads of 1000pF. To drive heavier capacitive loads, an isolation resistor,  $R_{ISO}$  as shown Figure2, should be used.  $R_{ISO}$  improves the feedback loop's phase margin by making the output load resistive at higher frequencies. The larger the value of  $R_{ISO}$ , the more stable the output voltage will be. However, larger values of  $R_{ISO}$  result in reduced output swing, reduced output current drive and reduced frequency bandwidth.

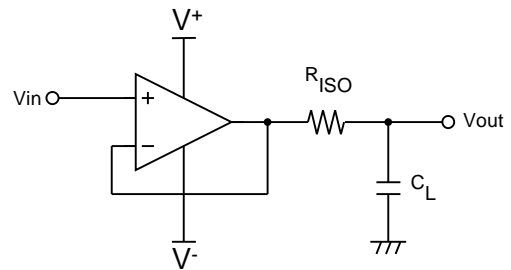

Figure2. Isolating capacitive load

## ■ APPLICATION NOTE

### EMIRR (EMI Rejection Ratio) Definition

EMIRR is a parameter indicating the EMI robustness of an OpAmp. The definition of EMIRR is given by the following equation1.

$$EMIRR = 20 \cdot \log \left( \frac{V_{RF\_PEAK}}{|\Delta V_{IO}|} \right) \quad \text{--- eq.1}$$

$V_{RF\_PEAK}$ : RF Signal Amplitude [V<sub>P</sub>]

$\Delta V_{IO}$ : Input offset voltage shift quantity [V]

The tolerance of the RF signal can be grasped by measuring an RF signal and offset voltage shift quantity. Offset voltage shift is small so that a value of EMIRR is big. And it understands that the tolerance for the RF signal is high. In addition, about the input offset voltage shift with the RF signal, there is the thinking that influence applied to the input terminal is dominant. Therefore, generally the EMIRR becomes value that applied an RF signal to +INPUT terminal.

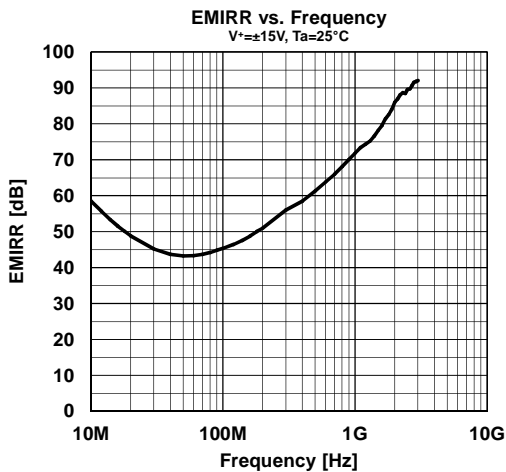

\*For details, refer to "Application Note for EMI Immunity" in our HP: <http://www.njr.com/>

## SOP (EMP8)

Unit: mm

### ■ PACKAGE DIMENSIONS

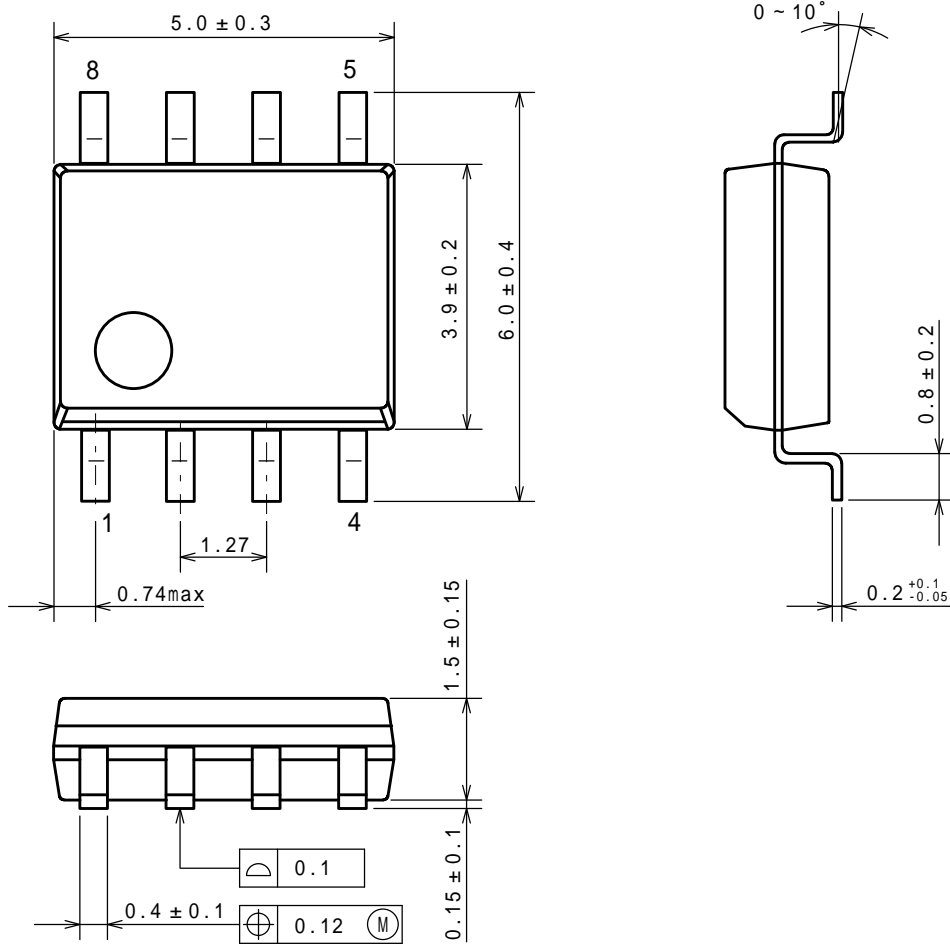

### ■ EXAMPLE OF SOLDER PADS DIMENSIONS

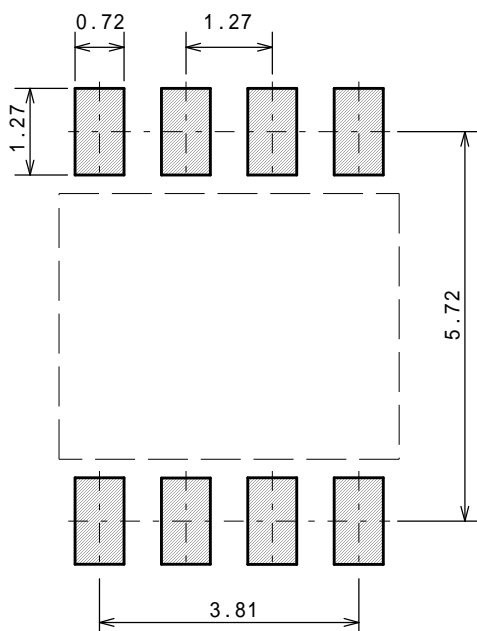

## SOP8 (EMP8)

### PACKING SPEC

Unit: mm

#### TAPING DIMENSIONS

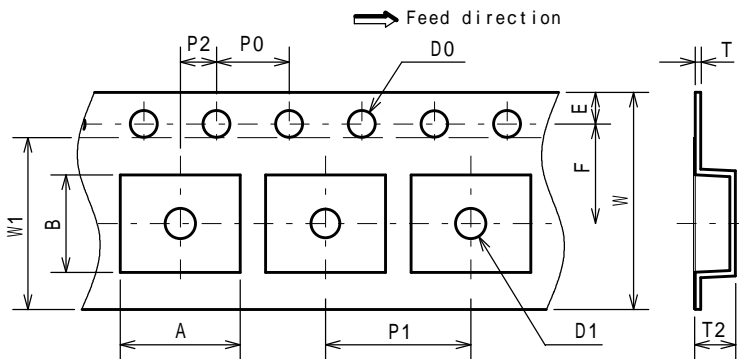

SYMBOL	DIMENSION	REMARKS
A	6.6	BOTTOM DIMENSION
B	5.4	BOTTOM DIMENSION
D0	$1.5^{+0.1}_0$	
D1	$1.7 \pm 0.1$	
E	$1.75 \pm 0.1$	
F	$5.5 \pm 0.05$	
P0	$4.0 \pm 0.1$	
P1	$8.0 \pm 0.1$	
P2	$2.0 \pm 0.05$	
T	$0.30 \pm 0.05$	
T2	2.2	
W	$12.0 \pm 0.3$	
W1	9.5	THICKNESS 0.1max

#### REEL DIMENSIONS

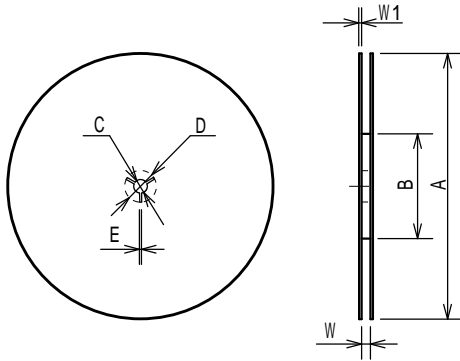

SYMBOL	DIMENSION
A	$330 \pm 2$
B	$80 \pm 1$
C	$13 \pm 0.2$
D	$21 \pm 0.8$
E	$2 \pm 0.5$
W	$13.5 \pm 0.5$
W1	$2.0 \pm 0.2$

#### TAPING STATE

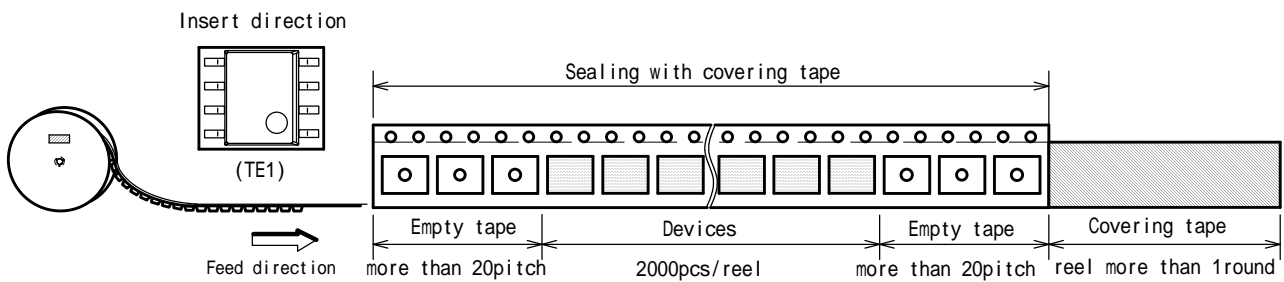

#### PACKING STATE

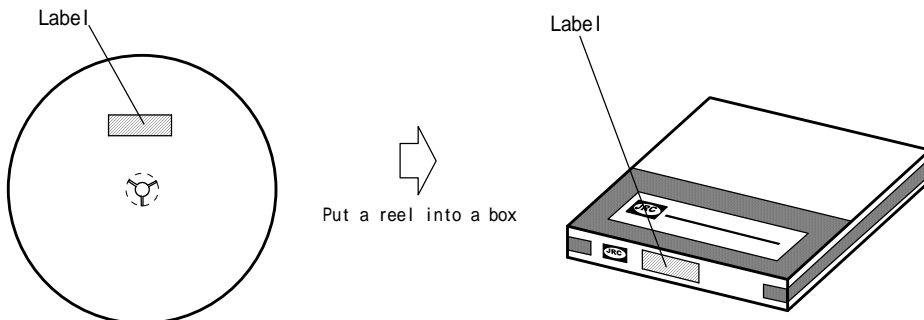

## ■ RECOMMENDED MOUNTING METHOD

### INFRARED REFLOW SOLDERING PROFILE

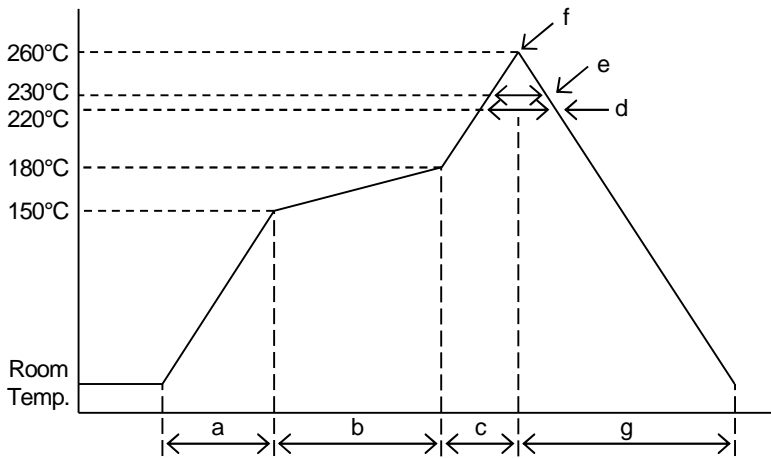

a	Temperature ramping rate	1 to 4°C/s
b	Pre-heating temperature	150 to 180°C
	Pre-heating time	60 to 120s
c	Temperature ramp rate	1 to 4°C/s
d	220°C or higher time	shorter than 60s
e	230°C or higher time	shorter than 40s
f	Peak temperature	lower than 260°C
g	Temperature ramping rate	1 to 6°C/s

The temperature indicates at the surface of mold package.

## ■ REVISION HISTORY

DATE	REVISION	CHANGES
April 13, 2021	Ver.1.0	Initial release.



**[ CAUTION ]**

1. NJR strives to produce reliable and high quality semiconductors. NJR's semiconductors are intended for specific applications and require proper maintenance and handling. To enhance the performance and service of NJR's semiconductors, the devices, machinery or equipment into which they are integrated should undergo preventative maintenance and inspection at regularly scheduled intervals. Failure to properly maintain equipment and machinery incorporating these products can result in catastrophic system failures
2. The specifications on this datasheet are only given for information without any guarantee as regards either mistakes or omissions. The application circuits in this datasheet are described only to show representative usages of the product and not intended for the guarantee or permission of any right including the industrial property rights.  
All other trademarks mentioned herein are the property of their respective companies.
3. To ensure the highest levels of reliability, NJR products must always be properly handled.  
The introduction of external contaminants (e.g. dust, oil or cosmetics) can result in failures of semiconductor products.
4. NJR offers a variety of semiconductor products intended for particular applications. It is important that you select the proper component for your intended application. You may contact NJR's Sales Office if you are uncertain about the products listed in this datasheet.
5. Special care is required in designing devices, machinery or equipment which demand high levels of reliability. This is particularly important when designing critical components or systems whose failure can foreseeably result in situations that could adversely affect health or safety. In designing such critical devices, equipment or machinery, careful consideration should be given to amongst other things, their safety design, fail-safe design, back-up and redundancy systems, and diffusion design.
6. The products listed in this datasheet may not be appropriate for use in certain equipment where reliability is critical or where the products may be subjected to extreme conditions. You should consult our sales office before using the products in any of the following types of equipment.
  - Aerospace Equipment
  - Equipment Used in the Deep Sea
  - Power Generator Control Equipment (Nuclear, steam, hydraulic, etc.)
  - Life Maintenance Medical Equipment
  - Fire Alarms / Intruder Detectors
  - Vehicle Control Equipment (Airplane, railroad, ship, etc.)
  - Various Safety Devices
7. NJR's products have been designed and tested to function within controlled environmental conditions. Do not use products under conditions that deviate from methods or applications specified in this datasheet. Failure to employ the products in the proper applications can lead to deterioration, destruction or failure of the products. NJR shall not be responsible for any bodily injury, fires or accident, property damage or any consequential damages resulting from misuse or misapplication of the products. The products are sold without warranty of any kind, either express or implied, including but not limited to any implied warranty of merchantability or fitness for a particular purpose.
8. Warning for handling Gallium and Arsenic (GaAs) Products (Applying to GaAs MMIC, Photo Reflector). These products use Gallium (Ga) and Arsenic (As) which are specified as poisonous chemicals by law. For the prevention of a hazard, do not burn, destroy, or process chemically to make them as gas or power. When the product is disposed of, please follow the related regulation and do not mix this with general industrial waste or household waste.
9. The product specifications and descriptions listed in this datasheet are subject to change at any time, without notice.



## X-ON Electronics

Largest Supplier of Electrical and Electronic Components

*Click to view similar products for [Operational Amplifiers - Op Amps](#) category:*

*Click to view products by [Nisshinbo](#) manufacturer:*

Other Similar products are found below :

[NCV33072ADR2G](#) [LM358SNG](#) [430227FB](#) [UPC824G2-A](#) [LT1678IS8](#) [042225DB](#) [058184EB](#) [UPC822G2-A](#) [UPC259G2-A](#) [UPC258G2-A](#)  
[NCV33202DMR2G](#) [NTE925](#) [AZV358MTR-G1](#) [AP4310AUMTR-AG1](#) [HA1630D02MMEL-E](#) [HA1630S01LPEL-E](#) [SCY33178DR2G](#)  
[NJU77806F3-TE1](#) [NCV5652MUTWG](#) [NCV20034DR2G](#) [LM324EDR2G](#) [LM2902EDR2G](#) [NTE7155](#) [NTE778S](#) [NTE871](#) [NTE924](#) [NTE937](#)  
[MCP6V17T-E/MNY](#) [MCP6V19-E/ST](#) [MXD8011HF](#) [MCP6V17T-E/MS](#) [SCY6358ADR2G](#) [ADA4523-1BCPZ](#) [LTC2065HUD#PBF](#)  
[ADA4523-1BCPZ-RL7](#) [NJM2904CRB1-TE1](#) [2SD965T-R](#) [RS6332PXK](#) [BDM8551](#) [BDM321](#) [MD1324](#) [COS8052SR](#) [COS8552SR](#)  
[COS8554SR](#) [COS2177SR](#) [COS2353SR](#) [COS724TR](#) [ASOPD4580S-R](#) [RS321BKXF](#) [ADA4097-1HUIZ-RL7](#)