

150 mA 24 V Input High Voltage Regulator

NO.EA-270-220614

OUTLINE

The R1155x is a CMOS-based 24 V input voltage regulator featuring 150 mA output that provides high output voltage accuracy and low supply current. Internally, the R1155x consists of a voltage reference unit, an error amplifier, and a resistor net for setting output voltage. As protection circuits, the R1155x contains a current limit circuit, a fold-back protection circuit, a thermal shutdown circuit and a reverse current protection circuit.

The R1155x is available in the fixed output voltage type (R1155xxxxB), and the adjustable output voltage type (R1155x001C). The output voltage accuracy for the fixed output voltage type is as high as $\pm 2.0\%$.

The R1155x is offered in a 5-pin SOT-89-5 package and a 5-pin SOT-23-5 package.

FEATURES

- Supply Current Typ. 7.5 μA ($V_{\text{IN}} = 6.0 \text{ V}$ or 3.0 V)
- Standby Current Typ. 0.1 μA
- Output Current Min. 150 mA ($V_{\text{IN}} = 6.0 \text{ V}$ or 3.0 V)
- Output Voltage Accuracy $\pm 2.0\%$
- Package SOT-23-5, SOT-89-5
- Input Voltage Range Max. 24.0 V
- Output Voltage Range Fixed Output Voltage Type: 2.5 V to 12.0 V
Adjustable Output Voltage Type: 2.5 V, 2.5 V to 23.0 V
using external resistor
- Fold-back Protection Circuit Typ. 30 mA
- Thermal Shutdown Circuit
- Reverse Current Protection Circuit
- Ceramic Capacitor Capable $C_{\text{OUT}} = 4.7 \mu\text{F}$ or more

APPLICATIONS

- Power source for home appliances (refrigerators, rice cookers, electric water warmers, etc.)
- Power source for in-car audio systems, in-car navigation systems, ETC systems, and reset circuits
- Power source for laptop personal computers, digital TVs, cordless phones, and private LAN systems for home, and reset circuits
- Power source for copiers, printers, facsimiles, scanners, and reset circuits

SELECTION GUIDE

The output voltage, the output voltage type, and the package type for the ICs are user-selectable options.

Selection Guide

Product Name	Package	Quantity per Reel	Pb Free	Halogen Free
R1155Nxxx*-TR-FE	SOT-23-5	3,000 pcs	Yes	Yes
R1155Hxxx*-T1-FE	SOT-89-5	1,000 pcs	Yes	Yes

xxx: Designation of the output voltage (V_{SET})

For Fixed Output Voltage Type: 2.5 V (025) to 12 V (120) in 0.1 V steps

For Adjustable Output Voltage Type: 2.5 V (001) only

*: Designation of the output voltage type

(B) Fixed Output Voltage Type

(C) Adjustable Output Voltage Type

BLOCK DIAGRAMS

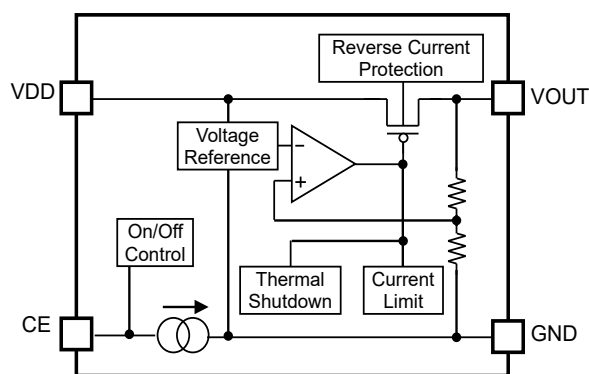

R1155xxxxB Block Diagram
(Fixed Output Voltage Type)

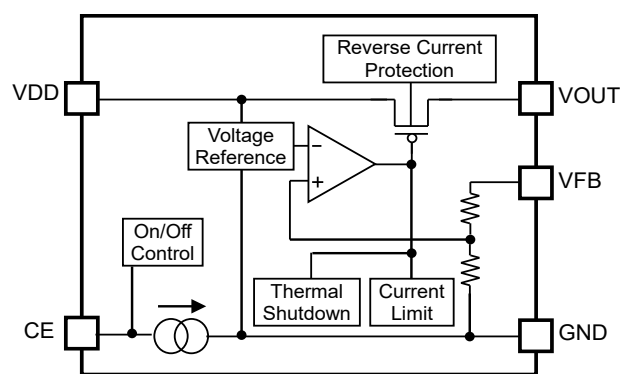

R1155x001C Block Diagram
(Adjustable Output Voltage Type)

PIN DESCRIPTION

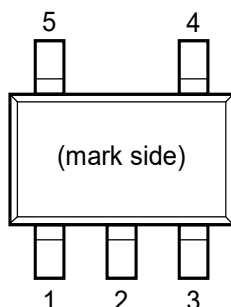

SOT-23-5 Pin Configuration

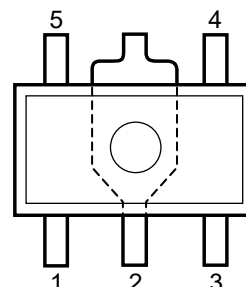

SOT-89-5 Pin Configuration

SOT-23-5 Pin Description

Pin No	Symbol	Description	
1	VOUT	VR Output Pin	
2	GND	Ground Pin	
3	VDD	Input Pin	
4	TP ¹	R1155NxxxB	Test Pin
	VFB ²	R1155N001C ³	VR Adjustment Pin
5	CE	Chip Enable Pin, Active-high	

SOT-89-5 Pin Description

Pin No	Symbol	Description	
1	VOUT	VR Output Pin	
2	GND	Ground Pin	
3	CE	Chip Enable Pin, Active-high	
4	TP ¹	R1155HxxxB	Test Pin
	VFB ²	R1155H001C ³	VR Adjustment Pin
5	VDD	Input Pin	

¹ The TP pin must be connected to GND.

² A 24 K Ω or less voltage setting resistor must be connected to the VFB pin.

³ As for the adjustable output voltage type (R1155N001C), please refer to *ADJUSTABLE OUTPUT VOLTAGE TYPE SETTING*.

PIN EQUIVALENT CIRCUIT DIAGRAMS

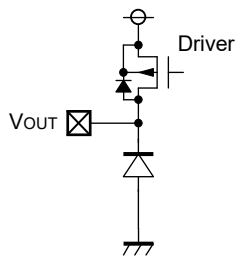

VOUT Pin Equivalent Circuit Diagram

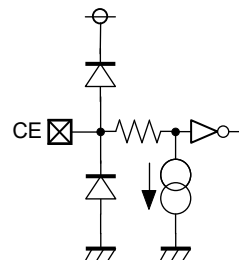

CE Pin Equivalent Circuit Diagram

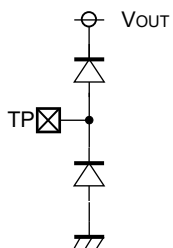

**TP Pin Equivalent Circuit Diagram
(R1155xxxxB)**

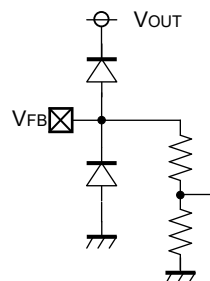

**VFB Pin Equivalent Circuit Diagram
(R1155x001C)**

ABSOLUTE MAXIMUM RATINGS

Absolute Maximum Ratings

Symbol	Item	Rating	Unit
V_{IN}	Input Voltage	-0.3 to 26	V
V_{CE}	Input Voltage (CE Pin)	-0.3 to $V_{IN} + 0.3$	V
V_{OUT}	Output Voltage	-0.3 to 26	V
V_{VFB}	Output Voltage (VFB Pin)	-0.3 to 26	V
I_{OUT}	Output Current	350	mA
P_D	Power Dissipation	Refer to Appendix "Power Dissipation"	
T_j	Junction Temperature	-40 to 125	°C
T_{stg}	Storage Temperature Range	-55 to 125	°C

ABSOLUTE MAXIMUM RATINGS

Electronic and mechanical stress momentarily exceeded absolute maximum ratings may cause permanent damage and may degrade the life time and safety for both device and system using the device in the field. The functional operation at or over these absolute maximum ratings is not assured.

RECOMMENDED OPERATING CONDITIONS

Recommended Operating Ratings

Symbol	Item	Ratings	Unit
T_a	Operating Temperature Range	-40 to 105	°C
V_{IN}	Input Voltage	3.5 to 24	V

RECOMMENDED OPERATING RATINGS

All of electronic equipment should be designed that the mounted semiconductor devices operate within the recommended operating ratings. The semiconductor devices cannot operate normally over the recommended operating ratings, even if they are used over such ratings by momentary electronic noise or surge. And the semiconductor devices may receive serious damage when they continue to operate over the recommended operating ratings.

ELECTRICAL CHARACTERISTICS

$V_{IN} = V_{CE} = V_{SET} + 3.0 \text{ V}$, $C_{OUT} = 4.7 \text{ }\mu\text{F}$, $I_{OUT} = 1 \text{ mA}$, unless otherwise noted.

The specifications surrounded by are guaranteed by Design Engineering at $-40^{\circ}\text{C} \leq T_a \leq 105^{\circ}\text{C}$.

R1155xxxxB, R1155x001C Electrical Characteristics

($T_a = 25^{\circ}\text{C}$)

Symbol	Item	Conditions	Min.	Typ.	Max.	Unit	
I_{LIM}	Output Current	$V_{IN} = V_{SET} + 4 \text{ V}$	150			mA	
V_{OUT}	Output Voltage (Low Power Mode)	$I_{OUT} = 1 \text{ mA}$	$T_a = 25^{\circ}\text{C}$	x0.98		x1.02	V
			$-40^{\circ}\text{C} \leq T_a \leq 105^{\circ}\text{C}$	x0.955		x1.03	V
I_{SS1}	Supply Current (Low Power Mode)	$I_{OUT} = 0 \text{ mA}$	$2.5 \leq V_{SET} \leq 4.2 \text{ V}$		7.5	22	μA
			$4.2 < V_{SET} \leq 8.4 \text{ V}$		8.6	22	μA
			$8.4 < V_{SET} \leq 12 \text{ V}$		9.5	22	μA
I_{SS2}	Supply Current (Fast Mode)	$I_{OUT} = 10 \text{ mA}$		65	125	μA	
$I_{standby}$	Standby Current	$V_{IN} = 24 \text{ V}$, $V_{CE} = 0 \text{ V}$		0.1	1.0	μA	
ΔV_{OUT}	Output Voltage Deviation When Switching Mode	$1 \text{ mA} \leq I_{OUT} \leq 6 \text{ mA}$	-1.5	0	1.5	%	
$\frac{\Delta V_{OUT}}{\Delta I_{OUT}}$	Load Regulation (Fast Mode)	$6 \text{ mA} \leq I_{OUT} \leq 150 \text{ mA}$	$2.5 \leq V_{SET} \leq 5 \text{ V}$		30	90	mV
			$5 < V_{SET} \leq 12 \text{ V}$		30	100	mV
$\frac{\Delta V_{OUT}}{\Delta V_{IN}}$	Line Regulation (Low Power Mode)	$V_{SET} + 0.2 \text{ V} \leq V_{IN} \leq 24 \text{ V}$	$I_{OUT} = 1 \text{ mA}$		0.3	1.3	%
	Line Regulation (Fast Mode)	$V_{SET} + 0.2 \text{ V} \leq V_{IN} \leq 24 \text{ V}$	$I_{OUT} = 10 \text{ mA}$		1.2	2.4	%
V_{DIF}	Dropout Voltage	$I_{OUT} = 150 \text{ mA}$	$2.5 \text{ V} \leq V_{SET} < 3.3 \text{ V}$		1.6	2.6	V
			$3.3 \text{ V} \leq V_{SET} < 5 \text{ V}$		0.96	2.1	V
			$5 \leq V_{SET} \leq 12 \text{ V}$		0.55	1.7	V
RR	Ripple Rejection (Fast Mode)	$f = 1 \text{ kHz}$, 0.5 V_{p-p} , $I_{OUT} = 10 \text{ mA}$	$2.5 \leq V_{SET} < 5 \text{ V}$		60		dB
			$5 \leq V_{SET} \leq 12 \text{ V}$		50		dB
$\frac{\Delta V_{OUT}}{\Delta T_a}$	Output Voltage Temperature Coefficient	$I_{OUT} = 1 \text{ mA}$, $-40^{\circ}\text{C} \leq T_a \leq 105^{\circ}\text{C}$		± 100		ppm/ $^{\circ}\text{C}$	
I_{OUTH}	Fast Mode Switching Current	$I_{OUT} = \text{Light Load} \rightarrow \text{Heavy Load}$	2.4	4.5	6.5	mA	
I_{OUTL}	Low Power Mode Switching Current	$I_{OUT} = \text{Heavy Load} \rightarrow \text{Light Load}$	0.6	1.5	2.4	mA	
I_{SC}	Short Current Limit	$V_{OUT} = 0 \text{ V}$		30		mA	
V_{CEH}	CE Input Voltage "H"		1.35		V_{IN}	V	
V_{CEL}	CE Input Voltage "L"		0		0.5	V	
T_{TSD}	Thermal Shutdown Temperature	Junction Temperature		145		$^{\circ}\text{C}$	
T_{TSR}	Thermal Shutdown Released Temperature	Junction Temperature		120		$^{\circ}\text{C}$	

All test items listed under *ELECTRICAL CHARACTERISTICS* are done under the pulse load condition ($T_j \approx T_a = 25^{\circ}\text{C}$) except for Ripple Rejection and Output Voltage Temperature Coefficient.

ELECTRICAL CHARACTERISTICS (continued)

$V_{IN} = V_{CE} = V_{SET} + 3.0 \text{ V}$, $C_{OUT} = 4.7 \text{ }\mu\text{F}$, $I_{OUT} = 1 \text{ mA}$, unless otherwise noted.

The specifications surrounded by are guaranteed by Design Engineering at $-40^{\circ}\text{C} \leq T_a \leq 105^{\circ}\text{C}$.

R1155xxxxB, R1155x001C Electrical Characteristics

(Ta = 25°C)

Symbol	Item	Conditions	Min.	Typ.	Max.	Unit
I _{REV}	Reverse Current Limit	CE = GND, V _{IN} = V _{SET} + 0.02 V	2.5 ≤ V _{SET} < 5 V	1.0	3.5	μA
			5 ≤ V _{SET} ≤ 12 V	2.0	6.0	μA
V _{REV_DET}	Reverse Current Protection Mode Detection Offset ¹ V _{REV} = V _{DD} - V _{OUT}	0 ≤ V _{IN} ≤ 24.0 V, V _{OUT} ≥ 2.0 V	20			mV
V _{REV_REL}	Reverse Current Protection Mode Release Offset ¹	0 ≤ V _{IN} ≤ 24.0 V, V _{OUT} ≥ 2.0 V			220	mV

All test items listed under *ELECTRICAL CHARACTERISTICS* are done under the pulse load condition (T_j ≈ T_a = 25°C) except for Ripple Rejection and Output Voltage Temperature Coefficient.

¹ The operation of reverse current protection circuit is guaranteed when V_{OUT} ≥ 2.0 V. The reverse current protection mode is always turned on when V_{IN} = 0 V.

THEORY OF OPERATION

Power Activation

When starting up the IC using the input voltages of the VDD and CE pins simultaneously with no load, the both pin voltages have to be 0.06 V/ ms or faster. When starting up the IC using the both pin voltages at 0.06 V/ ms or slower with no load, the VDD pin has to be started up before the CE pin.

Thermal Shutdown Circuit

The R1155x contains a thermal shutdown circuit, which stops regulator operation if the junction temperature of the R1155x becomes higher than 145°C (Typ.). Additionally, if the junction temperature after the regulator being stopped decreases to a level below 120°C (Typ.), it restarts regulator operation. As a result the operation of the thermal shutdown circuit causes the regulator repeatedly to turn off and on until the causes of overheating are removed. As a consequence a pulse shaped output voltage occurs.

Reverse Current Protection Circuit

The R1155x includes a reverse current protection circuit, which stops the reverse current flowing from the VOUT to VDD pins or to GND pin when V_{OUT} becomes more than V_{IN} .

Usually, the LDO using Pch output transistor contains a parasitic diode between VDD pin and VOUT pin. Therefore, if V_{OUT} is more than V_{IN} , the parasitic diode becomes forward direction. As a result, the current flows from VOUT pin to VDD pin.

The R1155x switches the mode to the reverse current protection mode before V_{IN} becomes smaller than V_{OUT} by connecting the parasitic diode of Pch output transistor to the backward direction, and connecting the gate to VOUT pin. As a result, the Pch output transistor is turned off and the all the current pathways from VOUT pin to GND pin are shut down to maintain the reverse current lower than $[I_{REV}]$ of the Electrical Characteristics. Switching to either the normal mode or to the reverse current protection mode is determined by the magnitude of V_{IN} voltage and V_{OUT} voltage. For the stable operation, offset and hysteresis are set as the threshold. The detection/ release thresholds of both normal and reverse current protection modes are specified by $[V_{REV_DET}]$ and $[V_{REV_REL}]$ of the Electrical Characteristics. Therefore, the minimum dropout voltage under the small load current condition is restricted by the value of $[V_{REV_REL}]$.

It shows the normal operation mode and reverse current protection mode, respectively. Shows the detection/ release timing of reverse current protection function. When giving the VOUT pin a constant-voltage and decreasing the V_{IN} voltage, the dropout voltage will become lower than the $[V_{REV_DET}]$. As a result, the reverse current protection starts to function to stop the load current. By increasing the dropout voltage more than the $[V_{REV_REL}]$, the protection mode will be released to let the load current to flow. If the dropout voltage to be used is smaller than $[V_{REV_REL}]$, the detection and the release may be repeated.

The operation coverage of the reverse current protection circuit is $V_{OUT} \geq 1.5$ V. However, under the condition of $V_{IN} = 0$ V, always the reverse current protection mode is operating.

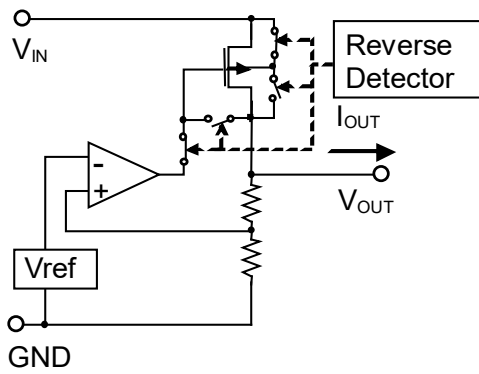

Normal Operation Mode

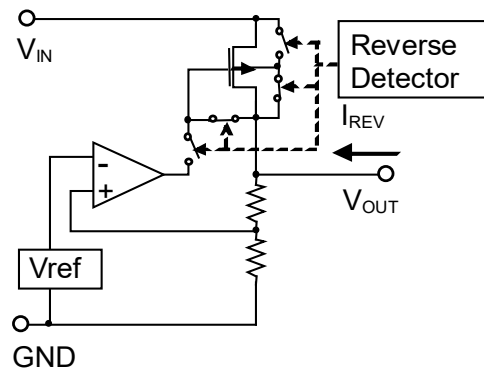

Reverse Current Protection Mode

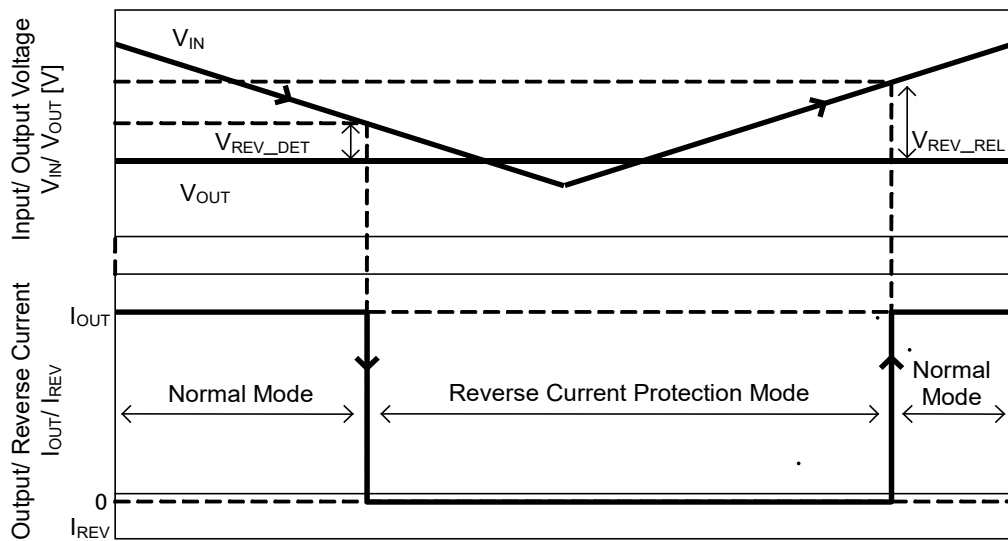

Detection/ Release Timing of Reverse Current Protection Function

APPLICATION INFORMATION

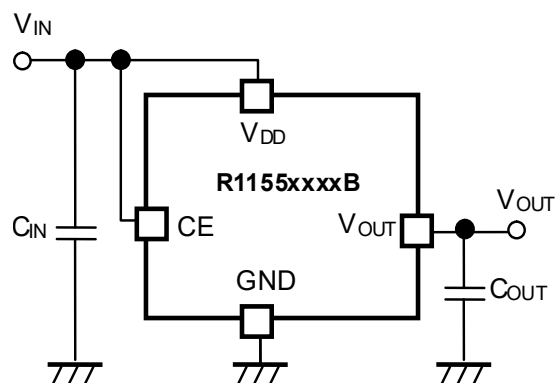

R1155xxxxB Typical Application
(Fixed Output Voltage Type)

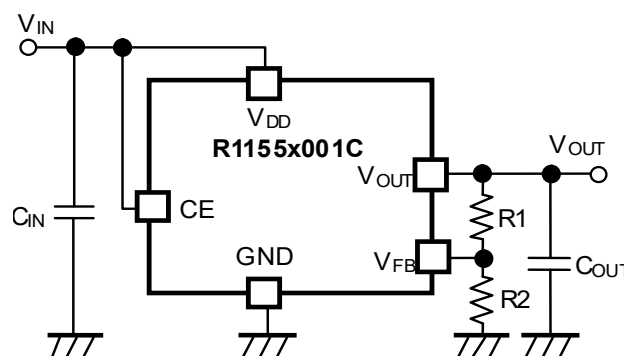

R1155x001C Typical Application
(Adjustable Output Voltage Type)

Technical Notes on the Components Selection

- In the R1155x, phase compensation is provided to secure stable operation even when the load current is varied. For this purpose, use a 4.7 μF or more output capacitor (C_{OUT}) with good frequency characteristics and proper ESR (Equivalent Series Resistance). In case of using a tantalum type capacitor and the ESR value of the capacitor is large, the output might be unstable. Evaluate the circuit including consideration of frequency characteristics.
- Ensure the VDD and GND lines are sufficiently robust. If their impedance is too high, noise pickup or unstable operation may result. Connect C_{OUT} with suitable values between the VOUT and GND pins, and as close as possible to the pins.

Adjustable Output Voltage Type Setting (R1155x001C)

The output voltage of the R1155x001C can be adjusted up to 23 V by using the external divider resistors (R1, R2). The resistance value for R2 should be set to 24 KΩ or less. By using the following equations, the output voltage can be determined. V_{FB} voltage which is fixed inside the IC is described as $setV_{FB}$. $setV_{FB}$ is 2.5 V. When using the R1155x001C with 2.5 V, please connect the VOUT pin to the VFB pin.

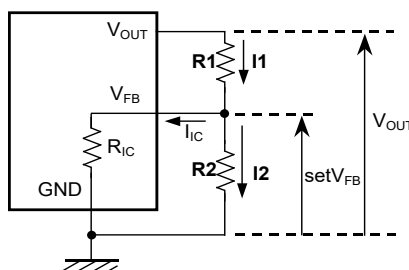

Output Voltage Adjustment Using External Divider Resistors

$$I1 = I_{IC} + I2 \dots \dots \dots (1)$$

$$I2 = setV_{FB} / R2 \dots \dots \dots (2)$$

Thus,

$$I1 = I_{IC} + setV_{FB} / R2 \dots \dots \dots (3)$$

Therefore,

$$V_{OUT} = setV_{FB} + R1 \times I1 \dots \dots \dots (4)$$

Insert Equation (3) into Equation (4), so

$$\begin{aligned} V_{OUT} &= setV_{FB} + R1 \times (I_{IC} + setV_{FB} / R2) \\ &= setV_{FB} \times (1 + R1 / R2) + R1 \times I_{IC} \dots \dots \dots (5) \end{aligned}$$

In Equation (5), $R1 \times I_{IC}$ is the error-causing factor in V_{OUT} .

As for I_{IC} ,

$$I_{IC} = setV_{FB} / R_{IC} \dots \dots \dots (6)$$

Therefore, the error-causing factor $R1 \times I_{IC}$ can be described as follows.

$$\begin{aligned} R1 \times I_{IC} &= R1 \times setV_{FB} / R_{IC} \\ &= setV_{FB} \times R1 / R_{IC} \dots \dots \dots (7) \end{aligned}$$

For better accuracy, choosing $R1 \ll R_{IC}$ reduces this error.

Without the error-causing factor $R1 \times I_{IC}$, the output voltage can be calculated by the following equation.

$$V_{OUT} = setV_{FB} \times ((R1 + R2) / R2) \dots \dots \dots (8)$$

R_{IC} of the R1155x001C is approximately Typ.8.4 MΩ ($T_a = 25^\circ\text{C}$, guaranteed by Design Engineering).

R_{IC} could be affected by the temperature, therefore evaluate the circuit taking the actual conditions of use into account when deciding the resistance values for R1 and R2.

Equivalent Series Resistance (ESR) vs. Output Current (I_{OUT})

It is recommended that a ceramic type capacitor be used for the R1155x. However, other types of capacitors having lower ESR can also be used. The relation between the output current (I_{OUT}) and the ESR of output capacitor is shown below.

Measurement Conditions:

- Noise Frequency Band: 10 Hz to 2 MHz
- Measurement Temperature: -40°C to $+105^{\circ}\text{C}$
- Hatched Area: Noise level is 40 μV (avg.) or below.
- C_{IN} : 0.1 μF
- C_{OUT} : 4.7 μF

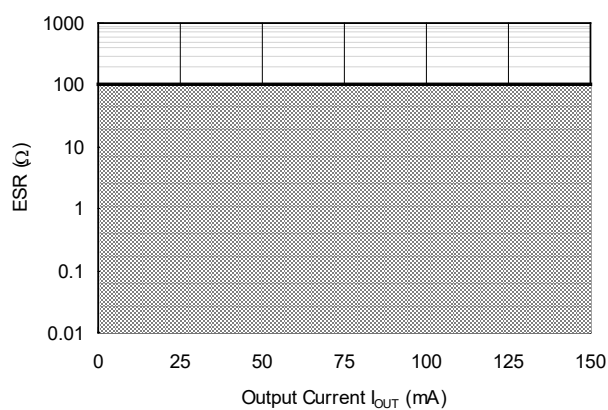
**ESR vs. Output Current**

TYPICAL CHARACTERISTICS

Note: Typical Characteristics are intended to be used as reference data; they are not guaranteed.

1) Output Voltage vs. Output Current ($C_{IN} = 0.1 \mu\text{F}$, $C_{OUT} = 4.7 \mu\text{F}$, $T_a = 25^\circ\text{C}$)

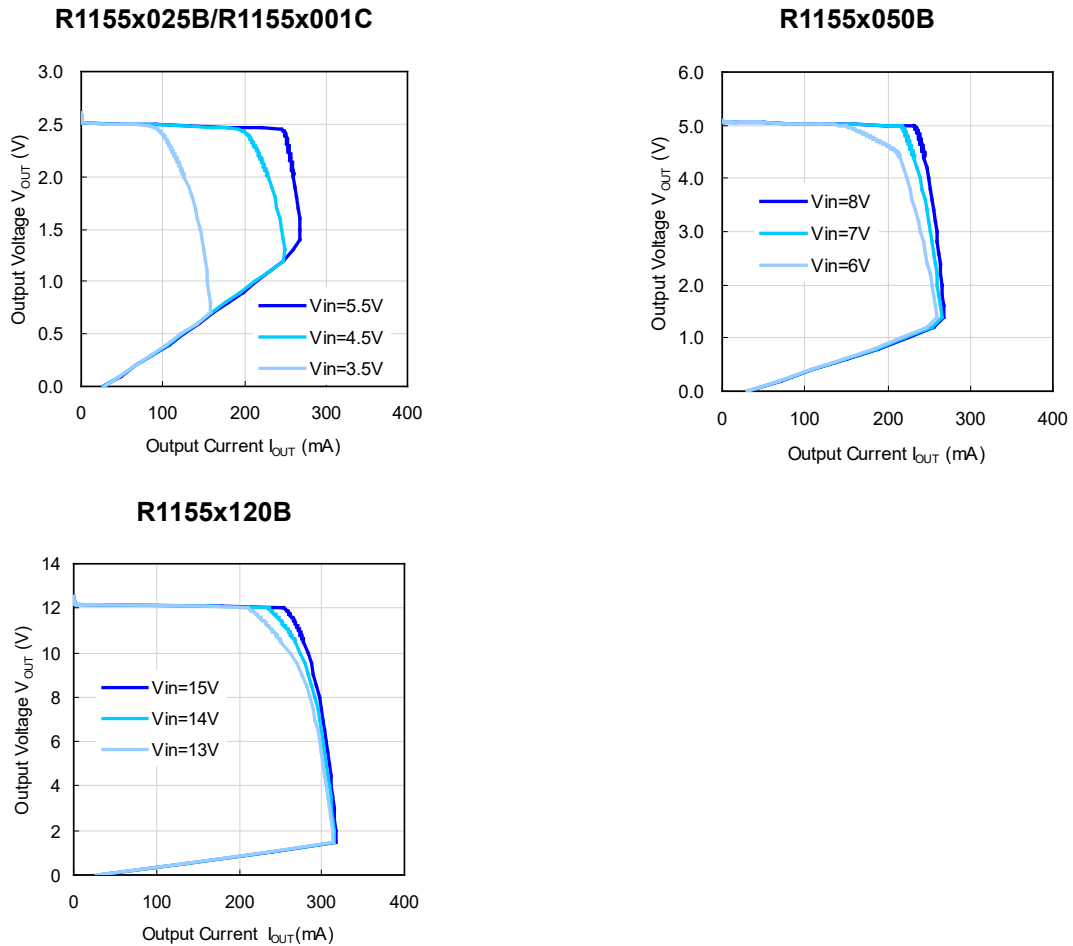

2) Output Voltage vs. Input Voltage ($C_{IN} = 0.1 \mu\text{F}$, $C_{OUT} = 4.7 \mu\text{F}$, $T_a = 25^\circ\text{C}$)

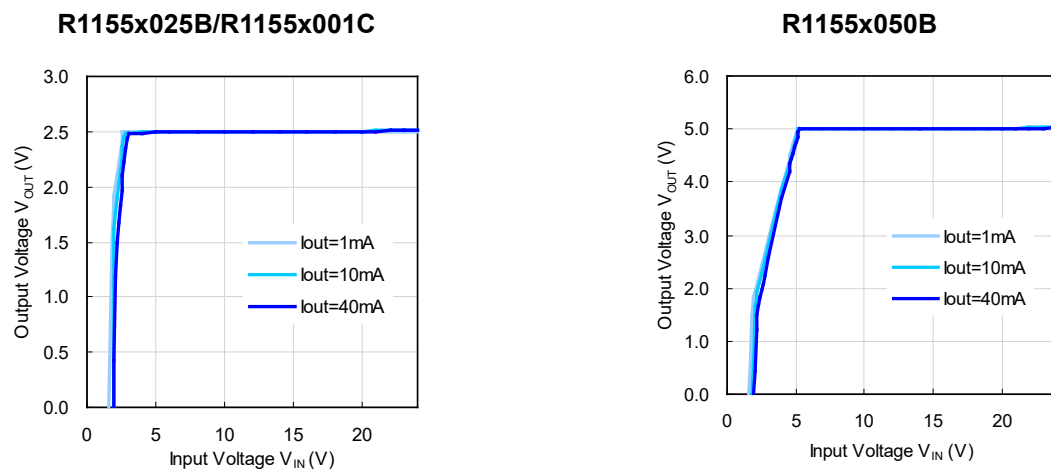

R1155x120B

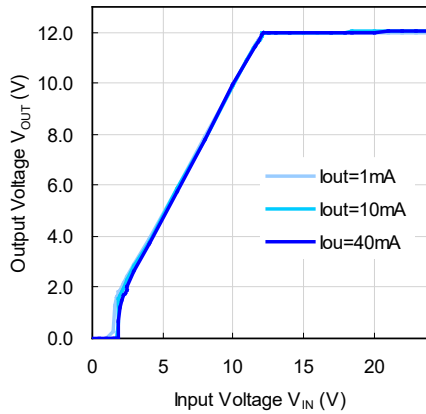

3) Dropout Voltage vs. Output Current ($C_{IN} = 0.1 \mu F$, $C_{OUT} = 4.7 \mu F$)

R1155x025B/R1155x001C

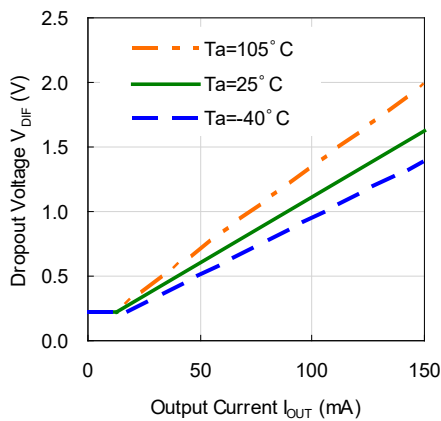

R1155x050B

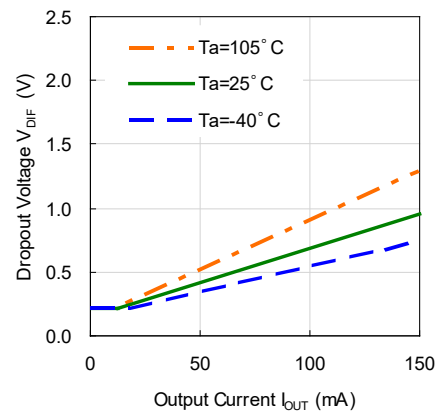

R1155x120B

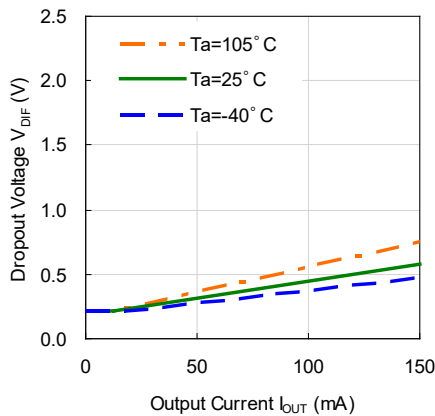

4) Dropout Voltage vs. Set Output Voltage

($C_{IN} = 0.1 \mu F$, $C_{OUT} = 4.7 \mu F$, $T_a = 25^\circ C$)

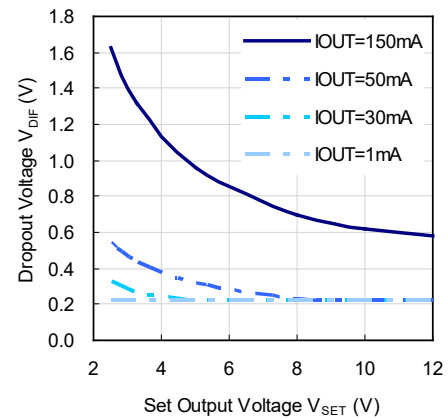

5) Ripple Rejection vs. Frequency ($C_{IN} = \text{none}$, $C_{OUT} = 4.7 \mu\text{F}$, Ripple = $0.2 V_{P-P}$, $T_a = 25^\circ\text{C}$)

R1155x025B

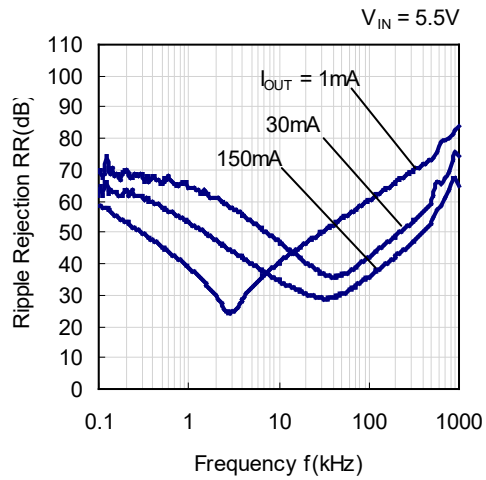

R1155x050B

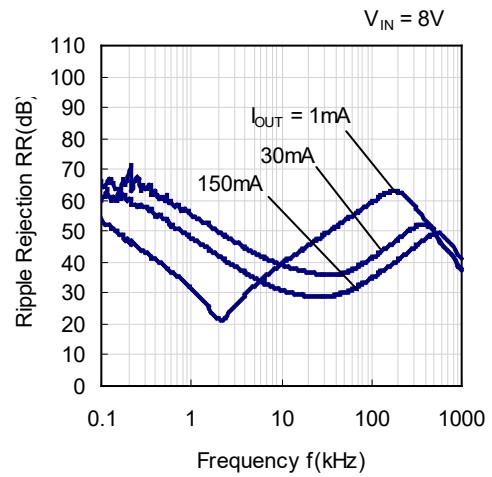

R1155x120B

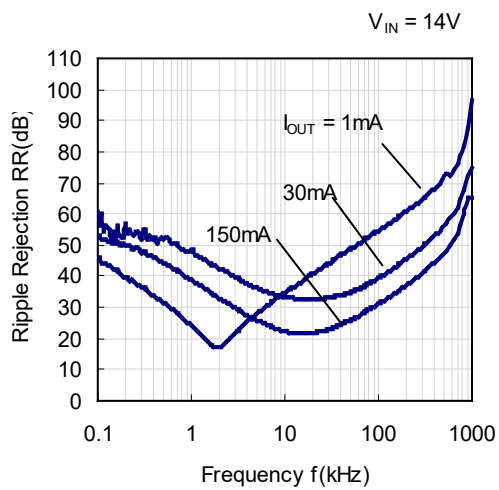

6) Output Voltage vs. Operating Temperature ($C_{IN} = 0.1 \mu F$, $C_{OUT} = 4.7 \mu F$, $T_a = 25^\circ C$, $I_{OUT} = 1 mA$)

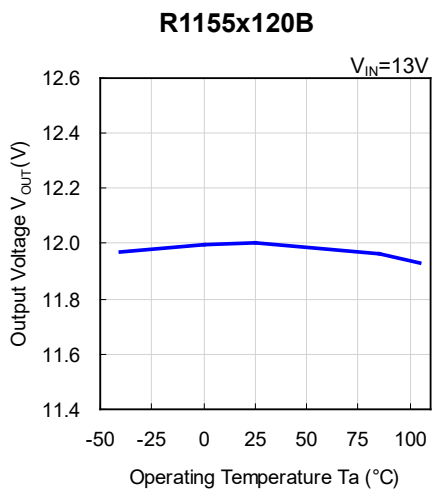
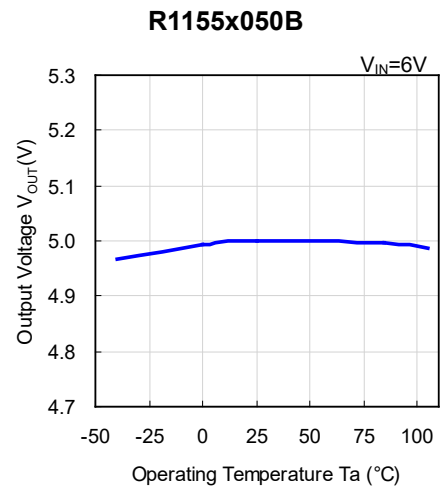
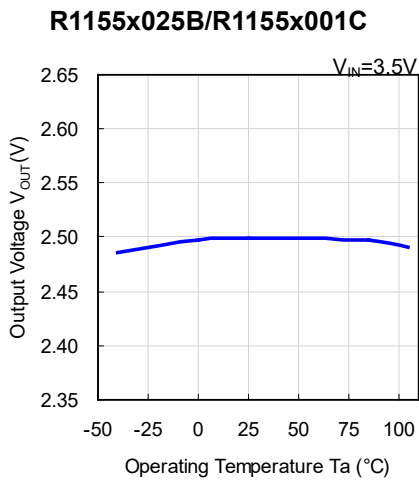

7) Supply Current vs. Input Voltage ($C_{IN} = 0.1 \mu F$, $C_{OUT} = 4.7 \mu F$, $T_a = 25^\circ C$)

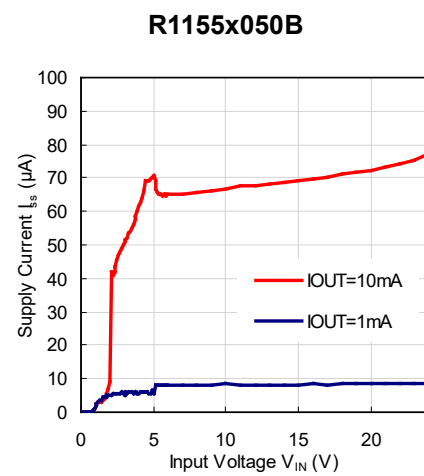
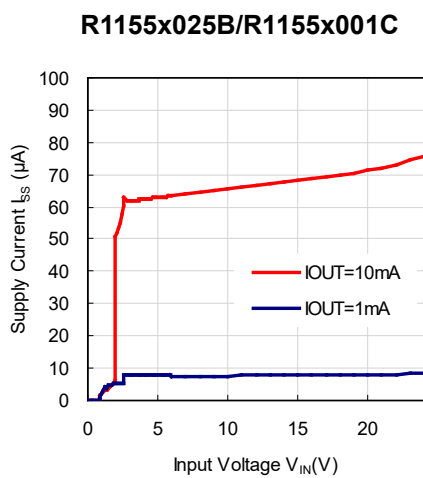

R1155x120B

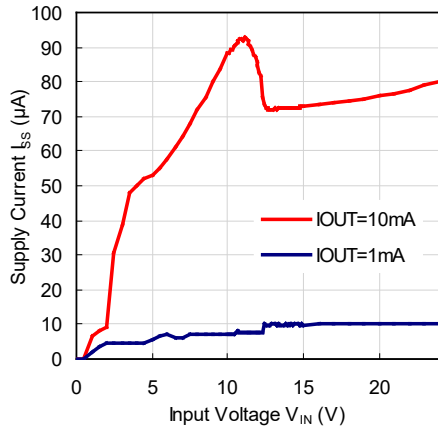

8) Supply Current vs. Operating Temperature ($C_{IN} = 0.1 \mu F$, $C_{OUT} = 4.7 \mu F$)

R1155x025B/R1155x001C

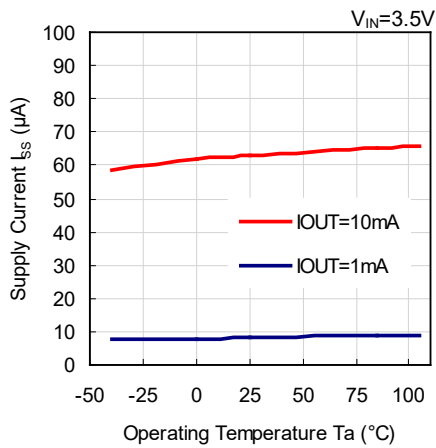

R1155x050B

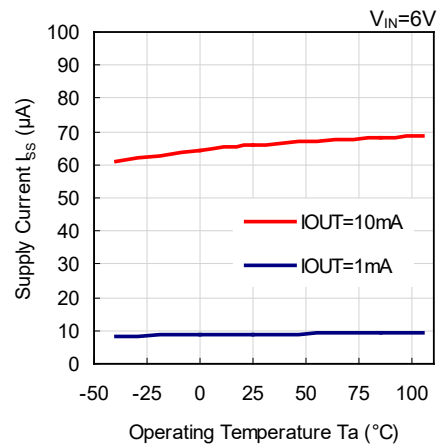

R1155x120B

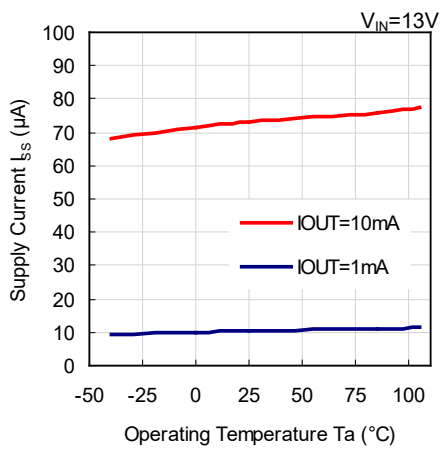

9) Supply Current vs. Output Current ($C_{IN} = 0.1 \mu F$, $C_{OUT} = 4.7 \mu F$, $T_a = 25^\circ C$)

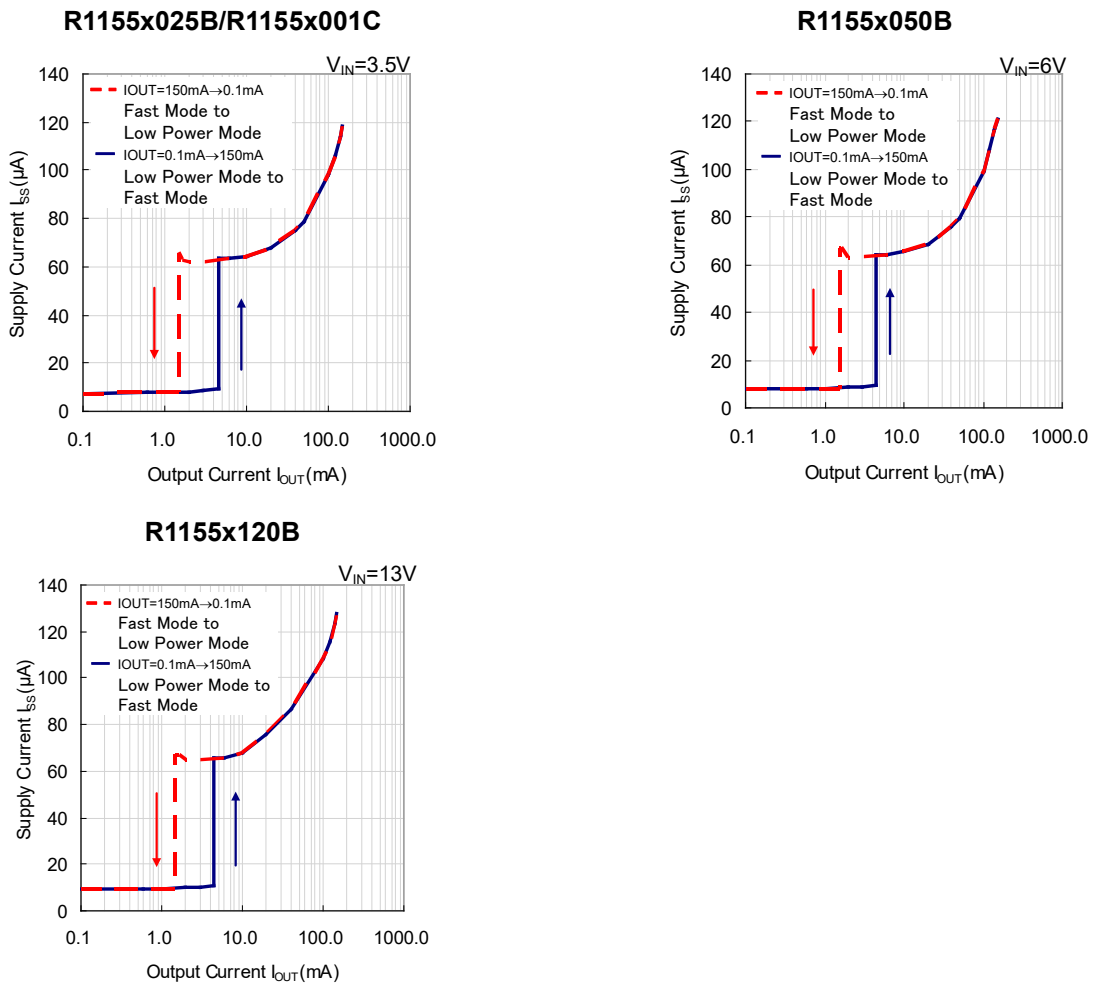

10) Mode Switching Current vs. Operating Temperature ($C_{IN} = 0.1 \mu F$, $C_{OUT} = 4.7 \mu F$)

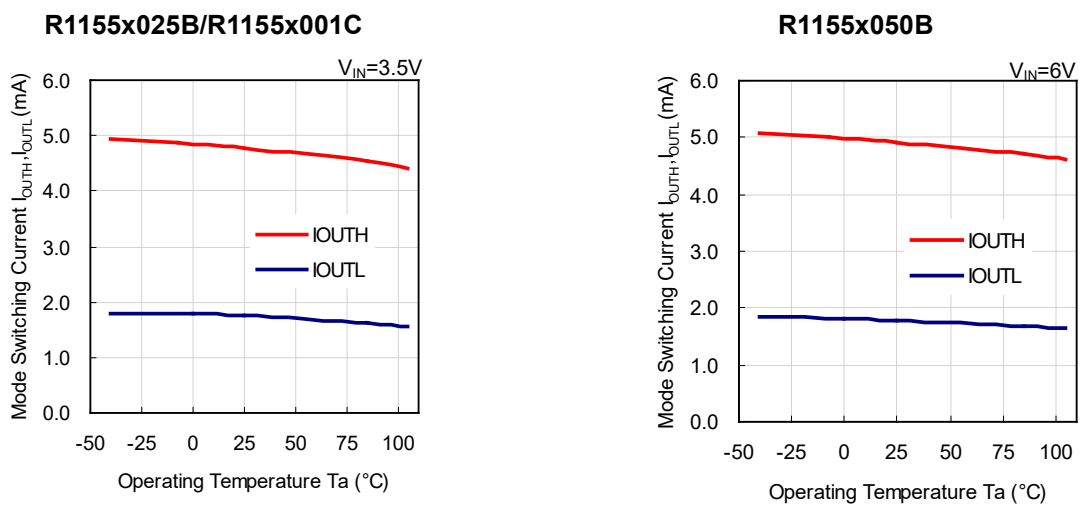

R1155x120B

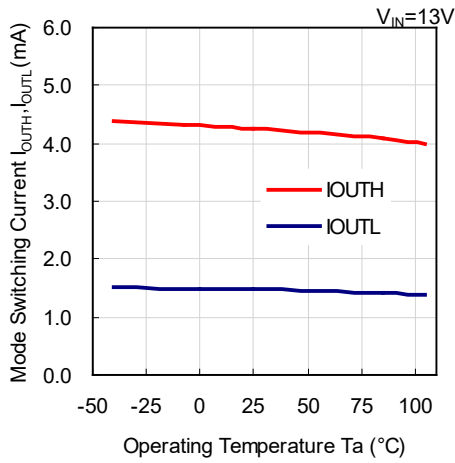

11) Input Transient Response ($C_{OUT} = 4.7 \mu F$, $T_a = 25^\circ C$)

R1155x025B

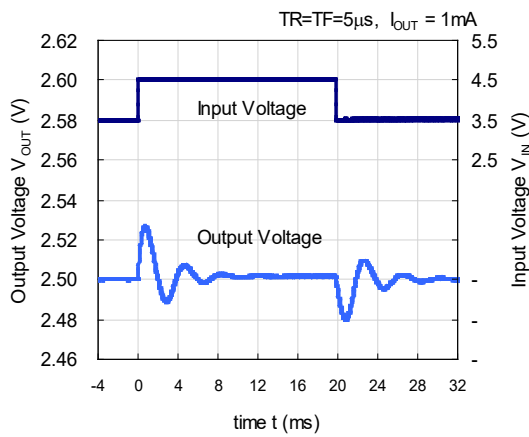

R1155x025B

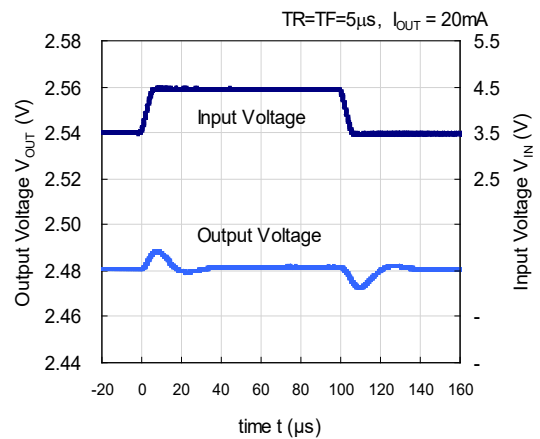

R1155x050B

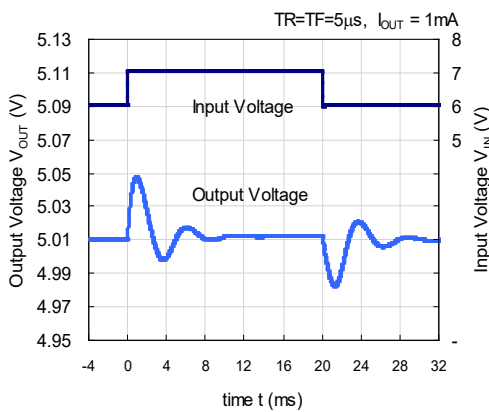

R1155x050B

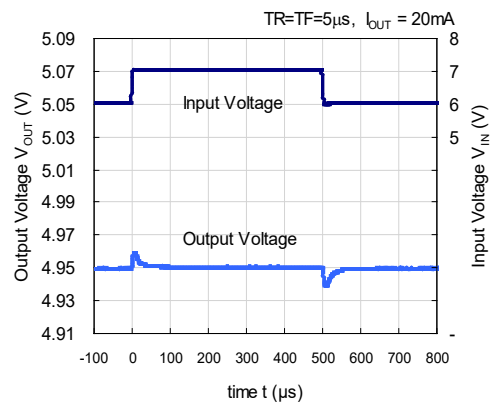

R1155x120B

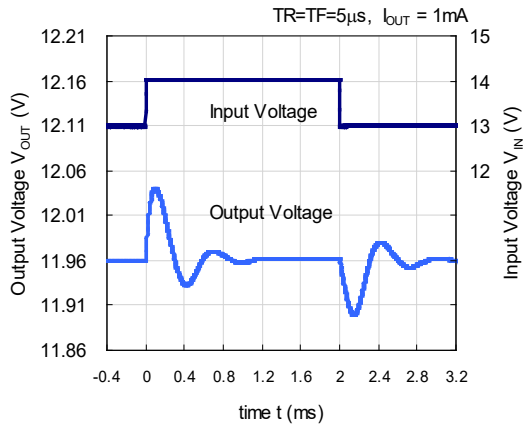

R1155x120B

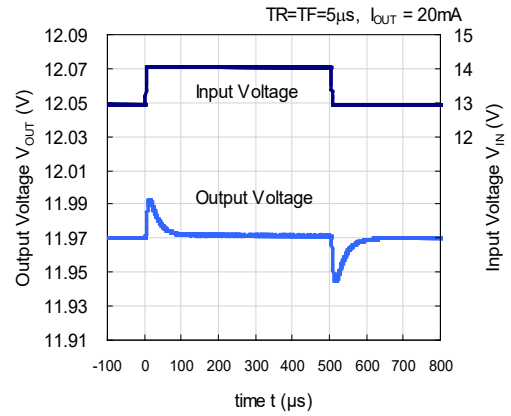

12) Load Transient Response ($C_{OUT} = 4.7 \mu\text{F}$, $T_a = 25^\circ\text{C}$)

R1155x025B

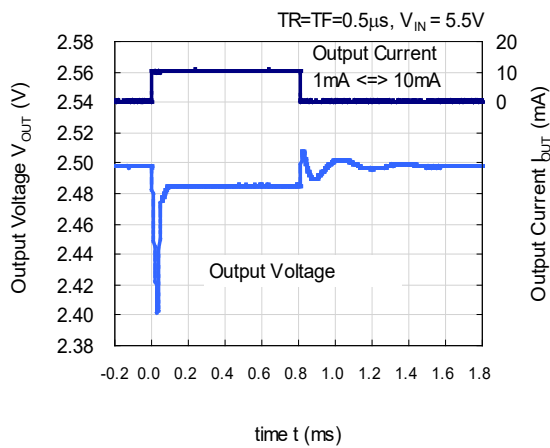

R1155x025B

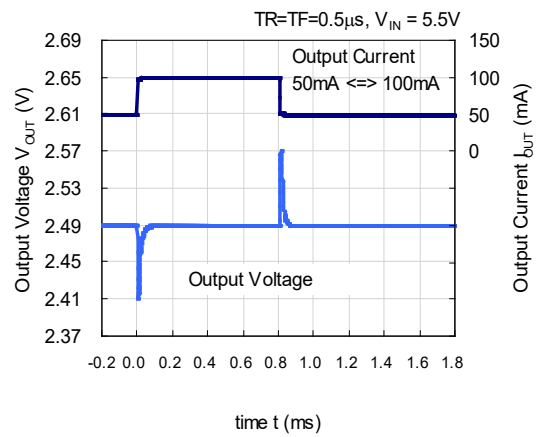

R1155x050B

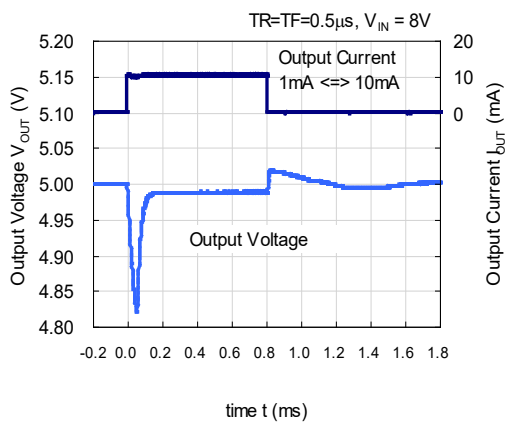

R1155x050B

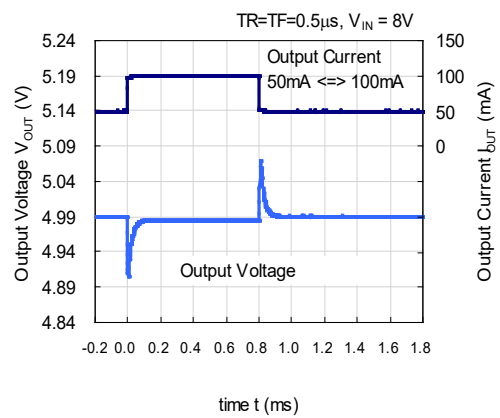

R1155x120B

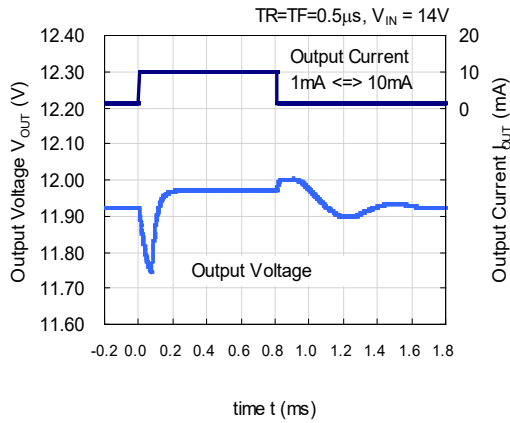

R1155x120B

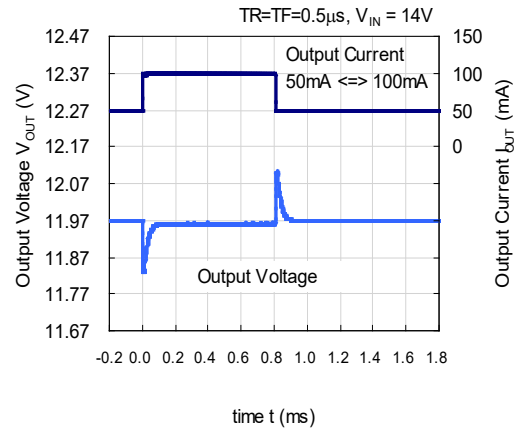

13) CE Input Voltage vs. Output Voltage vs. Inrush Current ($C_{IN} = 0.1 \mu F$, $C_{OUT} = 4.7 \mu F$, $T_a = 25^\circ C$)

R1155x025B

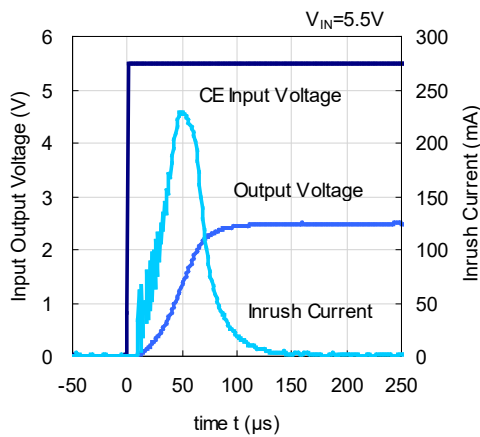

R1155x050B

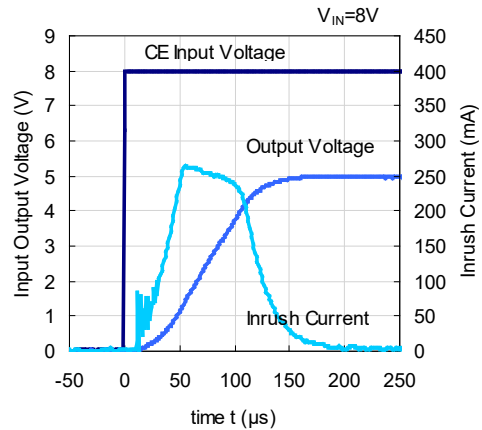

R1155x120B

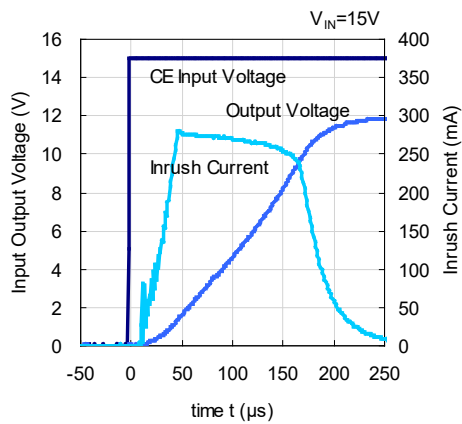

The power dissipation of the package is dependent on PCB material, layout, and environmental conditions. The following measurement conditions are based on JEDEC STD. 51-7.

Measurement Conditions

Item	Measurement Conditions
Environment	Mounting on Board (Wind Velocity = 0 m/s)
Board Material	Glass Cloth Epoxy Plastic (Four-Layer Board)
Board Dimensions	76.2 mm × 114.3 mm × 0.8 mm
Copper Ratio	Outer Layer (First Layer): Less than 95% of 50 mm Square Inner Layers (Second and Third Layers): Approx. 100% of 50 mm Square Outer Layer (Fourth Layer): Approx. 100% of 50 mm Square
Through-holes	φ 0.3 mm × 7 pcs

Measurement Result

(Ta = 25°C, Tjmax = 125°C)

Item	Measurement Result
Power Dissipation	660 mW
Thermal Resistance (θja)	θja = 150°C/W
Thermal Characterization Parameter (ψjt)	ψjt = 51°C/W

θja: Junction-to-Ambient Thermal Resistance

ψjt: Junction-to-Top Thermal Characterization Parameter

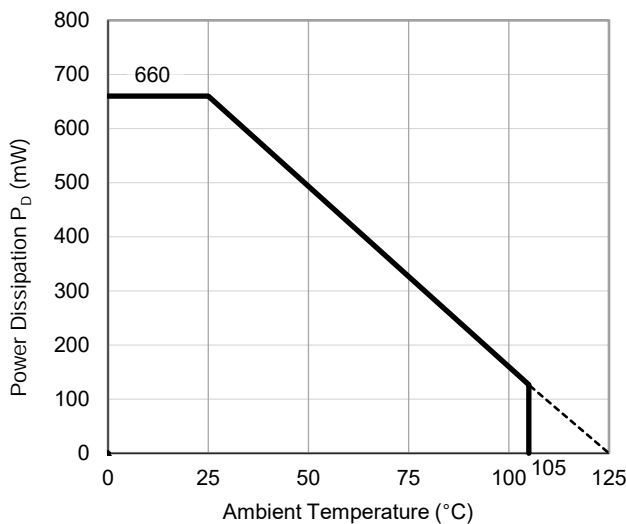

Power Dissipation vs. Ambient Temperature

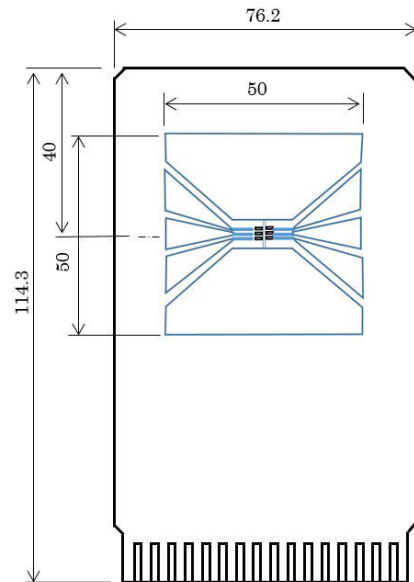

Measurement Board Pattern

①②③: Product Code ... **Refer to the following table.**

④⑤: Lot Number ... Alphanumeric Serial Number

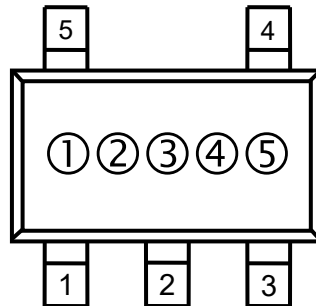

SOT-23-5 Mark Specification

NOTICE

There can be variation in the marking when different AOI (Automated Optical Inspection) equipment is used. In the case of recognizing the marking characteristic with AOI, please contact our sales or our distributor before attempting to use AOI.

R1155NxxxB/ R1155N001C

Product Name	①②③	④⑤
R1155N025B	V25	Lot No.
R1155N026B	V26	Lot No.
R1155N027B	V27	Lot No.
R1155N028B	V28	Lot No.
R1155N029B	V29	Lot No.
R1155N030B	V30	Lot No.
R1155N031B	V31	Lot No.
R1155N032B	V32	Lot No.
R1155N033B	V33	Lot No.
R1155N034B	V34	Lot No.
R1155N035B	V35	Lot No.
R1155N036B	V36	Lot No.
R1155N037B	V37	Lot No.
R1155N038B	V38	Lot No.
R1155N039B	V39	Lot No.
R1155N040B	V40	Lot No.
R1155N041B	V41	Lot No.
R1155N042B	V42	Lot No.
R1155N043B	V43	Lot No.
R1155N044B	V44	Lot No.
R1155N045B	V45	Lot No.
R1155N046B	V46	Lot No.
R1155N047B	V47	Lot No.
R1155N048B	V48	Lot No.
R1155N049B	V49	Lot No.
R1155N050B	V50	Lot No.
R1155N051B	V51	Lot No.
R1155N052B	V52	Lot No.
R1155N053B	V53	Lot No.
R1155N054B	V54	Lot No.
R1155N055B	V55	Lot No.
R1155N056B	V56	Lot No.
R1155N057B	V57	Lot No.
R1155N058B	V58	Lot No.
R1155N059B	V59	Lot No.
R1155N060B	V60	Lot No.
R1155N061B	V61	Lot No.
R1155N062B	V62	Lot No.
R1155N063B	V63	Lot No.
R1155N064B	V64	Lot No.
R1155N065B	V65	Lot No.
R1155N066B	V66	Lot No.
R1155N067B	V67	Lot No.
R1155N068B	V68	Lot No.
R1155N069B	V69	Lot No.
R1155N070B	V70	Lot No.
R1155N071B	V71	Lot No.
R1155N072B	V72	Lot No.
R1155N073B	V73	Lot No.
R1155N074B	V74	Lot No.
R1155N075B	V75	Lot No.

Product Name	①②③	④⑤
R1155N076B	V76	Lot No.
R1155N077B	V77	Lot No.
R1155N078B	V78	Lot No.
R1155N079B	V79	Lot No.
R1155N080B	V80	Lot No.
R1155N081B	V81	Lot No.
R1155N082B	V82	Lot No.
R1155N083B	V83	Lot No.
R1155N084B	V84	Lot No.
R1155N085B	V85	Lot No.
R1155N086B	V86	Lot No.
R1155N087B	V87	Lot No.
R1155N088B	V88	Lot No.
R1155N089B	V89	Lot No.
R1155N090B	V90	Lot No.
R1155N091B	V91	Lot No.
R1155N092B	V92	Lot No.
R1155N093B	V93	Lot No.
R1155N094B	V94	Lot No.
R1155N095B	V95	Lot No.
R1155N096B	V96	Lot No.
R1155N097B	V97	Lot No.
R1155N098B	V98	Lot No.
R1155N099B	V99	Lot No.
R1155N100B	W00	Lot No.
R1155N101B	W01	Lot No.
R1155N102B	W02	Lot No.
R1155N103B	W03	Lot No.
R1155N104B	W04	Lot No.
R1155N105B	W05	Lot No.
R1155N106B	W06	Lot No.
R1155N107B	W07	Lot No.
R1155N108B	W08	Lot No.
R1155N109B	W09	Lot No.
R1155N110B	W10	Lot No.
R1155N111B	W11	Lot No.
R1155N112B	W12	Lot No.
R1155N113B	W13	Lot No.
R1155N114B	W14	Lot No.
R1155N115B	W15	Lot No.
R1155N116B	W16	Lot No.
R1155N117B	W17	Lot No.
R1155N118B	W18	Lot No.
R1155N119B	W19	Lot No.
R1155N120B	W20	Lot No.

Product Name	①②③	④⑤
R1155N001C	U00	Lot No.

The power dissipation of the package is dependent on PCB material, layout, and environmental conditions. The following measurement conditions are based on JEDEC STD. 51-7.

Measurement Conditions

Item	Measurement Conditions
Environment	Mounting on Board (Wind Velocity = 0 m/s)
Board Material	Glass Cloth Epoxy Plastic (Four-Layer Board)
Board Dimensions	76.2 mm × 114.3 mm × 0.8 mm
Copper Ratio	Outer Layer (First Layer): Less than 95% of 50 mm Square Inner Layers (Second and Third Layers): Approx. 100% of 50 mm Square Outer Layer (Fourth Layer): Approx. 100% of 50 mm Square
Through-holes	φ 0.3 mm × 13 pcs

Measurement Result

(Ta = 25°C, Tjmax = 125°C)

Item	Measurement Result
Power Dissipation	2600 mW
Thermal Resistance (θja)	θja = 38°C/W
Thermal Characterization Parameter (ψjt)	ψjt = 13°C/W

θja: Junction-to-Ambient Thermal Resistance

ψjt: Junction-to-Top Thermal Characterization Parameter

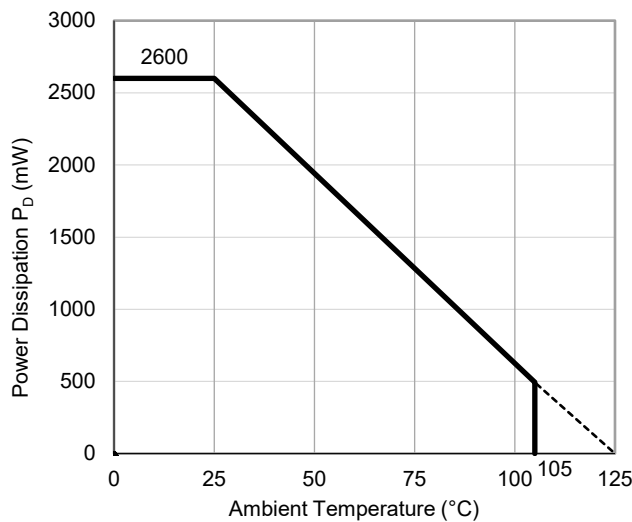

Power Dissipation vs. Ambient Temperature

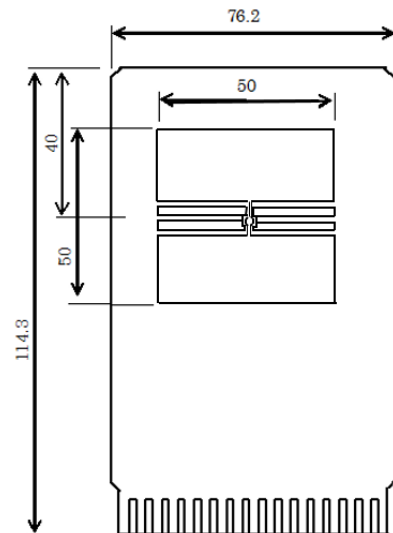

Measurement Board Pattern

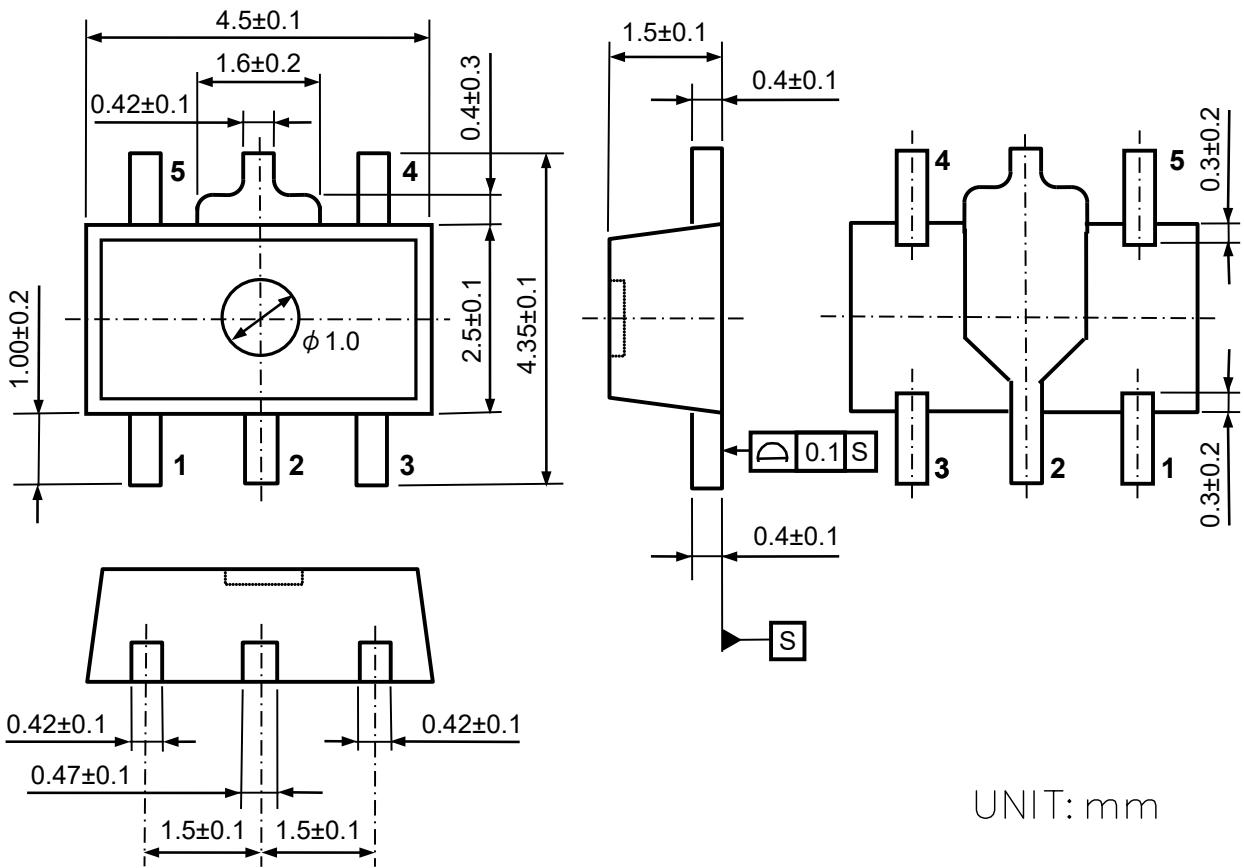

SOT-89-5 Package Dimensions

①②③④: Product Code ... **Refer to the following table.**

⑤⑥: Lot Number ... Alphanumeric Serial Number

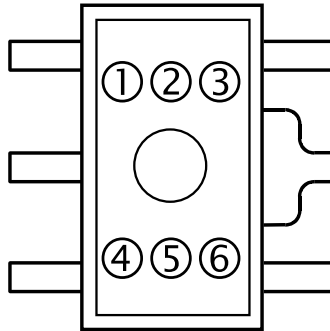

SOT-89-5 Mark Specification

NOTICE

There can be variation in the marking when different AOI (Automated Optical Inspection) equipment is used. In the case of recognizing the marking characteristic with AOI, please contact our sales or our distributor before attempting to use AOI.

MARK SPECIFICATION (Continued)

R1155H

MK-R1155H-E-B

R1155HxxxB/ R1155H001C

Product Name	①②③④	⑤⑥
R1155H025B	E25F	Lot No.
R1155H026B	E26F	Lot No.
R1155H027B	E27F	Lot No.
R1155H028B	E28F	Lot No.
R1155H029B	E29F	Lot No.
R1155H030B	E30F	Lot No.
R1155H031B	E31F	Lot No.
R1155H032B	E32F	Lot No.
R1155H033B	E33F	Lot No.
R1155H034B	E34F	Lot No.
R1155H035B	E35F	Lot No.
R1155H036B	E36F	Lot No.
R1155H037B	E37F	Lot No.
R1155H038B	E38F	Lot No.
R1155H039B	E39F	Lot No.
R1155H040B	E40F	Lot No.
R1155H041B	E41F	Lot No.
R1155H042B	E42F	Lot No.
R1155H043B	E43F	Lot No.
R1155H044B	E44F	Lot No.
R1155H045B	E45F	Lot No.
R1155H046B	E46F	Lot No.
R1155H047B	E47F	Lot No.
R1155H048B	E48F	Lot No.
R1155H049B	E49F	Lot No.
R1155H050B	E50F	Lot No.
R1155H051B	E51F	Lot No.
R1155H052B	E52F	Lot No.
R1155H053B	E53F	Lot No.
R1155H054B	E54F	Lot No.
R1155H055B	E55F	Lot No.
R1155H056B	E56F	Lot No.
R1155H057B	E57F	Lot No.
R1155H058B	E58F	Lot No.
R1155H059B	E59F	Lot No.
R1155H060B	E60F	Lot No.
R1155H061B	E61F	Lot No.
R1155H062B	E62F	Lot No.
R1155H063B	E63F	Lot No.
R1155H064B	E64F	Lot No.
R1155H065B	E65F	Lot No.
R1155H066B	E66F	Lot No.
R1155H067B	E67F	Lot No.
R1155H068B	E68F	Lot No.
R1155H069B	E69F	Lot No.
R1155H070B	E70F	Lot No.
R1155H071B	E71F	Lot No.
R1155H072B	E72F	Lot No.
R1155H073B	E73F	Lot No.
R1155H074B	E74F	Lot No.
R1155H075B	E75F	Lot No.

Product Name	①②③④	⑤⑥
R1155H076B	E76F	Lot No.
R1155H077B	E77F	Lot No.
R1155H078B	E78F	Lot No.
R1155H079B	E79F	Lot No.
R1155H080B	E80F	Lot No.
R1155H081B	E81F	Lot No.
R1155H082B	E82F	Lot No.
R1155H083B	E83F	Lot No.
R1155H084B	E84F	Lot No.
R1155H085B	E85F	Lot No.
R1155H086B	E86F	Lot No.
R1155H087B	E87F	Lot No.
R1155H088B	E88F	Lot No.
R1155H089B	E89F	Lot No.
R1155H090B	E90F	Lot No.
R1155H091B	E91F	Lot No.
R1155H092B	E92F	Lot No.
R1155H093B	E93F	Lot No.
R1155H094B	E94F	Lot No.
R1155H095B	E95F	Lot No.
R1155H096B	E96F	Lot No.
R1155H097B	E97F	Lot No.
R1155H098B	E98F	Lot No.
R1155H099B	E99F	Lot No.
R1155H100B	F00F	Lot No.
R1155H101B	F01F	Lot No.
R1155H102B	F02F	Lot No.
R1155H103B	F03F	Lot No.
R1155H104B	F04F	Lot No.
R1155H105B	F05F	Lot No.
R1155H106B	F06F	Lot No.
R1155H107B	F07F	Lot No.
R1155H108B	F08F	Lot No.
R1155H109B	F09F	Lot No.
R1155H110B	F10F	Lot No.
R1155H111B	F11F	Lot No.
R1155H112B	F12F	Lot No.
R1155H113B	F13F	Lot No.
R1155H114B	F14F	Lot No.
R1155H115B	F15F	Lot No.
R1155H116B	F16F	Lot No.
R1155H117B	F17F	Lot No.
R1155H118B	F18F	Lot No.
R1155H119B	F19F	Lot No.
R1155H120B	F20F	Lot No.

Product Name	①②③④	⑤⑥
R1155H001C	G00G	Lot No.

1. The products and the product specifications described in this document are subject to change or discontinuation of production without notice for reasons such as improvement. Therefore, before deciding to use the products, please refer to our sales representatives for the latest information thereon.
2. The materials in this document may not be copied or otherwise reproduced in whole or in part without the prior written consent of us.
3. This product and any technical information relating thereto are subject to complementary export controls (so-called KNOW controls) under the Foreign Exchange and Foreign Trade Law, and related politics ministerial ordinance of the law. (Note that the complementary export controls are inapplicable to any application-specific products, except rockets and pilotless aircraft, that are insusceptible to design or program changes.) Accordingly, when exporting or carrying abroad this product, follow the Foreign Exchange and Foreign Trade Control Law and its related regulations with respect to the complementary export controls.
4. The technical information described in this document shows typical characteristics and example application circuits for the products. The release of such information is not to be construed as a warranty of or a grant of license under our or any third party's intellectual property rights or any other rights.
5. The products listed in this document are intended and designed for use as general electronic components in standard applications (office equipment, telecommunication equipment, measuring instruments, consumer electronic products, amusement equipment etc.). Those customers intending to use a product in an application requiring extreme quality and reliability, for example, in a highly specific application where the failure or misoperation of the product could result in human injury or death should first contact us.
 - Aerospace Equipment
 - Equipment Used in the Deep Sea
 - Power Generator Control Equipment (nuclear, steam, hydraulic, etc.)
 - Life Maintenance Medical Equipment
 - Fire Alarms / Intruder Detectors
 - Vehicle Control Equipment (automotive, airplane, railroad, ship, etc.)
 - Various Safety Devices
 - Traffic control system
 - Combustion equipment

In case your company desires to use this product for any applications other than general electronic equipment mentioned above, make sure to contact our company in advance. Note that the important requirements mentioned in this section are not applicable to cases where operation requirements such as application conditions are confirmed by our company in writing after consultation with your company.

6. We are making our continuous effort to improve the quality and reliability of our products, but semiconductor products are likely to fail with certain probability. In order to prevent any injury to persons or damages to property resulting from such failure, customers should be careful enough to incorporate safety measures in their design, such as redundancy feature, fire containment feature and fail-safe feature. We do not assume any liability or responsibility for any loss or damage arising from misuse or inappropriate use of the products.
7. The products have been designed and tested to function within controlled environmental conditions. Do not use products under conditions that deviate from methods or applications specified in this datasheet. Failure to employ the products in the proper applications can lead to deterioration, destruction or failure of the products. We shall not be responsible for any bodily injury, fires or accident, property damage or any consequential damages resulting from misuse or misapplication of the products.
8. **Quality Warranty**
 - 8-1. **Quality Warranty Period**

In the case of a product purchased through an authorized distributor or directly from us, the warranty period for this product shall be one (1) year after delivery to your company. For defective products that occurred during this period, we will take the quality warranty measures described in section 8-2. However, if there is an agreement on the warranty period in the basic transaction agreement, quality assurance agreement, delivery specifications, etc., it shall be followed.
 - 8-2. **Quality Warranty Remedies**

When it has been proved defective due to manufacturing factors as a result of defect analysis by us, we will either deliver a substitute for the defective product or refund the purchase price of the defective product.
Note that such delivery or refund is sole and exclusive remedies to your company for the defective product.
 - 8-3. **Remedies after Quality Warranty Period**

With respect to any defect of this product found after the quality warranty period, the defect will be analyzed by us. On the basis of the defect analysis results, the scope and amounts of damage shall be determined by mutual agreement of both parties. Then we will deal with upper limit in Section 8-2. This provision is not intended to limit any legal rights of your company.
9. Anti-radiation design is not implemented in the products described in this document.
10. The X-ray exposure can influence functions and characteristics of the products. Confirm the product functions and characteristics in the evaluation stage.
11. WLCSP products should be used in light shielded environments. The light exposure can influence functions and characteristics of the products under operation or storage.
12. Warning for handling Gallium and Arsenic (GaAs) products (Applying to GaAs MMIC, Photo Reflector). These products use Gallium (Ga) and Arsenic (As) which are specified as poisonous chemicals by law. For the prevention of a hazard, do not burn, destroy, or process chemically to make them as gas or power. When the product is disposed of, please follow the related regulation and do not mix this with general industrial waste or household waste.
13. Please contact our sales representatives should you have any questions or comments concerning the products or the technical information.



Nisshinbo Micro Devices Inc.

Official website

<https://www.nisshinbo-microdevices.co.jp/en/>

Purchase information

<https://www.nisshinbo-microdevices.co.jp/en/buy/>

X-ON Electronics

Largest Supplier of Electrical and Electronic Components

Click to view similar products for [LDO Voltage Regulators](#) category:

Click to view products by [Nisshinbo](#) manufacturer:

Other Similar products are found below :

[AP7363-SP-13](#) [NCV8664CST33T3G](#) [L79M05TL-E](#) [AP7362-HA-7](#) [PT7M8202B12TA5EX](#) [TCR3DF185,LM\(CT](#) [TLF4949EJ](#)
[NCP4687DH15T1G](#) [NCV8703MX30TCG](#) [LP2951CN](#) [NCV4269CPD50R2G](#) [AP7315-25W5-7](#) [NCV47411PAAJR2G](#) [AP2111H-1.2TRG1](#)
[ZLDO1117QK50TC](#) [AZ1117ID-ADJTRG1](#) [NCV4263-2CPD50R2G](#) [NCP706ABMX300TAG](#) [NCP114BMX075TCG](#) [MC33269T-3.5G](#)
[TLE4471GXT](#) [AP7315-33SA-7](#) [NCV4266-2CST33T3G](#) [NCP715SQ15T2G](#) [NCV8623MN-50R2G](#) [NCV563SQ18T1G](#) [NCV8664CDT33RKG](#)
[NCV4299CD250R2G](#) [NCP715MX30TBG](#) [NCV8702MX25TCG](#) [TLE7270-2E](#) [NCV562SQ25T1G](#) [AP2213D-3.3TRG1](#) [AP2202K-2.6TRE1](#)
[NCV8170BMX300TCG](#) [NCV8152MX300180TCG](#) [NCP700CMT45TBG](#) [AP7315-33W5-7](#) [NCP154MX180300TAG](#) [AP2113AMTR-G1](#)
[NJW4104U2-33A-TE1](#) [MP2013AGG-5-P](#) [NCV8775CDT50RKG](#) [NJM2878F3-45-TE1](#) [S-19214B00A-V5T2U7](#) [S-19214B50A-V5T2U7](#) [S-](#)
[19213B50A-V5T2U7](#) [S-19214BC0A-E8T1U7*1](#) [S-19213B00A-V5T2U7](#) [S-19213B33A-V5T2U7](#)