

## Super low on resistance/Low voltage LDO

NO.EA-123-220509

### OUTLINE

The R1173x Series are CMOS-based positive voltage regulator ICs. The R1173x Series have features of super low dropout, 1A output current capability, and -3mV typical load regulation at 1A. Even the output voltage is set at 1.5V, on resistance of internal FET is typically 0.32Ω. Therefore, applications that require a large current at small dropout are suitable for the R1173x series. Low input voltage is acceptable and low output voltage can be set. The minimum input voltage is 1.4V, and the lowest set output voltage is 0.8V. Each of these ICs consists of a voltage reference unit, an error amplifier, resistor net for setting output voltage, a current limit circuit at over-current, a chip enable circuit, a thermal-shutdown circuit, and so on. A stand-by mode with ultra low consumption current can be realized with the chip enable pin. The output voltage types of R1173 are fixed one in the IC and adjustable one (R1173x001x).

Since the packages for these ICs are the SOT-89-5 package, HSON-6, or HSOP-6J, high density mounting of the ICs on boards is possible.

### FEATURES

- Output Current ..... 1A
- Supply Current ..... Typ. 60μA
- Standby Current ..... Typ. 0.1μA
- Input Voltage Range ..... 1.4V to 6.0V
- Output Voltage Range ..... 0.8V to 5.0V (0.1V steps) (R1173xxx1)  
1.0V to V<sub>IN</sub> (R1173x001)  
(For other voltages, please refer to MARK INFORMATIONS.)
- Dropout Voltage ..... Typ. 0.32V (V<sub>OUT</sub>=1.5V, I<sub>OUT</sub>=1A)  
Typ. 0.18V (V<sub>OUT</sub>=2.8V, I<sub>OUT</sub>=1A)
- Ripple Rejection ..... Typ. 70dB (V<sub>OUT</sub>=2.8V)
- Output Voltage Accuracy ..... ±2.0%
- Temperature-drift Coefficient of Output Voltage ..... Typ. ±100ppm/°C
- Line Regulation ..... Typ. 0.05%/V
- Load Regulation ..... Typ. -2mV (I<sub>OUT</sub>=300mA)  
Typ. -3mV (I<sub>OUT</sub>=1A)
- Packages ..... SOT-89-5, HSON-6, HSOP-6J
- Low inrush current at turning-on ..... Typ. 500mA
- Built-in Thermal Shutdown Circuit
- Built-in Current Limit Circuit ..... Typ. 250mA
- Output capacitors ..... C<sub>IN</sub>=Ceramic 4.7μF  
C<sub>OUT</sub>=Tantalum 4.7μF (V<sub>OUT</sub><1.0V)  
C<sub>OUT</sub>=Ceramic 4.7μF (V<sub>OUT</sub> ≥ 1.0V)

### APPLICATIONS

- Local Power source for Notebook PC.
- Local Power source for portable communication equipments, cameras, and videos.
- Local Power source for home appliances.

**BLOCK DIAGRAMS**

**R1173xxx1B**

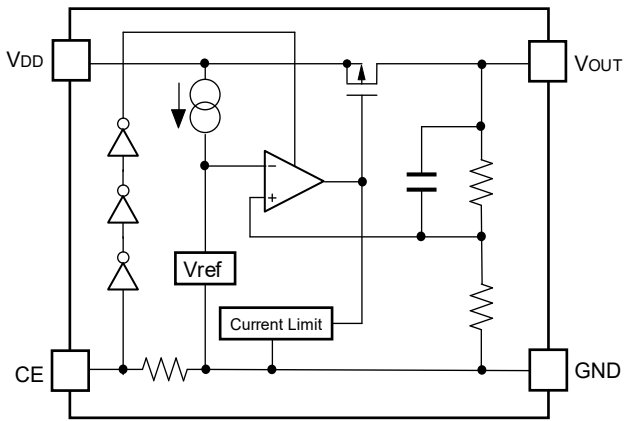

**R1173xxx1D**

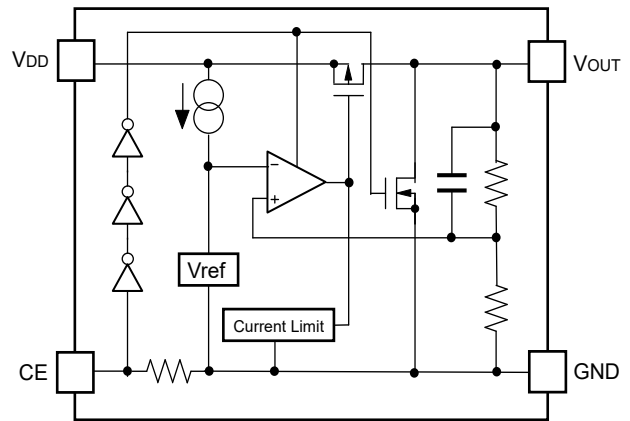

**R1173x001B**

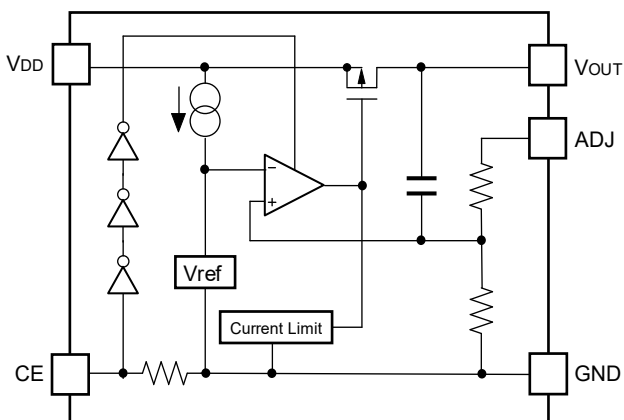

**R1173x001D**

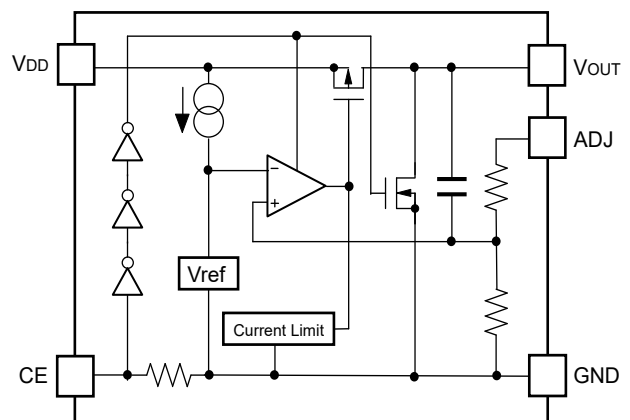

## SELECTION GUIDE

The output voltage, auto discharge function, package for the ICs can be selected at the user's request.

Product Name	Package	Quantity per Reel	Pb Free	Halogen Free
R1173Dxx1*-TR-FE	HSOP-6	3,000 pcs	Yes	Yes
R1173Hxx1*-T1-FE	SOT-89-5	1,000 pcs	Yes	Yes
R1173Sxx1*-E2-FE	HSOP-6J	1,000 pcs	Yes	Yes

xx: The output voltage can be designated in the range from 0.8V(08) to 5.0V(50) in 0.1V steps.

External Setting Type: 00 (ADJ pin voltage is fixed at 1.0V.)

(For other voltages, please refer to MARK INFORMATIONS.)

\* : The auto discharge function at off state are options as follows.

(B) "H" active, without auto discharge function at off state

(D) "H" active, with auto discharge function at off state

## PIN CONFIGURATIONS

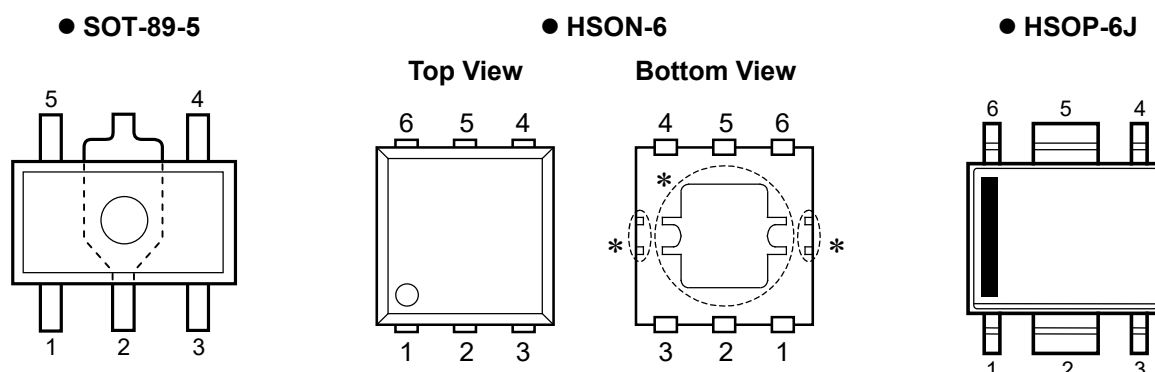

## PIN DESCRIPTIONS

### ●SOT-89-5

Pin No.	Symbol	Description
1	ADJ	ADJUST Pin (R1173H001x)
	NC	No Connection (R1173Hxx1x)
2	GND	Ground Pin
3	CE	Chip Enable Pin ("H" Active)
4	V <sub>DD</sub>	Input Pin
5	V <sub>OUT</sub>	Output Pin

### ●HSON-6

Pin No.	Symbol	Description
1	V <sub>OUT</sub> *1	Output Pin
2	V <sub>OUT</sub> *1	Output Pin
3	ADJ	ADJUST Pin (R1173D001x)
	NC	No Connection (R1173Dxx1x)
4	GND	Ground Pin
5	CE	Chip Enable Pin ("H" Active)
6	V <sub>DD</sub>	Input Pin

\*) Tab and tab suspension leads in the  parts are GND level.

(They are connected to the reverse side of the IC.)

The tab is better to be connected to the GND, but leaving it open is also acceptable.

The tab suspension leads should be open and do not connect to other wires or land patterns.

\*1) The V<sub>OUT</sub> pin must be wired together when it is mounted on board.

## ●HSOP-6J

Pin No.	Symbol	Description
1	V <sub>OUT</sub>	Output Pin
2	GND*1	Ground Pin
3	ADJ	ADJUST Pin (R1173S001x)
	NC	No Connection (R1173Sxx1x)
4	CE	Chip Enable Pin ("H" Active)
5	GND*1	Ground Pin
6	V <sub>DD</sub>	Input Pin

\*1) The GND pin must be wired together when it is mounted on board.

## ABSOLUTE MAXIMUM RATINGS

Symbol	Item	Rating	Unit
V <sub>IN</sub>	Input Voltage	6.5	V
V <sub>CE</sub>	Input Voltage (CE Input Pin)	-0.3 to 6.5	V
V <sub>OUT</sub>	Output Voltage	-0.3 to V <sub>IN</sub> +0.3	V
P <sub>D</sub>	Power Dissipation (SOT-89-5)*	900	mW
	Power Dissipation (HSOP-6)*	900	
	Power Dissipation (HSOP-6J)*	1700	
T <sub>opt</sub>	Operating Temperature	-40 to 85	°C
T <sub>stg</sub>	Storage Temperature	-55 to 125	°C

\*) For Power Dissipation, please refer to PACKAGE INFORMATION.

### ABSOLUTE MAXIMUM RATINGS

Electronic and mechanical stress momentarily exceeded absolute maximum ratings may cause the permanent damages and may degrade the life time and safety for both device and system using the device in the field.

The functional operation at or over these absolute maximum ratings is not assured.

### RECOMMENDED OPERATING CONDITIONS (ELECTRICAL CHARACTERISTICS)

All of electronic equipment should be designed that the mounted semiconductor devices operate within the recommended operating conditions. The semiconductor devices cannot operate normally over the recommended operating conditions, even if when they are used over such conditions by momentary electronic noise or surge. And the semiconductor devices may receive serious damage when they continue to operate over the recommended operating conditions.

## ELECTRICAL CHARACTERISTICS

### • R1173xxxxB/D (Fixed Output Voltage Type)

T<sub>opt</sub>=25°C

Symbol	Item	Conditions	Min.	Typ.	Max.	Unit	
V <sub>IN</sub>	Input Voltage		1.4		6.0	V	
I <sub>SS</sub>	Supply Current	V <sub>IN</sub> -V <sub>OUT</sub> =1.0V, V <sub>CE</sub> =V <sub>IN</sub> , I <sub>OUT</sub> =0A		60	100	μA	
I <sub>standby</sub>	Standby Current	V <sub>IN</sub> = 6.0V, V <sub>CE</sub> =0V		0.1	1.0	μA	
V <sub>OUT</sub>	Output voltage	V <sub>IN</sub> -V <sub>OUT</sub> =1.0V I <sub>OUT</sub> =100mA	V <sub>OUT</sub> >1.5V	×0.98	×1.02	V	
			V <sub>OUT</sub> ≤ 1.5V	-30	+30	mV	
ΔV <sub>OUT</sub> / ΔI <sub>OUT</sub>	Load regulation	V <sub>IN</sub> -V <sub>OUT</sub> =0.3V, 1mA ≤ I <sub>OUT</sub> ≤ 300mA If V <sub>OUT</sub> ≤ 1.1V, then V <sub>IN</sub> =1.4V		-15	-2	15	mV
		V <sub>IN</sub> -V <sub>OUT</sub> =0.3V, 1mA ≤ I <sub>OUT</sub> ≤ 1A If V <sub>OUT</sub> ≤ 1.1V, then V <sub>IN</sub> =1.7V			-3		
V <sub>DIF</sub>	Dropout Voltage	Refer to the following table					
ΔV <sub>OUT</sub> / ΔV <sub>IN</sub>	Line regulation	I <sub>OUT</sub> =100mA, V <sub>OUT</sub> +0.5V ≤ V <sub>IN</sub> ≤ 6.0V If V <sub>OUT</sub> ≤ 0.9V, 1.4V ≤ V <sub>IN</sub> ≤ 6.0V		0.05	0.20	%/V	
RR	Ripple Rejection	f=1kHz (V <sub>OUT</sub> ≤ 4.0V) f=1kHz (V <sub>OUT</sub> >4.0V) Ripple 0.5Vp-p, V <sub>IN</sub> -V <sub>OUT</sub> =1.0V, I <sub>OUT</sub> =100mA If V <sub>OUT</sub> ≤ 1.2V, V <sub>IN</sub> -V <sub>OUT</sub> =1.5V, I <sub>OUT</sub> =100mA		70 60		dB	
ΔV <sub>OUT</sub> / ΔT <sub>opt</sub>	Output Voltage Temperature Coefficient	I <sub>OUT</sub> =100mA, -40°C ≤ T <sub>opt</sub> ≤ 85°C		±100		ppm/ °C	
I <sub>LIM</sub>	Output Current	V <sub>IN</sub> -V <sub>OUT</sub> =1.0V	1			A	
I <sub>SC</sub>	Short Current Limit	V <sub>OUT</sub> =0V		250		mA	
R <sub>PD</sub>	Pull-down resistance for CE pin		1.9	5.0	15.0	MΩ	
V <sub>CEH</sub>	CE Input Voltage "H"		1.0		6.0	V	
V <sub>CEL</sub>	CE Input Voltage "L"		0		0.4	V	
T <sub>TSD</sub>	Thermal Shutdown Detector Threshold Temperature	Junction Temperature		150		°C	
T <sub>TSR</sub>	Thermal Shutdown Released Temperature	Junction Temperature		120		°C	
en	Output Noise	BW=10Hz to 100kHz		30		μVrms	

### • Dropout Voltage by Output Voltage

T<sub>opt</sub>=25°C

Output Voltage V <sub>OUT</sub> (V)	Dropout Voltage V <sub>DIF</sub> (V)		
	I <sub>OUT</sub> =300mA		I <sub>OUT</sub> =1A
	Typ.	Max.	Typ.
0.8 ≤ V <sub>OUT</sub> < 0.9	0.33	0.57	0.72
0.9 ≤ V <sub>OUT</sub> < 1.0	0.22	0.47	0.64
1.0 ≤ V <sub>OUT</sub> < 1.5	0.18	0.32	0.56
1.5 ≤ V <sub>OUT</sub> < 2.6	0.10	0.15	0.32
2.6 ≤ V <sub>OUT</sub>	0.05	0.10	0.18

• R1173x001B/D (Adjustable Output Voltage Type)

T<sub>opt</sub>=25°C

Symbol	Item	Conditions	Min.	Typ.	Max.	Unit
V <sub>IN</sub>	Input Voltage		1.4		6.0	V
I <sub>SS</sub>	Supply Current	V <sub>OUT</sub> =V <sub>ADJ</sub> , V <sub>IN</sub> =2.0, V <sub>CE</sub> =V <sub>IN</sub>		60	100	μA
I <sub>standby</sub>	Standby Current	V <sub>IN</sub> =6.0V, V <sub>CE</sub> =0V		0.1	1.0	μA
V <sub>OUT</sub>	Reference Voltage for Adjustable Voltage Regulator	V <sub>OUT</sub> =V <sub>ADJ</sub> , V <sub>IN</sub> =2.0V I <sub>OUT</sub> =100mA	0.970	1.000	1.030	V
RV <sub>OUT</sub>	Output Voltage Range		1.0		V <sub>IN</sub>	V
ΔV <sub>OUT</sub> / ΔI <sub>OUT</sub>	Load regulation	V <sub>IN</sub> =1.4V 1mA ≤ I <sub>OUT</sub> ≤ 300mA	-15	-2	15	mV
		V <sub>IN</sub> =1.7V 1mA ≤ I <sub>OUT</sub> ≤ 1A		-3		
V <sub>DIF</sub>	Dropout Voltage	V <sub>OUT</sub> =V <sub>ADJ</sub> I <sub>OUT</sub> =300mA		0.18	0.32	V
			I <sub>OUT</sub> =1A		0.56	
ΔV <sub>OUT</sub> / ΔV <sub>IN</sub>	Line regulation	V <sub>OUT</sub> =V <sub>ADJ</sub> , I <sub>OUT</sub> =100mA 1.5V ≤ V <sub>IN</sub> ≤ 6.0V		0.05	0.20	%/V
RR	Ripple Rejection	f=1kHz Ripple 0.5Vp-p, V <sub>OUT</sub> =V <sub>ADJ</sub> , V <sub>IN</sub> =2.5V I <sub>OUT</sub> =100mA		70		dB
ΔV <sub>OUT</sub> / ΔT <sub>opt</sub>	Output Voltage Temperature Coefficient	I <sub>OUT</sub> =100mA -40°C ≤ T <sub>opt</sub> ≤ 85°C		±100		ppm/°C
I <sub>LIM</sub>	Output Current	V <sub>OUT</sub> =V <sub>ADJ</sub> , V <sub>IN</sub> =2.0	1			A
I <sub>SC</sub>	Short Current Limit	V <sub>OUT</sub> =V <sub>ADJ</sub> =0V		250		mA
R <sub>PD</sub>	Pull-down resistance for CE pin		1.9	5.0	15.0	MΩ
V <sub>CEH</sub>	CE Input Voltage "H"		1.0		6.0	V
V <sub>CEL</sub>	CE Input Voltage "L"		0		0.4	V
T <sub>TSD</sub>	Thermal Shutdown Detector Threshold Temperature	Junction Temperature		150		°C
T <sub>TSR</sub>	Thermal Shutdown Released Temperature	Junction Temperature		120		°C
en	Output Noise	BW=10Hz to 100kHz		30		μVrms

## Technical Notes on External Components and Typical Application

(Refer to the example of typical application)

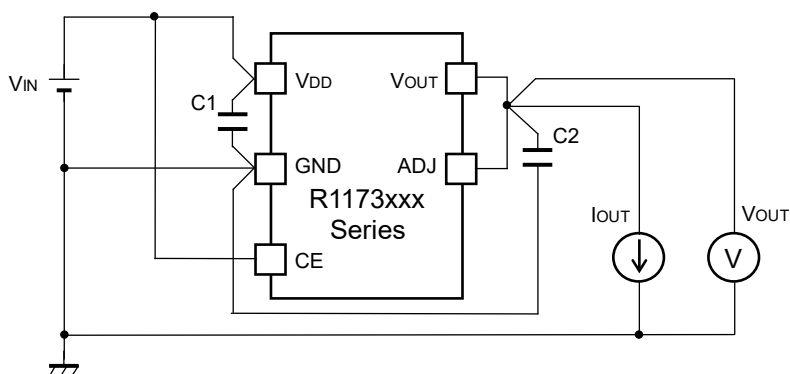

Example of the typical application of R1173x (Fixed Output Type)

### Phase Compensation

In these ICs, phase compensation is made with the output capacitor for securing stable operation even if the load current is varied. For this purpose, use as much as a capacitor as C2. Recommendation value is as follows:

### Mounting on PCB

Make  $V_{DD}$  and GND lines sufficient. If their impedance is high, a current flows, the noise picked up or unstable operation may result. Further use a  $4.7\mu\text{F}$  or more value capacitor between  $V_{DD}$  pin and GND pin as close as possible.

Set an Output capacitor between  $V_{OUT}$  pin and GND pin for phase compensation as close as possible.

Output Voltage	C2 recommendation value	Components Recommendation	
$V_{OUT} < 1.0\text{V}$	Tantalum $4.7\mu\text{F}$ or more		
$1.0 \leq V_{OUT} < 3.3\text{V}$	Ceramic $4.7\mu\text{F}$ or more	Kyocera $4.7\mu\text{F}$ (1608) Murata $4.7\mu\text{F}$ (1608) Murata $10\mu\text{F}$ (1608)	Part Number: CM105X5R475M06AB Part Number: GRM188R60J475KE19B Part Number: GRM188B30G106ME46B
$3.3\text{V} \leq V_{OUT}$	Ceramic $4.7\mu\text{F}$ or more	Kyocera $4.7\mu\text{F}$ (thin 2012) Murata $10\mu\text{F}$ (1608)	Part Number: CT21X5R475M06AB Part Number: GRM188B30G106ME46B

If you use a tantalum type capacitor and ESR value of the capacitor is large, output might be unstable. Evaluate your circuit with considering frequency characteristics.

Depending on the capacitor size, manufacturer, and part number, the bias characteristics and temperature characteristics are different. Evaluate the circuit with actual using capacitors.



## Technical Notes on Output Voltage Setting of Adjustable Output type (R1173x001x)

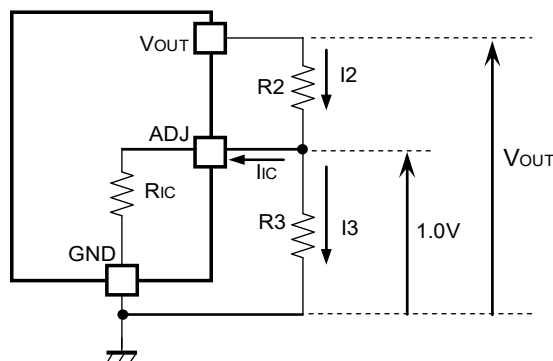

The Output Voltage may be adjustable for any output voltage between its 1.0V reference and its  $V_{DD}$  setting level. An external pair of resistors is required, as shown above.

The complete equation for the output voltage is described step by step as follows;

$$I_2 = I_{ic} + I_3 \dots\dots\dots (1)$$

$$I_3 = 1.0/R_3 \dots\dots\dots (2)$$

Thus,

$$I_2 = I_{ic} + 1.0/R_3 \dots\dots\dots (3)$$

Therefore,

$$V_{OUT} = 1.0 + R_2 \times I_2 \dots\dots\dots (4)$$

Put Equation (3) into Equation (4), then

$$\begin{aligned} V_{OUT} &= 1.0 + R_2(I_{ic} + 1.0/R_3) \\ &= 1.0(1 + R_2/R_3) + R_2 \times I_{ic} \dots\dots\dots (5) \end{aligned}$$

In 2nd term, or  $R_2 \times I_{ic}$  will produce an error in  $V_{OUT}$ .

In Equation (5),

$$I_{ic} = 1.0/R_{ic} \dots\dots\dots (6)$$

$$\begin{aligned} R_2 \times I_{ic} &= R_2 \times 1.0/R_{ic} \\ &= 1.0 \times R_2/R_{ic} \dots\dots\dots (7) \end{aligned}$$

For better accuracy, choosing  $R_2 \ll R_{ic}$  reduces this error.

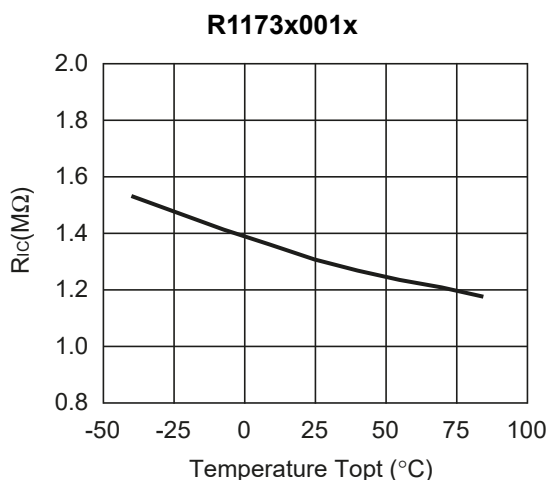

\*) The graph is a typical characteristic, please evaluate the circuit with an actual condition.

## TYPICAL CHARACTERISTICS

### 1) Output Voltage vs. Output Current (Topt=25°C)

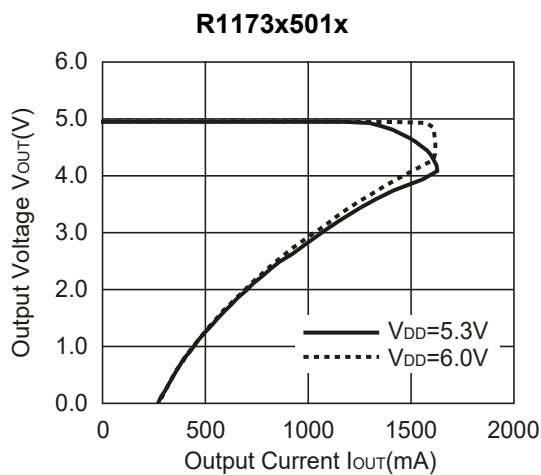
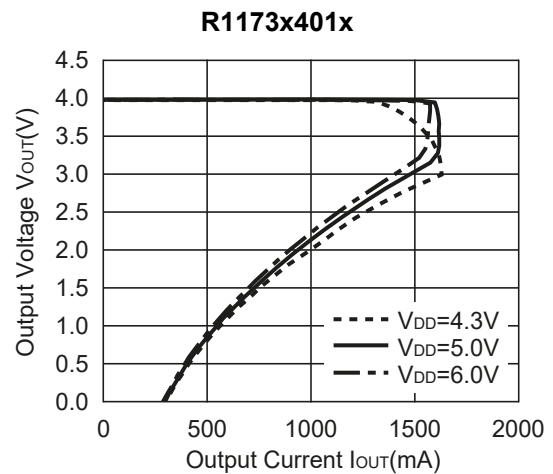
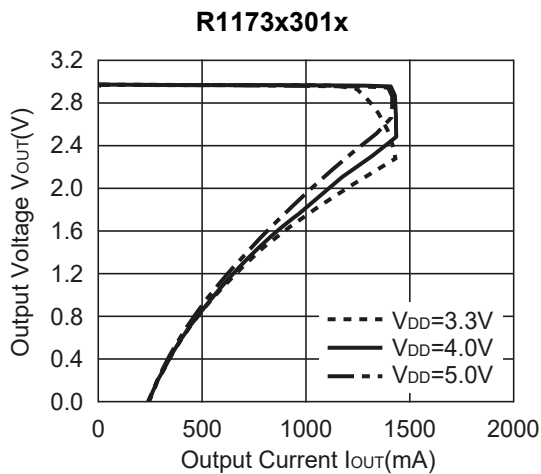
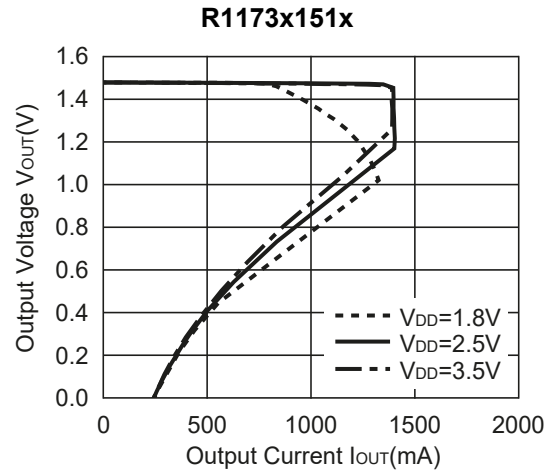
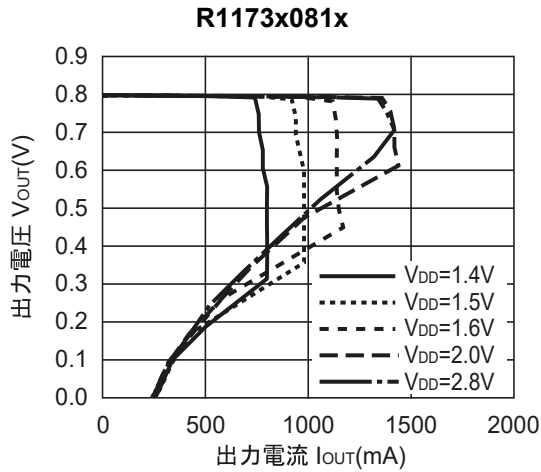

2) Output Voltage vs. Input Voltage (T<sub>opt</sub>=25°C)

R1173x081x

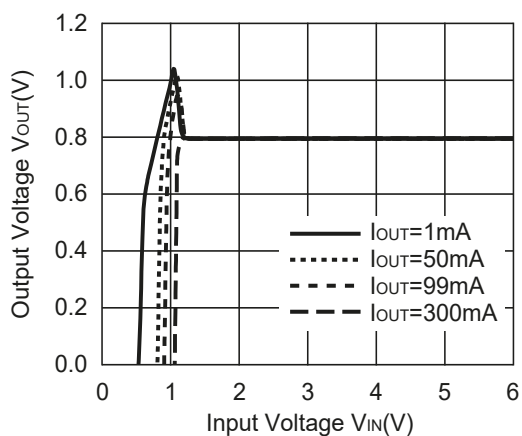

R1173x151x

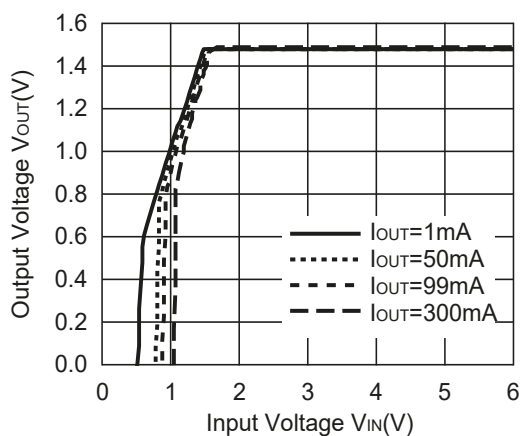

R1173x301x

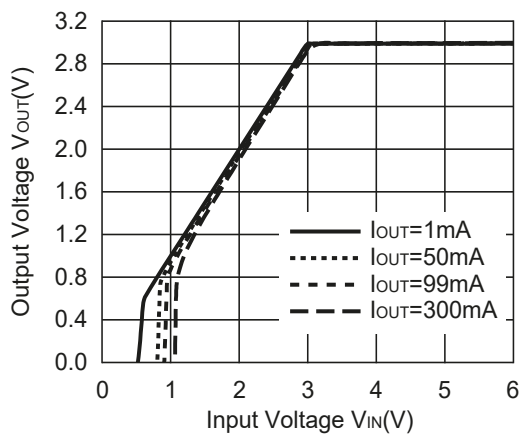

R1173x401x

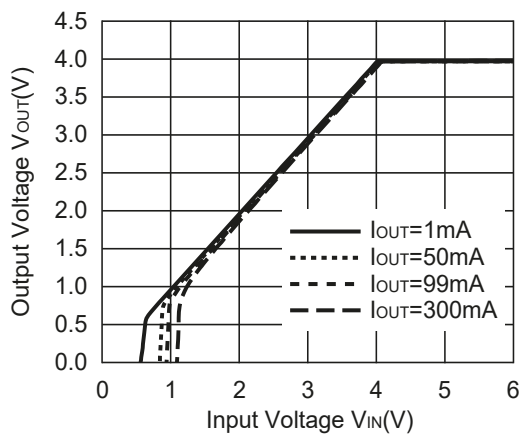

R1173x501x

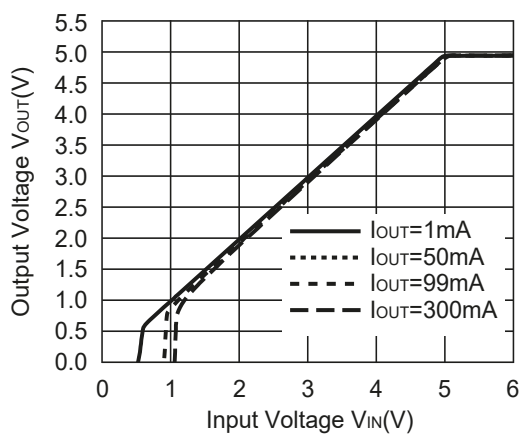

3) Dropout Voltage vs. Output Current (Topt=25°C)

R1173x081x

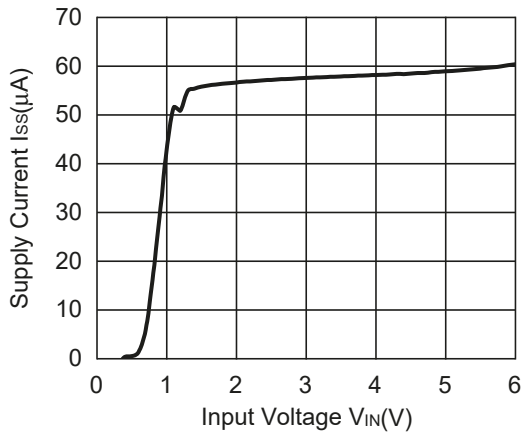

R1173x151x

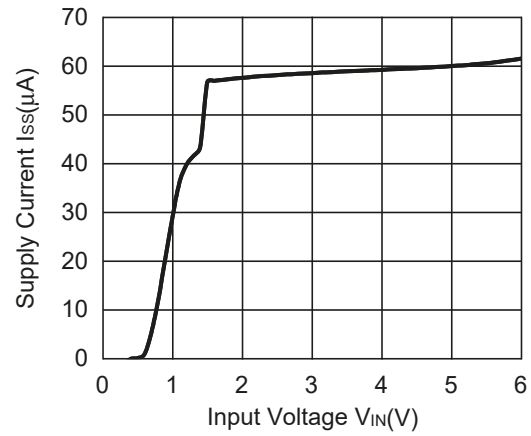

R1173x301x

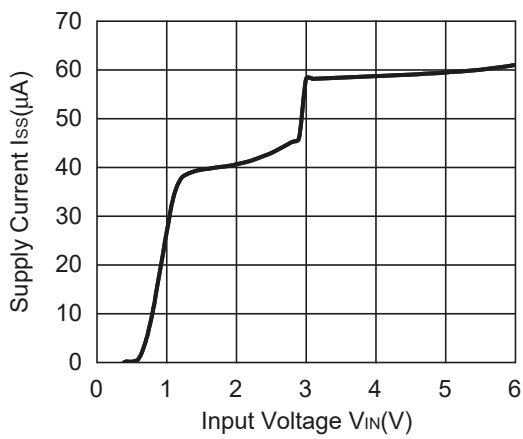

R1173x401x

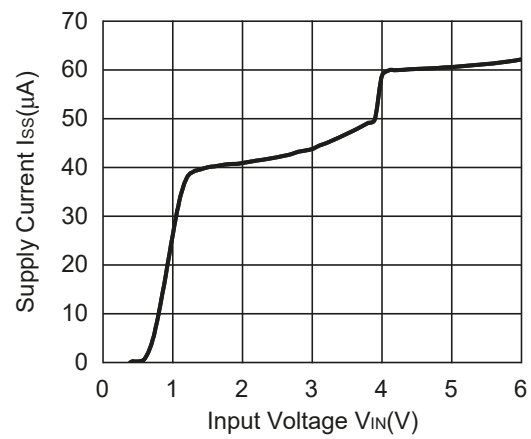

R1173x501x

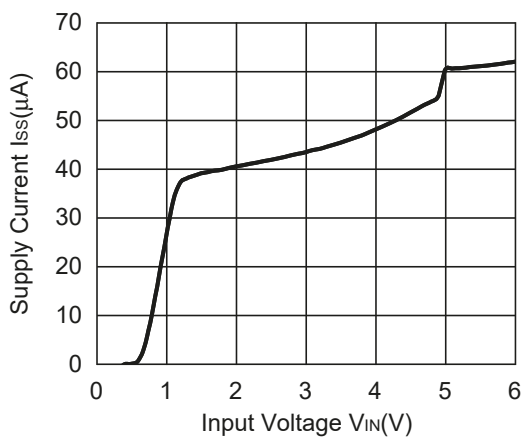

4) Output Voltage vs. Temperature ( $I_{OUT}=100mA$ )

R1173x081x

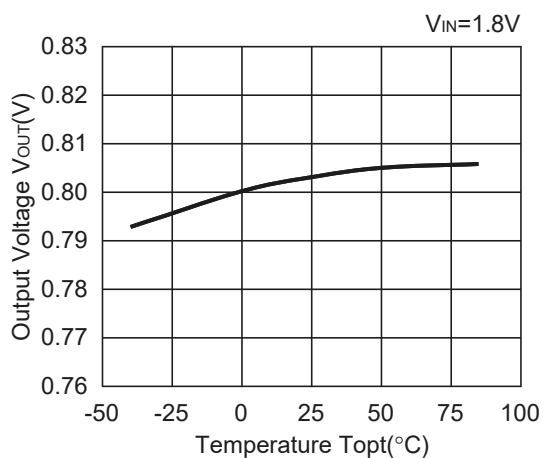

R1173x151x

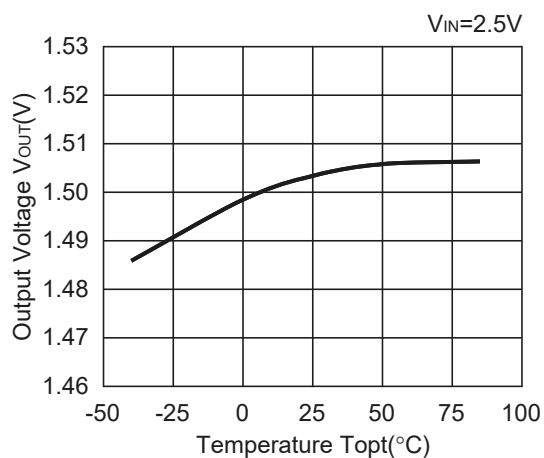

R1173x301x

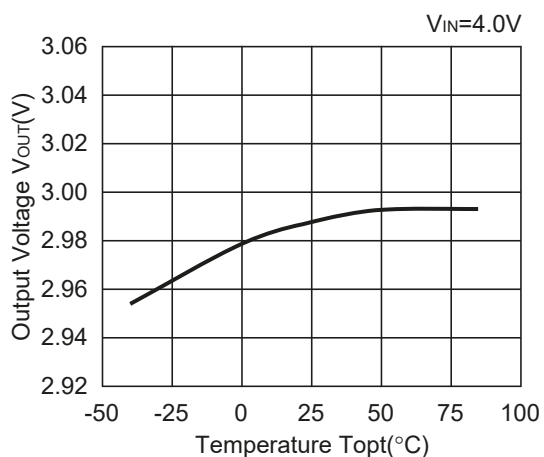

R1173x501x

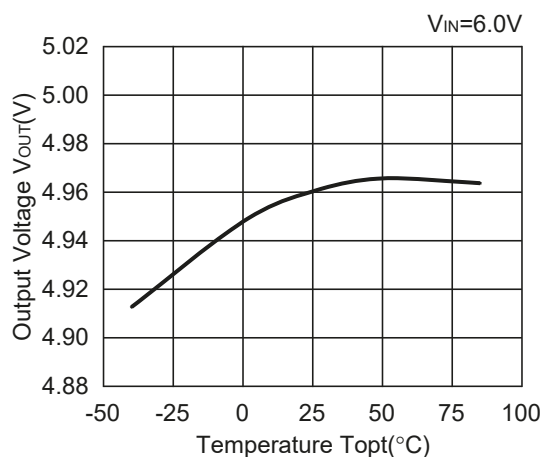

5) Supply Current vs. Temperature

R1173x081x

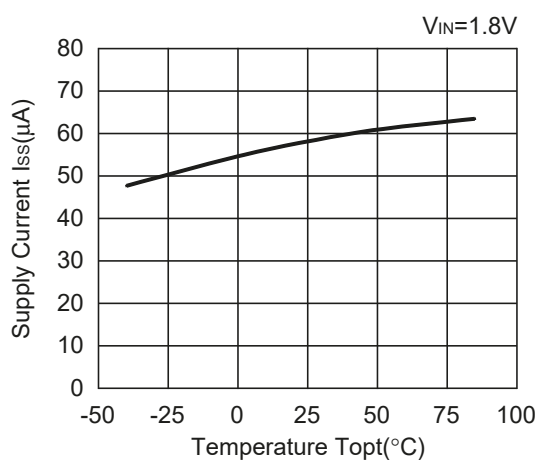

R1173x151x

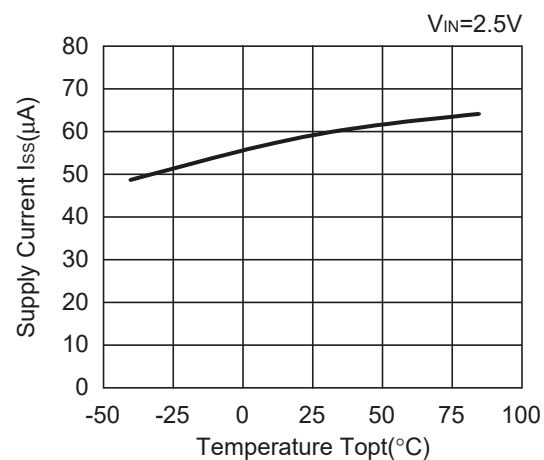

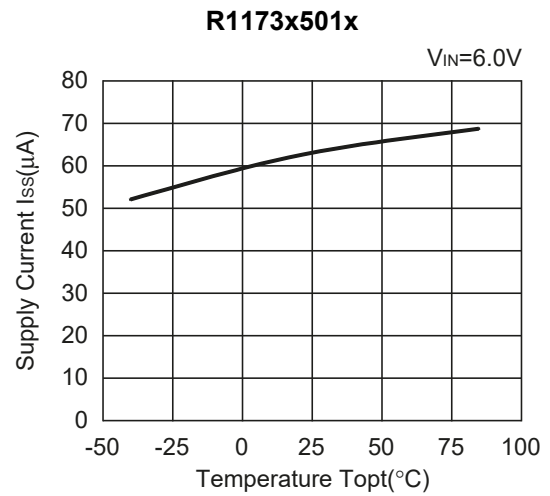
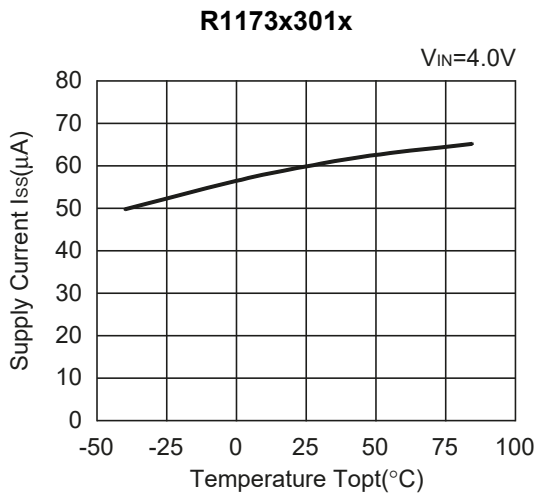

**6) Dropout Voltage vs. Output Current**

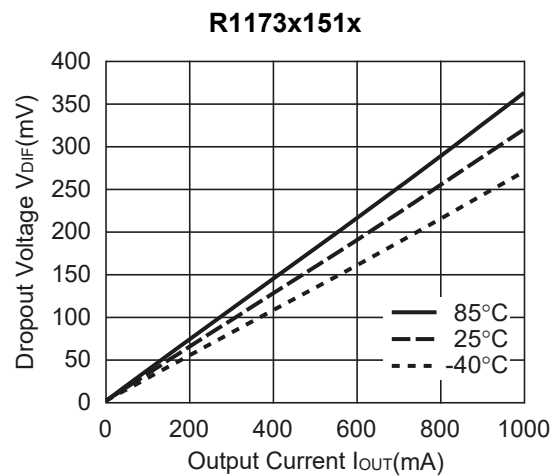
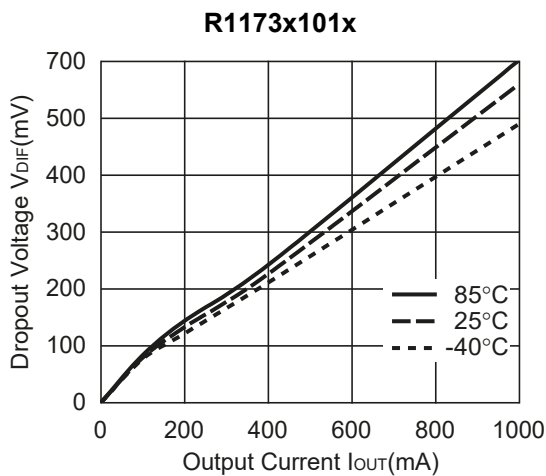
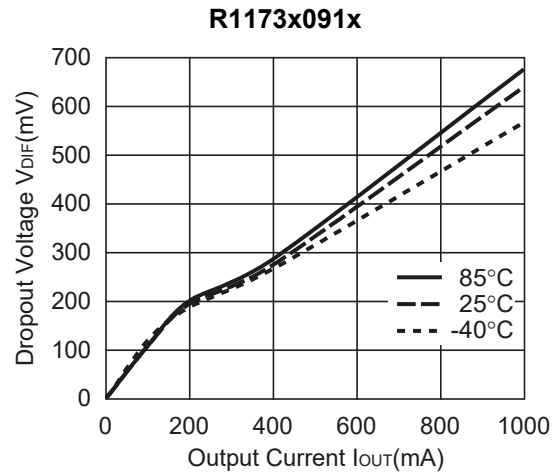
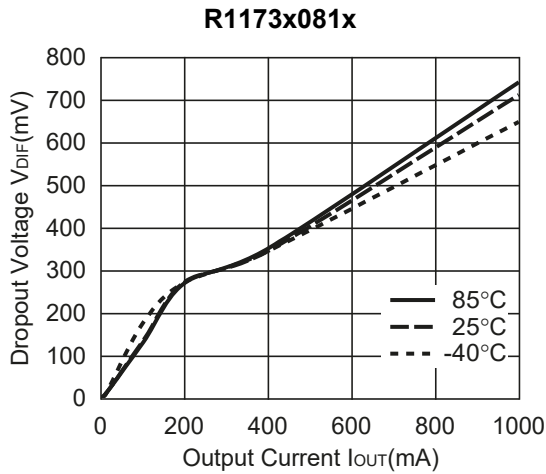

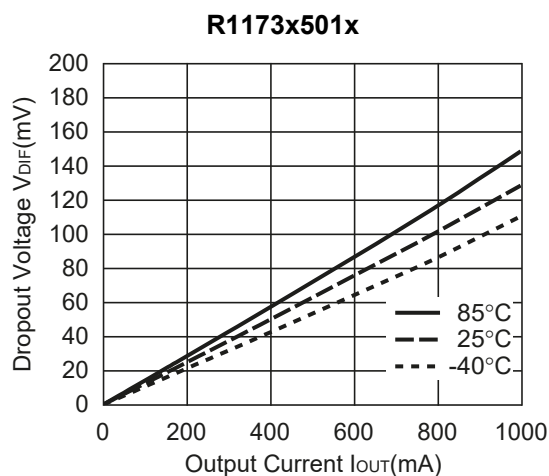
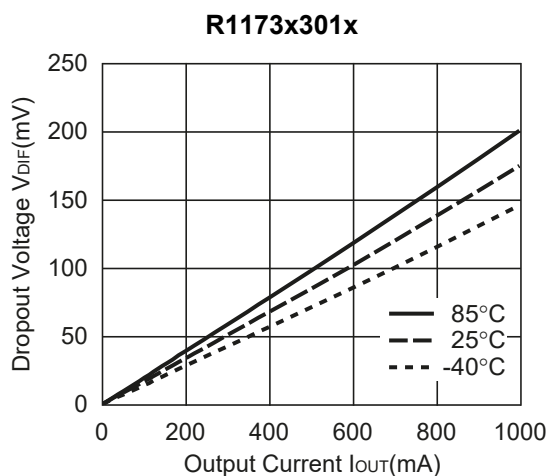

**7) Dropout Voltage vs. Set Output Voltage**

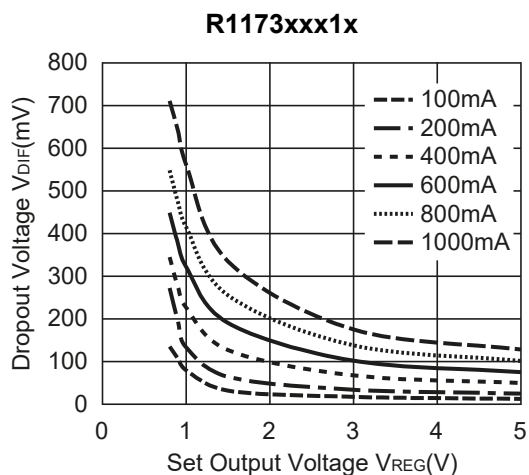

**8) 0.8V Output type, Operating Input Voltage Range**

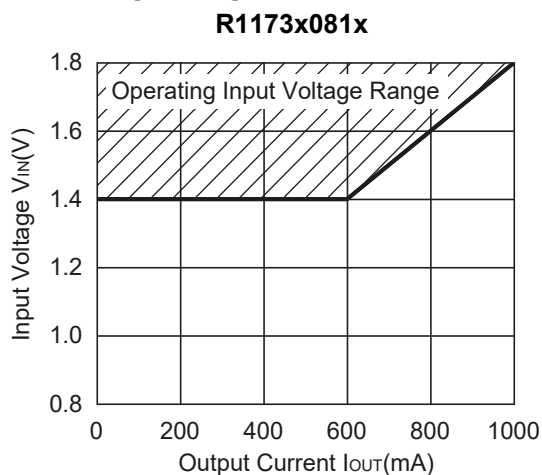

**9) Ripple Rejection vs. Input Bias**

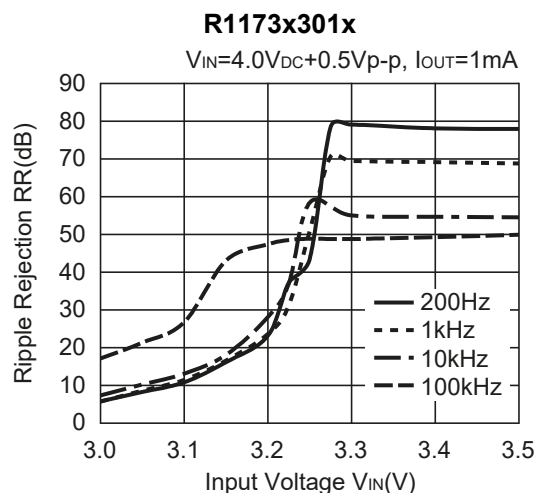
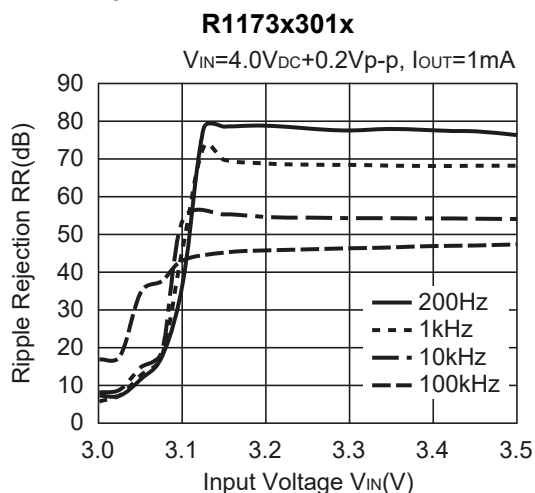

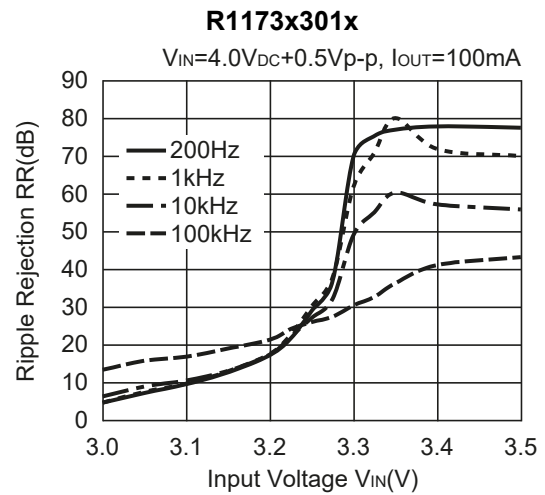
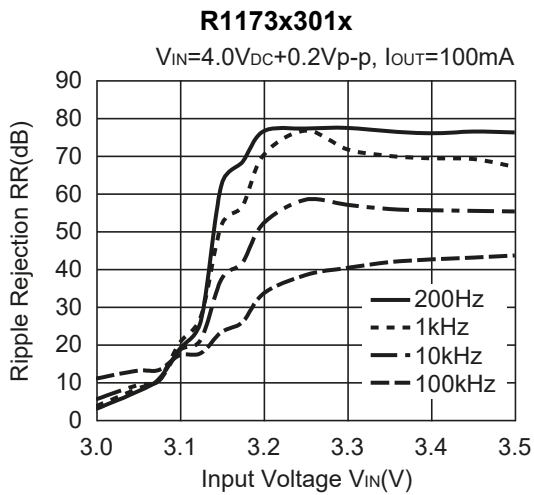
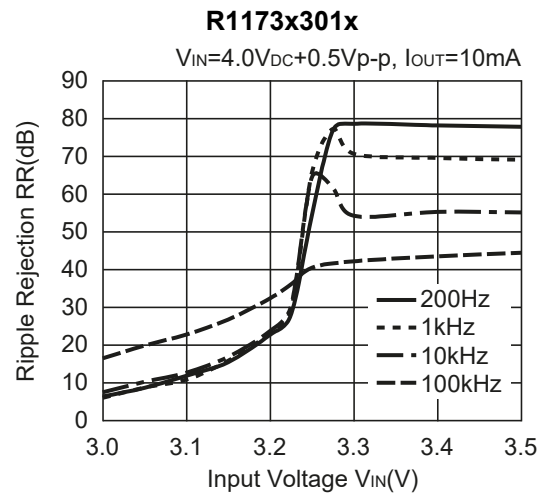
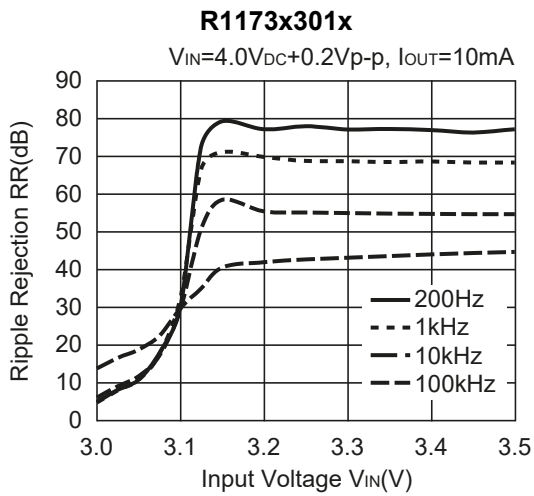

**10) Ripple Rejection vs. Frequency**

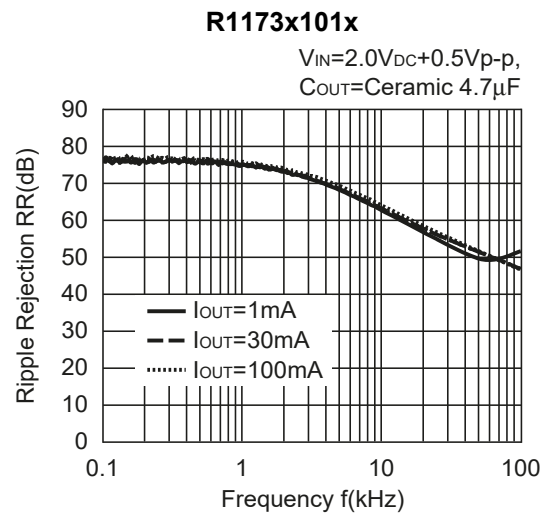
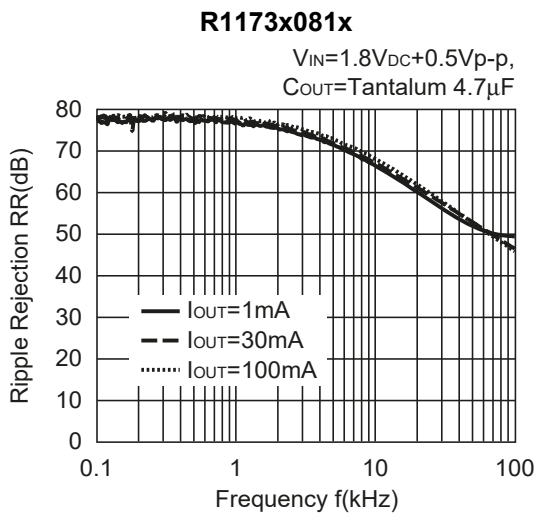



**R1173x301x**

$V_{IN}=4.0V_{DC}+0.5V_{p-p}$ ,  
 $C_{OUT}=\text{Ceramic } 4.7\mu F$

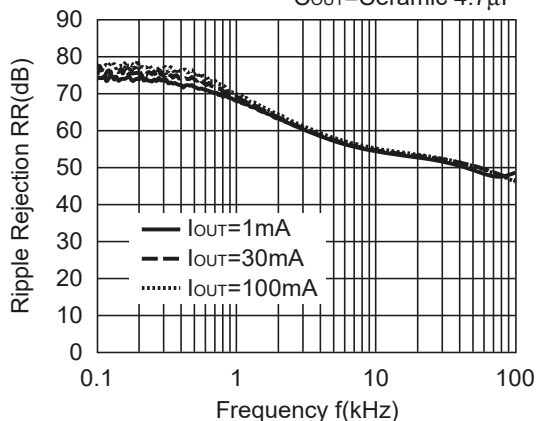

**R1173x401x**

$V_{IN}=5.0V_{DC}+0.5V_{p-p}$ ,  
 $C_{OUT}=\text{Ceramic } 4.7\mu F$

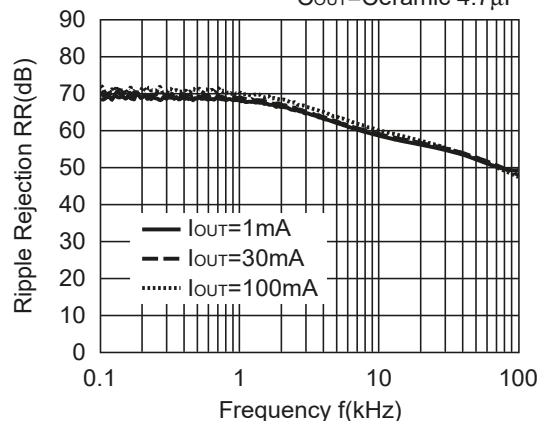

**R1173x451x**

$V_{IN}=5.5V_{DC}+0.5V_{p-p}$ ,  
 $C_{OUT}=\text{Ceramic } 4.7\mu F$

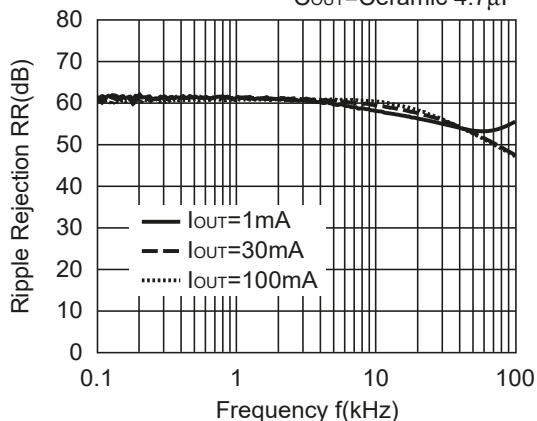

**R1173x501x**

$V_{IN}=6.0V_{DC}+0.5V_{p-p}$ ,  
 $C_{OUT}=\text{Ceramic } 4.7\mu F$

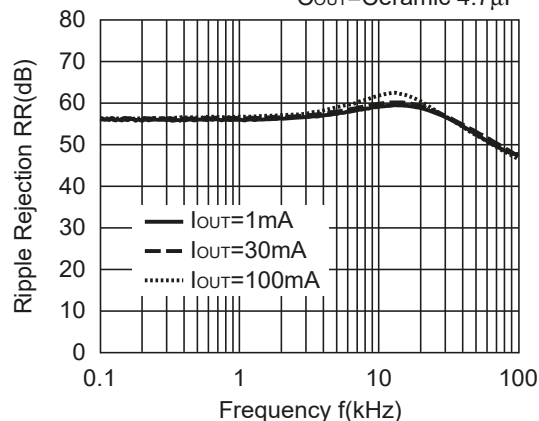

**11) Line Transient Response ( $T_r=T_f=5\mu s$ ,  $I_{OUT}=100mA$ )**

**R1173x081x**

$C_{OUT}=\text{Tantalum } 4.7\mu F$

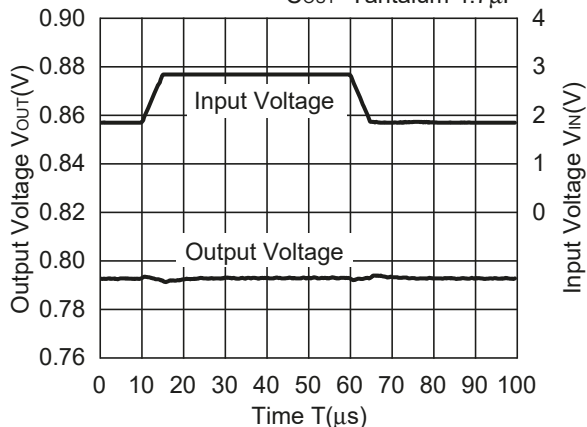

**R1173x101x**

$C_{OUT}=\text{Ceramic } 4.7\mu F$

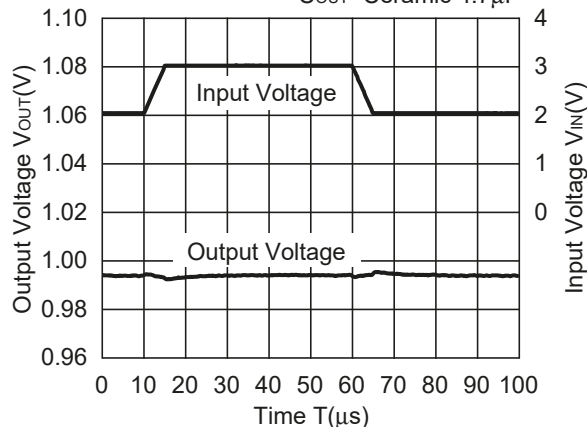

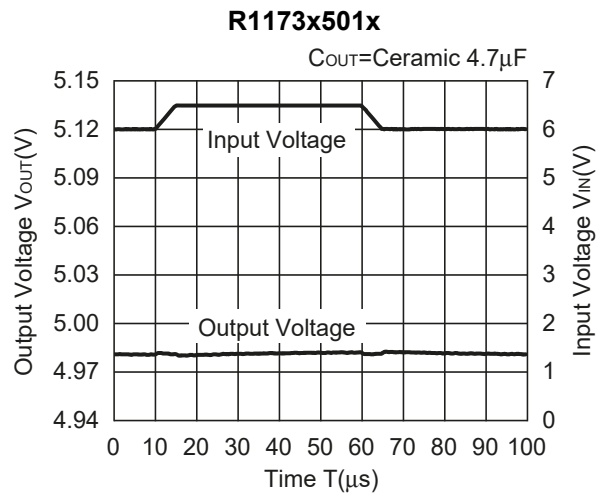
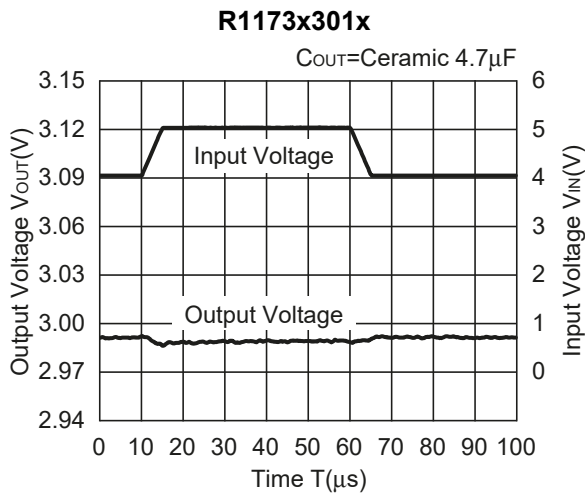

**12) Load Transient Response (Tr=Tf=500ns)**

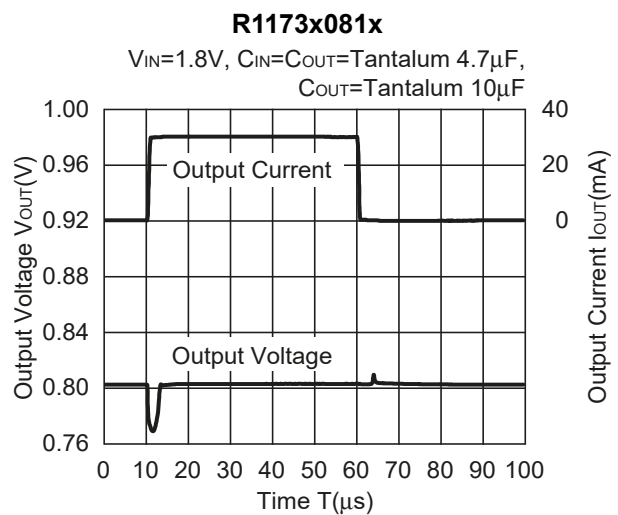
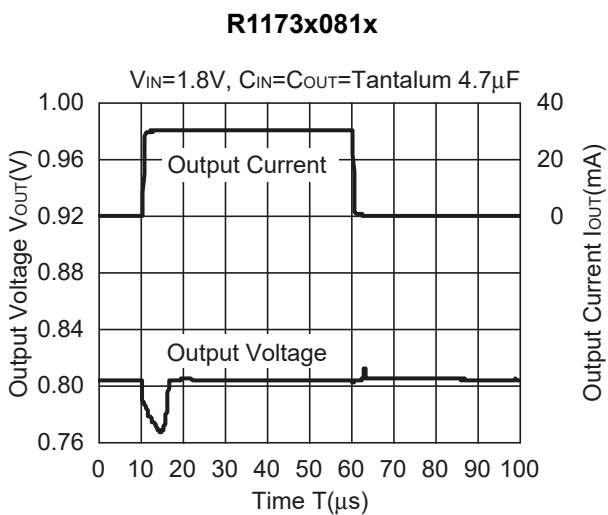
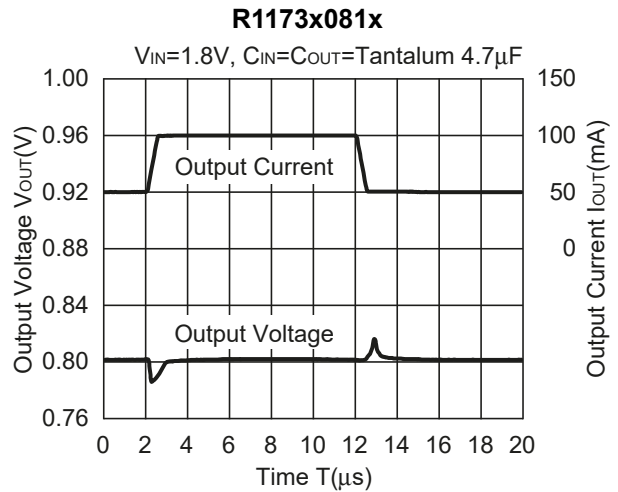
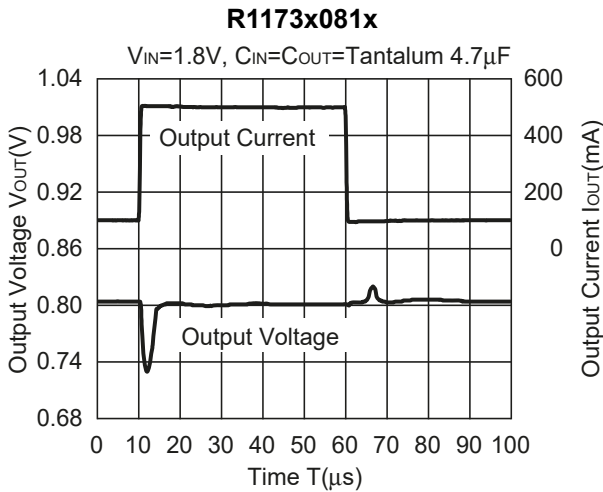

R1173x101x

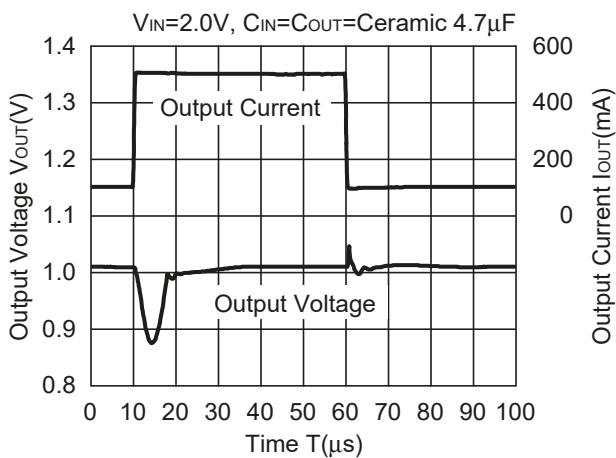

R1173x101x

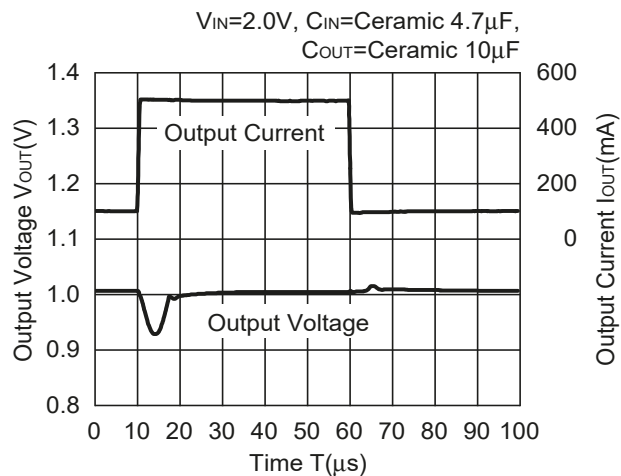

R1173x101x

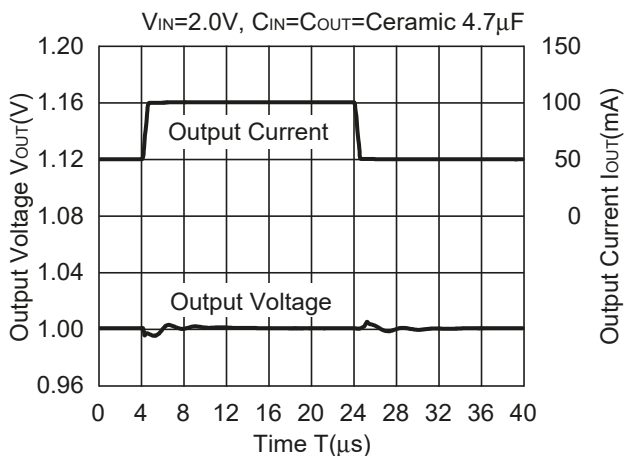

R1173x101x

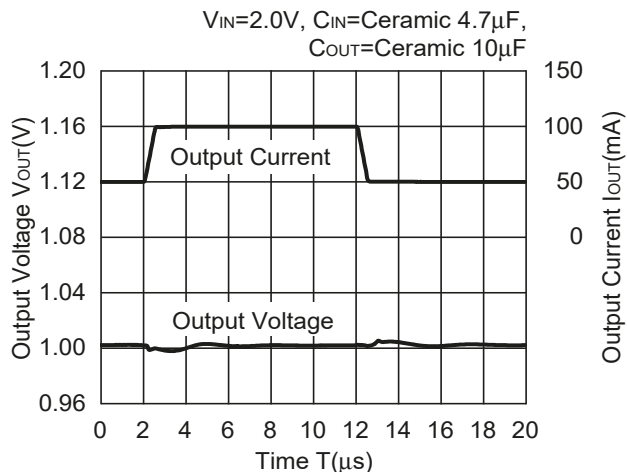

R1173x101x

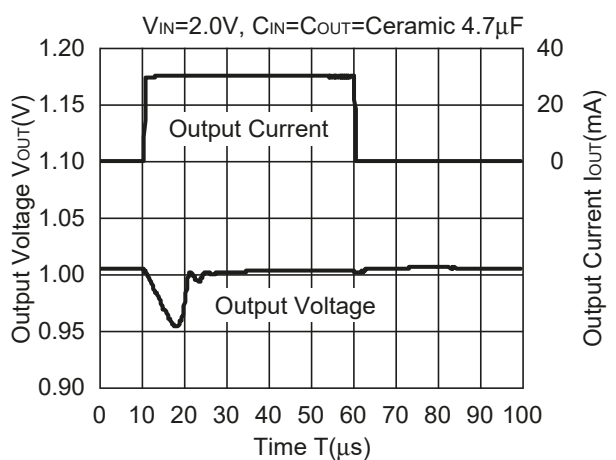

R1173x101x

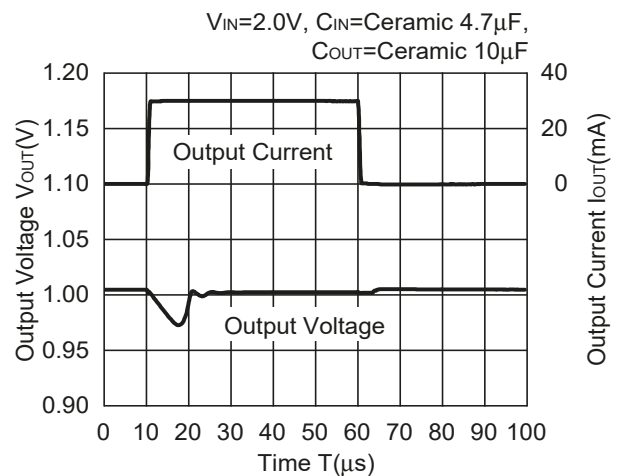

**R1173x301x**

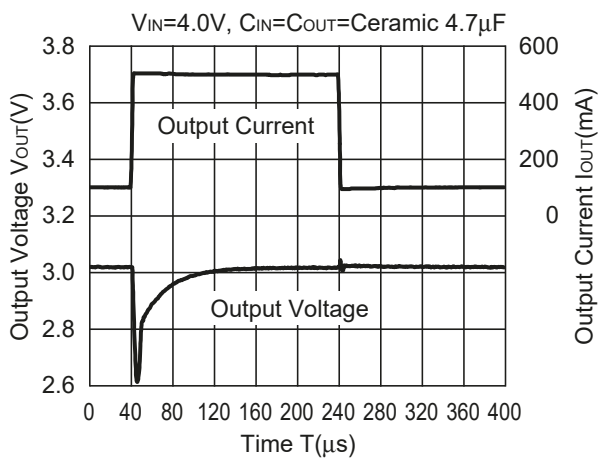

**R1173x301x**

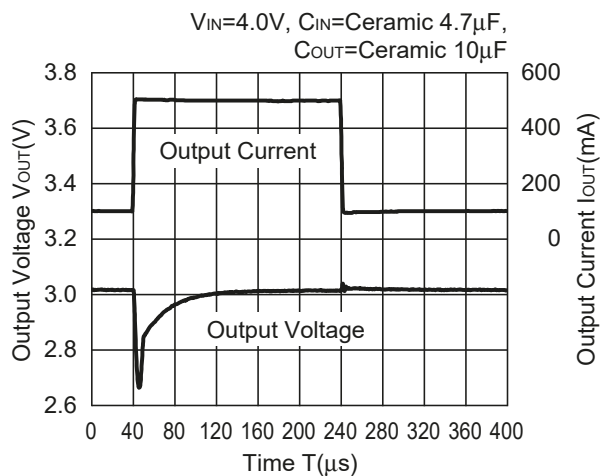

**R1173x301x**

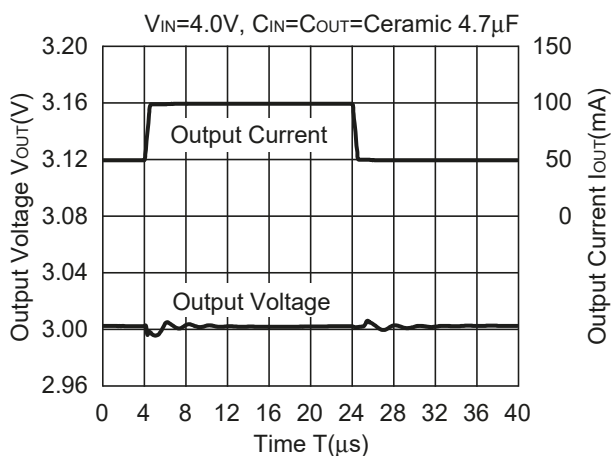

**R1173x301x**

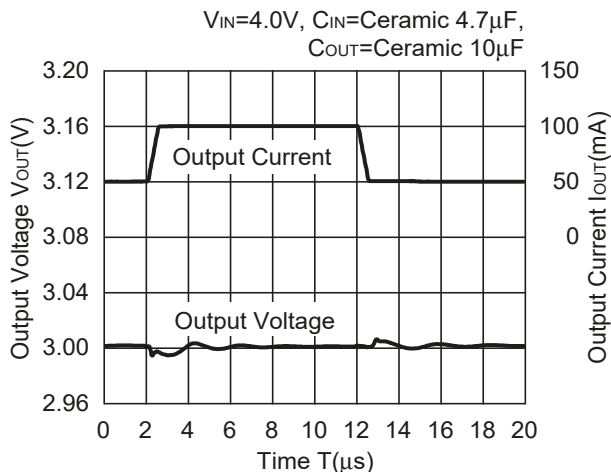

**R1173x301x**

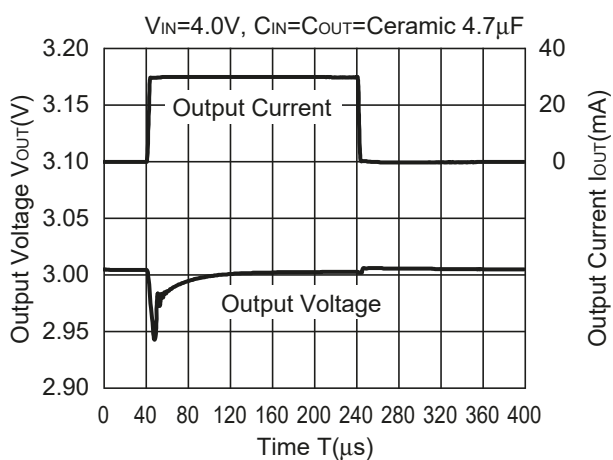

**R1173x301x**

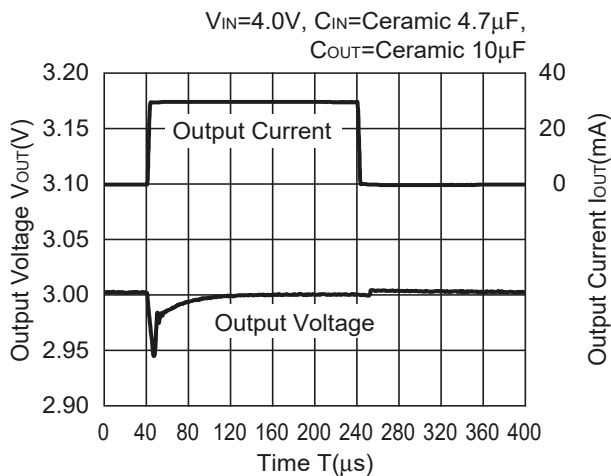

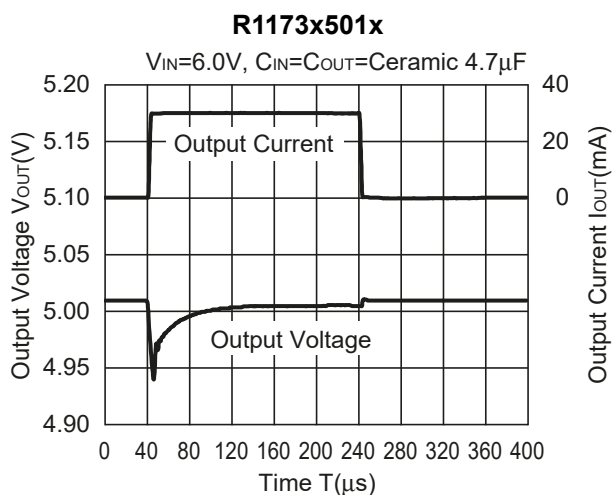
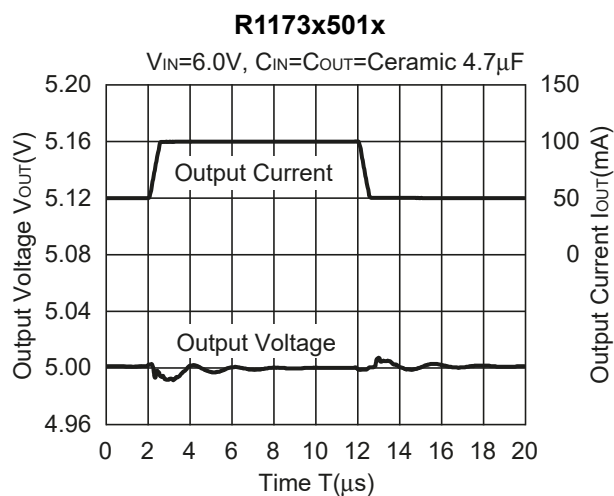
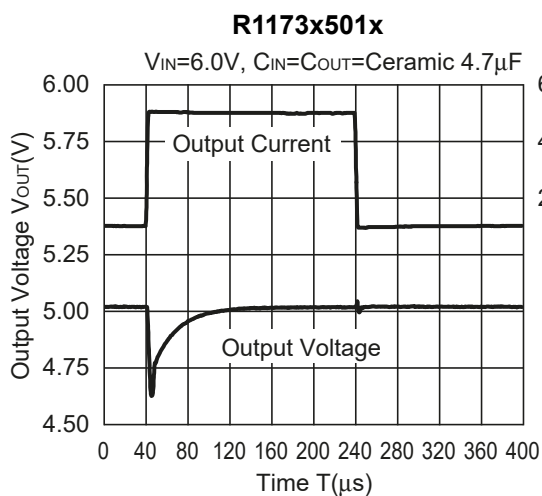

**13) Turn-on speed with CE pin control**

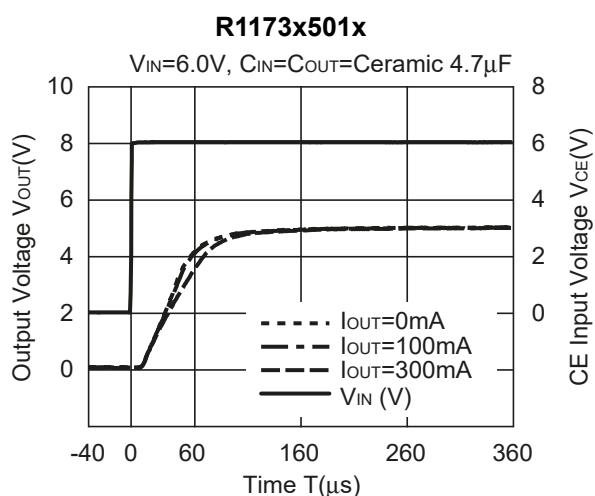
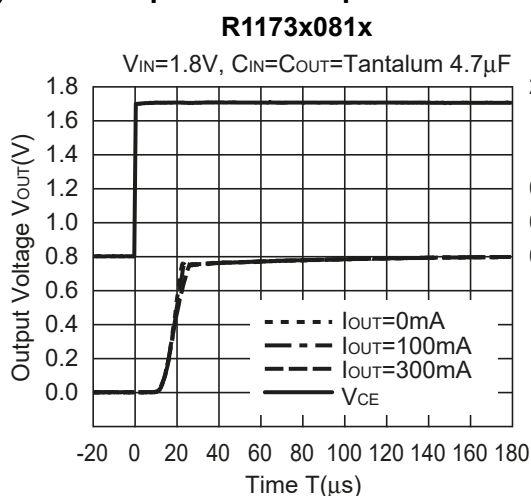

14) Turn-off speed with CE pin control

R1173x081D

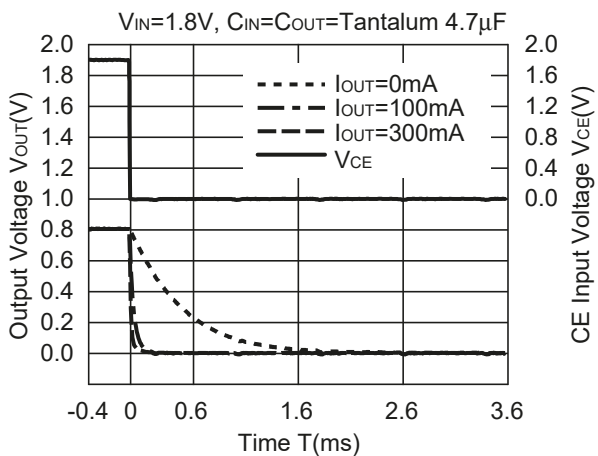

R1173x501D

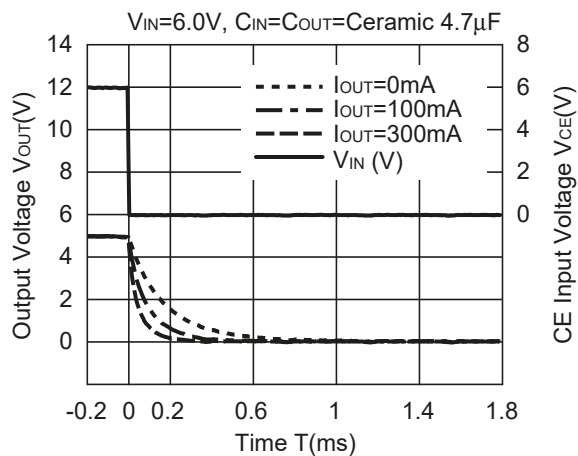

15) Inrush Current

R1173x081x

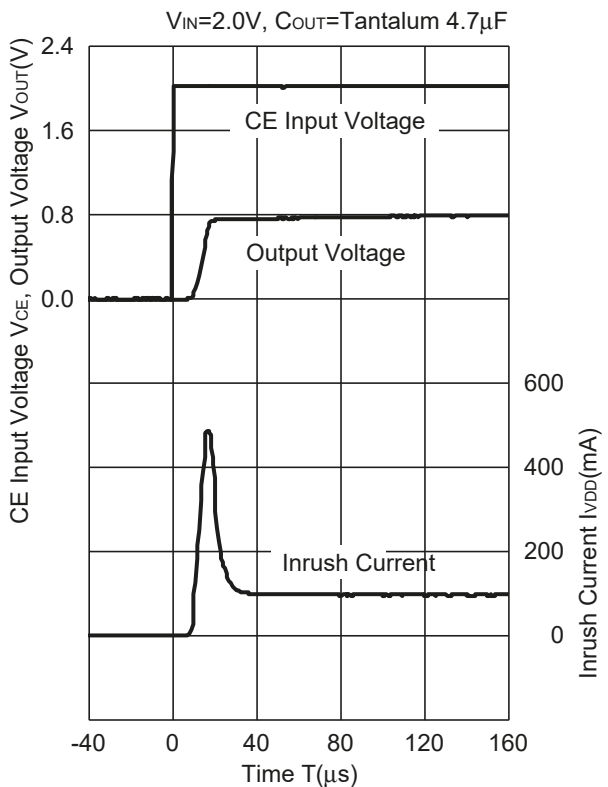

R1173x081x

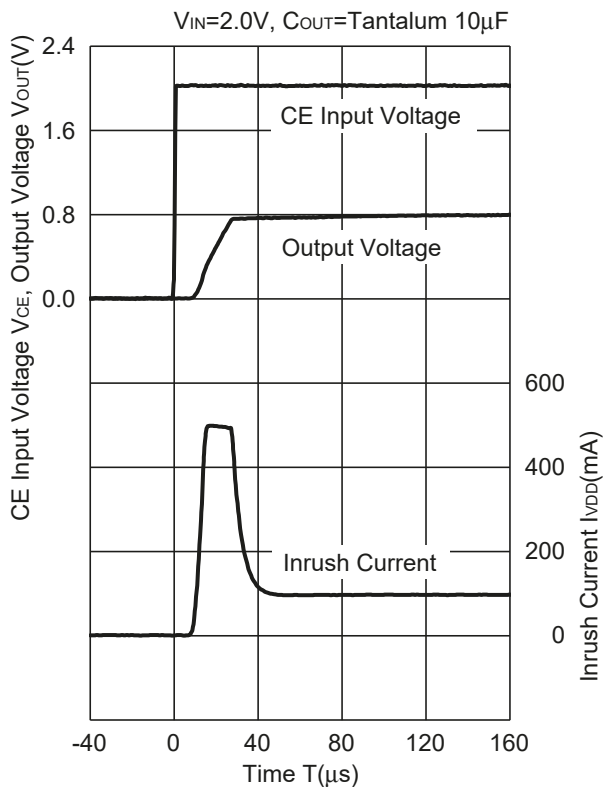

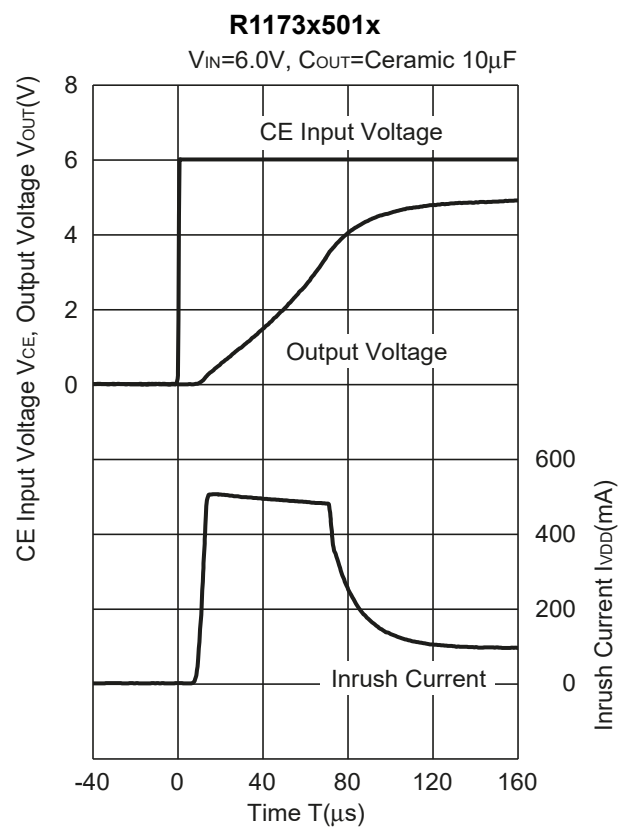
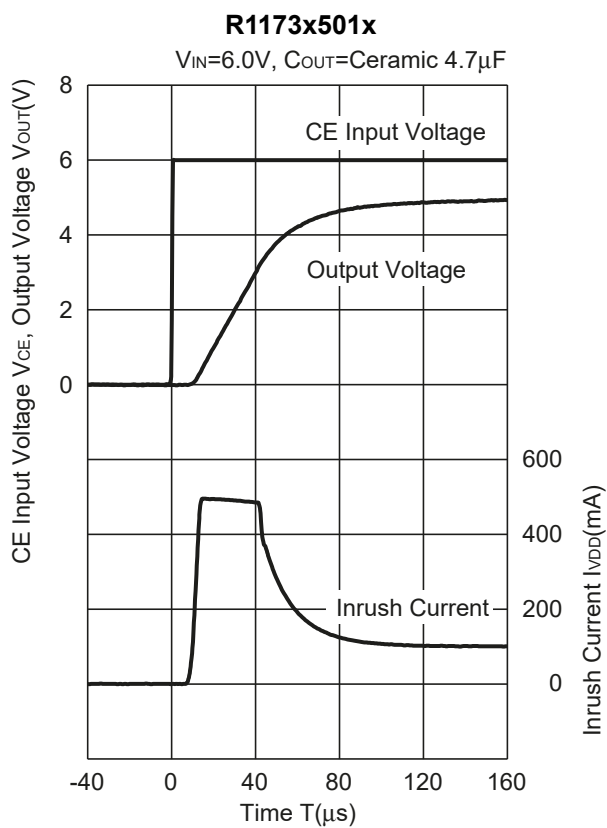
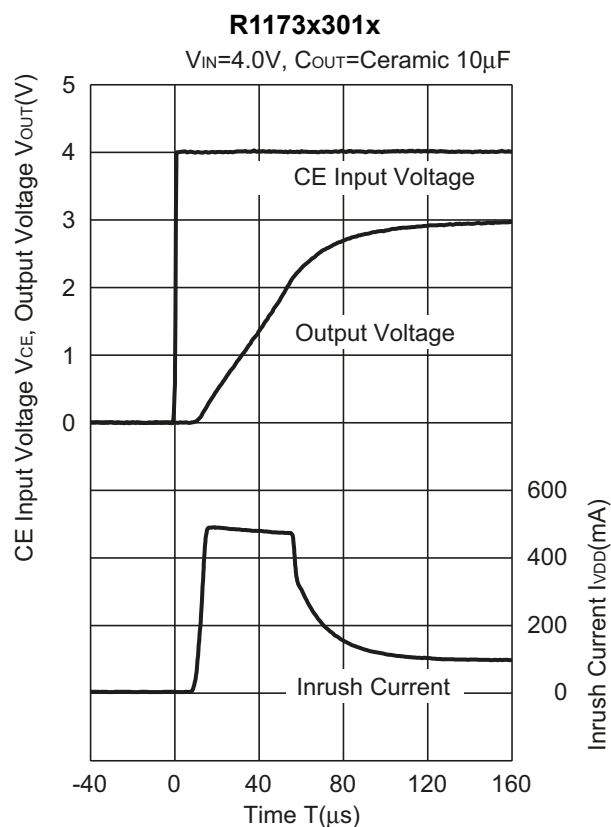
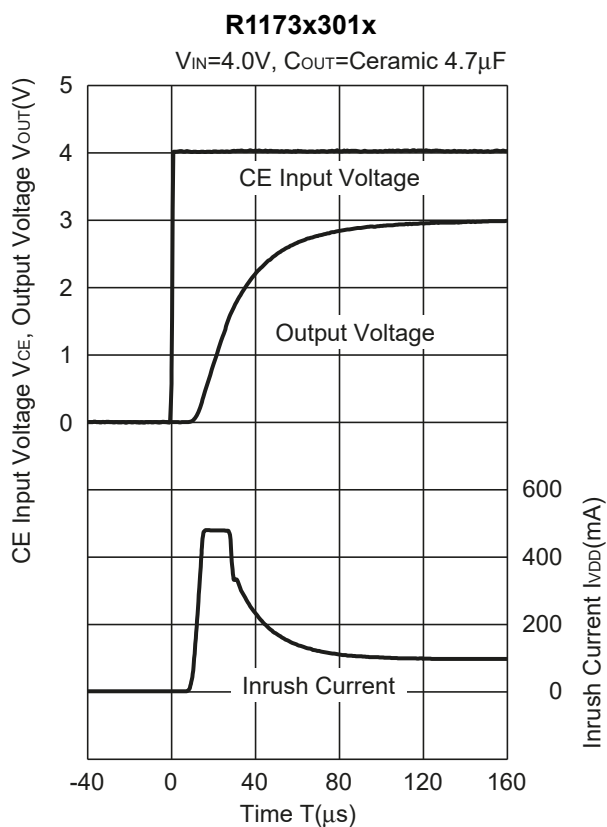

**16) Stable Area: ESR limit vs. Load current**

0.8V to 3.3V Output type :  $C_{OUT}=4.7\mu F$  (Kyocera CM105X5R475M06AB)

5.0V Output type :  $C_{OUT}=4.7\mu F$  (Kyocera CT21X5R475K06AB)

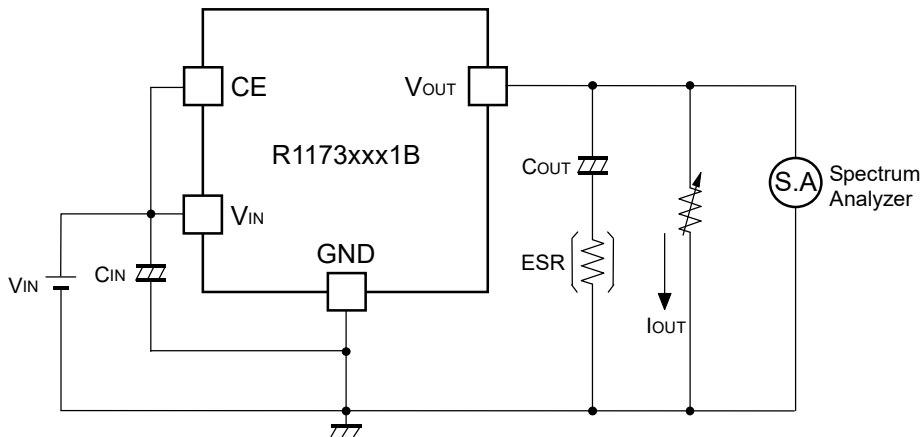

**Measurement Conditions**

- $V_{IN}=V_{OUT}+1V$
- Frequency=10Hz to 1MHz
- $T_{opt}=25^{\circ}C$

As an output capacitor for this IC, Ceramic capacitor is recommendable. However, other low ESR type capacitor can be used with this IC.

For your reference, noise level is tested, and if the noise level is  $40\mu V$  or less than  $40\mu V$ , the ESR values are plotted as stable area. Upper limit is described in the next five graphs, or ESR vs. Output Current. (Hatched area is the stable area.)

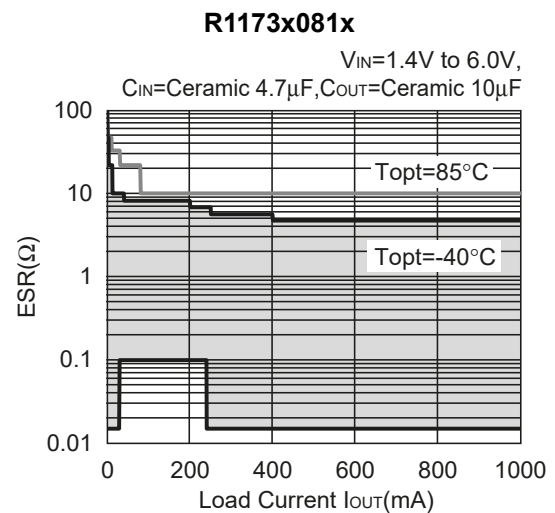
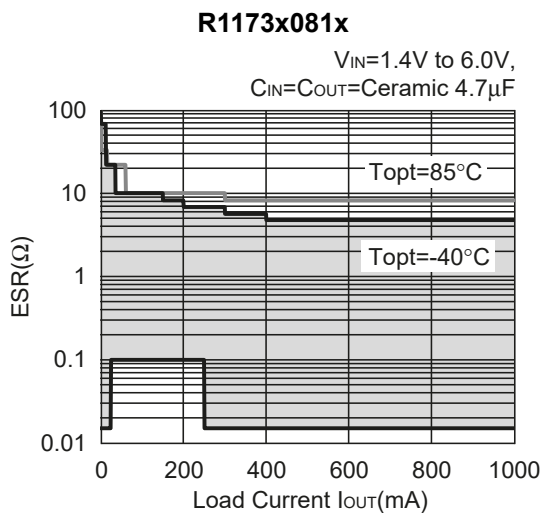



**R1173x101x**

$V_{IN}=1.4V$  to  $6.0V$ ,  
 $C_{IN}=C_{OUT}=\text{Ceramic } 4.7\mu F$

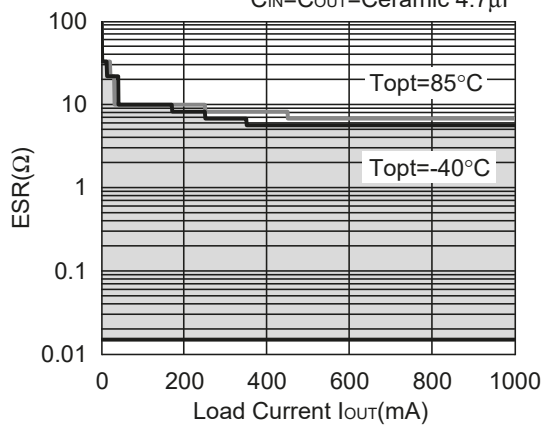

**R1173x301x**

$V_{IN}=3.1V$  to  $6.0V$ ,  
 $C_{IN}=C_{OUT}=\text{Ceramic } 4.7\mu F$

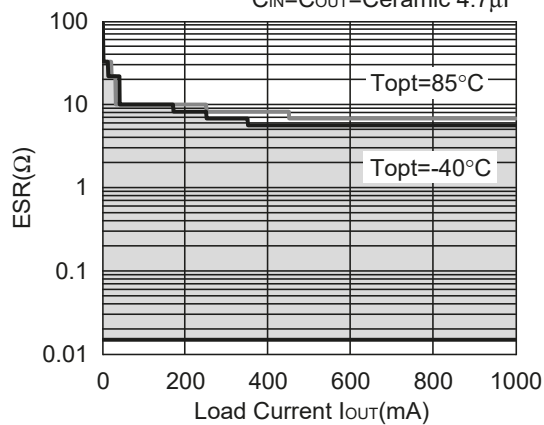

**R1173x501x**

$V_{IN}=3.1V$  to  $6.0V$ ,  
 $C_{IN}=C_{OUT}=\text{Ceramic } 4.7\mu F$

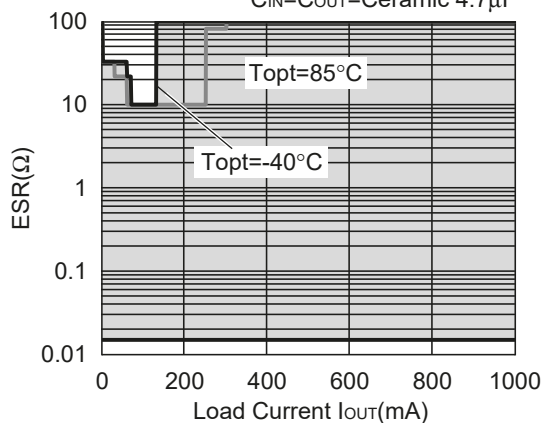

## Power Dissipation (SOT-89-5)

This specification is at mounted on board. Power Dissipation ( $P_D$ ) depends on conditions of mounting on board. This specification is based on the measurement at the condition below:

### Measurement Conditions

	High Wattage Land Pattern	Standard Land Pattern
Environment	Mounting on Board (Wind velocity=0m/s)	Mounting on Board (Wind velocity=0m/s)
Board Material	Glass cloth epoxy plastic (Double sided)	Glass cloth epoxy plastic (Double sided)
Board Dimensions	30mm x 30mm x 1.6mm	50mm x 50mm x 1.6mm
Copper Ratio	Top side : Approx. 20% , Back side : Approx. 100%	Top side : Approx. 10% , Back side : Approx. 100%
Through-hole	$\phi 0.85\text{mm} \times 10\text{pcs}$	-

### Measurement Result

( $T_a=25^\circ\text{C}, T_{j\text{max}}=125^\circ\text{C}$ )

	High Wattage Land Pattern	Standard Land Pattern	Free Air
Power Dissipation	1300mW	900mW	500mW
Thermal Resistance	$77^\circ\text{C/W}$	$111^\circ\text{C/W}$	$200^\circ\text{C/W}$

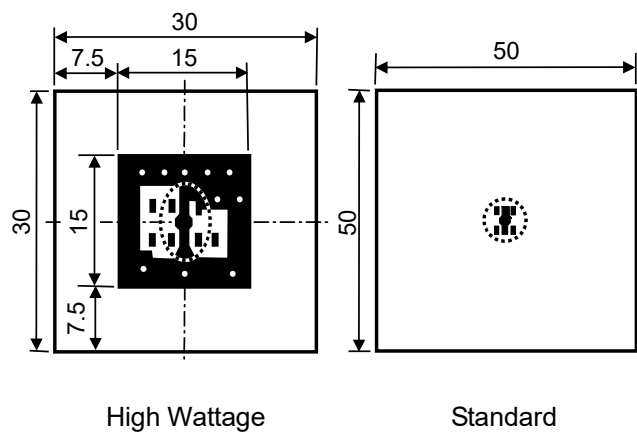
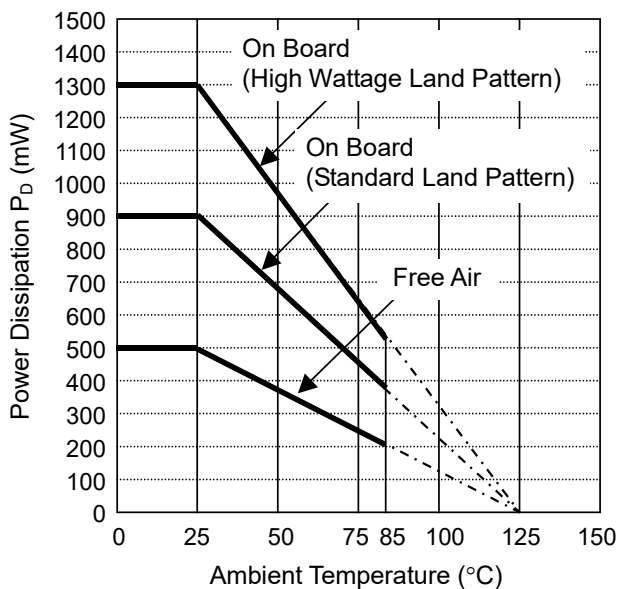

Measurement Board Pattern

IC Mount Area Unit : mm

Power Dissipation

**Package Dimensions (SOT-89-5)**

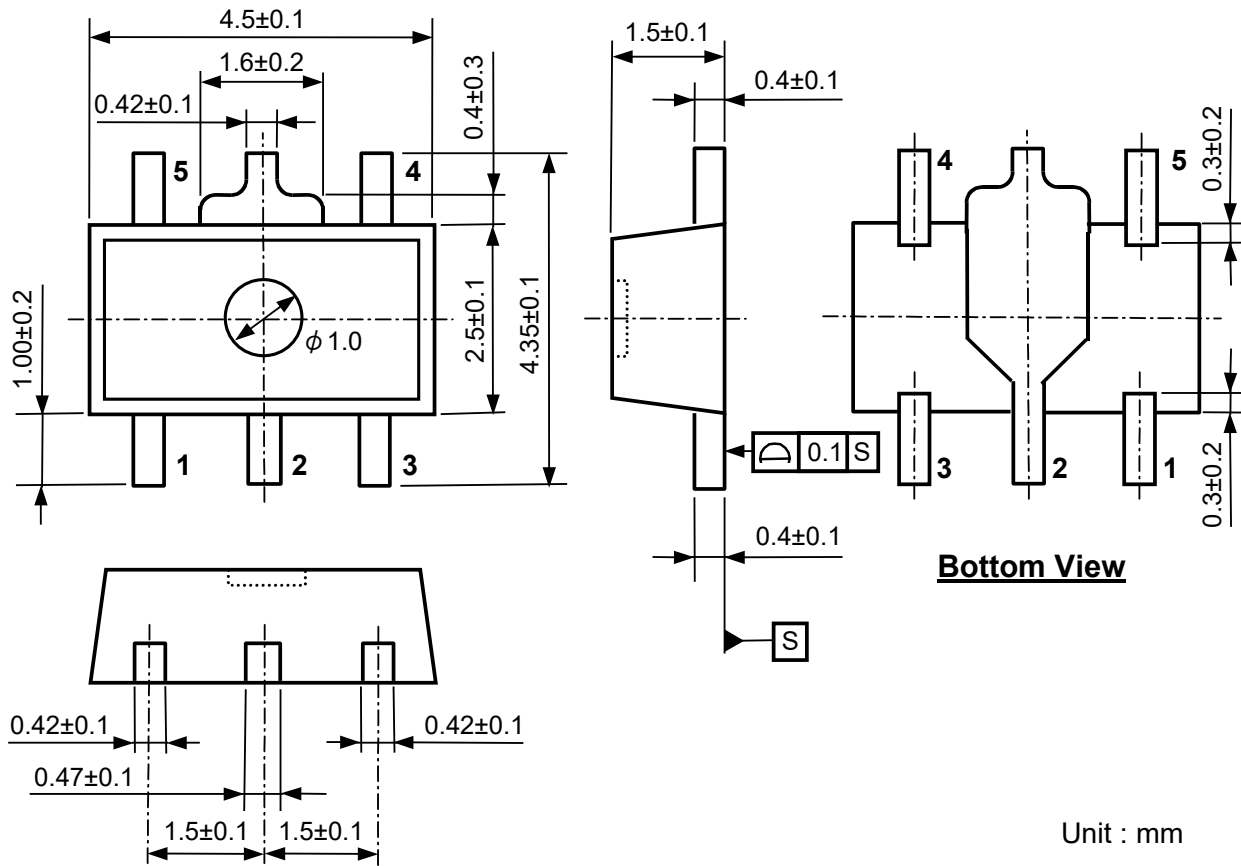

## Mark Specification (SOT-89-5)

①②③④ : Product Code ....Refer to the marking list table

⑤⑥ : Lot No.....Alphanumeric serial number.

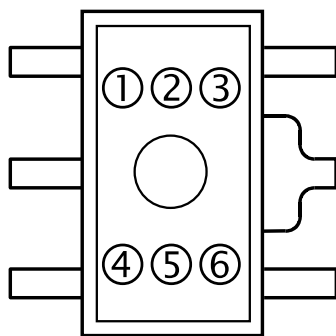

R1173H Series Marking List Table

PKG : SOT-89-5

<b>R1173Hxx1B</b>		<b>R1173Hxx1D</b>	
Part Number	①②③④	Part Number	①②③④
R1173H081B	<b>L08B</b>	R1173H081D	<b>L08D</b>
R1173H091B	<b>L09B</b>	R1173H091D	<b>L09D</b>
R1173H101B	<b>L10B</b>	R1173H101D	<b>L10D</b>
R1173H111B	<b>L11B</b>	R1173H111D	<b>L11D</b>
R1173H121B	<b>L12B</b>	R1173H121D	<b>L12D</b>
R1173H131B	<b>L13B</b>	R1173H131D	<b>L13D</b>
R1173H141B	<b>L14B</b>	R1173H141D	<b>L14D</b>
R1173H151B	<b>L15B</b>	R1173H151D	<b>L15D</b>
R1173H161B	<b>L16B</b>	R1173H161D	<b>L16D</b>
R1173H171B	<b>L17B</b>	R1173H171D	<b>L17D</b>
R1173H181B	<b>L18B</b>	R1173H181D	<b>L18D</b>
R1173H191B	<b>L19B</b>	R1173H191D	<b>L19D</b>
R1173H201B	<b>L20B</b>	R1173H201D	<b>L20D</b>
R1173H211B	<b>L21B</b>	R1173H211D	<b>L21D</b>
R1173H221B	<b>L22B</b>	R1173H221D	<b>L22D</b>
R1173H231B	<b>L23B</b>	R1173H231D	<b>L23D</b>
R1173H241B	<b>L24B</b>	R1173H241D	<b>L24D</b>
R1173H251B	<b>L25B</b>	R1173H251D	<b>L25D</b>
R1173H261B	<b>L26B</b>	R1173H261D	<b>L26D</b>
R1173H271B	<b>L27B</b>	R1173H271D	<b>L27D</b>
R1173H281B	<b>L28B</b>	R1173H281D	<b>L28D</b>
R1173H291B	<b>L29B</b>	R1173H291D	<b>L29D</b>
R1173H301B	<b>L30B</b>	R1173H301D	<b>L30D</b>
R1173H311B	<b>L31B</b>	R1173H311D	<b>L31D</b>
R1173H321B	<b>L32B</b>	R1173H321D	<b>L32D</b>
R1173H331B	<b>L33B</b>	R1173H331D	<b>L33D</b>
R1173H341B	<b>L34B</b>	R1173H341D	<b>L34D</b>
R1173H351B	<b>L35B</b>	R1173H351D	<b>L35D</b>
R1173H361B	<b>L36B</b>	R1173H361D	<b>L36D</b>
R1173H371B	<b>L37B</b>	R1173H371D	<b>L37D</b>
R1173H381B	<b>L38B</b>	R1173H381D	<b>L38D</b>
R1173H391B	<b>L39B</b>	R1173H391D	<b>L39D</b>
R1173H401B	<b>L40B</b>	R1173H401D	<b>L40D</b>
R1173H411B	<b>L41B</b>	R1173H411D	<b>L41D</b>
R1173H421B	<b>L42B</b>	R1173H421D	<b>L42D</b>
R1173H431B	<b>L43B</b>	R1173H431D	<b>L43D</b>
R1173H441B	<b>L44B</b>	R1173H441D	<b>L44D</b>
R1173H451B	<b>L45B</b>	R1173H451D	<b>L45D</b>
R1173H461B	<b>L46B</b>	R1173H461D	<b>L46D</b>
R1173H471B	<b>L47B</b>	R1173H471D	<b>L47D</b>
R1173H481B	<b>L48B</b>	R1173H481D	<b>L48D</b>
R1173H491B	<b>L49B</b>	R1173H491D	<b>L49D</b>
R1173H501B	<b>L50B</b>	R1173H501D	<b>L50D</b>
R1173H181B5	<b>L01B</b>	R1173H181D5	<b>L01D</b>
R1173H281B5	<b>L02B</b>	R1173H281D5	<b>L02D</b>
R1173H12B5	<b>L03B</b>	R1173H121D5	<b>L03D</b>
R1173H001B	<b>L00B</b>	R1173H001D	<b>L00D</b>

## Power Dissipation (HSON-6)

This specification is at mounted on board. Power Dissipation ( $P_D$ ) depends on conditions of mounting on board. This specification is based on the measurement at the condition below:

### Measurement Conditions

	Standard Land Pattern
Environment	Mounting on Board (Wind velocity=0m/s)
Board Material	Glass cloth epoxy plastic (Double sided)
Board Dimensions	40mm x 40mm x 1.6mm
Copper Ratio	Top side: Approx. 50%, Back side: Approx. 50%
Through-hole	$\phi$ 0.5mm x 44pcs

### Measurement Result

( $T_a=25^\circ\text{C}$ ,  $T_{j\text{max}}=125^\circ\text{C}$ )

	Standard Land Pattern	Free Air
Power Dissipation	900mW	400mW
Thermal Resistance	$\theta_{ja} = (125-25^\circ\text{C}) / 0.9\text{W} = 111^\circ\text{C/W}$	$250^\circ\text{C/W}$

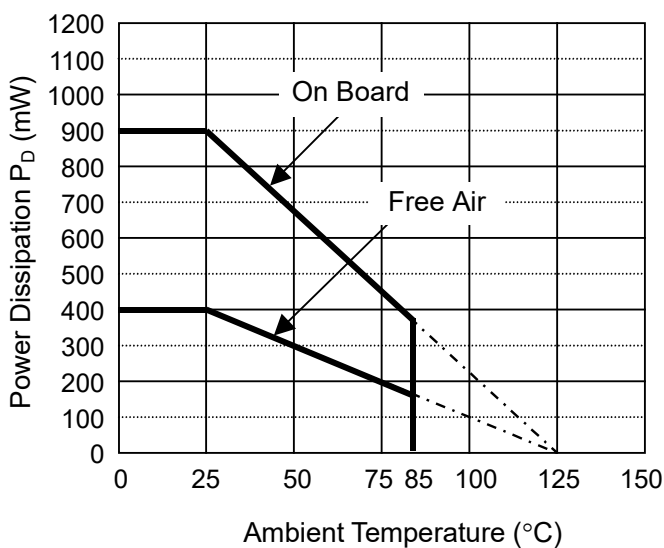

Power Dissipation

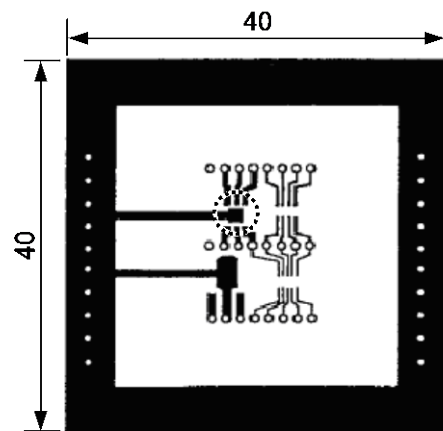

Measurement Board Pattern

 IC Mount Area Unit : mm

### Package Dimensions (HSO6-6)

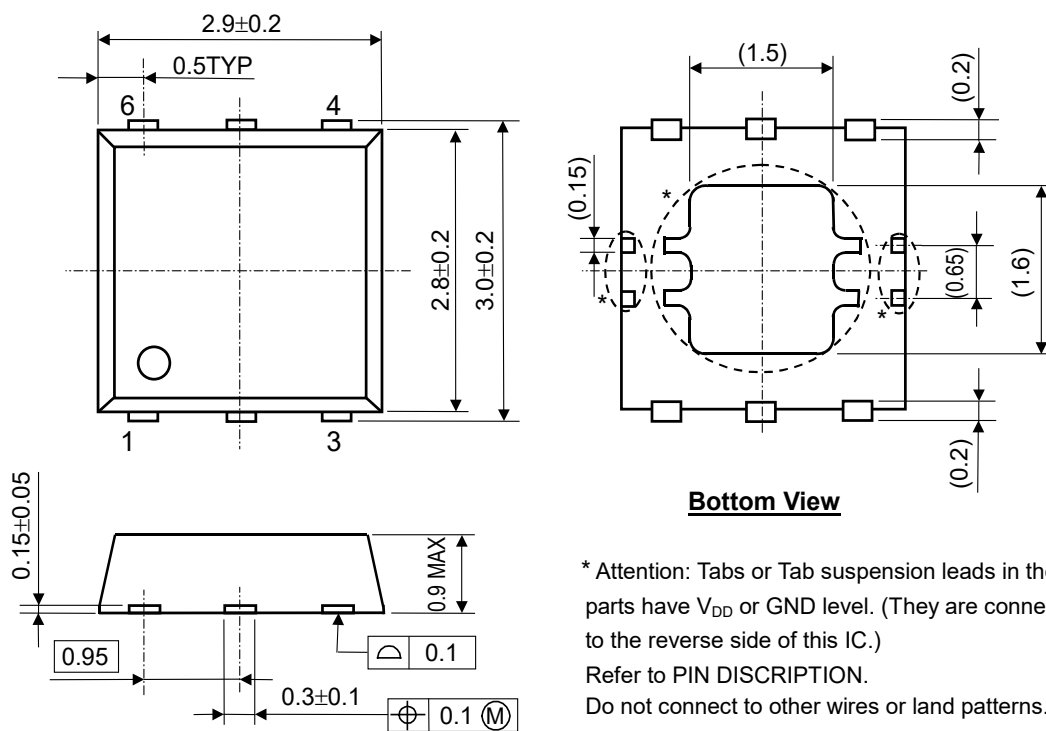

**Bottom View**

\* Attention: Tabs or Tab suspension leads in the  parts have  $V_{DD}$  or GND level. (They are connected to the reverse side of this IC.)  
 Refer to PIN DISCRIPTION.  
 Do not connect to other wires or land patterns.

Unit: mm

## Mark Specification (HSON-6)

①②③④ : Product Code .Refer to the marking list table

⑤⑥ : Lot No. ....Alphanumeric serial number.

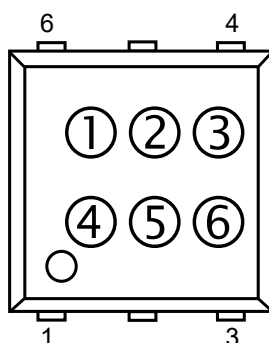



## R1173D Series Marking List Table

PKG : HSON-6

## R1173Dxx1B

Part Number	①②③④
R1173D081B	<b>H08B</b>
R1173D091B	<b>H09B</b>
R1173D101B	<b>H10B</b>
R1173D111B	<b>H11B</b>
R1173D121B	<b>H12B</b>
R1173D131B	<b>H13B</b>
R1173D141B	<b>H14B</b>
R1173D151B	<b>H15B</b>
R1173D161B	<b>H16B</b>
R1173D171B	<b>H17B</b>
R1173D181B	<b>H18B</b>
R1173D191B	<b>H19B</b>
R1173D201B	<b>H20B</b>
R1173D211B	<b>H21B</b>
R1173D221B	<b>H22B</b>
R1173D231B	<b>H23B</b>
R1173D241B	<b>H24B</b>
R1173D251B	<b>H25B</b>
R1173D261B	<b>H26B</b>
R1173D271B	<b>H27B</b>
R1173D281B	<b>H28B</b>
R1173D291B	<b>H29B</b>
R1173D301B	<b>H30B</b>
R1173D311B	<b>H31B</b>
R1173D321B	<b>H32B</b>
R1173D331B	<b>H33B</b>
R1173D341B	<b>H34B</b>
R1173D351B	<b>H35B</b>
R1173D361B	<b>H36B</b>
R1173D371B	<b>H37B</b>
R1173D381B	<b>H38B</b>
R1173D391B	<b>H39B</b>
R1173D401B	<b>H40B</b>
R1173D411B	<b>H41B</b>
R1173D421B	<b>H42B</b>
R1173D431B	<b>H43B</b>
R1173D441B	<b>H44B</b>
R1173D451B	<b>H45B</b>
R1173D461B	<b>H46B</b>
R1173D471B	<b>H47B</b>
R1173D481B	<b>H48B</b>
R1173D491B	<b>H49B</b>
R1173D501B	<b>H50B</b>
R1173D181B5	<b>H01B</b>
R1173D281B5	<b>H02B</b>
R1173D121B5	<b>H03B</b>
R1173D001B	<b>H00B</b>

## R1173Dxx1D

Part Number	①②③④
R1173D081D	<b>H08D</b>
R1173D091D	<b>H09D</b>
R1173D101D	<b>H10D</b>
R1173D111D	<b>H11D</b>
R1173D121D	<b>H12D</b>
R1173D131D	<b>H13D</b>
R1173D141D	<b>H14D</b>
R1173D151D	<b>H15D</b>
R1173D161D	<b>H16D</b>
R1173D171D	<b>H17D</b>
R1173D181D	<b>H18D</b>
R1173D191D	<b>H19D</b>
R1173D201D	<b>H20D</b>
R1173D211D	<b>H21D</b>
R1173D221D	<b>H22D</b>
R1173D231D	<b>H23D</b>
R1173D241D	<b>H24D</b>
R1173D251D	<b>H25D</b>
R1173D261D	<b>H26D</b>
R1173D271D	<b>H27D</b>
R1173D281D	<b>H28D</b>
R1173D291D	<b>H29D</b>
R1173D301D	<b>H30D</b>
R1173D311D	<b>H31D</b>
R1173D321D	<b>H32D</b>
R1173D331D	<b>H33D</b>
R1173D341D	<b>H34D</b>
R1173D351D	<b>H35D</b>
R1173D361D	<b>H36D</b>
R1173D371D	<b>H37D</b>
R1173D381D	<b>H38D</b>
R1173D391D	<b>H39D</b>
R1173D401D	<b>H40D</b>
R1173D411D	<b>H41D</b>
R1173D421D	<b>H42D</b>
R1173D431D	<b>H43D</b>
R1173D441D	<b>H44D</b>
R1173D451D	<b>H45D</b>
R1173D461D	<b>H46D</b>
R1173D471D	<b>H47D</b>
R1173D481D	<b>H48D</b>
R1173D491D	<b>H49D</b>
R1173D501D	<b>H50D</b>
R1173D181D5	<b>H01D</b>
R1173D281D5	<b>H02D</b>
R1173D121D5	<b>H03D</b>
R1173D001D	<b>H00D</b>

## Power Dissipation (HSOP-6J)

This specification is at mounted on board. Power Dissipation ( $P_D$ ) depends on conditions of mounting on board. This specification is based on the measurement at the condition below:

### Measurement Conditions

	High Wattage Land Pattern	Standard Land Pattern
Environment	Mounting on Board (Wind velocity=0m/s)	Mounting on Board (Wind velocity=0m/s)
Board Material	Glass cloth epoxy plastic (Double sided)	Glass cloth epoxy plastic (Double sided)
Board Dimensions	50mm x 50mm x 1.6mm	50mm x 50mm x 1.6mm
Copper Ratio	90%	50%
Through-hole	$\phi 0.5\text{mm} \times 24\text{pcs}$	$\phi 0.5\text{mm} \times 24\text{pcs}$

### Measurement Result

( $T_a=25^\circ\text{C}, T_{j\text{max}}=125^\circ\text{C}$ )

	High Wattage Land Pattern	Standard Land Pattern	Free Air
Power Dissipation	2000mW	1700mW	540mW
Thermal Resistance	$50^\circ\text{C/W}$	$59^\circ\text{C/W}$	$185^\circ\text{C/W}$

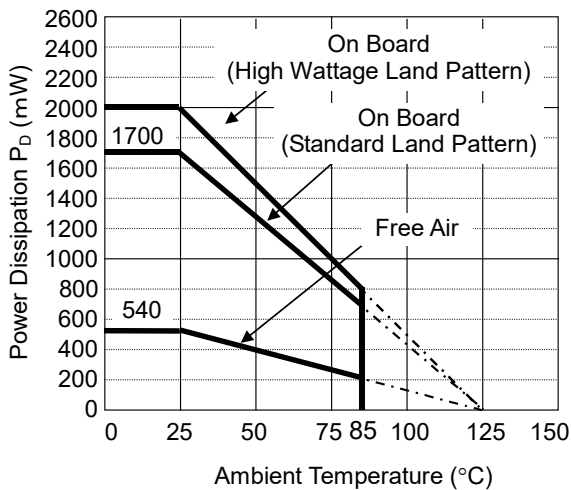

Power Dissipation

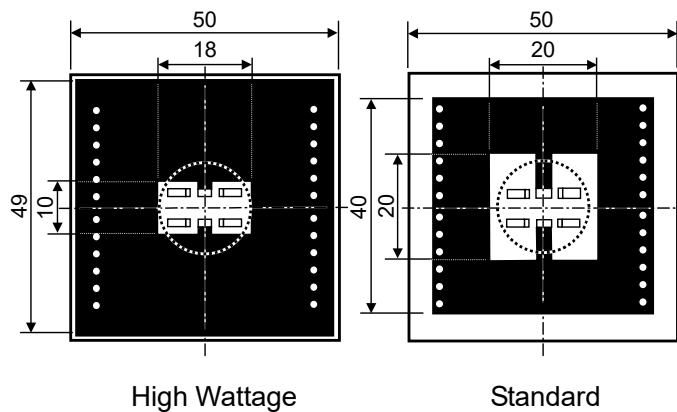

Measurement Board Pattern

IC Mount Area Unit : mm

### Package Dimensions (HSOP-6J)

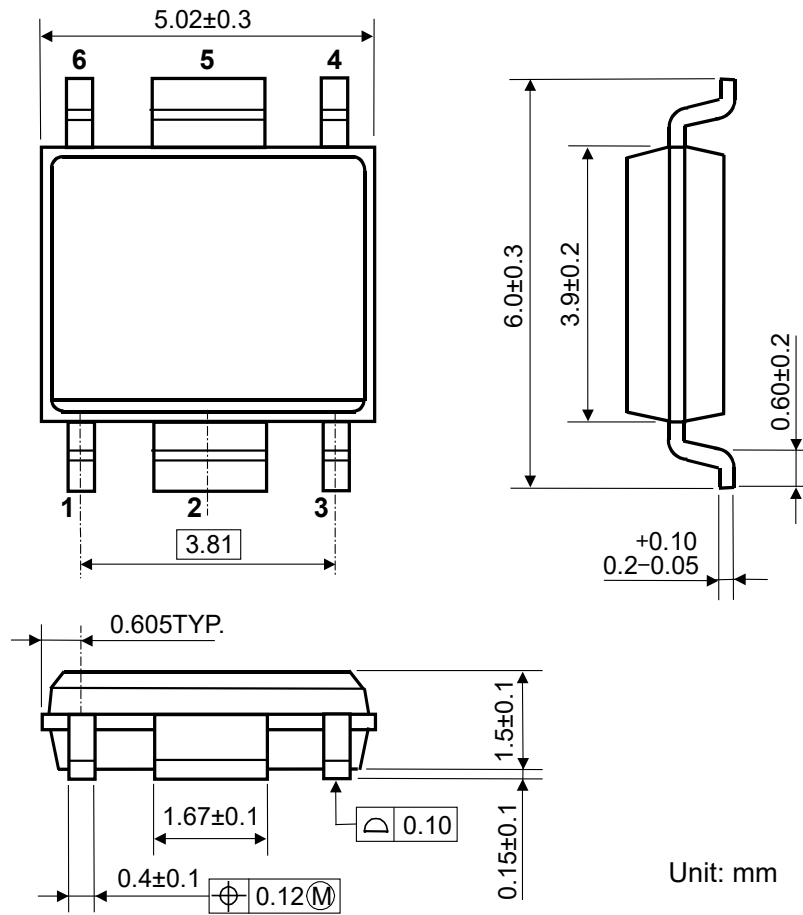

## Mark Specification (HSOP-6J)

①②③④ : Product Code..... Refer to the marking list table.

⑤⑥ : Lot No. .... Alphanumeric serial number.

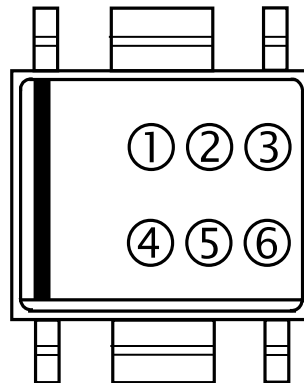

### R1173S Series Marking List Table

PKG : HSOP-6J

<b>R1173Sxx1B</b>		<b>R1173Sxx1D</b>	
Part Number	①②③④	Part Number	①②③④
R1173S081B	<b>C08B</b>	R1173S081D	<b>C08D</b>
R1173S091B	<b>C09B</b>	R1173S091D	<b>C09D</b>
R1173S101B	<b>C10B</b>	R1173S101D	<b>C10D</b>
R1173S111B	<b>C11B</b>	R1173S111D	<b>C11D</b>
R1173S121B	<b>C12B</b>	R1173S121D	<b>C12D</b>
R1173S131B	<b>C13B</b>	R1173S131D	<b>C13D</b>
R1173S141B	<b>C14B</b>	R1173S141D	<b>C14D</b>
R1173S151B	<b>C15B</b>	R1173S151D	<b>C15D</b>
R1173S161B	<b>C16B</b>	R1173S161D	<b>C16D</b>
R1173S171B	<b>C17B</b>	R1173S171D	<b>C17D</b>
R1173S181B	<b>C18B</b>	R1173S181D	<b>C18D</b>
R1173S191B	<b>C19B</b>	R1173S191D	<b>C19D</b>
R1173S201B	<b>C20B</b>	R1173S201D	<b>C20D</b>
R1173S211B	<b>C21B</b>	R1173S211D	<b>C21D</b>
R1173S221B	<b>C22B</b>	R1173S221D	<b>C22D</b>
R1173S231B	<b>C23B</b>	R1173S231D	<b>C23D</b>
R1173S241B	<b>C24B</b>	R1173S241D	<b>C24D</b>
R1173S251B	<b>C25B</b>	R1173S251D	<b>C25D</b>
R1173S261B	<b>C26B</b>	R1173S261D	<b>C26D</b>
R1173S271B	<b>C27B</b>	R1173S271D	<b>C27D</b>
R1173S281B	<b>C28B</b>	R1173S281D	<b>C28D</b>
R1173S291B	<b>C29B</b>	R1173S291D	<b>C29D</b>
R1173S301B	<b>C30B</b>	R1173S301D	<b>C30D</b>
R1173S311B	<b>C31B</b>	R1173S311D	<b>C31D</b>
R1173S321B	<b>C32B</b>	R1173S321D	<b>C32D</b>
R1173S331B	<b>C33B</b>	R1173S331D	<b>C33D</b>
R1173S341B	<b>C34B</b>	R1173S341D	<b>C34D</b>
R1173S351B	<b>C35B</b>	R1173S351D	<b>C35D</b>
R1173S361B	<b>C36B</b>	R1173S361D	<b>C36D</b>
R1173S371B	<b>C37B</b>	R1173S371D	<b>C37D</b>
R1173S381B	<b>C38B</b>	R1173S381D	<b>C38D</b>
R1173S391B	<b>C39B</b>	R1173S391D	<b>C39D</b>
R1173S401B	<b>C40B</b>	R1173S401D	<b>C40D</b>
R1173S411B	<b>C41B</b>	R1173S411D	<b>C41D</b>
R1173S421B	<b>C42B</b>	R1173S421D	<b>C42D</b>
R1173S431B	<b>C43B</b>	R1173S431D	<b>C43D</b>
R1173S441B	<b>C44B</b>	R1173S441D	<b>C44D</b>
R1173S451B	<b>C45B</b>	R1173S451D	<b>C45D</b>
R1173S461B	<b>C46B</b>	R1173S461D	<b>C46D</b>
R1173S471B	<b>C47B</b>	R1173S471D	<b>C47D</b>
R1173S481B	<b>C48B</b>	R1173S481D	<b>C48D</b>
R1173S491B	<b>C49B</b>	R1173S491D	<b>C49D</b>
R1173S501B	<b>C50B</b>	R1173S501D	<b>C50D</b>
R1173S181B5	<b>C01B</b>	R1173S181D5	<b>C01D</b>
R1173S281B5	<b>C02B</b>	R1173S281D5	<b>C02D</b>
R1173S121B5	<b>C03B</b>	R1173S121D5	<b>C03D</b>
R1173S001B	<b>C00B</b>	R1173S001D	<b>C00D</b>

1. The products and the product specifications described in this document are subject to change or discontinuation of production without notice for reasons such as improvement. Therefore, before deciding to use the products, please refer to our sales representatives for the latest information thereon.
2. The materials in this document may not be copied or otherwise reproduced in whole or in part without the prior written consent of us.
3. This product and any technical information relating thereto are subject to complementary export controls (so-called KNOW controls) under the Foreign Exchange and Foreign Trade Law, and related politics ministerial ordinance of the law. (Note that the complementary export controls are inapplicable to any application-specific products, except rockets and pilotless aircraft, that are insusceptible to design or program changes.) Accordingly, when exporting or carrying abroad this product, follow the Foreign Exchange and Foreign Trade Control Law and its related regulations with respect to the complementary export controls.
4. The technical information described in this document shows typical characteristics and example application circuits for the products. The release of such information is not to be construed as a warranty of or a grant of license under our or any third party's intellectual property rights or any other rights.
5. The products listed in this document are intended and designed for use as general electronic components in standard applications (office equipment, telecommunication equipment, measuring instruments, consumer electronic products, amusement equipment etc.). Those customers intending to use a product in an application requiring extreme quality and reliability, for example, in a highly specific application where the failure or misoperation of the product could result in human injury or death should first contact us.
  - Aerospace Equipment
  - Equipment Used in the Deep Sea
  - Power Generator Control Equipment (nuclear, steam, hydraulic, etc.)
  - Life Maintenance Medical Equipment
  - Fire Alarms / Intruder Detectors
  - Vehicle Control Equipment (automotive, airplane, railroad, ship, etc.)
  - Various Safety Devices
  - Traffic control system
  - Combustion equipment

In case your company desires to use this product for any applications other than general electronic equipment mentioned above, make sure to contact our company in advance. Note that the important requirements mentioned in this section are not applicable to cases where operation requirements such as application conditions are confirmed by our company in writing after consultation with your company.

6. We are making our continuous effort to improve the quality and reliability of our products, but semiconductor products are likely to fail with certain probability. In order to prevent any injury to persons or damages to property resulting from such failure, customers should be careful enough to incorporate safety measures in their design, such as redundancy feature, fire containment feature and fail-safe feature. We do not assume any liability or responsibility for any loss or damage arising from misuse or inappropriate use of the products.
7. The products have been designed and tested to function within controlled environmental conditions. Do not use products under conditions that deviate from methods or applications specified in this datasheet. Failure to employ the products in the proper applications can lead to deterioration, destruction or failure of the products. We shall not be responsible for any bodily injury, fires or accident, property damage or any consequential damages resulting from misuse or misapplication of the products.
8. **Quality Warranty**
  - 8-1. **Quality Warranty Period**

In the case of a product purchased through an authorized distributor or directly from us, the warranty period for this product shall be one (1) year after delivery to your company. For defective products that occurred during this period, we will take the quality warranty measures described in section 8-2. However, if there is an agreement on the warranty period in the basic transaction agreement, quality assurance agreement, delivery specifications, etc., it shall be followed.
  - 8-2. **Quality Warranty Remedies**

When it has been proved defective due to manufacturing factors as a result of defect analysis by us, we will either deliver a substitute for the defective product or refund the purchase price of the defective product.

Note that such delivery or refund is sole and exclusive remedies to your company for the defective product.
  - 8-3. **Remedies after Quality Warranty Period**

With respect to any defect of this product found after the quality warranty period, the defect will be analyzed by us. On the basis of the defect analysis results, the scope and amounts of damage shall be determined by mutual agreement of both parties. Then we will deal with upper limit in Section 8-2. This provision is not intended to limit any legal rights of your company.
9. Anti-radiation design is not implemented in the products described in this document.
10. The X-ray exposure can influence functions and characteristics of the products. Confirm the product functions and characteristics in the evaluation stage.
11. WLCSP products should be used in light shielded environments. The light exposure can influence functions and characteristics of the products under operation or storage.
12. Warning for handling Gallium and Arsenic (GaAs) products (Applying to GaAs MMIC, Photo Reflector). These products use Gallium (Ga) and Arsenic (As) which are specified as poisonous chemicals by law. For the prevention of a hazard, do not burn, destroy, or process chemically to make them as gas or power. When the product is disposed of, please follow the related regulation and do not mix this with general industrial waste or household waste.
13. Please contact our sales representatives should you have any questions or comments concerning the products or the technical information.



**Nisshinbo Micro Devices Inc.**

**Official website**

<https://www.nisshinbo-microdevices.co.jp/en/>

**Purchase information**

<https://www.nisshinbo-microdevices.co.jp/en/buy/>

## X-ON Electronics

Largest Supplier of Electrical and Electronic Components

*Click to view similar products for [LDO Voltage Regulators](#) category:*

*Click to view products by [Nisshinbo](#) manufacturer:*

Other Similar products are found below :

[AP7363-SP-13](#) [NCV8664CST33T3G](#) [L79M05TL-E](#) [AP7362-HA-7](#) [PT7M8202B12TA5EX](#) [TCR3DF185,LM\(CT](#) [TLF4949EJ](#)  
[NCP4687DH15T1G](#) [NCV8703MX30TCG](#) [LP2951CN](#) [NCV4269CPD50R2G](#) [AP7315-25W5-7](#) [NCV47411PAAJR2G](#) [AP2111H-1.2TRG1](#)  
[ZLDO1117QK50TC](#) [AZ1117ID-ADJTRG1](#) [NCV4263-2CPD50R2G](#) [NCP706ABMX300TAG](#) [NCP114BMX075TCG](#) [MC33269T-3.5G](#)  
[TLE4471GXT](#) [AP7315-33SA-7](#) [NCV4266-2CST33T3G](#) [NCP715SQ15T2G](#) [NCV8623MN-50R2G](#) [NCV563SQ18T1G](#) [NCV8664CDT33RKG](#)  
[NCV4299CD250R2G](#) [NCP715MX30TBG](#) [NCV8702MX25TCG](#) [TLE7270-2E](#) [NCV562SQ25T1G](#) [AP2213D-3.3TRG1](#) [AP2202K-2.6TRE1](#)  
[NCV8170BMX300TCG](#) [NCV8152MX300180TCG](#) [NCP700CMT45TBG](#) [AP7315-33W5-7](#) [NCP154MX180300TAG](#) [AP2113AMTR-G1](#)  
[NJW4104U2-33A-TE1](#) [MP2013AGG-5-P](#) [NCV8775CDT50RKG](#) [NJM2878F3-45-TE1](#) [S-19214B00A-V5T2U7](#) [S-19214B50A-V5T2U7](#) [S-](#)  
[19213B50A-V5T2U7](#) [S-19214BC0A-E8T1U7\\*1](#) [S-19213B00A-V5T2U7](#) [S-19213B33A-V5T2U7](#)