1.2 A, 30 V Step-Down DC/DC Converter

NO.EA-190-170609

OUTLINE

The R1240x is a CMOS-based Step-down DC/DC converter with internal Nch high side Tr. (0.35Ω), which can provide the maximum 1.2 A output current. The ICs consists of an Oscillator, a PWM control circuit, a Reference Voltage unit, an Error amplifier, phase compensation circuits, a slope circuit, a soft-start circuit, protection circuits, internal voltage regulators, and a switch for boot strap circuit. The ICs can make up a Step-Down DC/DC Converter with the following external components: an inductor, resistors, a diode, and capacitors. The R1240x is a current mode operating type DC/DC converter which does not require external current sense resistor, and it works high speed response time, high efficiency and compatible with ceramic capacitors. Oscillator frequency is internally set at 1.25 MHz.

As a protection function, it has cycle by cycle peak current limit function, short protection function, thermal shutdown function and UVLO.

There are two types for short protection, A version has latch protection function with 2 ms delay time, and B version has fold-back protection function that keep operating at short condition with lower operating frequency and limiting the Lx current.

FEATURES

- Operating Voltage 4.5 V to 30 V
- Internal Nch MOSFET Driver Typ. $R_{ON} = 0.35 \Omega$
- Adjustable Output Voltage with External Resistor ... 0.8 V to 15 V
- Feedback Voltage $0.8 V \pm 1.5\%$
- Peak Current Limit Function Typ. 2.0 A
- UVLO Function
- Operating Frequency 1.25 MHz (Ver. B: 310 kHz, Fold-back Condition)
- Short Protection for Output Ver. A: Latch with 2 ms delay or Ver. B: Fold-back
- Ceramic Capacitor Compatible
- Stand-by Function Typ. $0 \mu A$
- Package SOT-23-6W, DFN(PLP)2527-10

APPLICATIONS

- Digital Home Appliances: Digital TVs, DVD Players
- OA Equipment: Printers, Fax
- Hand-held Communication Equipment, Cameras, VCRs, Camcorders
- Battery-powered Equipment

R1240x

NO.EA-190-170609

SELECTION GUIDE

In the R1240x, the Package, type of short protection (Latch or Fold-back) can be selected at the user's request.

Selection Guide

Product Name	Package	Quantity per Reel	Pb Free	Halogen Free
R1240K003*-TR	DFN(PLP)2527-10	5,000 pcs	Yes	Yes
R1240N001*-TR-FE	SOT-23-6W	3,000 pcs	Yes	Yes

*: Designation of Optional Function at off state are options as follows.

- (A) Latch Type protection
- (B) Fold-back Type protection

BLOCK DIAGRAM

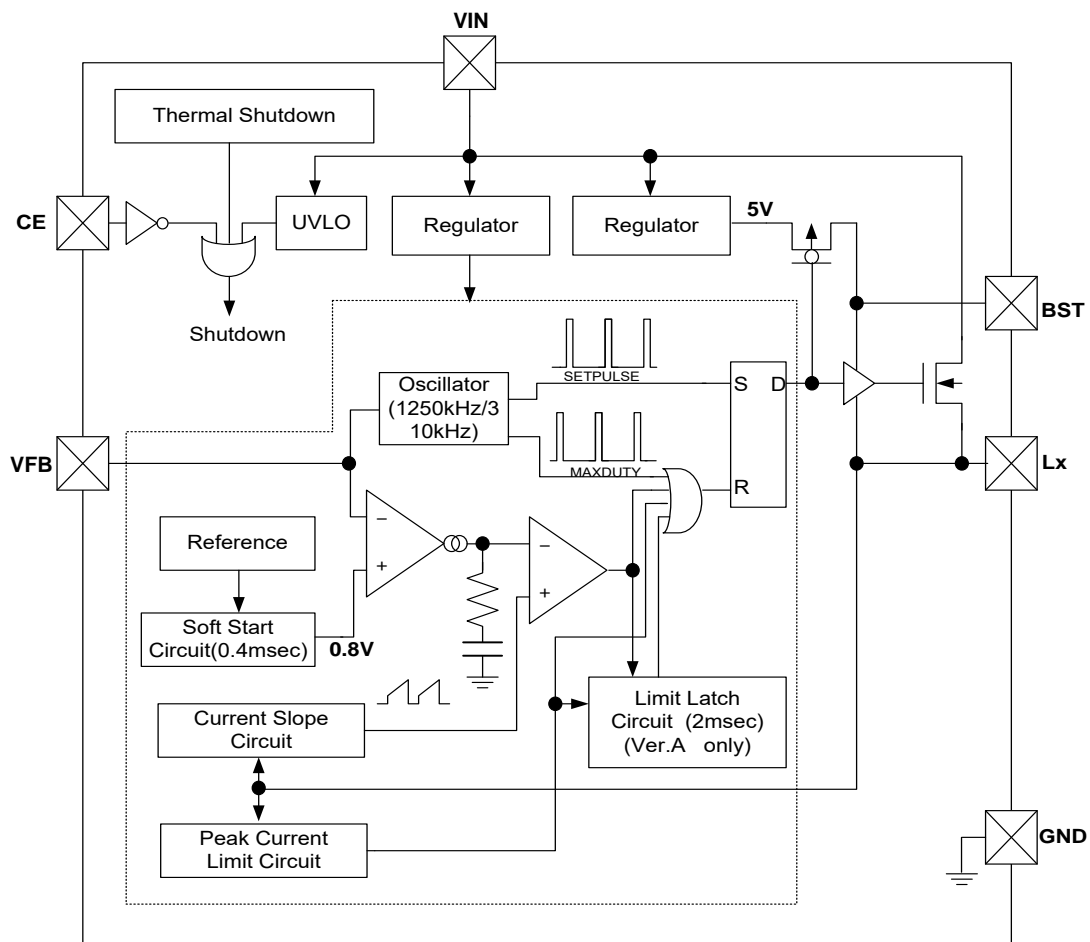

R1240x Block Diagram

PIN DESCRIPTIONS

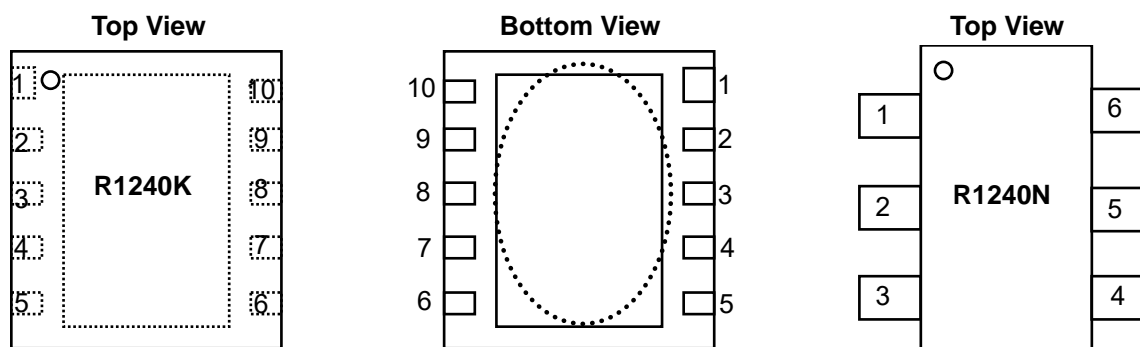

DFN(PLP)2527-10 Pin Configuration

SOT-23-6W Pin Configuration

R1240N001x Pin Description

Pin No.	Symbol	Description
1	CE	Chip Enable Pin, Active with "H"
2	VIN	Power Supply Pin
3	Lx	Lx Switching Pin
4	BST	Bootstrap Pin
5	GND	Ground Pin
6	VFB	Feedback Pin

R1240K003x Pin Description

Pin No.	Symbol	Description
1	Lx	Lx Switching Pin
2	VIN	Power Supply Pin
3	VIN	Power Supply Pin
4	CE	Chip Enable Pin, Active with "H"
5	TEST	Test Pin (Open, do not connect to any line.)
6	GND	Ground Pin
7	NC	No Connection
8	VFB	Feedback Pin
9	NC	No Connection
10	BST	Bootstrap Pin

Tab is GND level. (They are connected to the reverse side of this IC.) The tab is better to be connected to the GND, but leaving it open is also acceptable.

R1240x

NO.EA-190-170609

ABSOLUTE MAXIMUM RATINGS

Absolute Maximum Ratings

(GND = 0 V)

Symbol	Item	Rating	Unit		
V _{IN}	Input Voltage	-0.3 to 32	V		
V _{BST}	BST Pin Voltage	V _{LX} -0.3 to V _{LX} +6	V		
V _{LX}	Lx Pin Voltage	-0.3 to V _{IN} +0.3	V		
I _{LX}	Lx Pin Current	2	A		
V _{CE}	CE Pin input Voltage	-0.3 to V _{IN} + 0.3	V		
V _{FB}	VFB Pin Voltage	-0.3 to 4	V		
P _D	Power Dissipation*	SOT-23-6W	Standard Land Pattern	430	mW
		DFN(PLP)2527-10	Standard Land Pattern	910	
			High Wattage Land Pattern	1400	
T _j	Junction Temperature Range	-40 to 125	°C		
T _{stg}	Storage Temperature Range	-55 to 125	°C		

* Refer to *Power Dissipation* for detailed information.

ABSOLUTE MAXIMUM RATINGS

Electronic and mechanical stress momentarily exceeded absolute maximum ratings may cause the permanent damages and may degrade the life time and safety for both device and system using the device in the field. The functional operation at or over these absolute maximum ratings is not assured.

RECOMMENDED OPERATING CONDITIONS

Recommended Operating Conditions

Symbol	Item	Rating	Unit
V _{IN}	Operating Input Voltage	4.5 to 30	V
T _a	Operating Temperature Range	-40 to 85	°C

RECOMMENDED OPERATING CONDITIONS

All of electronic equipment should be designed that the mounted semiconductor devices operate within the recommended operating conditions. The semiconductor devices cannot operate normally over the recommended operating conditions, even if when they are used over such conditions by momentary electronic noise or surge. And the semiconductor devices may receive serious damage when they continue to operate over the recommended operating conditions.

ELECTRICAL CHARACTERISTICS

Electrical Characteristics

(Otherwise notified, $V_{IN} = 12\text{ V}$, $T_a = 25^\circ\text{C}$)

Symbol	Item	Conditions	Min.	Typ.	Max.	Unit
I_{IN}	VIN Consumption Current	$V_{IN} = 30\text{ V}$, $V_{FB} = 1.0\text{ V}$		0.5	1.0	mA
V_{UVLO1}	UVLO Detect Voltage	Falling	3.6	3.8	4.0	V
V_{UVLO2}	UVLO Released Voltage	Rising		$V_{UVLO1} + 0.2$	4.2	V
V_{FB}	VFB Voltage Tolerance		0.788	0.800	0.812	V
$\Delta V_{FB}/\Delta T_a$	VFB Voltage Temperature Coefficient	$-40^\circ\text{C} \leq T_a \leq 85^\circ\text{C}$		± 150		ppm/ $^\circ\text{C}$
fosc	Oscillator Frequency		1000	1250	1500	kHz
V_{FLB}	Fold-back Frequency (Ver. B)	$V_{FB} < 0.56\text{ V}$		310		kHz
Maxduty	Oscillator Max. Duty Cycle		75	85	90	%
tmin	Minimum On Time			100		nsec
tss	Soft-start Time	$V_{FB} = 0.72\text{ V}$	0.2	0.4	0.6	ms
tdly	Delay Time for Latch Protection (Ver. A)		1	2	4	ms
R_{LXH}	Lx High Side Switch ON Resistance			0.35		Ω
I_{LXHOFF}	Lx High Side Switch Leakage Current			0	5	μA
I_{LIMLXH}	Lx High Side Switch Limited Current			2.0		A
V_{CEL}	CE "L" Input Voltage				0.3	V
V_{CEH}	CE "H" Input Voltage		1.6			V
I_{FB}	VFB Input Current		-1.0		1.0	μA
I_{CEL}	CE "L" Input Current		-1.0		1.0	μA
I_{CEH}	CE "H" Input Current		-1.0		1.0	μA
T_{TSD}	Thermal Shutdown Detect Temperature	Hysteresis 30°C		160		$^\circ\text{C}$
Istandby	Standby Current	$V_{IN} = 30\text{ V}$		0	5	μA

OPERATING DESCRIPTIONS

OPERATION OF STEP-DOWN DC/DC CONVERTER AND OUTPUT CURRENT

The step-down DC/DC converter charges energy in the inductor (L) when the LX transistor turns on, and discharges the energy from the inductor when LX transistor turns off and controls with less energy loss, so that a lower output voltage (V_{OUT}) than the input voltage (V_{IN}) can be obtained. The operation of the step-down DC/DC converter is explained in the following figures.

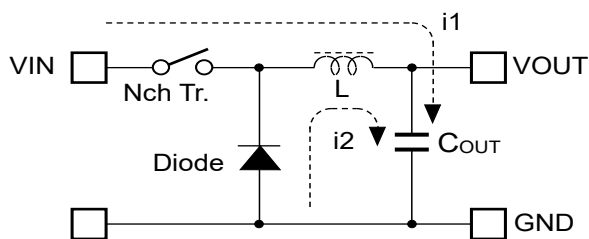

Basic Circuit

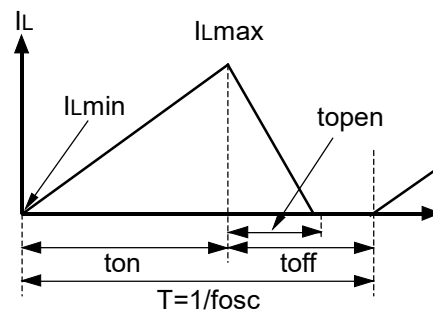

Inductor Current flowing through Inductor

- Step1.** The Nch transistor turns on and the inductor current (i_1) flows, L is charged with energy. At this moment, i_1 increases from the minimum inductor current (I_{Lmin}), which is 0 A, and reaches the maximum inductor current (I_{Lmax}) in proportion to the on-time period (t_{on}) of the Nch transistor.
- Step2.** When the Nch transistor turns off, L tries to maintain I_L at I_{Lmax} , so L turns the diode on and the inductor current (i_2) flows into L.
- Step3.** i_2 decreases gradually and reaches I_{Lmin} after the open-time period (t_{open}) of the Nch transistor, and then the diode turns off. This is called discontinuous current mode.
- As the output current (I_{OUT}) increases, the off-time period (t_{off}) of the Nch transistor runs out before I_L reaches I_{Lmin} . The next cycle starts, and the Nch transistor turns on and the diode turns off, which means I_L starts increasing from I_{Lmin} . This is called continuous current mode.

In the case of PWM mode, V_{OUT} is maintained by controlling t_{on} . During PWM mode, the oscillator frequency (f_{osc}) is being maintained constant.

APPLICATION INFORMATION

TYPICAL APPLICATION CIRCUIT

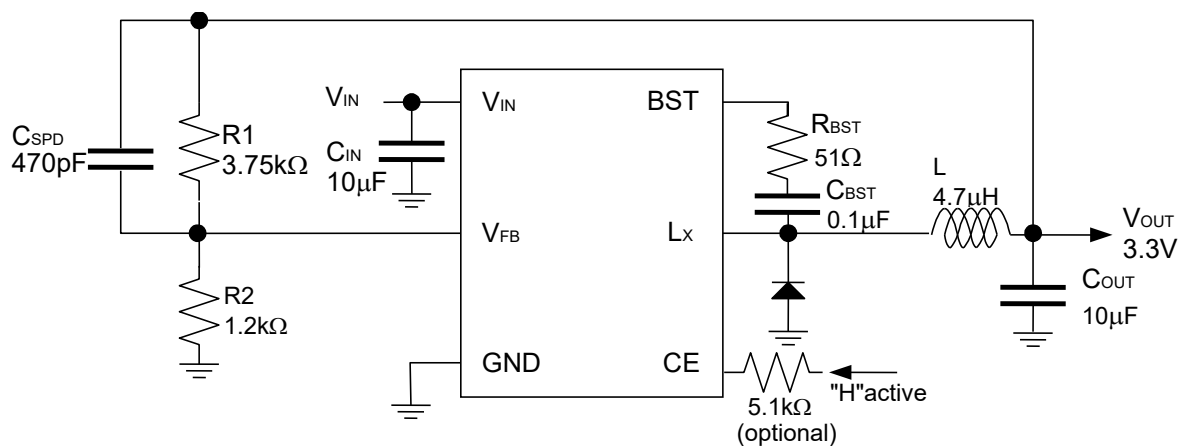

R1240x Typical Application Circuit

External Parts

C_{IN}	10 μ F, KTS500B106M55N0T00 (Nippon Chemi-Con)
C_{OUT}	10 μ F, GRM31CR71E106K (Murata)
C_{BST}	0.1 μ F, GRM21BB11H104KA01L (Murata)
L	4.7 μ H, SLF7045T-4R7M2R0-PF (TDK)
D	CMS11 (Toshiba)

OUTPUT CURRENT AND SELECTION OF EXTERNAL COMPONENTS

The following equations explain the relationship between output current and peripheral components.

Ripple Current P-P value is described as I_{RP} , ON resistance of switch is described as R_{ONP} , forward drop voltage is described as V_F , and DC resistance of inductor is described as R_L .

First, when the switch is turned on, the following equation is satisfied.

$$V_{IN} = V_{OUT} + (R_{ONH} + R_L) \times I_{OUT} + L \times I_{RP} / t_{on} \dots\dots\dots \text{Equation 1}$$

Second, when the switch is turned off, the diode is turned on, the following equation is satisfied.

$$L \times I_{RP} / t_{off} = V_F + V_{OUT} + R_L \times I_{OUT} \dots\dots\dots \text{Equation 2}$$

Put Equation 2 into Equation 1 to solve the ON duty of the switch ($D_{ON} = t_{on} / (t_{off} + t_{on})$):

$$D_{ON} = (V_{OUT} + V_F + R_L \times I_{OUT}) / (V_{IN} + V_F - R_{ONH} \times I_{OUT}) \dots\dots\dots \text{Equation 3}$$

Ripple Current is described as follows:

$$I_{RP} = (V_{IN} - V_{OUT} - R_{ONH} \times I_{OUT} - R_L \times I_{OUT}) \times D_{ON} / f_{osc} / L \dots\dots\dots \text{Equation 4}$$

Peak current that flows through L and the switch is described as follows:

$$I_{Lmax} = I_{OUT} + I_{RP} / 2 \dots\dots\dots \text{Equation 5}$$

Notes: Please consider I_{Lmax} when setting conditions of input and output, as well as selecting the external components. The above calculation formulas are based on the ideal operation of the ICs in continuous mode.

TECHNICAL NOTES

The performance of a power source circuit using this device is highly dependent on a peripheral circuit. A peripheral component or the device mounted on PCB should not exceed its voltage, current or power ratings. When designing a peripheral circuit, please be fully aware of the following points. (Refer to our PCB layout for detailed information).

- External components must be connected as close as possible to the ICs and make wiring as short as possible. Especially, the capacitor connected in between VIN and GND pin must be wiring the shortest. The operating may be unstable due to the change of the electric potential of internal ICs by the switching current when the impedance of the power supply line and GND line is high. Make the power supply and GND lines sufficient. It is also necessary to give careful consideration to design the wiring of the power supply, GND, Lx, VOUT and the inductor because of the large current by the function of switching is flowing into them. Besides, the wiring between the resistance (R1), which set the output voltage, and the wiring of the inductor must separate from the load wiring.
- The ceramic capacitors have low ESR (Equivalent Series Resistance) type are recommended for the ICs. The recommendation of C_{IN} capacitor between VIN and GND is more than 10 μF, and C_{OUT} capacitor is more than 10 μF in the case V_{OUT} ≥ 1.8 V or more than 20 μF in the case 1.8 V > V_{OUT}. Please check the bias dependence and the temperature variations of the ceramic capacitors.
- Normally, please select the inductor value in the range between 4.7 μH and 10μH in the case of V_{OUT} ≥ 5 V, 4.7 μH in the case of 5 V > V_{OUT} ≥ 1.8 V and 2.2 μH in the case of 1.8 V > V_{OUT}. The internal phase compensation of this IC is designed with the above-mentioned inductor value and C_{OUT} ceramic capacitor value. When the inductor value is small, there is a possibility to trigger the over-current protection circuit by the peak switching current. As the peak switching current might reach to the limited value when the load current increase a lot.
- Please note; the over-current protection circuit is influenced by the temperature shift caused by operation of the IC.
- For the diode, please use the Schottky diode, which parasitic capacitance is small as possible, as, there is a possibility that the operating of IC becomes unstable by the large switching current.
- Output voltage is set by $V_{OUT} = V_{FB} \times (R1 + R2) / R2$. If the values of R1 and R2 are large, the impedance of VFB pin increases, and pickup the noise may result. The recommendation value range of R2 is approximately between 1.2 kΩ to 16 kΩ. If the operation may be unstable, reduce the impedance of VFB pin.

R1240x

NO.EA-190-170609

Recommended Value for Each Output Voltage

V _{OUT} (V)	0.8	1	1.2	1.3	1.5	1.8~6	6~15
R1 (kΩ)	0	$= (V_{OUT} / 0.8 - 1) \times 1.2$					
R2 (kΩ)	open	1.20	1.20	1.20	1.20	1.20	1.20
C _{SPD} (pF)	open	3300	2200	1500	470	470	330
C _{OUT} (μF)	22 × 2	10 × 2	10 × 2	10 × 2	10 × 2	10	10
L (μH)	2.2	2.2	2.2	2.2	2.2	4.7	10.0 (4.7)

Recommended External Components

Symbol	Condition	Value	Parts Name	MFR
C _{IN}		10 μF/ 50 V 10 μF/ 50 V 10 μF/ 50 V	UMK325BJ106MM-P CGA6P3X7S1H106K KTS500B106M55N0T00	TAIYO YUDEN TDK Nippon Chemi-Con
C _{OUT}	V _{OUT} > 10 V 10 V > V _{OUT} > 1.8 V V _{OUT} < 1.8 V	10 μF/ 50 V 10 μF/ 50 V 10 μF/ 50 V 10 μF/ 25 V 22 μF/ 10 V	UMK325BJ106MM-P CGA6P3X7S1H106K KTS500B106M55N0T00 GRM31CR71E106K GRM31CR71A226M NOTE: The value of C _{OUT} depends on the setting output voltage.	TAIYO YUDEN TDK Nippon Chemi-Con Murata Murata
C _{BST}		0.1 μF/ 50 V	GRM21BB11H104KA01L	Murata
R _{BST}		51.0 Ω		
L	40 V/ 2.0 A	10 μH 4.7 μH 2.2 μH	SLF6045T-100M1R6-3PF SLF7045T-4R7M2R0-PF VLCF4020T-2R2N1R7	TDK TDK TDK
D	30 V/ 2.0 A 40 V/ 2.0 A	0.32 V 0.49 V	CMS06 CMS11 NOTE: Diode depends on the input voltage and output Current.	TOSHIBA TOSHIBA
R _{CE}	The diode is connected between the CE pin and the VIN pin as the ESD protection element. If there is the possibility that the voltage of the CE pin becomes higher than the voltage of the VIN pin, it is recommended to connect the 5 kΩ resistance with the CE pin for preventing a large current flows into the VIN pin from the CE pin.			

THE NOTE OF LAYOUT PATTERN

1. The wire of Power line (V_{IN} , GND) should be broad to minimize the parasitic inductance.
The Bypass capacitor must be connected as close as possible in between V_{IN} – GND
2. The wire between Lx pin and the inductor as short as possible to minimize the parasitic inductance
(This Evaluation Board is designed for the product evaluation board. Therefore large inductors or diodes can be set and the large space of Lx area has been secured.)
3. The ripple current flows through the output capacitor. If the GND side of the output capacitor is connected very close to GND pin of the IC, the noise might have a bad impact on the IC. Therefore, the GND side of the output capacitor is better to connect to the outside of the GND of the C_{IN} , or connect to the GND plain layer.
4. R1, R2, Cspd and Rspd should be mounted on the position as close as possible to the FB pin, and away from the inductor and BST pin.
5. The feed-back must be made as close as possible from the Output capacitor (C_{OUT})

R1240x

NO.EA-190-170609

PCB LAYOUT

Evaluation board of R1240N001x

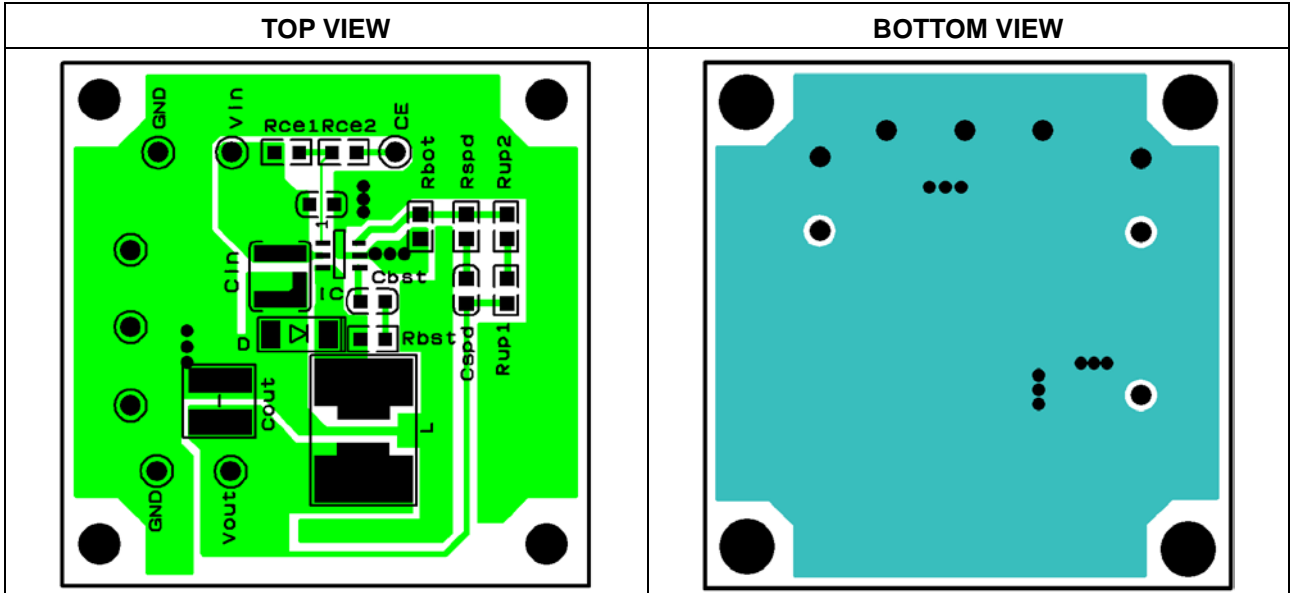

Evaluation board of R1240K003x

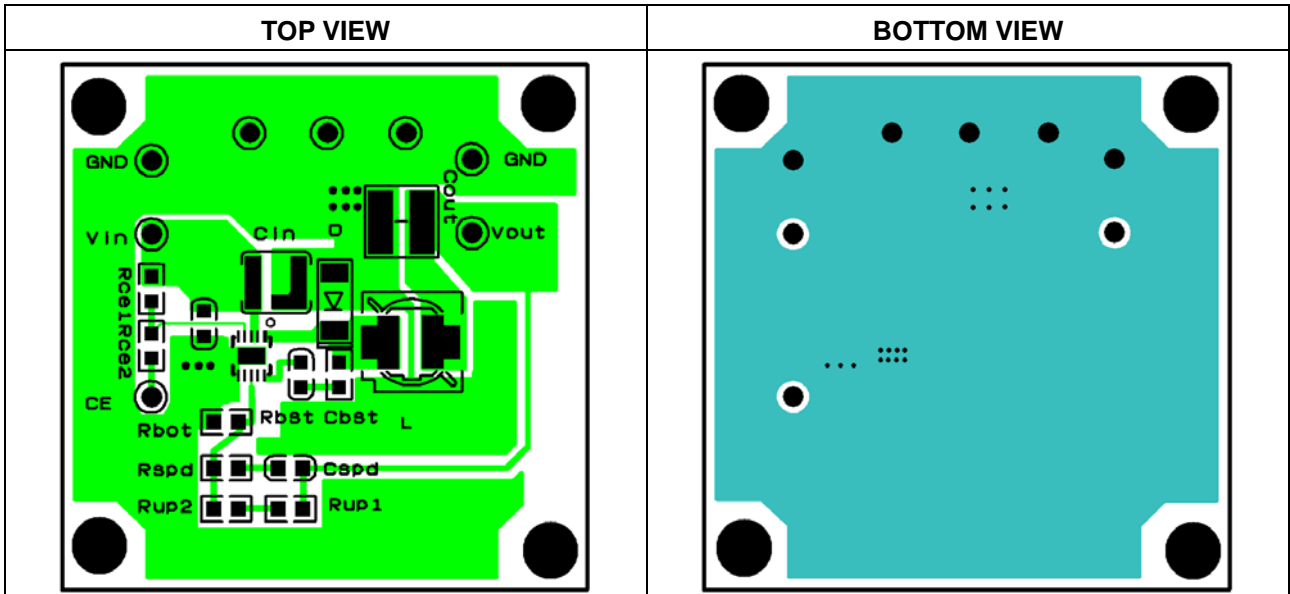

TYPICAL CHARACTERISTICS

1) Output Voltage VS. Output Current

R1240x00Xx

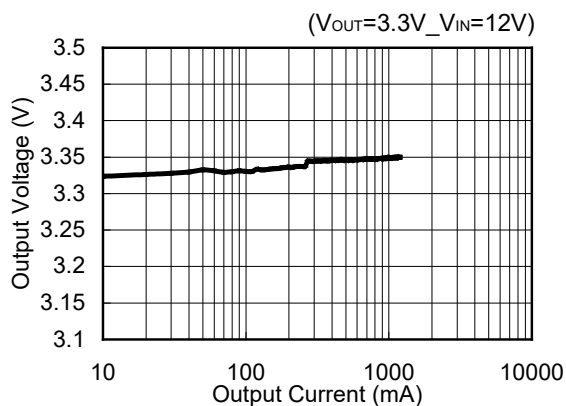

R1240x00Xx

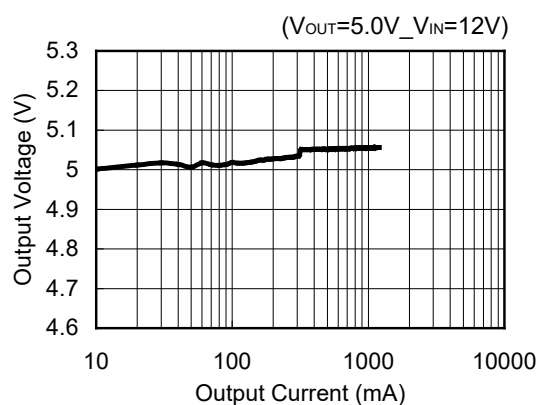

2) Output Voltage VS. Input Voltage

R1240x00Xx

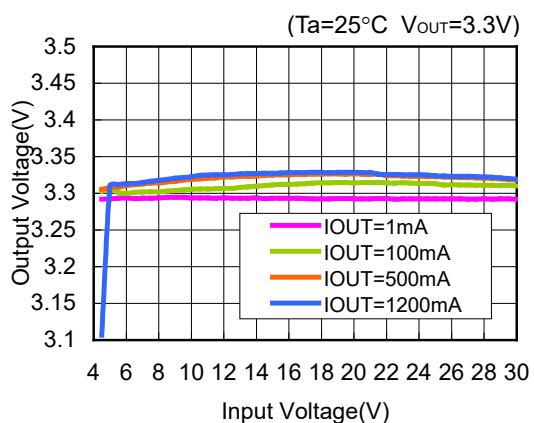

R1240x00Xx

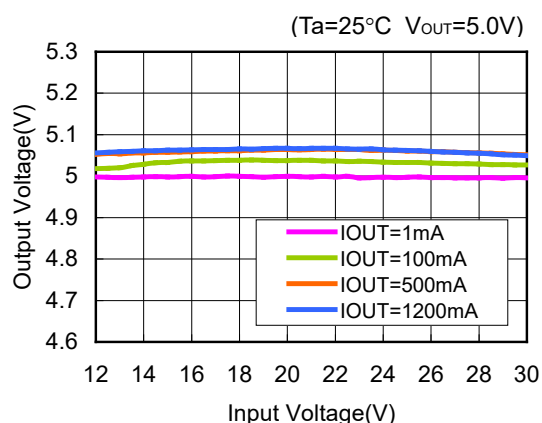

3) Efficiency VS. output Current

R1240x00Xx

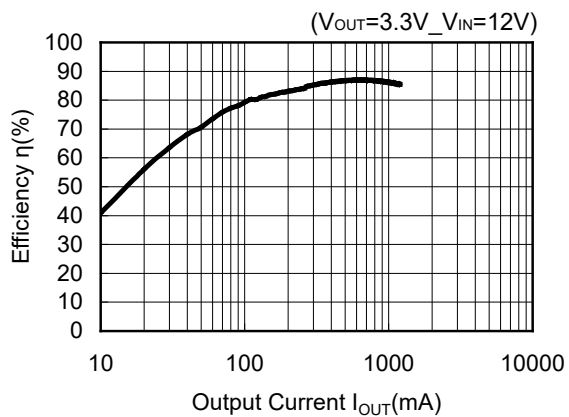

R1240x00Xx

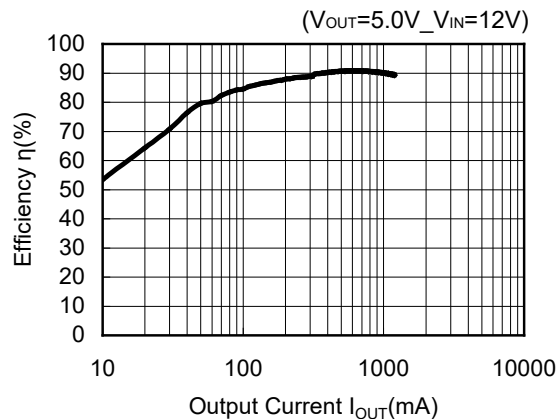

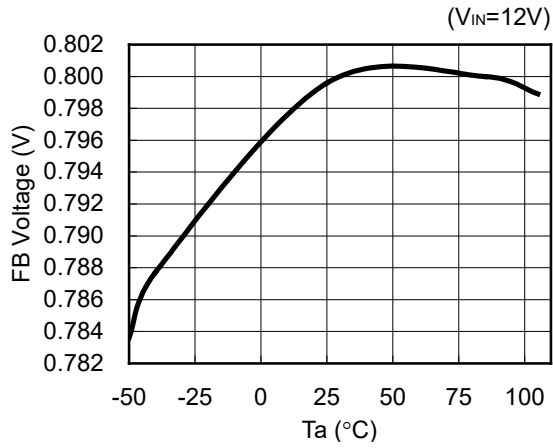
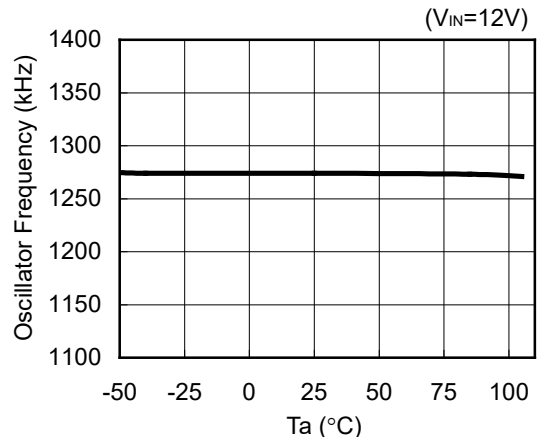
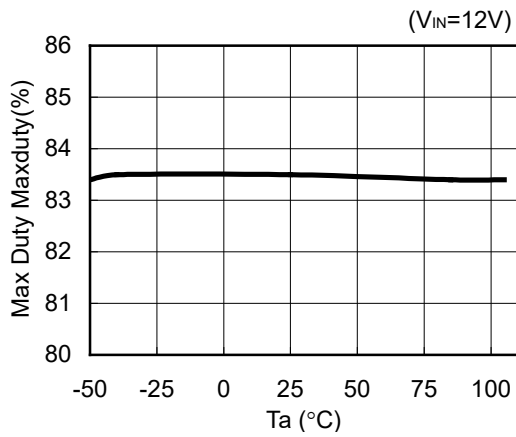
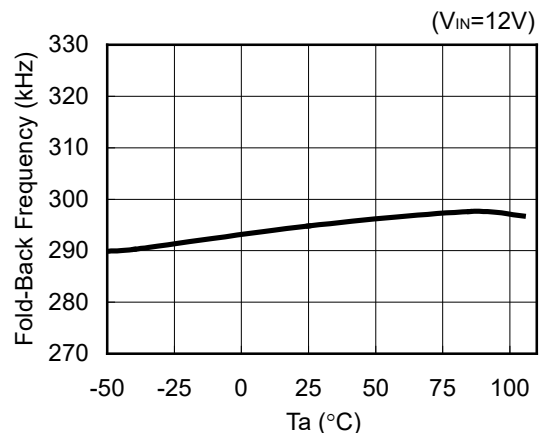
**4) FB Voltage VS. Temperature
R1240x00Xx****5) Oscillator Frequency VS. Temperature
R1240x00Xx****6) Maxduty VS. Temperature
R1240x00Xx****7) Fold-Back Frequency VS. Temperature
R1240x00XB**

The power dissipation of the package is dependent on PCB material, layout, and environmental conditions. The following conditions are used in this measurement.

Measurement Conditions

	Standard Test Land Pattern
Environment	Mounting on Board (Wind Velocity = 0 m/s)
Board Material	Glass Cloth Epoxy Plastic (Double-Sided Board)
Board Dimensions	40 mm × 40 mm × 1.6 mm
Copper Ratio	Top Side: Approx. 50% Bottom Side: Approx. 50%
Through-holes	φ 0.5 mm × 44 pcs

Measurement Result

(Ta = 25°C, Tjmax = 125°C)

	Standard Test Land Pattern
Power Dissipation	430 mW
Thermal Resistance	$\theta_{ja} = (125 - 25^\circ\text{C}) / 0.43 \text{ W} = 233^\circ\text{C/W}$

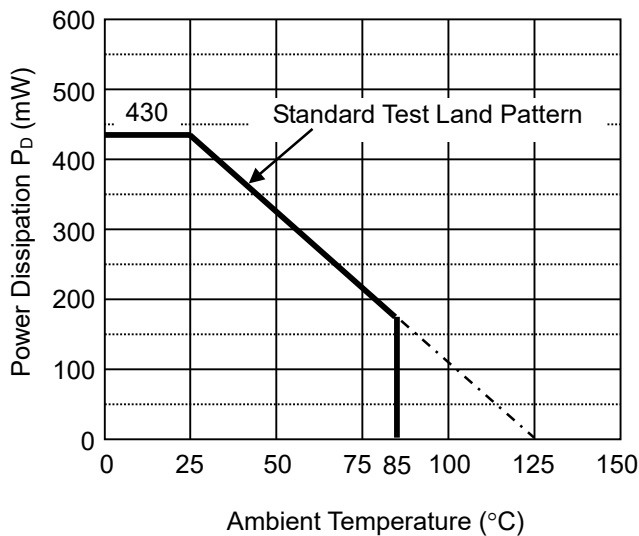

Power Dissipation vs. Ambient Temperature

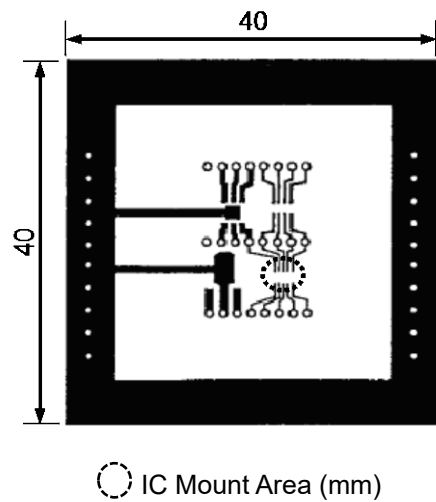

Measurement Board Pattern

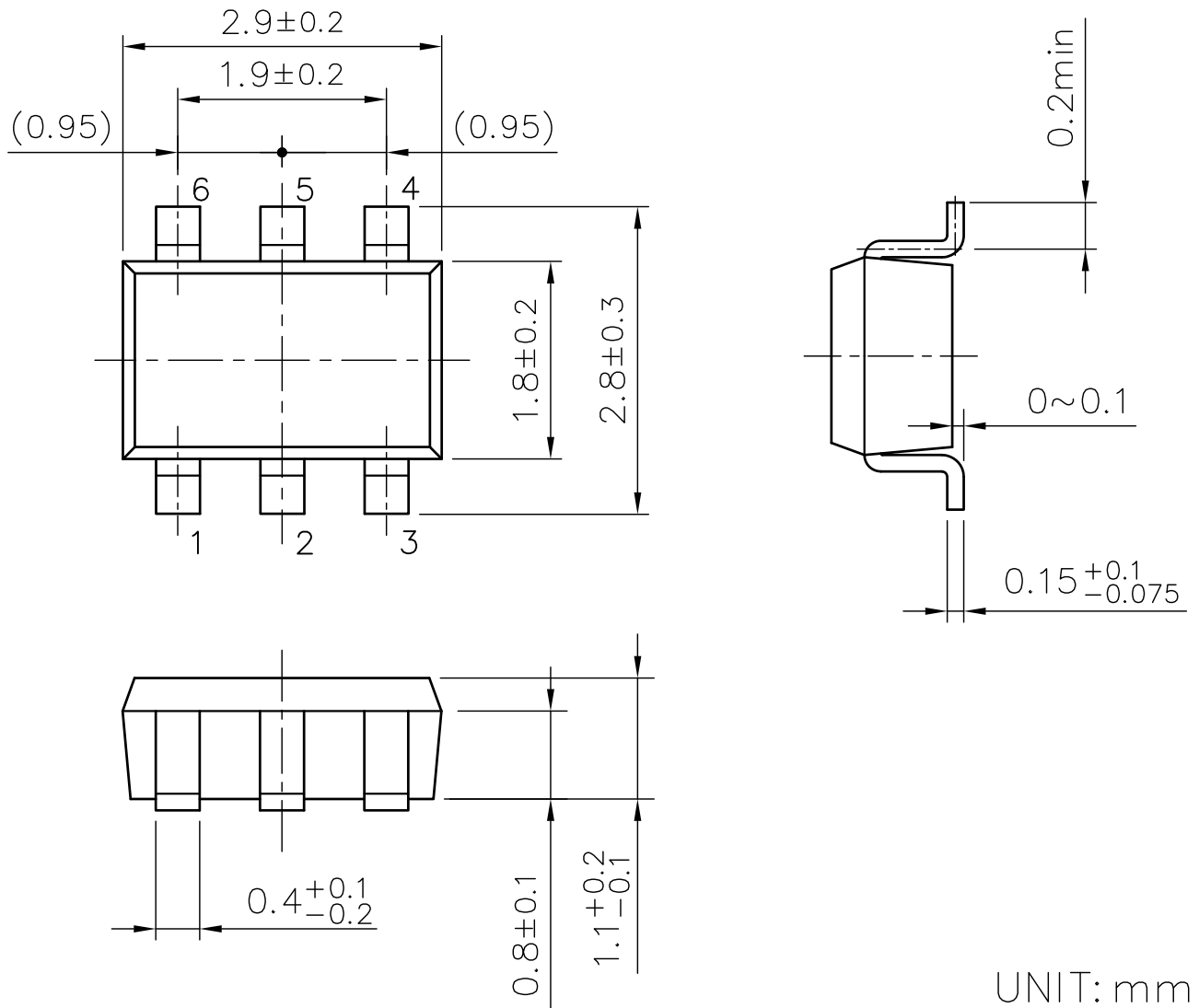

UNIT: mm

SOT-23-6W Package Dimensions (Unit: mm)

The power dissipation of the package is dependent on PCB material, layout, and environmental conditions. The following conditions are used in this measurement.

Measurement Conditions

	High Wattage Land Pattern	Standard Land Pattern
Environment	Mounting on Board (Wind Velocity = 0 m/s)	Mounting on Board (Wind Velocity = 0 m/s)
Board Material	Glass Cloth Epoxy Plastic (Four-Layer Board)	Glass Cloth Epoxy Plastic (Double-Sided Board)
Board Dimensions	35 mm × 90 mm × 0.8 mm	40 mm × 40 mm × 1.6 mm
Copper Ratio	Outer Layers (First and Fourth Layers): Approx. 15% Inner Layers (Second and Third Layers): Approx. 15%	Top Side: Approx. 50% Bottom Side: Approx. 50%
Copper Foil Thickness	Outer Layers (First and Fourth Layers): Approx. 35 μm Inner Layers (Second and Third Layers): Approx. 18 μm	Top Side: Approx. 35 μm Bottom Side: Approx. 35 μm
Through-holes	φ 0.3 mm × 9 holes (connecting outer and inner layers to a package tab) φ 0.5 mm × 10 holes (connecting pins)	φ 0.54 mm × 30 holes

Measurement Result

(Ta = 25°C, Tjmax = 125°C)

	High Wattage Land Pattern	Standard Land Pattern
Power Dissipation	1400 mW (Tjmax = 125°C)	910 mW (Tjmax = 125°C)
Thermal Resistance	$\theta_{ja} = (125 - 25^\circ\text{C}) / 1.4 \text{ W} = 71^\circ\text{C/W}$	$\theta_{jc} = (125 - 25^\circ\text{C}) / 0.91 \text{ W} = 110^\circ\text{C/W}$

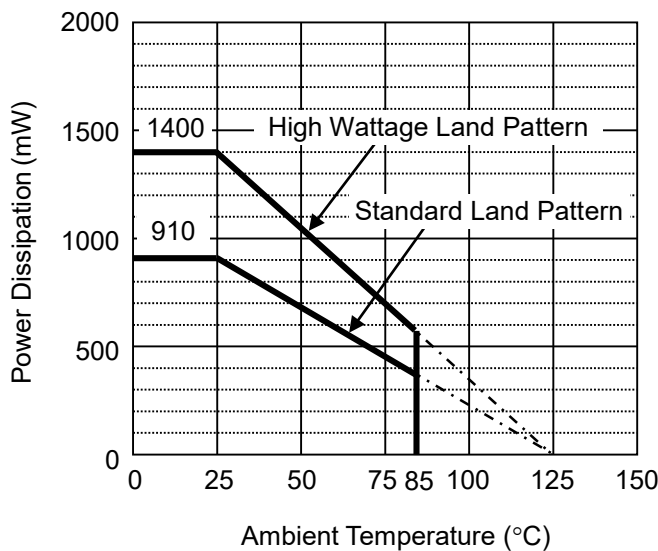

Power Dissipation vs. Ambient Temperature

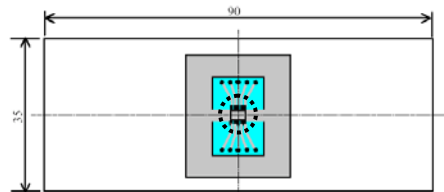

High Wattage

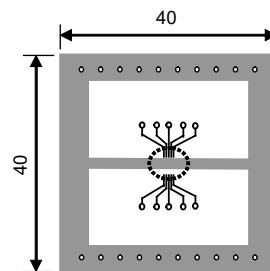

Standard

○ IC Mount Area (mm)

Measurement Board Pattern

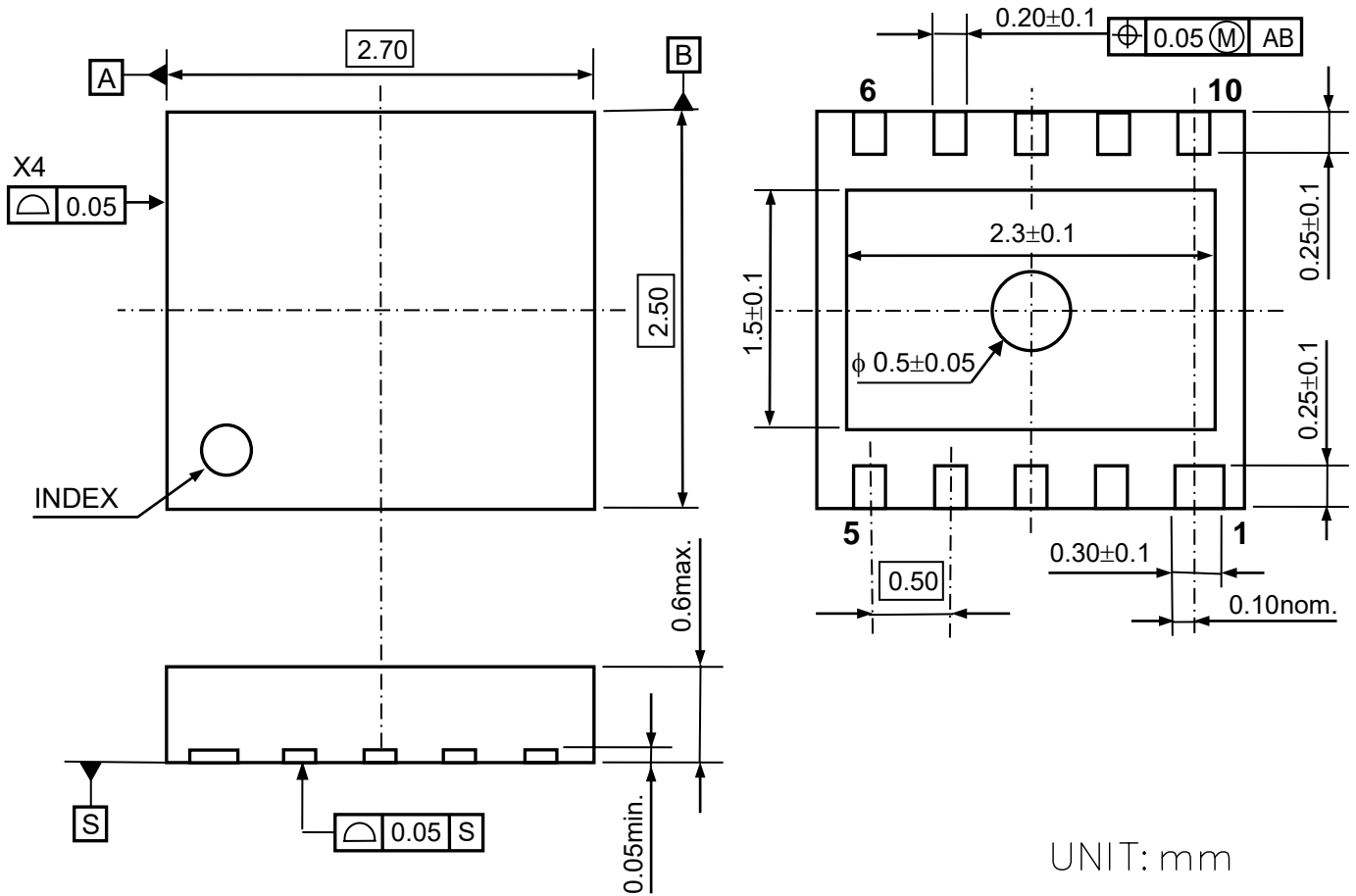

UNIT: mm

DFN(PLP)2527-10 Package Dimensions

* The tab on the bottom of the package is substrate level (GND). It is recommended that the tab be connected to the ground plane on the board, or otherwise be left floating.



1. The products and the product specifications described in this document are subject to change or discontinuation of production without notice for reasons such as improvement. Therefore, before deciding to use the products, please refer to Ricoh sales representatives for the latest information thereon.
2. The materials in this document may not be copied or otherwise reproduced in whole or in part without prior written consent of Ricoh.
3. Please be sure to take any necessary formalities under relevant laws or regulations before exporting or otherwise taking out of your country the products or the technical information described herein.
4. The technical information described in this document shows typical characteristics of and example application circuits for the products. The release of such information is not to be construed as a warranty of or a grant of license under Ricoh's or any third party's intellectual property rights or any other rights.
5. The products listed in this document are intended and designed for use as general electronic components in standard applications (office equipment, telecommunication equipment, measuring instruments, consumer electronic products, amusement equipment etc.). Those customers intending to use a product in an application requiring extreme quality and reliability, for example, in a highly specific application where the failure or misoperation of the product could result in human injury or death (aircraft, spacevehicle, nuclear reactor control system, traffic control system, automotive and transportation equipment, combustion equipment, safety devices, life support system etc.) should first contact us.
6. We are making our continuous effort to improve the quality and reliability of our products, but semiconductor products are likely to fail with certain probability. In order to prevent any injury to persons or damages to property resulting from such failure, customers should be careful enough to incorporate safety measures in their design, such as redundancy feature, fire containment feature and fail-safe feature. We do not assume any liability or responsibility for any loss or damage arising from misuse or inappropriate use of the products.
7. Anti-radiation design is not implemented in the products described in this document.
8. The X-ray exposure can influence functions and characteristics of the products. Confirm the product functions and characteristics in the evaluation stage.
9. WLCSP products should be used in light shielded environments. The light exposure can influence functions and characteristics of the products under operation or storage.
10. There can be variation in the marking when different AOI (Automated Optical Inspection) equipment is used. In the case of recognizing the marking characteristic with AOI, please contact Ricoh sales or our distributor before attempting to use AOI.
11. Please contact Ricoh sales representatives should you have any questions or comments concerning the products or the technical information.



Ricoh is committed to reducing the environmental loading materials in electrical devices with a view to contributing to the protection of human health and the environment.

Ricoh has been providing RoHS compliant products since April 1, 2006 and Halogen-free products since April 1, 2012.

RICOH RICOH ELECTRONIC DEVICES CO., LTD.

<https://www.e-devices.ricoh.co.jp/en/>

Sales & Support Offices

Ricoh Electronic Devices Co., Ltd.

Shin-Yokohama Office (International Sales)

2-3, Shin-Yokohama 3-chome, Kohoku-ku, Yokohama-shi, Kanagawa, 222-8530, Japan
Phone: +81-50-3814-7687 Fax: +81-45-474-0074

Ricoh Americas Holdings, Inc.

675 Campbell Technology Parkway, Suite 200 Campbell, CA 95008, U.S.A.
Phone: +1-408-610-3105

Ricoh Europe (Netherlands) B.V.

Semiconductor Support Centre

Prof. W.H. Keesomlaan 1, 1183 DJ Amstelveen, The Netherlands
Phone: +31-20-5474-309

Ricoh International B.V. - German Branch

Semiconductor Sales and Support Centre

Oberrather Strasse 6, 40472 Düsseldorf, Germany
Phone: +49-211-6546-0

Ricoh Electronic Devices Korea Co., Ltd.

3F, Haesung Bldg, 504, Teheran-ro, Gangnam-gu, Seoul, 135-725, Korea
Phone: +82-2-2135-5700 Fax: +82-2-2051-5713

Ricoh Electronic Devices Shanghai Co., Ltd.

Room 403, No.2 Building, No.690 Bibo Road, Pu Dong New District, Shanghai 201203,
People's Republic of China
Phone: +86-21-5027-3200 Fax: +86-21-5027-3299

Ricoh Electronic Devices Shanghai Co., Ltd.

Shenzhen Branch

1205, Block D (Jinlong Building), Kingkey 100, Hongbao Road, Luohu District,
Shenzhen, China
Phone: +86-755-8348-7600 Ext 225

Ricoh Electronic Devices Co., Ltd.

Taipei office

Room 109, 10F-1, No.51, Hengyang Rd., Taipei City, Taiwan (R.O.C.)
Phone: +886-2-2313-1621/1622 Fax: +886-2-2313-1623

X-ON Electronics

Largest Supplier of Electrical and Electronic Components

Click to view similar products for [Switching Voltage Regulators](#) category:

Click to view products by [Nisshinbo](#) manufacturer:

Other Similar products are found below :

[FAN53610AUC33X](#) [FAN53611AUC123X](#) [FAN48610BUC33X](#) [FAN48610BUC45X](#) [FAN48617UC50X](#) [R3](#) [430464BB](#) [KE177614](#)
[FAN53611AUC12X](#) [MAX809TTR](#) [NCV891234MW50R2G](#) [NCP81103MNTXG](#) [NCP81203PMNTXG](#) [NCP81208MNTXG](#)
[NCP81109GMNTXG](#) [SCY1751FCCT1G](#) [NCP81109JMNTXG](#) [AP3409ADNTR-G1](#) [NCP81241MNTXG](#) [LTM8064IY](#) [LT8315EFE#TRPBF](#)
[LTM4664EY#PBF](#) [LTM4668AIY#PBF](#) [NCV1077CSTBT3G](#) [XCL207A123CR-G](#) [MPM54304GMN-0002](#) [MPM54304GMN-0004](#)
[MPM54304GMN-0003](#) [AP62300Z6-7](#) [MP8757GL-P](#) [MIC23356YFT-TR](#) [LD8116CGL](#) [HG2269M/TR](#) [OB2269](#) [XD3526](#) [U6215A](#) [U6215B](#)
[U6620S](#) [LTC3412IFE](#) [LT1425IS](#) [MAX25203BATJA/VY+](#) [MAX77874CEWM+](#) [XC9236D08CER-G](#) [MP3416GJ-P](#) [MP5461GC-Z](#)
[MPQ4590GS-Z](#) [MAX38640BENT18+T](#) [MAX77511AEWB+](#) [MAX20406AFOD/VY+](#) [MAX20408AFOC/VY+](#)