

PWM/ VFM, Dual-channel Step-up/ Inverting DC/DC Converter with Synchronous Rectifier for LCD

NO.EA-325-180907

OUTLINE

The R1287x is a PWM/ VFM dual-channel step-up/ inverting DC/DC converter with synchronous rectifier for LCD. The step-up DC/DC converter (CH1) generates a 4.5 V to 5.8 V boosted output voltage and the inverting DC/DC converter (CH2) generates a -4.5 V to -6.0 V inverting output voltage.

Internally, the R1287x consists of an oscillator circuit, PWM control circuits, a reference voltage unit, error amplifiers, soft-start circuits, a L_x peak current limit circuit, short protection circuits, thermal shutdown circuit, an under voltage lockout circuit (UVLO), a NMOS transistor driver and a synchronous PMOS transistor driver for CH1, and a PMOS transistor driver and a synchronous NMOS transistor driver for CH2.

The R1287x is employing synchronous rectification for improving the efficiency of rectification by replacing diodes with built-in switching transistors. Using synchronous rectification not only increases circuit performance but also allows a design to reduce parts count.

The R1287x provides the PWM control or the PWM/VFM auto switching control. The PWM control switches at fixed frequency rate in low output current in order to reduce noise. Likewise, the PWM/VFM auto switching control automatically switches from PWM mode to VFM mode in low output current in order to achieve high efficiency. RICOH's unique control method can suppress a ripple voltage in the VFM mode, thus the R1287x can achieve both low ripple voltage at light load and high efficiency.

Both CH1 and CH2 can independently control the ON/ OFF control and freely set the starting sequence and shutdown sequence. Both CH1 and CH2 own an auto-discharge function which actively discharges the output voltage to ground when the device is placed in shutdown mode.

The R1287x is offered in a 12-pin WLCSP-12-P1 package and a 12-pin DFN3030-12 package.

FEATURES

- Operating Voltage Range 2.5 V to 5.5 V

[Step-up DC/DC Converter (CH1)]

- Selectable Step-up Output Voltage (V_{OUTP}) R1287xxxxy: 4.5 V to 5.8 V (0.1 V Step)
- Step-up Output Voltage (Externally adjustable) R1287x001y: 4.5 V to 5.8 V
- Maximum Output Current (Dependent on inductance) R1287xxxxB/D/F/H: 200 mA,
R1287xxxxC/G: 100 mA

[Inverting DC/DC Converter (CH2)]

- Selectable Inverting Output Voltage (V_{OUTN}) R1287xxxxy: -4.5 V to -5.8 V (0.1 V Step)
- Inverting Output Voltage (externally adjustable) R1287x001y: -4.5 V to -6.0 V
- Maximum Output Current (dependent on inductance) R1287xxxxB/D/F/H: 200 mA,
R1287xxxxC/G: 100 mA

R1287x

NO.EA-325-180907

[Controller]

- ON/ OFF Control: Operates CH1/ CH2 separately by the EN1/ EN2 pin.
- Auto-discharge Function: Discharges the output voltage to GND within a short time in shutdown mode.
- Latch-type Short Circuit Protection: Short-circuiting of either one of CH1 or CH2 activates this circuit.
- Maximum Duty Cycle
- L_x Peak Current Limit Function
- Undervoltage Lockout (UVLO) Threshold Typ. 2.25 V
- Thermal Shutdown Temperature Typ. 150°C
- Oscillator Frequency R1287xxxxB/D/F/H: 1 MHz,
R1287xxxxC/G: 300 kHz
- Package WLCSP-12-P1, DFN3030-12

APPLICATIONS

- Power source for hand-held equipment
- Power source for LCD

SELECTION GUIDE

The output voltage types are user-selectable options that can be selected from either fixed output voltage type or adjustable output voltage type. With the fixed output voltage type, the combination of a CH1 output voltage and a CH2 output voltage can be selected. The combination of an oscillator frequency, a power controlling method, and a discharge current can also be selected.

Selection Guide

Product Name	Package	Quantity per Reel	Pb Free	Halogen Free
R1287Zxxxxy-E2-F	WLCSP-12-P1	4,000 pcs	Yes	Yes
R1287Lxxxxy-TR	DFN3030-12	3,000 pcs	Yes	Yes

xxx: Specify the set output voltage (V_{SET}).

001: Adjustable Output Voltage Type, The output voltage is adjustable using external resistors.

002 to 009: Fixed Output Voltage Type

CH1 Output Voltage (V_{OUTP}): selectable from +4.5 V to +5.8 V by 0.1 V step ⁽¹⁾

CH2 Output Voltage (V_{OUTN}): selectable from -4.5 V to -5.8 V by 0.1 V step ⁽¹⁾

Notes: Refer to *Output Voltage for All Combinations of V_{OUTP} and V_{OUTN}* .

y: Specify the oscillator frequency, the power controlling method, and the discharge current.

(B) 1 MHz, PWM/ VFM Auto Switching Control, discharge current 0.06 mA

(C) 300 kHz, PWM Control, discharge current 0.06 mA

(D) 1 MHz, PWM Control, discharge current 0.06 mA

(F) 1 MHz, PWM/ VFM Auto Switching Control, discharge current 0.4 mA ⁽²⁾

(G) 300 kHz, PWM Control, discharge current 0.4 mA ⁽²⁾

(H) 1 MHz, PWM Control, discharge current 0.4 mA ⁽³⁾

Output Voltage for All Combinations of V_{OUTP} and V_{OUTN}

V_{SET} Code No. (xxx)	CH1 Output Voltage (V_{OUTP})	CH2 Output Voltage (V_{OUTN})
001	Adjustable using external resistors	Adjustable using external resistors
002	5.0	-5.0
003	5.4	-5.4
004	5.75	-5.75
005	5.6	-5.6
006	4.5	-4.5
007	5.8	-5.8
008	5.5	-5.5
009 ⁽⁴⁾	5.1	-5.1

⁽¹⁾ 0.05 V step is also available as a custom code

⁽²⁾ F/G versions are only available for R1287Z

⁽³⁾ H version is only available for R1287Z and R1287L002H, R1287L003H, R1287L007H

⁽⁴⁾ V_{SET} Code No.009 is only available for R1287Z

BLOCK DIAGRAMS

R1287xxxxxy Block Diagram (Fixed Output Voltage Type)

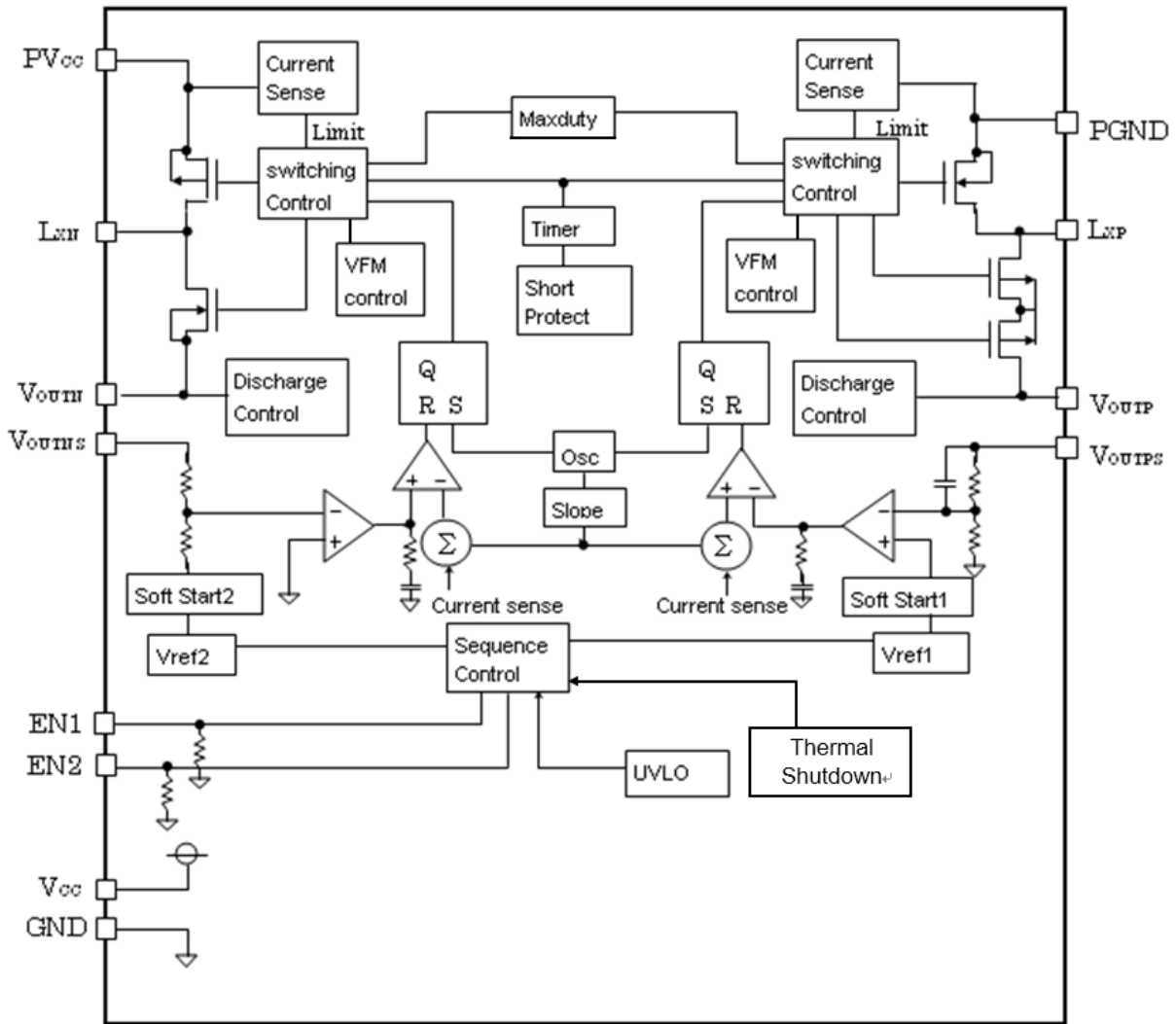

R1287x001y Block Diagram (Adjustable Output Voltage Type)

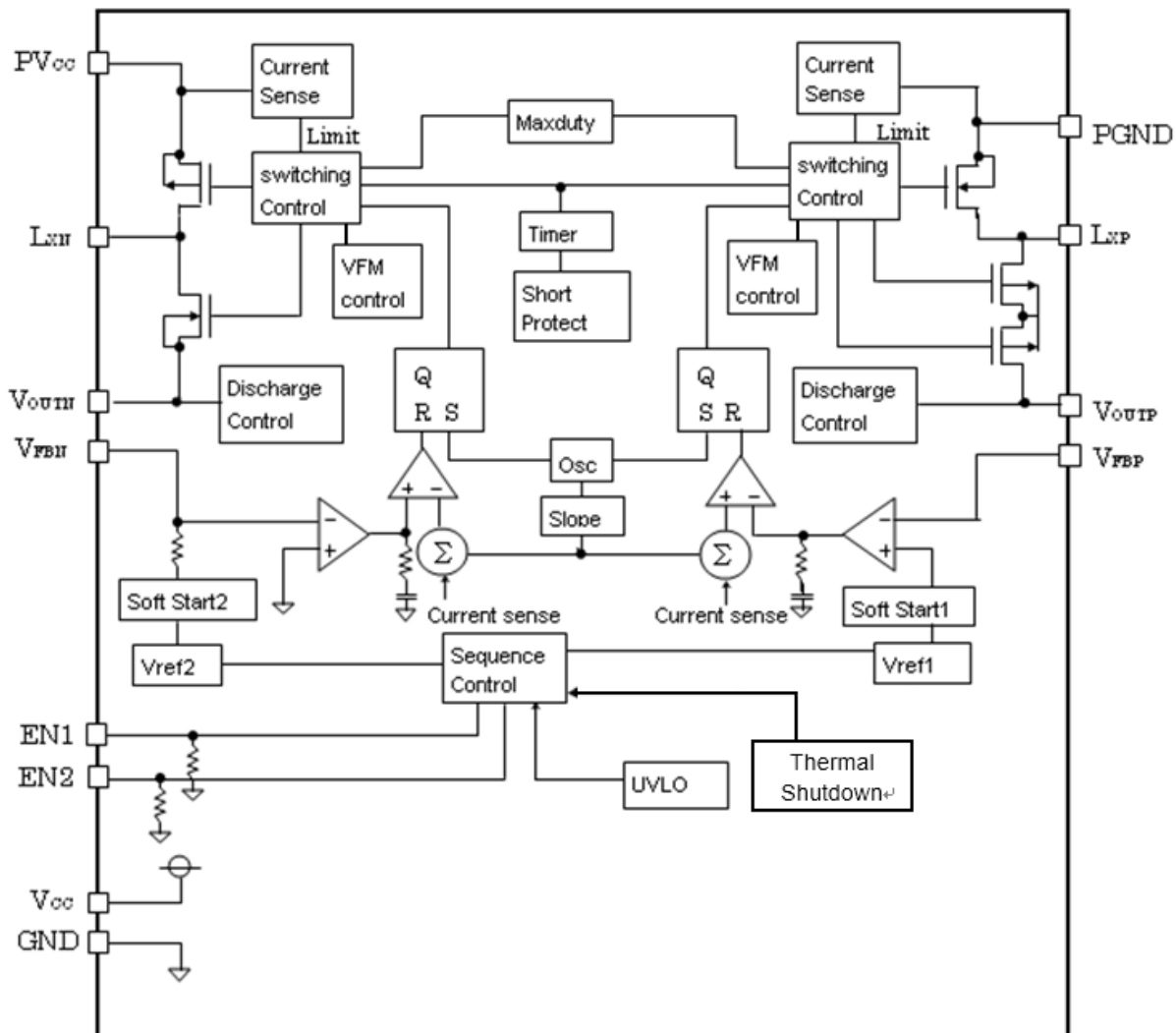

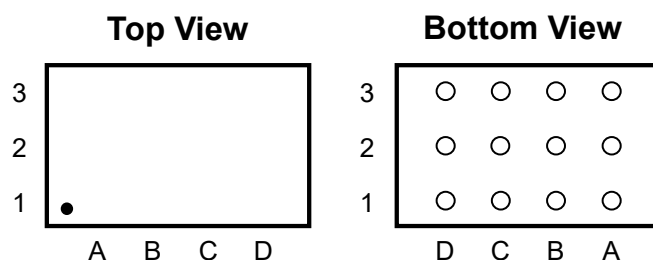
PIN DESCRIPTIONS**WLCSP-12-P1 Pin Configurations****WLCSP-12-P1 Pin Description**

Pin No.	Symbol		Description
A1	V _{OUTN}		CH2 Output Voltage Pin
A2	PGND		Power Ground Pin
A3	L _{XP}		CH1 Switching Output Pin
B1	L _{XN}		CH2 Switching Output Pin
B2	GND		Analog Ground Pin
B3	V _{OUTP}		CH1 Output Voltage Pin
C1	PV _{CC}		Power Input Voltage Pin
C2	V _{CC}		Analog Power Input Voltage Pin
C3	V _{OUTPS}	R1287Z _{xxxy}	CH1 Feedback Voltage Pin
	V _{FBP}	R1287Z001y	
D1	V _{OUTNS}	R1287Z _{xxxy}	CH2 Feedback Voltage Pin
	V _{FBN}	R1287Z001y	
D2	EN2		CH2 Enable Control Pin
D3	EN1		CH1 Enable Control Pin

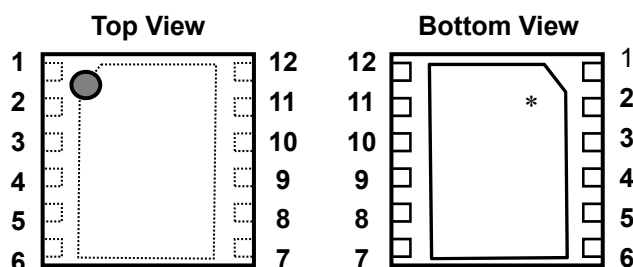

DFN3030-12 Pin Configuration

DFN3030-12 Pin Description

Pin No.	Symbol		Description
1	EN2		CH2 Enable Control Pin
2	V_{OUTNS}	R1287Lxxxxy	CH2 Feedback Voltage Pin
	V_{FBN}	R1287L001y	
3	V_{CC}		Analog Power Input Voltage Pin
4	PV_{CC}		Power Input Voltage Pin
5	L_{XN}		CH2 Switching Output Pin
6	V_{OUTN}		CH2 Output Voltage Pin
7	PGND		Power Ground Pin
8	L_{XP}		CH1 Switching Output Pin
9	V_{OUTP}		CH1 Output Voltage Pin
10	V_{OUTPS}	R1287Lxxxxy	CH1 Feedback Voltage Pin
	V_{FBP}	R1287L001y	
11	GND		Analog Ground Pin
12	EN1		CH1 Enable Control Pin

* The tab on the bottom of the package enhances thermal performance and is electrically connected to GND (substrate level). It is recommended that the tab be connected to the ground plane on the board, or otherwise be left floating.

R1287x

NO.EA-325-180907

ABSOLUTE MAXIMUM RATINGS

Absolute Maximum Ratings

(GND = PGND = 0 V)

Symbol	Item		Rating	Unit
V_{CC}	V_{CC} / PV_{CC} Pin Voltage		-0.3 to 6.0	V
V_{EN}	EN1/ EN2 Pin Voltage		-0.3 to 6.0	V
V_{LXP}	LXP Pin Voltage		-0.3 to 6.5	V
V_{OUTP}	V_{OUTP} Pin Voltage		-0.3 to 6.5	V
V_{LXN}	LXN Pin Voltage		$V_{CC} - 14$ to $V_{CC} + 0.3$	V
V_{OUTN}	V_{OUTN} Pin Voltage		$V_{CC} - 14$ to 0.3	V
V_{OUTPS}	V_{OUTPS} Pin Voltage	R1287xxxxy	-0.3 ~ 6.5	V
V_{OUTNS}	V_{OUTNS} Pin Voltage	R1287xxxxy	$V_{CC} - 14$ ~ $V_{CC} + 0.3$	V
V_{FBP}	V_{FBP} Pin Voltage	R1287x001y	-0.3 to $V_{CC} + 0.3$	V
V_{FBN}	V_{FBN} Pin Voltage	R1287x001y	-0.3 to $V_{CC} + 0.3$	V
P_D	Power Dissipation ⁽¹⁾	(WLCSP-12-P1, Standard Test Land Pattern)	1000	mW
		(DFN3030-12, JEDEC STD.51-7 Test Land Pattern)	3400	
T_j	Junction Temperature Range		-40 to 125	°C
T_{stg}	Storage Temperature Range		-55 to 125	°C

ABSOLUTE MAXIMUM RATINGS

Electronic and mechanical stress momentarily exceeded absolute maximum ratings may cause the permanent damages and may degrade the lifetime and safety for both device and system using the device in the field. The functional operation at or over these absolute maximum ratings is not assured.

RECOMMENDED OPERATING CONDITIONS

Recommended Operating Conditions

Symbol	Parameter	Rating	Unit
V_{CC}	Operating Input Voltage	2.5 to 5.5	V
T_a	Operating Temperature Range	-40 to 85	°C

RECOMMENDED OPERATING CONDITIONS

All of electronic equipment should be designed that the mounted semiconductor devices operate within the recommended operating conditions. The semiconductor devices cannot operate normally over the recommended operating conditions, even if when they are used over such conditions by momentary electronic noise or surge. And the semiconductor devices may receive serious damage when they continue to operate over the recommended operating conditions.

⁽¹⁾ Refer to *POWER DISSIPATION* for detailed information.

ELECTRICAL CHARACTERISTICS

The specifications surrounded by are guaranteed by design engineering at $-40^{\circ}\text{C} \leq T_a \leq 85^{\circ}\text{C}$.

R1287x Electrical Characteristics

($T_a = 25^{\circ}\text{C}$)

Symbol	Item	Conditions	Min.	Typ.	Max.	Unit
I_{CC}	V_{CC} Consumption Current (at no switching)	$V_{CC} = 5.5\text{ V}$, R1287xxxxxy		470		μA
$I_{STANDBY}$	Standby Current	$V_{CC} = V_{LXP} = 5.5\text{ V}$, $V_{EN} = V_{LXN} = 0\text{ V}$, R1287xxxxxy		0.1	5	μA
V_{UVLO1}	UVLO Detector Threshold	Falling, R1287xxxxxy	2.15	2.25		V
V_{UVLO2}	UVLO Released Voltage	Rising, R1287xxxxxy		$V_{UVLO1} + 0.10$	2.48	V
V_{EN1H}	EN1 "H" Input Voltage	$V_{CC} = 3.7\text{ V}$, R1287xxxxxy	1.2			V
V_{EN1L}	EN1 "L" Input Voltage	$V_{CC} = 3.7\text{ V}$, R1287xxxxxy			0.4	V
R_{EN1}	EN1 Pull-down Resistance	$V_{CC} = 3.7\text{ V}$, R1287xxxxxy		1000		$\text{k}\Omega$
V_{EN2H}	EN2 "H" Input Voltage	$V_{CC} = 3.7\text{ V}$, R1287xxxxxy	1.2			V
V_{EN2L}	EN2 "L" Input Voltage	$V_{CC} = 3.7\text{ V}$, R1287xxxxxy			0.4	V
R_{EN2}	EN2 Pull-down Resistance	$V_{CC} = 3.7\text{ V}$, R1287xxxxxy		1000		$\text{k}\Omega$
t_{PROT}	Protection Delay Time	$V_{CC} = 3.7\text{ V}$, R1287xxxxxy	21	30	39	ms
T_{TSD}	Thermal Shutdown Temperature	$V_{CC} = 3.7\text{ V}$, R1287xxxxxy		150		$^{\circ}\text{C}$
T_{TSR}	Thermal Shutdown Released Temperature	$V_{CC} = 3.7\text{ V}$, R1287xxxxxy		125		$^{\circ}\text{C}$

STEP-UP DC/DC CONVERTER (CH1)

$\Delta V_{OUTP} / \Delta I_{OUT}$	V_{OUTP} Load Regulation	$3.2\text{ V} \leq V_{CC} \leq 4.2\text{ V}$, $10\text{ mA} \leq I_{OUT} \leq 100\text{ mA}$, R1287xxxxB/F			± 0.3		%
		$3.2\text{ V} \leq V_{CC} \leq 4.2\text{ V}$, $10\text{ mA} \leq I_{OUT} \leq 100\text{ mA}$, R1287xxxxC/D/G/H			± 0.2		%
f_{OSCP}	CH1 PWM Oscillator Frequency	$V_{CC} = 3.7\text{ V}$	R1287xxxxB/F	700	900	1100	kHz
			R1287xxxxC/G	240	300	360	kHz
			R1287xxxxD/H	800	1000	1200	kHz
Maxduty1	CH1 Maximum Duty Cycle	$V_{CC} = 3.7\text{ V}$	R1287xxxxB/D/F/H		90		%
			R1287xxxxC/G		97		%
I_{VOUTP}	V_{OUTP} Discharge Current	$V_{CC} = 3.7\text{ V}$, $V_{OUTP} = 0.1\text{ V}$	R1287xxxxB/C/D		0.06		mA
			R1287xxxxF/G/H		0.4		mA
t_{SSP}	CH1 Soft-start Time	$V_{CC} = 3.7\text{ V}$, EN1 = "H" to $V_{OUTP} = V_{SET}$	R1287xxxxB/F	1.91		5.54	ms
			R1287xxxxC/G		4.5		ms
			R1287xxxxD/H		4.5		ms

R1287x

NO.EA-325-180907

ELECTRICAL CHARACTERISTICS (continued)

The specifications surrounded by are guaranteed by design engineering at $-40^{\circ}\text{C} \leq T_a \leq 85^{\circ}\text{C}$.

R1287x Electrical Characteristics

($T_a = 25^{\circ}\text{C}$)

Symbol	Item	Conditions	Min.	Typ.	Max.	Unit
t_{RP}	CH1 Rising Time	$V_{CC} = 3.7\text{ V}$, $V_{OUTP} = V_{SET} \times 10\%$ to 90%, R1287xxxxB/F	1.53		4.99	ms
R_{LXP}	CH1 Nch Tr. ON Resistance	$V_{CC} = 3.7\text{ V}$, R1287xxxxy		400		m Ω
R_{SYNCP}	CH1 Pch Tr. ON Resistance	$V_{CC} = 3.7\text{ V}$, R1287xxxxy		700		m Ω
I_{LIMLXP}	CH1 Nch Tr. Current Limit	$V_{CC} = 3.7\text{ V}$, R1287xxxxy		1.1		A
V_{UVP}	V_{OUTP} Low Voltage Detector Threshold	$V_{CC} = 3.7\text{ V}$, R1287xxxxy		2.7		V
[R1287xxxxB, R1287xxxxC, R1287xxxxD, R1287xxxxF, R1287xxxxG, R1287xxxxH]						
V_{OUTP}	V_{OUTP} Voltage	$V_{CC} = 3.7\text{ V}$	$\times 0.991$	V_{SET}	$\times 1.009$	V
$V_{OUTP}/\Delta T_a$	V_{OUTP} Voltage Temperature Coefficient	$V_{CC} = 3.7\text{ V}$, $-40^{\circ}\text{C} \leq T_a \leq 85^{\circ}\text{C}$		± 50		ppm/ $^{\circ}\text{C}$
[R1287x001B, R1287x001C, R1287x001D, R1287x001F, R1287x001G, R1287x001H]						
V_{FBP}	V_{FBP} Voltage	$V_{CC} = 3.7\text{ V}$	0.985	1.000	1.015	V
I_{FBP}	V_{FBP} Input Current	$V_{CC} = 5.5\text{ V}$, $V_{FBP} = 0\text{ V}$ or 5.5 V	-0.1		0.1	μA
$\Delta V_{FBP}/\Delta T_a$	V_{FBP} Voltage Temperature Coefficient	$V_{CC} = 3.7\text{ V}$, $-40^{\circ}\text{C} \leq T_a \leq 85^{\circ}\text{C}$		± 50		ppm/ $^{\circ}\text{C}$

All test items listed under *ELECTRICAL CHARACTERISTICS* are done under the pulse load condition ($T_j \approx T_a = 25^{\circ}\text{C}$) except V_{OUTP} Voltage Temperature Coefficient, V_{FBP} Voltage Temperature Coefficient, V_{OUTP} Load Regulation, CH1 Rising Time, CH1 Nch Tr. ON Resistance and CH1 Pch Tr. ON Resistance.

INVERTING DC/DC CONVERTER (CH2)

$\Delta V_{OUTN}/\Delta I_{OUT}$	V_{OUTN} Load Regulation		$3.2\text{ V} \leq V_{CC} \leq 4.2\text{ V}$, $10\text{ mA} \leq I_{OUT} \leq 100\text{ mA}$, R1287xxxxB/F		± 0.4		%
			$3.2\text{ V} \leq V_{CC} \leq 4.2\text{ V}$, $10\text{ mA} \leq I_{OUT} \leq 100\text{ mA}$, R1287xxxxC/D/G/H		± 0.2		%
f_{oscN}	CH2 PWM Oscillator Frequency	$V_{CC} = 3.7\text{ V}$	R1287xxxxB/F	900	1100	1300	kHz
			R1287xxxxC/G	240	300	360	kHz
			R1287xxxxD/H	800	1000	1200	kHz
Maxduty2	CH2 Maximum Duty Cycle	$V_{CC} = 3.7\text{ V}$	R1287xxxxB/D/F/H		90		%
			R1287xxxxC/G		97		%
I_{VOUTN}	V_{OUTN} Discharge Current	$V_{CC} = 3.7\text{ V}$, $V_{OUTN} = -0.1$	R1287xxxxB/C/D		0.2		mA
			R1287xxxxF/G/H		0.4		mA

ELECTRICAL CHARACTERISTICS (continued)

The specifications surrounded by are guaranteed by design engineering at $-40^{\circ}\text{C} \leq T_a \leq 85^{\circ}\text{C}$.

R1287x Electrical Characteristics

(Ta = 25°C)

Symbol	Item	Conditions	Min.	Typ.	Max.	Unit	
tssn	CH2 Soft-start Time	V _{CC} = 3.7V, EN2 = "H" to V _{OUTN} = V _{SET}	R1287xxxxB/F	0.73		4.11	ms
			R1287xxxxC/G		2.6		ms
			R1287xxxxD/H		2.6		ms
trn	CH2 Rising Time	V _{CC} = 3.7 V, V _{OUTN} = V _{SET} × 10% to 90%, R1287xxxxB/F	0.58		3.29	ms	
R _{LXN}	CH2 Pch Tr. ON Resistance	V _{CC} = 3.7 V, R1287xxxxy		400		mΩ	
R _{SYNCH}	CH2 Nch Tr. ON Resistance	V _{CC} = 3.7 V, R1287xxxxy		600		mΩ	
I _{LIMLXN}	CH2 Pch Tr. Current Limit	V _{CC} = 3.7 V, R1287xxxxy		1.5		A	

[R1287xxxxB, R1287xxxxC, R1287xxxxD, R1287xxxxF, R1287xxxxG, R1287xxxxH]

V _{OUTN}	V _{OUTN} Voltage	V _{CC} = 3.7 V	×0.990	V _{SET}	$\times \frac{1.0}{1}$	V
$\frac{\Delta V_{OUTN}}{\Delta T_a}$	V _{OUTN} Voltage Temperature Coefficient	V _{CC} = 3.7 V, $-40^{\circ}\text{C} \leq T_a \leq 85^{\circ}\text{C}$		±50		ppm/°C

[R1287x001B, R1287x001C, R1287x001D, R1287x001F, R1287x001G, R1287x001H]

V _{FBNO}	V _{FBN} Voltage	V _{CC} = 3.7 V	-30	0	30	mV
I _{FBN}	V _{FBN} Input Current	V _{CC} = 3.7 V, V _{FBN} = V _{FBNO} × 1.2	6.541	6.667	6.794	μA
$\frac{\Delta I_{FBN}}{\Delta T_a}$	I _{FBN} Current Temperature Coefficient	V _{CC} = 3.7 V, $-40^{\circ}\text{C} \leq T_a \leq 85^{\circ}\text{C}$		±150		ppm/°C

All test items listed under *ELECTRICAL CHARACTERISTICS* are done under the pulse load condition (T_j ≈ T_a = 25°C) except V_{OUTN} Load Regulation, CH2 Rising Time, CH2 Pch Tr. ON Resistance, CH2 Nch Tr. ON Resistance, V_{OUTN} Voltage Temperature Coefficient and I_{FBN} Current Temperature Coefficient.

R1287x

NO.EA-325-180907

ELECTRICAL CHARACTERISTICS (continued)**CH1 Electrical Characteristics by Different Output Voltage**

Product Name	$\Delta V_{OUTP}/\Delta I_{OUT}$ [%]	foscP [kHz]			Maxduty1 [%]	V _{OUT} [V]		
	Typ.	Min.	Typ.	Max.	Typ.	Min.	Typ.	Max.
R1287x001B/F	±0.3	700	900	1100	90	-	-	-
R1287x001C/G	±0.2	240	300	360	97			
R1287x001D/H		800	1000	1200	90			
R1287x002B/F	±0.3	700	900	1100	90	4.955	5.0	5.045
R1287x002C/G	±0.2	240	300	360	97			
R1287x002D/H		800	1000	1200	90			
R1287x003B/F	±0.3	700	900	1100	90	5.351	5.4	5.449
R1287x003C/G	±0.2	240	300	360	97			
R1287x003D/H		800	1000	1200	90			
R1287x004B/F	±0.3	700	900	1100	90	5.698	5.75	5.802
R1287x004C/G	±0.2	240	300	360	97			
R1287x004D/H		800	1000	1200	90			
R1287x005B/F	±0.3	700	900	1100	90	5.550	5.6	5.650
R1287x005C/G	±0.2	240	300	360	97			
R1287x005D/H		800	1000	1200	90			
R1287x006B/F	±0.3	700	900	1100	90	4.460	4.5	4.541
R1287x006C/G	±0.2	240	300	360	97			
R1287x006D/H		800	1000	1200	90			
R1287x007B/F	±0.3	700	900	1100	90	5.748	5.8	5.852
R1287x007C/G	±0.2	240	300	360	97			
R1287x007D/H		800	1000	1200	90			
R1287x008B/F	±0.3	700	900	1100	90	5.451	5.5	5.550
R1287x008C/G	±0.2	240	300	360	97			
R1287x008D/H		800	1000	1200	90			
R1287x009B/F	±0.3	700	900	1100	90	5.054	5.1	5.146
R1287x009C/G	±0.2	240	300	360	97			
R1287x009D/H		800	1000	1200	90			

ELECTRICAL CHARACTERISTICS (continued)**CH2 Electrical Characteristics by Different Output Voltage**

Product Name	$\Delta V_{OUTN}/\Delta I_{OUT}$	foscN			Maxduty2	V _{OUT}		
	[%]	[kHz]			[%]	[V]		
	Typ.	Min.	Typ.	Max.	Typ.	Min.	Typ.	Max.
R1287x001B/F	±0.4	900	1100	1200	90	-	-	-
R1287x001C/G	±0.2	240	300	360	97			
R1287x001D/H		800	1000	1200	90			
R1287x002B/F	±0.4	900	1100	1200	90	-4.950	-5.0	-5.050
R1287x002C/G	±0.2	240	300	360	97			
R1287x002D/H		800	1000	1200	90			
R1287x003B/F	±0.4	900	1100	1200	90	-5.346	-5.4	-5.454
R1287x003C/G	±0.2	240	300	360	97			
R1287x003D/H		800	1000	1200	90			
R1287x004B/F	±0.4	900	1100	1200	90	-5.693	-5.75	-5.808
R1287x004C/G	±0.2	240	300	360	97			
R1287x004D/H		800	1000	1200	90			
R1287x005B/F	±0.4	900	1100	1200	90	-5.544	-5.6	-5.656
R1287x005C/G	±0.2	240	300	360	97			
R1287x005D/H		800	1000	1200	90			
R1287x006B/F	±0.4	900	1100	1200	90	-4.455	-4.5	-4.545
R1287x006C/G	±0.2	240	300	360	97			
R1287x006D/H		800	1000	1200	90			
R1287x007B/F	±0.4	900	1100	1200	90	-5.742	-5.8	-5.858
R1287x007C/G	±0.2	240	300	360	97			
R1287x007D/H		800	1000	1200	90			
R1287x008B/F	±0.4	900	1100	1200	90	-5.445	-5.5	-5.555
R1287x008C/G	±0.2	240	300	360	97			
R1287x008D/H		800	1000	1200	90			
R1287x009B/F	±0.4	900	1100	1200	90	-5.049	-5.1	-5.151
R1287x009C/G	±0.2	240	300	360	97			
R1287x009D/H		800	1000	1200	90			

THEORY OF OPERATION

EN1 / EN2 Enabled Timing

When enabled the EN1 pin first and then the EN2 pin

If the EN1 pin is switched from low to high, CH1 performs soft-start operation. If the EN2 pin is switched from low to high while the EN1 pin is high, CH2 will not perform soft-start operation until CH1 detects that the output voltage of CH1 (V_{OUTP}) has reached the preset voltage.

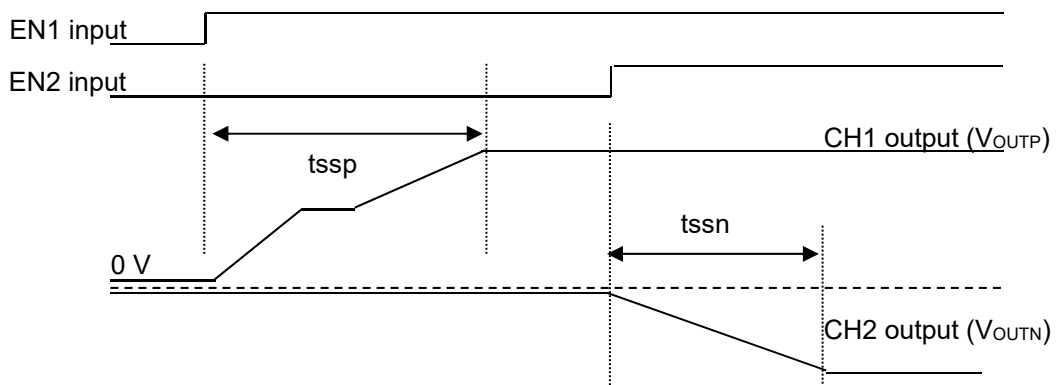

When enabled the EN2 pin first and then the EN1 pin

If the EN2 pin is switched from low to high, CH2 performs soft-start operation. If the EN1 pin is switched from low to high while the EN2 pin is high, CH1 will not perform soft-start operation until CH2 detects that the output voltage of CH2 (V_{OUTN}) has reached the preset voltage.

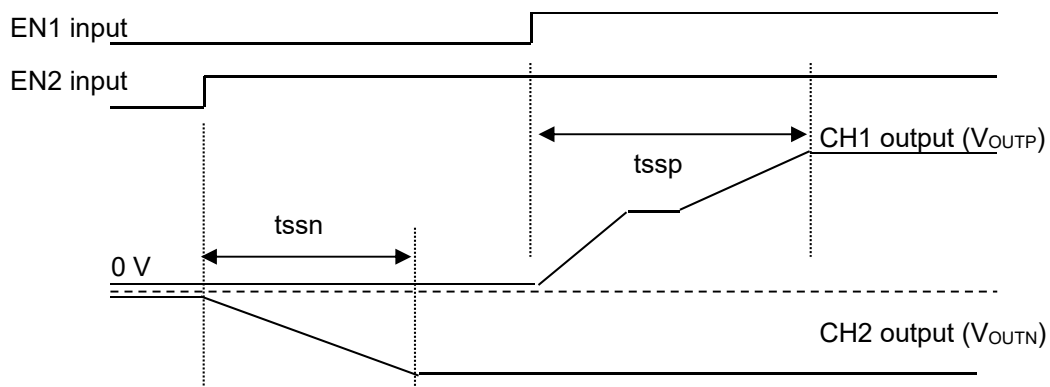

When enabled the EN1 Pin and the EN2 Pin while Short-circuiting

If the EN1 pin and the EN2 pin are switched from low to high while they are short-circuited, CH1 performs soft-start operation. CH2 will not perform soft-start operation until CH1 detects that the output voltage of CH1 (V_{OUTP}) has reached the preset voltage.

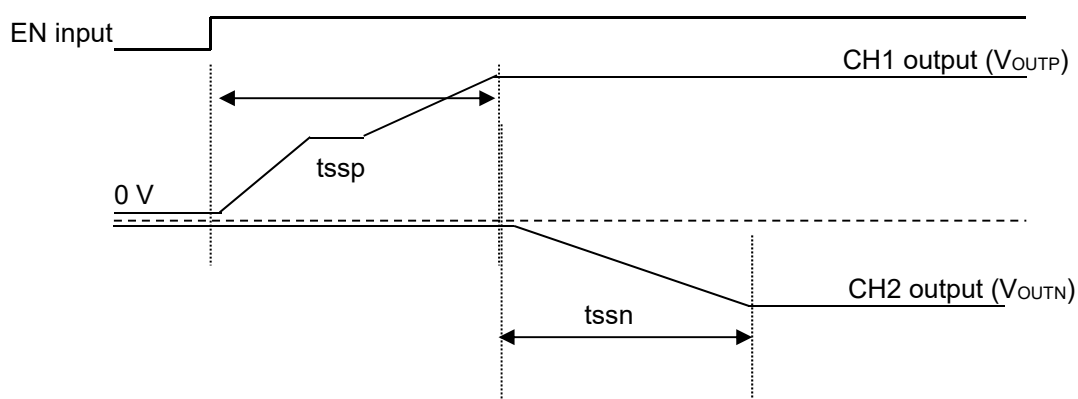

Auto Discharge Function

CH1 can be turned off by setting the EN1 pin low, and CH2 can be turned off by setting the EN2 pin low. Both CH1 and CH2 can be controlled individually. If CH1/ CH2 is turned off by setting the EN1/ EN2 pin low, the auto-discharge function is enabled. The switch between the V_{OUTP}/ V_{OUTN} pin and the GND pin is turned on while the auto-discharge function is enabled. While both EN1 and EN2 pins are set low, the device is in the standby mode. If CH1/ CH2 is turned off by other reasons, such as the V_{CC} pin voltage is dropped below the UVLO detector threshold or the timer-latch circuit is triggered due to short-circuit, the auto-discharge function is disabled.

Example of R1287xxxxB/C/D Falling Waveform

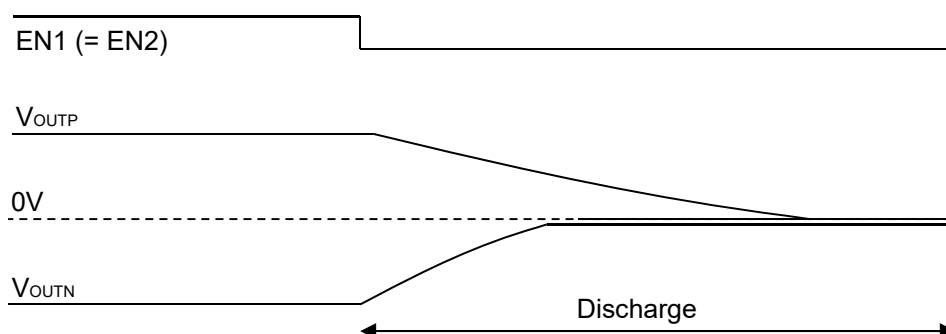

R1287x

NO.EA-325-180907

Example of R1287xxxxF/G/H Falling Waveform

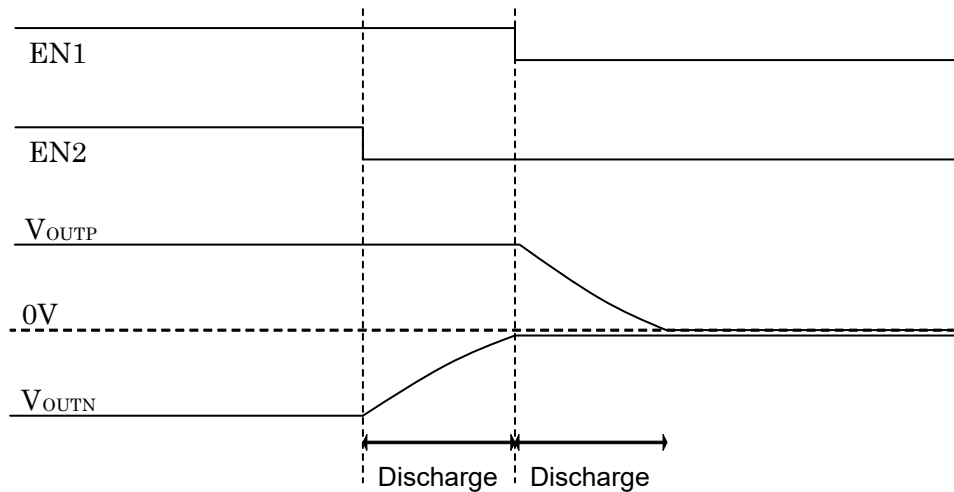

Thermal Shutdown Protection

Thermal shutdown circuit detects the overheating of the device and stops the device operation to protect the device from damages. If the internal temperature of the device exceeds the thermal shutdown temperature, the thermal shutdown circuit turns off the drivers and synchronous transistors. If the internal temperature of the device falls below the thermal shutdown release temperature, the thermal shutdown circuit resets the device and restarts the device operation. Please note that the re-starting sequence of the device is performed by the following order: CH2 first and then CH1.

Low Output Voltage Detection Circuit for CH1

If CH1 detects a significant voltage drop, after the completion of soft-start operation, CH1 resets the device and restarts the device operation. Please note that the re-starting sequence of the device is performed by the following order: CH1 first and then CH2.

L_x Peak Current Limit Timer/ Latch-type Short Circuit Protection Timer

The L_x peak current limit circuit supervises the peak current of the inductor, which is passing through NMOS transistor of CH1 and PMOS transistor of CH2, in every switching cycle. If the peak current exceeds the L_x peak current limit (I_{LIMLXP}/I_{LIMLXN}), the L_x peak current limit circuit turns off the NMOS transistor of CH1 or PMOS transistor of CH2. The latch-type short circuit protection circuit latches the built-in drivers of CH1 and CH2 off to stop the operation of the device if the overcurrent state continues more than the protection delay time (t_{prot}). Please note that I_{LIMLXP}/I_{LIMLXN} and t_{prot} can be easily affected by self-heating and ambient environment. Also, the significant voltage drop or the unstable voltage caused by short-circuiting may affect on the protection operation and the delay time. To release the latch-type short circuit protection, switch the EN1/ EN2 pin from high to low to reset the device or make the input voltage (V_{IN}) lower than the UVLO detector threshold (V_{UVLO1}).

During the softstart operation of CH1 and CH2, both L_x peak current limit circuit timer and latch-type short circuit protection circuit timer operate until CH1 and CH2 reach their preset voltages. Therefore, the normal operation of circuit timers will not be affected by the abnormal completion of soft-start operation due to short-circuit or etc.

Protection Resistors between V_{OUTN} and V_{OUTNS} in Fixed Output Voltage Type (R1287Lxxxx)

If the V_{OUTNS} pin and the V_{OUTN} pin are connected to each other on PCB while the V_{OUTNS} pin and the V_{CC} pin or the EN2 pin are short-circuited due to some failure, the voltage higher than the rated voltage will be applied to the V_{OUTN} pin. To prevent this, it is recommended that an approximately $100\ \Omega$ protection resistor be connected between the V_{OUTN} pin and the V_{OUTNS} pin.

Operation of CH1 and Output Current

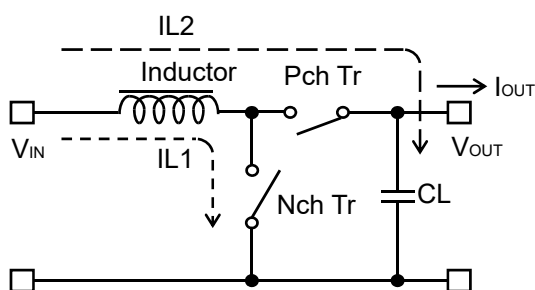

Basic Circuit

Discontinuous Inductor Current Mode

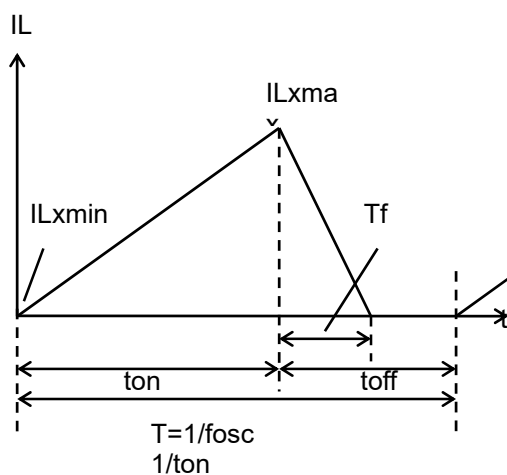

Continuous Inductor Current Mode

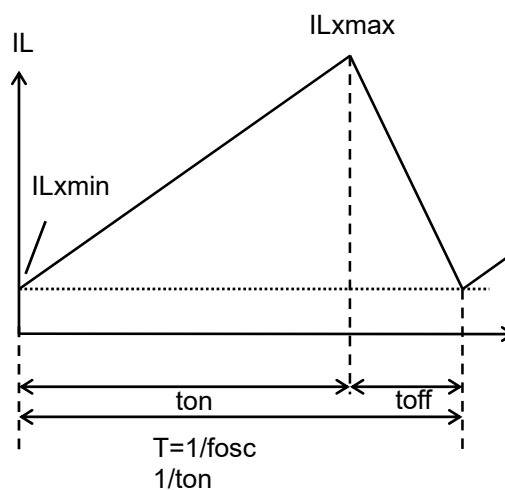

Inductor Current Waveshapes (IL) through Inductor (L)

The PWM control type of CH1 has two operation modes characterized by the continuity of inductor current: discontinuous inductor current mode and continuous inductor current mode.

R1287x

NO.EA-325-180907

When a NMOS Tr. is in On-state, the voltage to be applied to the inductor (L) is described as V_{IN} . An increase in the inductor current (IL1) can be written as follows:

$$IL1 = V_{IN} \times t_{on} / L \dots\dots\dots \text{Equation 1}$$

In the CH1 circuit, the energy accumulated during the On-state is transferred into the capacitor even in the Off-state. A decrease in the inductor current (IL2) can be written as follows:

$$IL2 = (V_{OUT} - V_{IN}) \times t_f / L \dots\dots\dots \text{Equation 2}$$

In the PWM control, IL1 and IL2 become continuous when $t_f = t_{off}$, which is called continuous inductor current mode.

When the device is in continuous inductor current mode and operates in steady-state conditions, the variations of IL1 and IL2 are same:

$$V_{IN} \times t_{on} / L = (V_{OUT} - V_{IN}) \times t_{off} / L \dots\dots\dots \text{Equation 3}$$

Therefore, the duty cycle in continuous inductor current mode is:

$$\text{Duty} = t_{on} / (t_{on} + t_{off}) = (V_{OUT} - V_{IN}) / V_{OUT} \dots\dots\dots \text{Equation 4}$$

If the input voltage (V_{IN}) is equal to V_{OUT} , the output current (I_{OUT}) is:

$$I_{OUT} = V_{IN}^2 \times t_{on} / (2 \times L \times V_{OUT}) \dots\dots\dots \text{Equation 5}$$

If I_{OUT} is larger than Equation 5, the device switches to continuous inductor current mode.

The L_x peak current flowing through L (IL_{xmax}) is:

$$IL_{xmax} = I_{OUT} \times V_{OUT} / V_{IN} + V_{IN} \times t_{on} / (2 \times L) \dots\dots\dots \text{Equation 6}$$

$$IL_{xmax} = I_{OUT} \times V_{OUT} / V_{IN} + V_{IN} \times T \times (V_{OUT} - V_{IN}) / (2 \times L \times V_{OUT}) \dots\dots\dots \text{Equation 7}$$

As a result, IL_{xmax} becomes larger compared to I_{OUT} .

In discontinuous inductor current mode, IL_{xmax} is:

$$IL_{xmax} = \sqrt{(2 \times I_{OUT} \times (V_{OUT} - V_{IN}) \times T / L)} \dots\dots\dots \text{Equation 8}$$

The L_x peak current limit circuit operates in both modes if the IL_{xmax} becomes more than the L_x peak current limit. When considering the input and output conditions or selecting the external components, please pay attention to IL_{xmax} .

Notes: The above calculations are based on the ideal operation of the device. They do not include the losses caused by the external components or L_x switch. The actual maximum output current will be 70% to 90% of the above calculation results. Especially, if IL is large or V_{IN} is low, it may cause the switching losses.

Operation of CH2 and Output Current

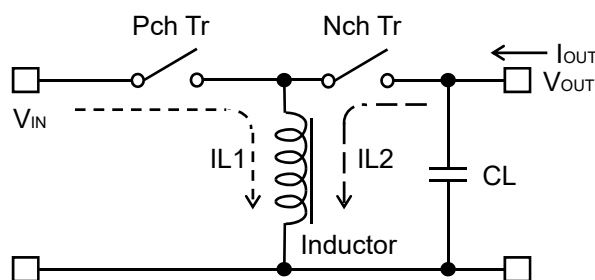

Basic Circuit

Discontinuous Inductor Current Mode

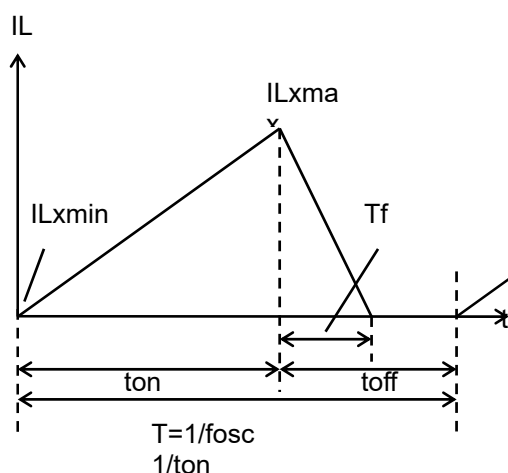

Continuous Inductor Current Mode

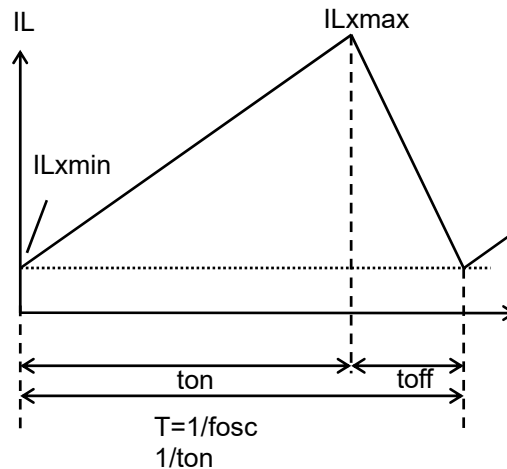

Inductor Current Waveshapes (IL) through Inductor (L)

The PWM control type of CH2 has two operation modes characterized by the continuity of inductor current: discontinuous inductor current mode and continuous inductor current mode.

When a PMOS Tr. is in ON-state, the voltage to be applied to the inductor (L) is described as V_{IN} . An increase in the inductor current ($IL1$) can be written as follows:

$$IL1 = V_{IN} \times ton / L \dots \dots \dots \text{Equation 9}$$

R1287x

NO.EA-325-180907

In the CH2 circuit, the energy accumulated during the On-state is transferred into the capacitor even in the Off-state. A decrease in the inductor current (I_{L2}) can be written as follows:

$$I_{L2} = |V_{OUT}| \times t_f / L \dots\dots\dots \text{Equation 10}$$

In the PWM control type, when $t_f = t_{off}$, the inductor current will be continuous and the operation of CH2 will be continuous inductor current mode. When the device is in continuous inductor current mode and operates in steady-state conditions, the variation of I_{L1} and I_{L2} are same:

$$V_{IN} \times t_{on} / L = |V_{OUT}| \times t_{off} / L \dots\dots\dots \text{Equation 11}$$

Therefore, the duty cycle in continuous inductor current mode is:

$$\text{Duty} = t_{on} / (t_{on} + t_{off}) = |V_{OUT}| / (|V_{OUT}| + V_{IN}) \dots\dots\dots \text{Equation 12}$$

If the input voltage (V_{IN}) equal to V_{OUT} , the output current (I_{OUT}) is:

$$I_{OUT} = V_{IN}^2 \times t_{on} / (2 \times L \times |V_{OUT}|) \dots\dots\dots \text{Equation 13}$$

If I_{OUT} is larger than Equation 13, the device switches to continuous inductor current mode.

The L_x peak current flowing through L (I_{Lxmax}) is:

$$I_{Lxmax} = I_{OUT} \times (|V_{OUT}| + V_{IN}) / V_{IN} + V_{IN} \times t_{on} / (2 \times L) \dots\dots\dots \text{Equation 14}$$

$$I_{Lxmax} = I_{OUT} \times (|V_{OUT}| + V_{IN}) / V_{IN} + V_{IN} \times |V_{OUT}| \times T / \{ 2 \times L \times (|V_{OUT}| + V_{IN}) \} \dots\dots\dots \text{Equation 15}$$

As a result, I_{Lxmax} becomes larger compared to I_{OUT} .

In discontinuous inductor current mode, I_{Lxmax} is:

$$I_{Lxmax} = \sqrt{(2 \times I_{OUT} \times |V_{OUT}| \times T / L)} \dots\dots\dots \text{Equation 16}$$

The L_x peak current limit circuit operates in both modes if the I_{Lxmax} becomes more than the L_x peak current limit. When considering the input and output conditions or selecting the external components, please pay attention to I_{Lxmax} .

Notes: The above calculations are based on the ideal operation of the device. They do not include the losses caused by the external components or L_x switch. The actual maximum output current will be 70% to 90% of the above calculation results. Especially, if I_L is large or V_{IN} is low, it may cause the switching losses.

VFM Mode Operation (R1287xxxxB/F)

The PWM/VFM auto switching control automatically switches from PWM mode to VFM mode in low output current in order to achieve high efficiency. With the VFM mode operation, t_{on} is preset inside the IC.

In continuous inductor current mode, if the inductor current is set to $4.7\ \mu\text{H}$, t_{on} is set in a way that I_{Lmax} becomes 600 mA or less. In discontinuous inductor current mode, if the inductor current is set to $4.7\ \mu\text{H}$, t_{on} is set in a way that I_{Lpp} becomes 400 mA or less.

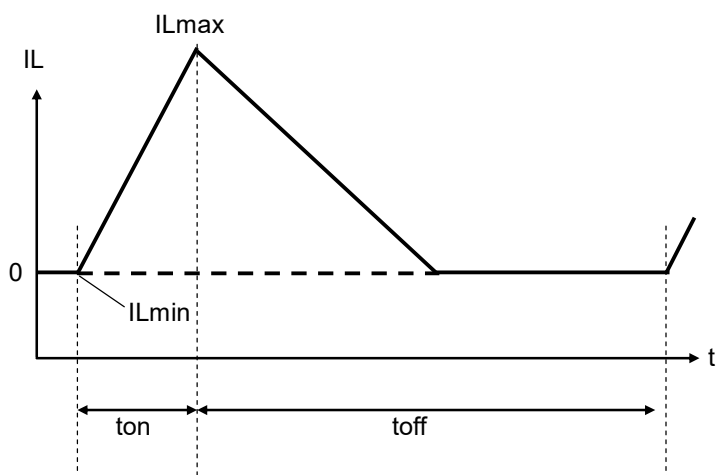

VFM Mode Operation (Discontinuous Inductor Current Mode)

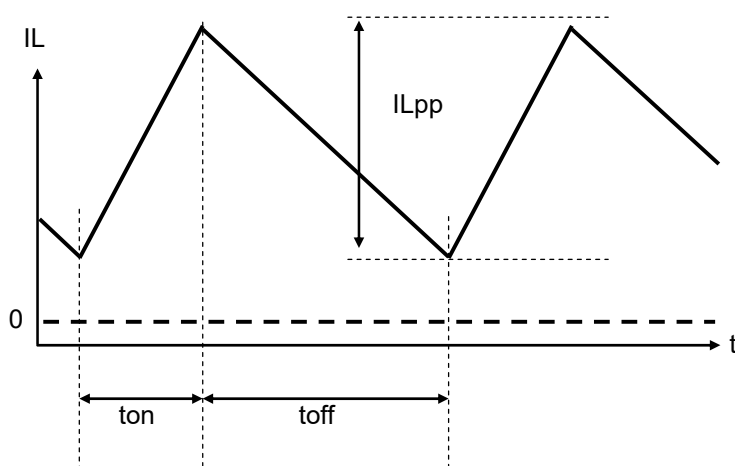

VFM Mode Operation (Continuous Inductor Current Mode)

APPLICATION INFORMATION

Typical Application Circuit

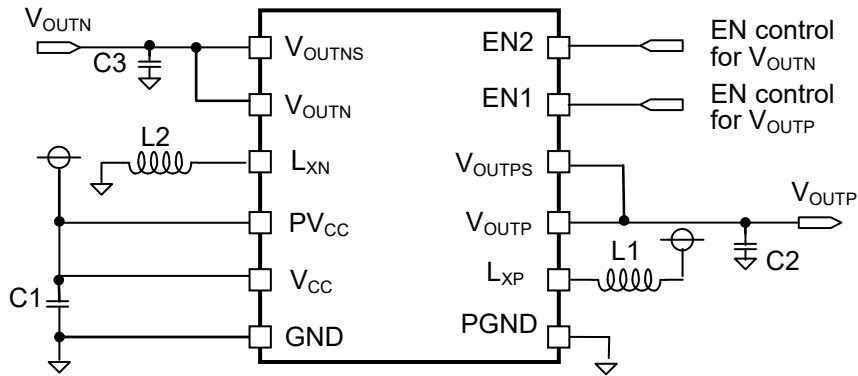

R1287xxxxxy Typical Application (Fixed Output Voltage Type)

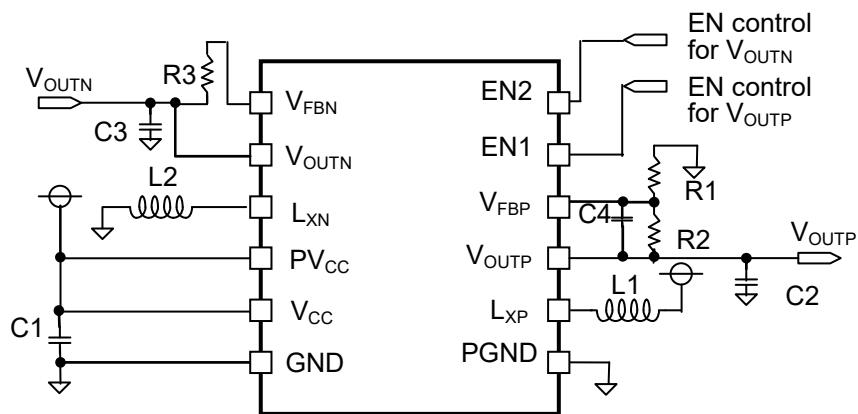

R1287x001y Typical Application (Adjustable Output Voltage Type)

Recommended Components

Symbol	Descriptions
L1, L2	VLF302510M-4R7M, TDK DFE252010C, TOKO, 1269AS-H-4R7M=P2
C1 (C _{IN})	10 μF, 2012 size, X5R T = Max. 0.85, C2012X5R0J106M, TDK
C2 (C _{OUTP})	10 μF, 2012 size, X5R T = Max. 0.85, C2012X5R0J106M, TDK
C3 (C _{OUTN})	10 μF, 2012 size, X5R T = Max. 0.85, C2012X5R0J106M, TDK

TECHNICAL NOTES

The performance of a power source circuit using this device is highly dependent on a peripheral circuit. A peripheral component or the device mounted on PCB should not exceed a rated voltage, a rated current or a rated power. When designing a peripheral circuit, please be fully aware of the following points.

- Place a 10 μ F or more ceramic capacitor (C1) between the V_{CC} pin and the GND pin, or the PV_{CC} pin and the PGND pin in a shortest distance. The GND pin should be connected to the GND plane of the PCB.
- Make GND and PGND to the same potential.
- Make V_{CC} and PV_{CC} to the same potential.
- The wiring between L_{XP} pin, L_{XN} pin and inductor each should be as short as possible and mount output capacitors (C2 and C3) as close as possible to the V_{OUTP} , V_{OUTN} each.
- Input impedance of V_{OUTPS} pin, V_{OUTNS} pin, V_{FBP} pin, and V_{FBN} pin is high, therefore, the external noise may affect on the performance. The coupling capacitance between these nodes and switching lines must be as short as possible.
- For stable operation of the device, the R1287x provides a phase compensation circuit according to the values of inductors (L1, L2) and capacitors (C2, C3).
Use L1 or L2 which is having a low equivalent series resistance, having enough tolerable current and which is less likely to cause magnetic saturation. A large load current causes a significant drop of the inductance value. Therefore, select the inductor value in consideration of the amount of load current under using condition. A significant drop of the inductance value can cause an increase in the L_x peak current along with an increase in the load current. When the L_x peak current reaches the current limit, the L_x peak current limit circuit starts operating.

- **CH1 Output Voltage Setting (R1287x001y: Adjustable Output Voltage Type)**

The output voltage of CH1 (V_{OUTP}) controls the output voltage of CH1 feedback pin voltage (V_{FBP}) to 1.0 V. V_{OUTP} , depending on the resistors (R1 and R2), can be calculated as follows:

$$V_{OUTP} = V_{FBP} \times (R1 + R2) / R1$$

V_{OUTP} can be set within the range of 4.5 V to 5.8 V. R1 between 20 k Ω to 60 k Ω is recommended.

- **CH2 Output Voltage Setting (R1287x001y: Adjustable Output Voltage Type)**

The output voltage of CH2 (V_{OUTN}) controls the output voltage of CH2 feedback pin voltage (V_{FBN}) to 0 V.

V_{OUTN} , depending on the resistor (R3) and the V_{FBN} pin input current (I_{FBN}), can be calculated as follows:

$$V_{OUTN} = -I_{FBN} \times R3$$

V_{OUTN} can be set within the range of -4.5 V to -6.0 V. The recommended value for R3 is as follows:

V_{OUTN} Setting	R3
-5.0 V	750 k Ω
-5.4 V	810 k Ω (310 k Ω + 500 k Ω)
-5.6 V	840 k Ω (680 k Ω + 160 k Ω)

- **Phase Compensation of CH1 (R1287x001y: Adjustable Output Voltage Type)**

The phase compensation of CH1 can be delayed 180 degree because of the external components (L, C) and the load current. The phase delay causes the loss in phase margins and stability. Therefore, the phase advance should be ensured.

A zero-point can be formed with R1 and C4 as follows:

$$C4 \text{ [pF]} = 300 / R1 \text{ [k}\Omega\text{]}$$

- **Protection Resistor between VOUTN and VOUTNS Pins (R1287Lxxxy: Fixed Output Voltage Type)**

If the VOUTNS pin and the VOUTN pin are connected to each other on PCB while the VOUTNS pin and the VCC pin or the EN2 pin are short-circuited due to some failure, the voltage higher than the rated voltage will be applied to the VOUTN pin. To prevent this, it is recommended that an approximately 100 Ω protection resistor (R4) be connected between the VOUTN pin and the VOUTNS pin.

- **Current Path on PCB**

The current paths of boost DC/DC converter are shown in Fig.3 and Fig.4, and the current path of inverting DC/DC converter are shown in Fig.5 and Fig. 6.

The parasitic impedance, inductance, and the capacitance in the parts pointed with red arrows in Fig.4 and Fig.6 have an influence against the stability of the DC/DC converters and become a cause of the noise.

Therefore, such parasitic elements must be made as small as possible.

Wiring of the current paths shown in Fig3 to Fig6 must be short and thick.

【Boost DCDC Converter】

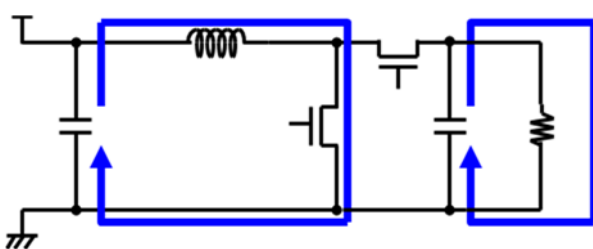

NMOSFET-ON (BOOST)

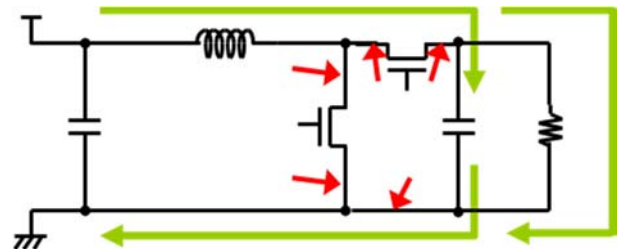

PMOSFET-ON (BOOST)

【Inverting DCDC Converter】

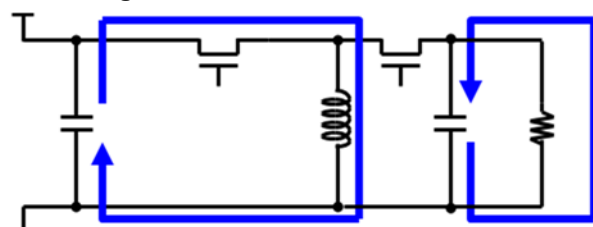

PMOSFET-ON (INVERTING)

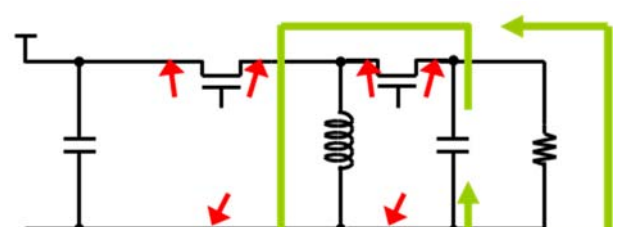

NMOSFET-ON (INVERTING)

PCB Layout

R1287Zxxxy (PKG: WLCSP-12)

Top Side

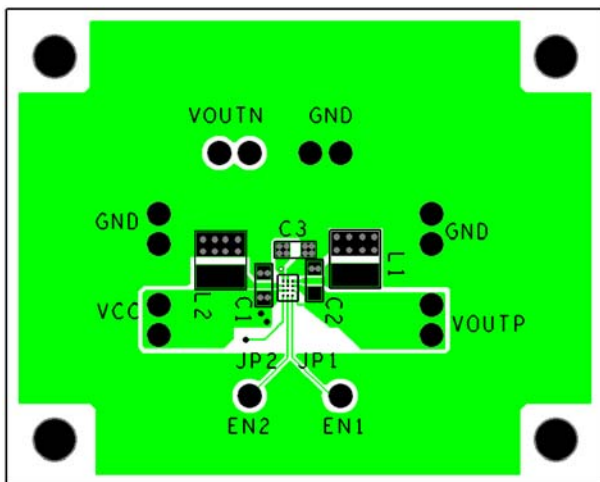

Bottom Side

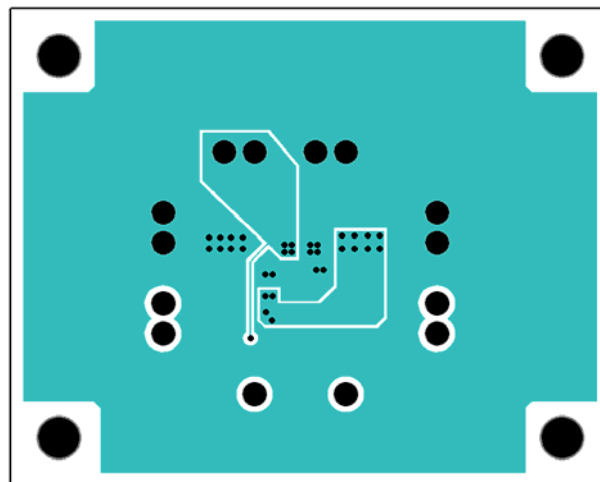

R1287Z001y (PKG: WLCSP-12)

Top Side

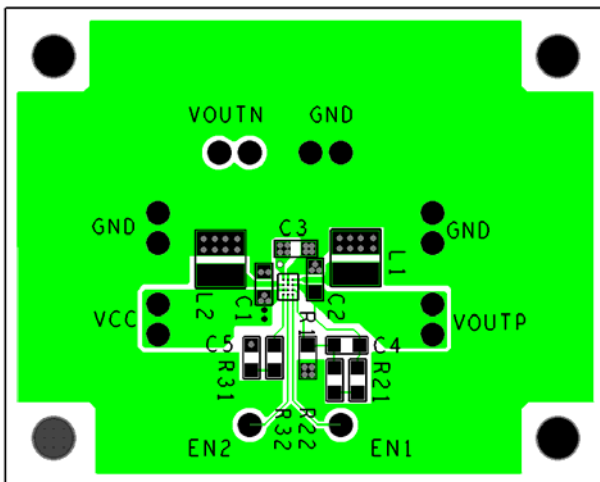

Bottom Side

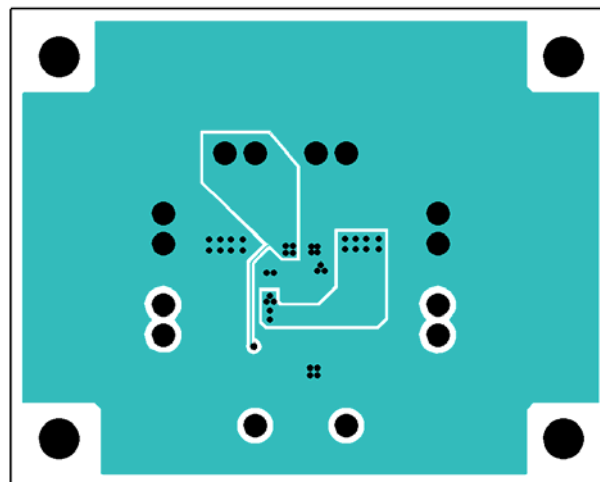

TYPICAL CHARACTERISTICS

Notes: Typical Characteristics are intended to be used as reference data; they are not guaranteed.

1) Output Voltage vs. Output Current

R1287x001B/F ($V_{OUTP} = 5.0\text{ V}$)
($T_a = 25^\circ\text{C}$)

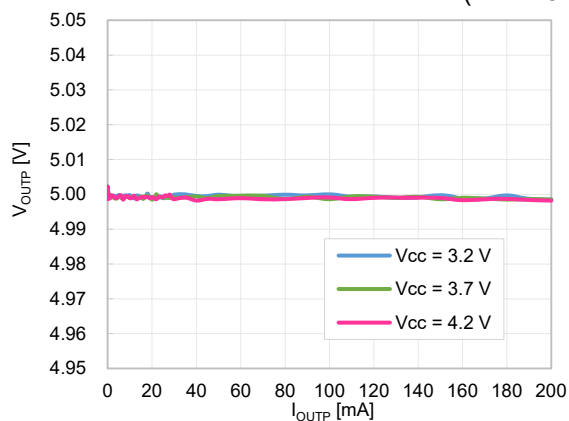

R1287x001C/G ($V_{OUTP} = 5.0\text{ V}$)
($T_a = 25^\circ\text{C}$)

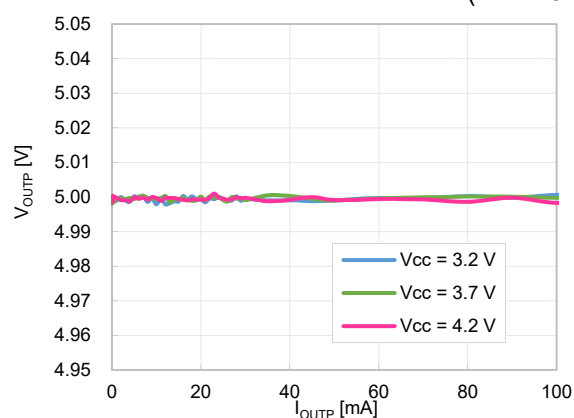

R1287x001D/H ($V_{OUTP} = 5.0\text{ V}$)
($T_a = 25^\circ\text{C}$)

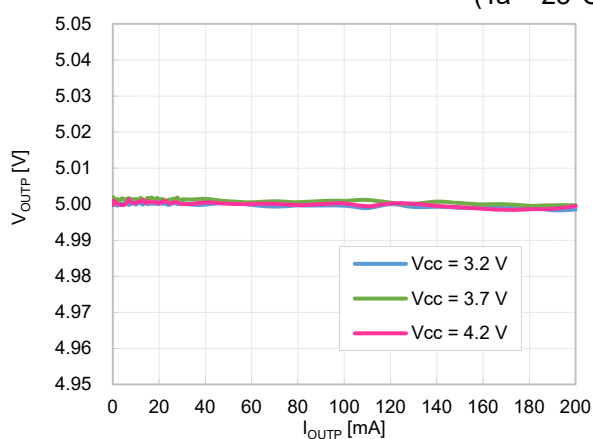

R1287x001B/F ($V_{OUTP} = 5.6\text{ V}$)
($T_a = 25^\circ\text{C}$)

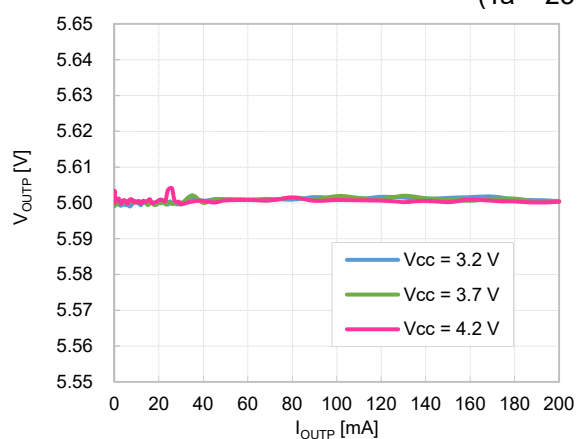

R1287x001C/G ($V_{OUTP} = 5.6\text{ V}$)
($T_a = 25^\circ\text{C}$)

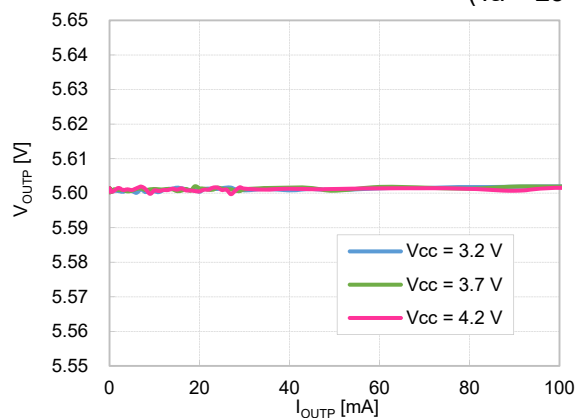

R1287x001B/F ($V_{OUTN} = -5.0\text{ V}$)
($T_a = 25^\circ\text{C}$)

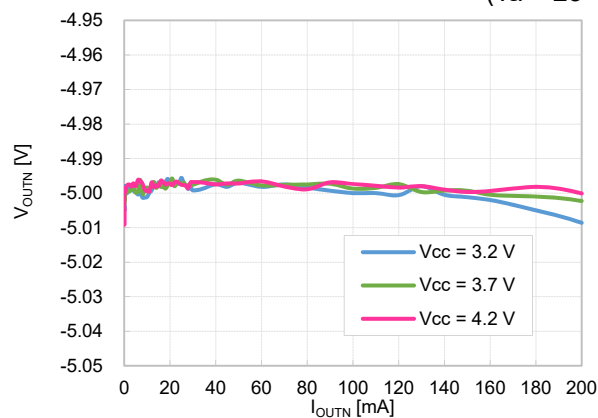

R1287x

NO.EA-325-180907

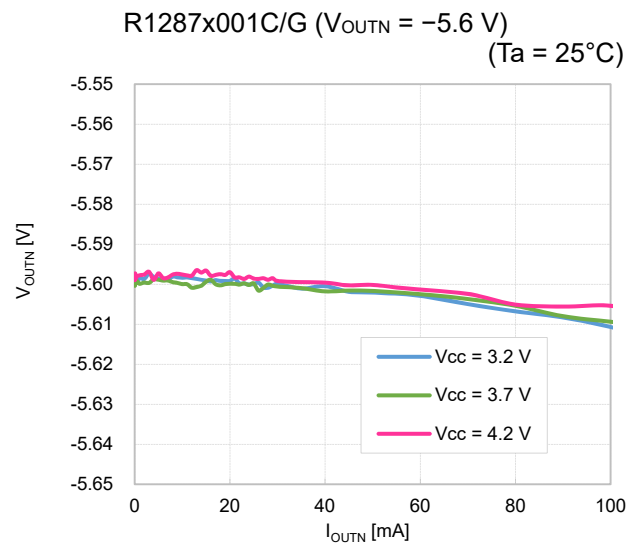
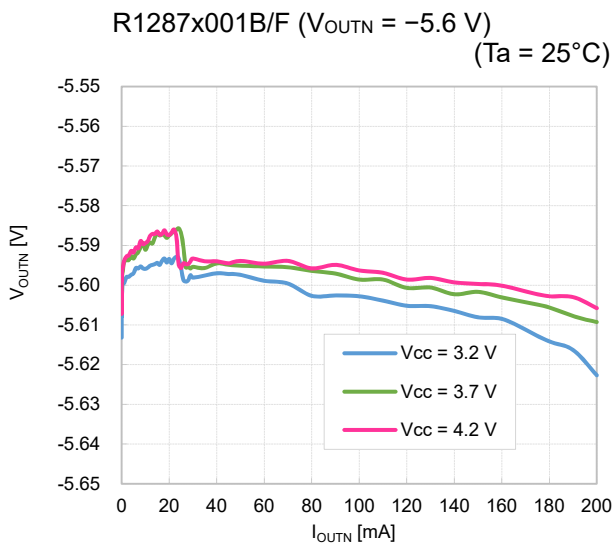
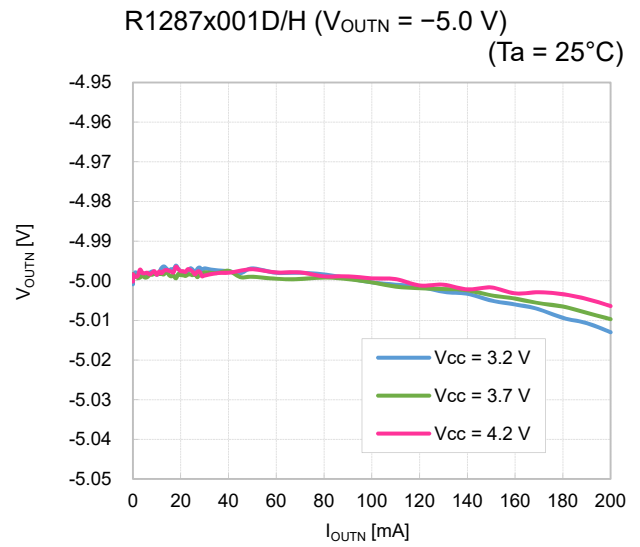
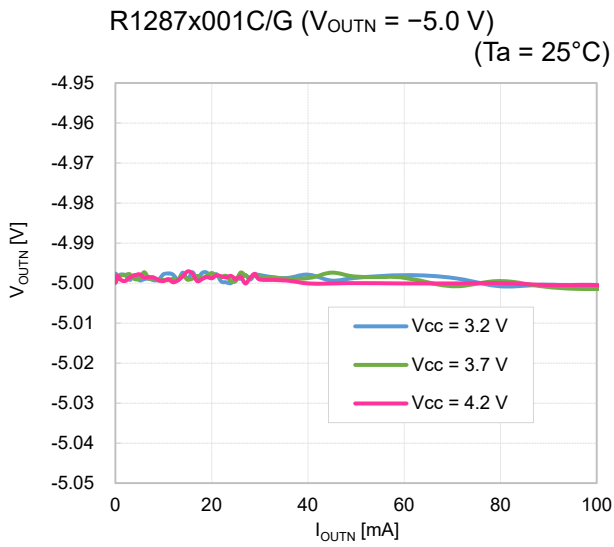

2) Efficiency vs. Output Current

R1287x001B/F ($V_{OUTP} = 5.0\text{ V}$, $V_{OUTN} = -5.0\text{ V}$)
($T_a = 25^\circ\text{C}$)

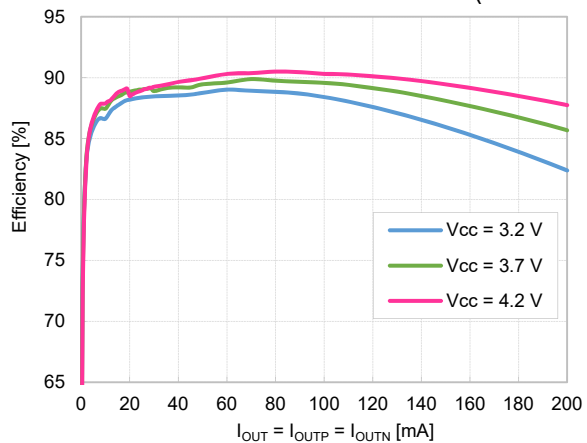

R1287x001C/G ($V_{OUTP} = 5.0\text{ V}$, $V_{OUTN} = -5.0\text{ V}$)
($T_a = 25^\circ\text{C}$)

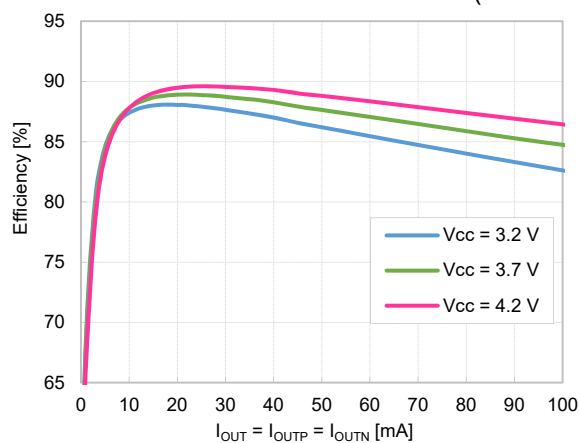

R1287x001D/H ($V_{OUTP} = 5.0\text{ V}$, $V_{OUTN} = -5.0\text{ V}$)
($T_a = 25^\circ\text{C}$)

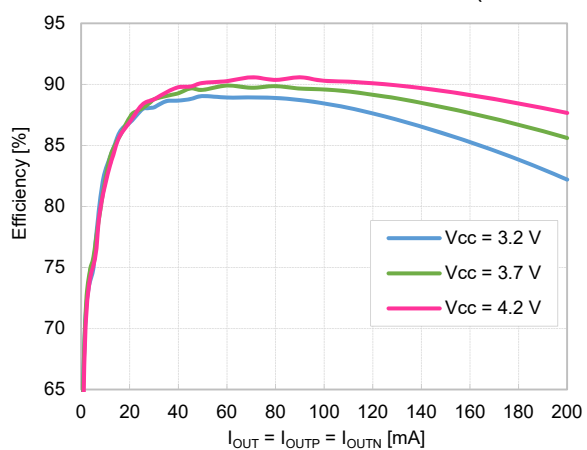

R1287x001B/F ($V_{OUTP} = 5.6\text{ V}$, $V_{OUTN} = -5.6\text{ V}$)
($T_a = 25^\circ\text{C}$)

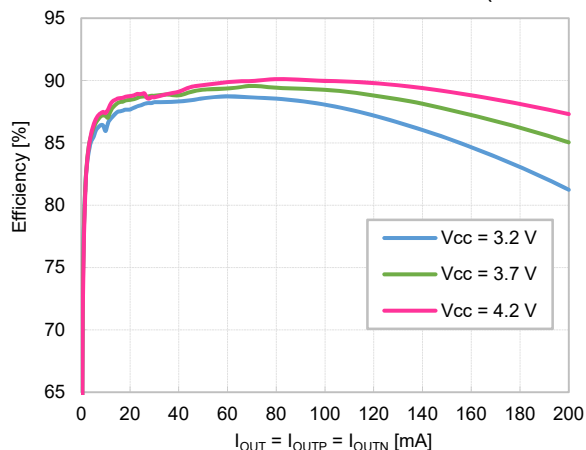

R1287x001C/G ($V_{OUTP} = 5.6\text{ V}$, $V_{OUTN} = -5.6\text{ V}$)
($T_a = 25^\circ\text{C}$)

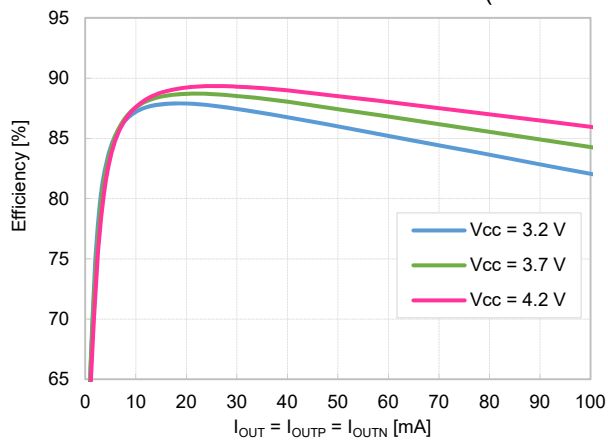

R1287x

NO.EA-325-180907

3) Frequency vs. Output Current (VFM mode)

R1287x001B/F ($V_{OUTP} = 5.0\text{ V}$)
($T_a = 25^\circ\text{C}$)

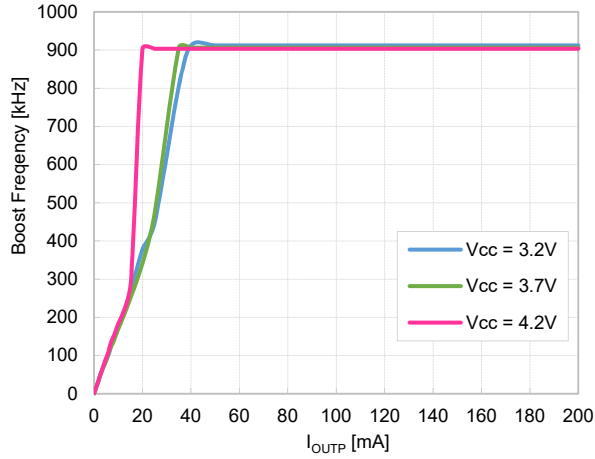

R1287x001B/F ($V_{OUTP} = 5.6\text{ V}$)
($T_a = 25^\circ\text{C}$)

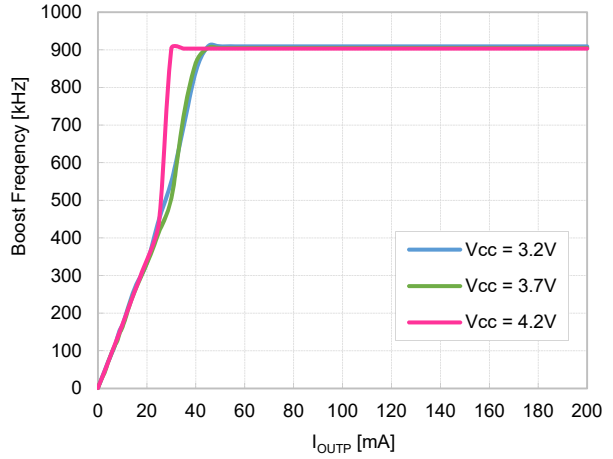

R1287x001B/F ($V_{OUTN} = -5.0\text{ V}$)
($T_a = 25^\circ\text{C}$)

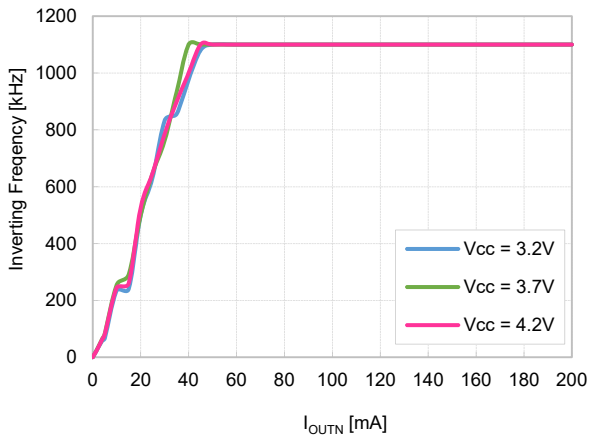

R1287x001B/F ($V_{OUTN} = -5.6\text{ V}$)
($T_a = 25^\circ\text{C}$)

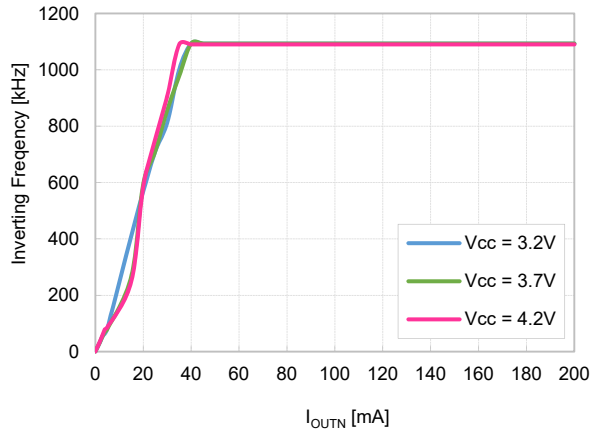

4) Turn-on Waveform by EN1 & EN2

$V_{CC} = PV_{CC} = 3.7\text{ V}$, $I_{OUTP} = I_{OUTN} = 0\text{ mA}$
R1287x001B/F ($V_{OUTP} = 5.0\text{ V}$, $V_{OUTN} = -5.0\text{ V}$)
($T_a = 25^\circ\text{C}$)

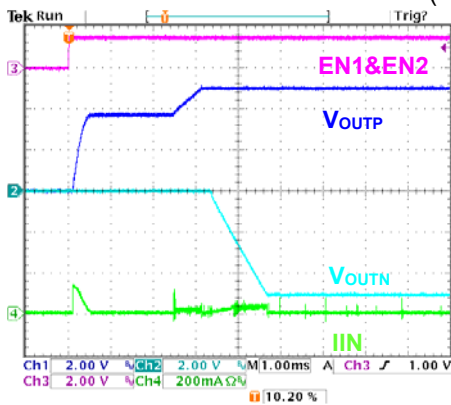

R1287x001C/G ($V_{OUTP} = 5.0\text{ V}$, $V_{OUTN} = -5.0\text{ V}$)
($T_a = 25^\circ\text{C}$)

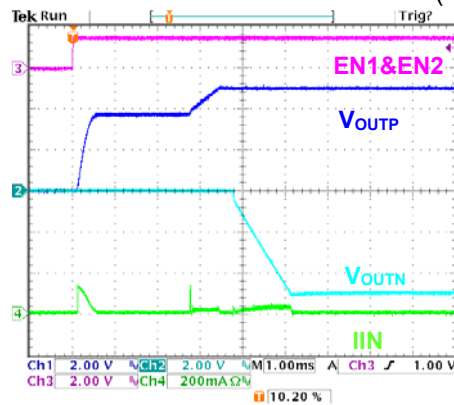

R1287x001D/H ($V_{OUTP} = 5.0\text{ V}$, $V_{OUTN} = -5.0\text{ V}$)
($T_a = 25^\circ\text{C}$)

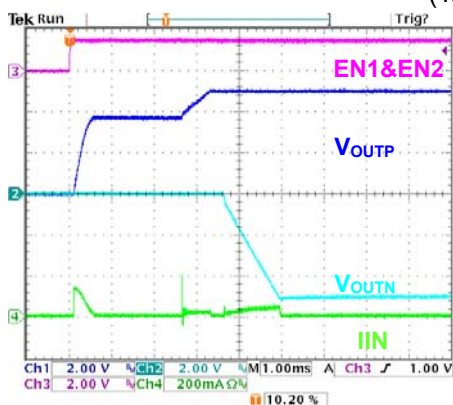

5) Turn-on Waveform by EN1 -> EN2

$V_{CC} = PV_{CC} = 3.7\text{ V}$, $I_{OUTP} = I_{OUTN} = 0\text{ mA}$
R1287x001D/H ($V_{OUTP} = 5.0\text{ V}$, $V_{OUTN} = -5.0\text{ V}$)
($T_a = 25^\circ\text{C}$)

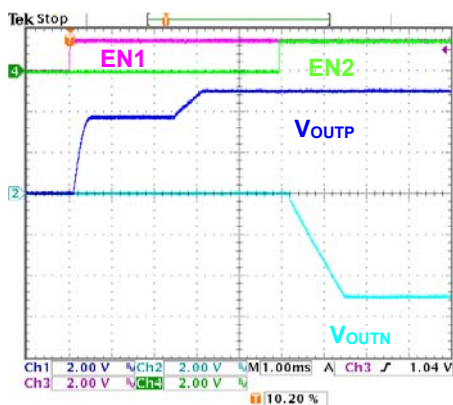

6) Turn-on Waveform by EN2 -> EN1

$V_{CC} = PV_{CC} = 3.7\text{ V}$, $I_{OUTP} = I_{OUTN} = 0\text{ mA}$
R1287x001B/F ($V_{OUTP} = 5.0\text{ V}$, $V_{OUTN} = -5.0\text{ V}$)
($T_a = 25^\circ\text{C}$)

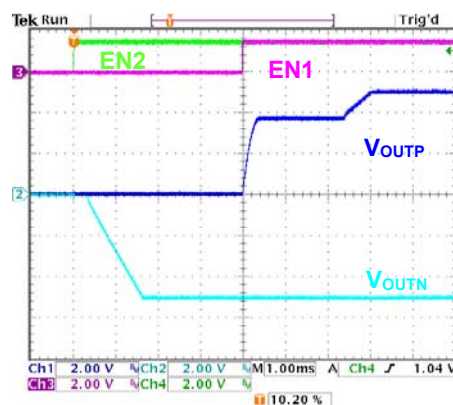

7) Turn-off Waveform by EN1 & EN2

$V_{CC} = PV_{CC} = 3.7\text{ V}$, $I_{OUTP} = I_{OUTN} = 0\text{ mA}$
R1287x001B/C/D ($V_{OUTP} = 5.0\text{ V}$, $V_{OUTN} = -5.0\text{ V}$)
($T_a = 25^\circ\text{C}$)

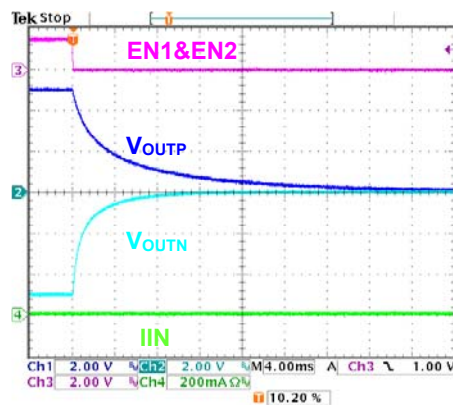

R1287x001F/G/H ($V_{OUTP} = 5.0\text{ V}$, $V_{OUTN} = -5.0\text{ V}$)
($T_a = 25^\circ\text{C}$)

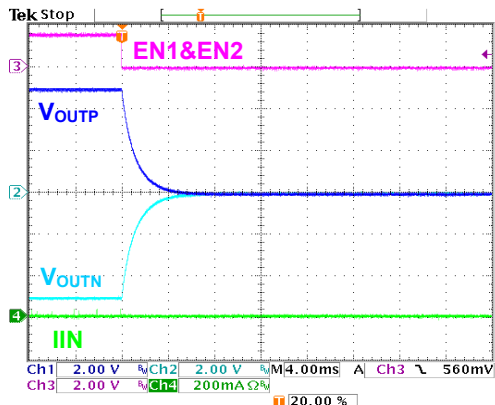

R1287x

NO.EA-325-180907

8) Load Transient Response Waveform

$V_{CC} = PV_{CC} = 3.7\text{ V}$

R1287x001B/F ($V_{OUTP} = 5.0\text{ V}$)
($T_a = 25^\circ\text{C}$)

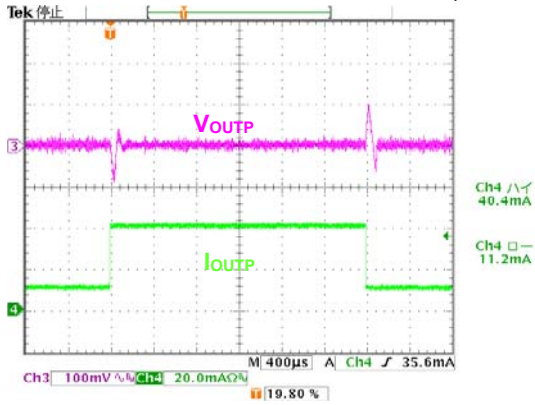

R1287x001B/F ($V_{OUTN} = -5.0\text{ V}$)
($T_a = 25^\circ\text{C}$)

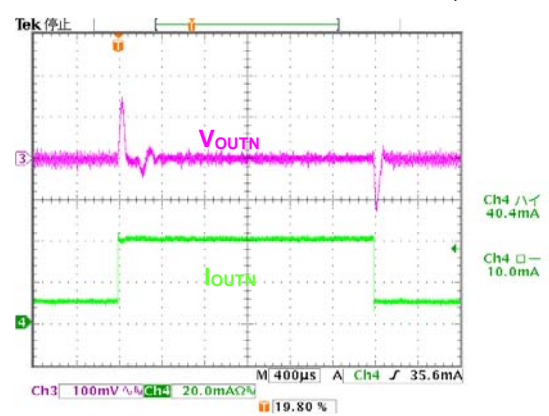

R1287x001C/G ($V_{OUTP} = 5.0\text{ V}$)
($T_a = 25^\circ\text{C}$)

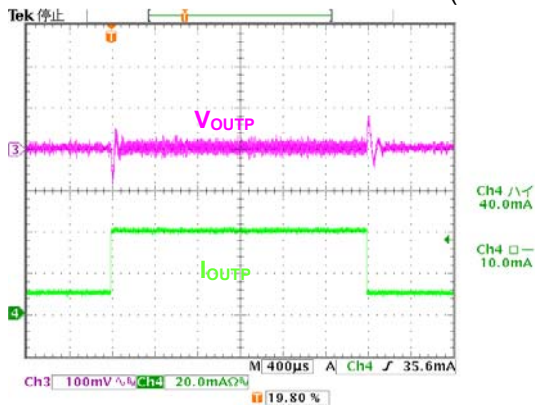

R1287x001C/G ($V_{OUTN} = -5.0\text{ V}$)
($T_a = 25^\circ\text{C}$)

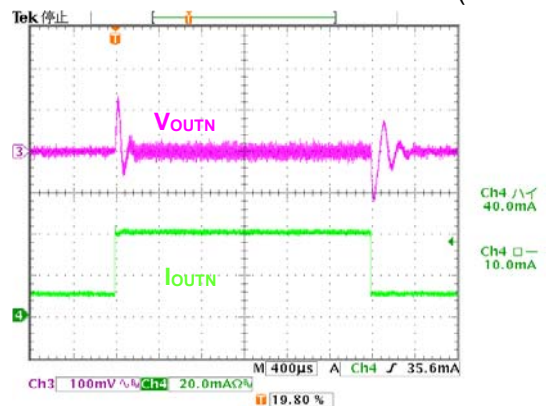

R1287x001D/H ($V_{OUTP} = 5.0\text{ V}$)
($T_a = 25^\circ\text{C}$)

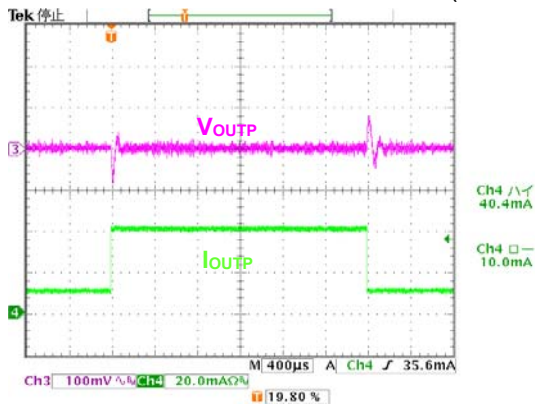

R1287x001D/H ($V_{OUTN} = -5.0\text{ V}$)
($T_a = 25^\circ\text{C}$)

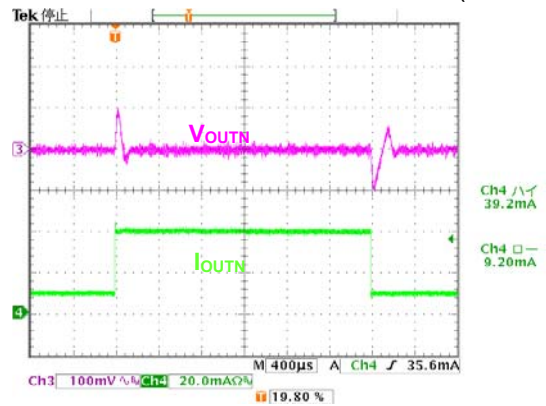

9) Standby Current vs. Temperature

R1287xxxxy

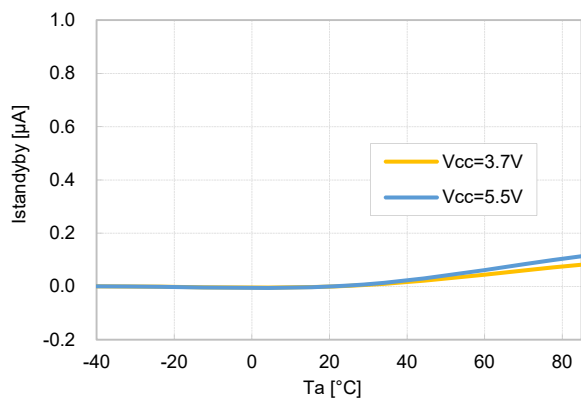

10) UVLO Voltage vs. Temperature

R1287xxxxy

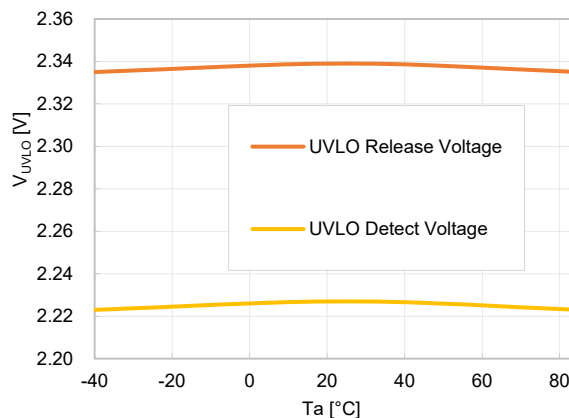

11) V_{OUTP} Voltage vs. Temperature

V_{CC} = 3.7 V

R1287x002y

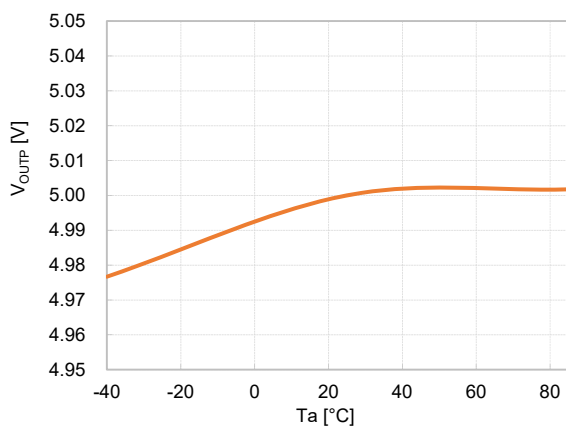

12) V_{OUTN} Voltage vs. Temperature

V_{CC} = 3.7 V

R1287x002y

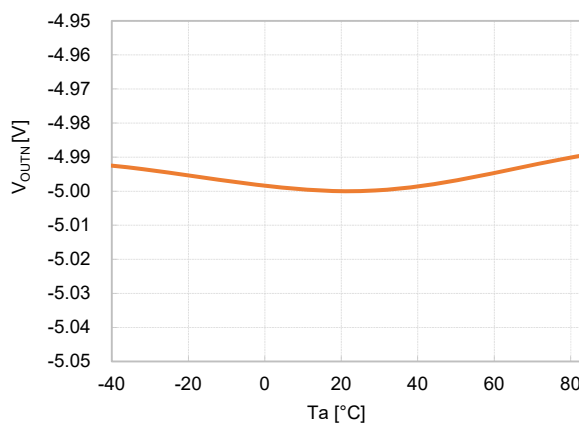

13) V_{FBP} Voltage vs. Temperature

V_{CC} = 3.7 V

R1287x001y

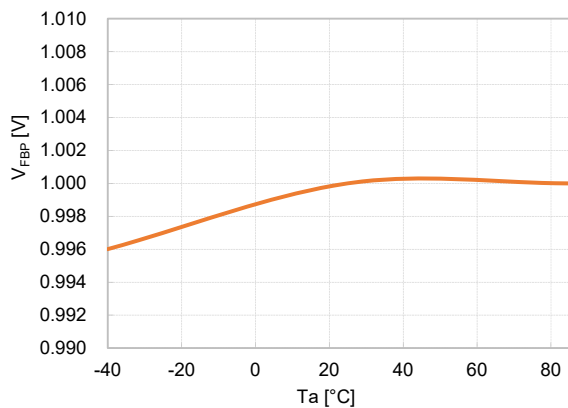

14) V_{FBN} Voltage vs. Temperature

V_{CC} = 3.7 V

R1287x001y

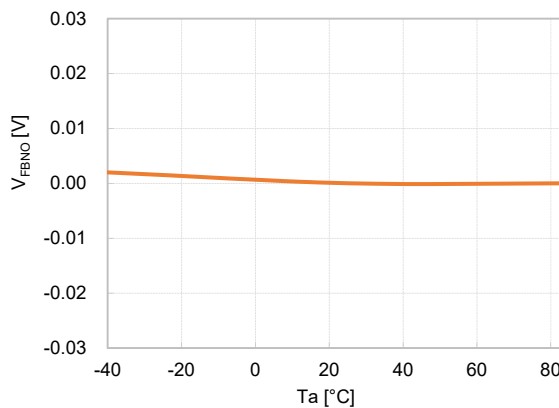

R1287x

NO.EA-325-180907

15) I_{FBN} Current vs. Temperature

$V_{CC} = 3.7\text{ V}$

R1287x001y

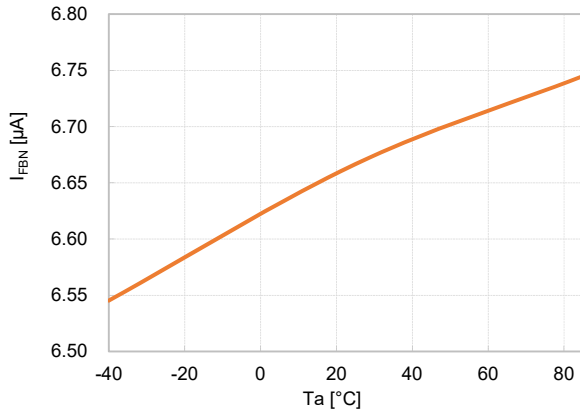

16) PWM Oscillator Frequency vs. Temperature

$V_{CC} = 3.7\text{ V}$

R1287xxxxC

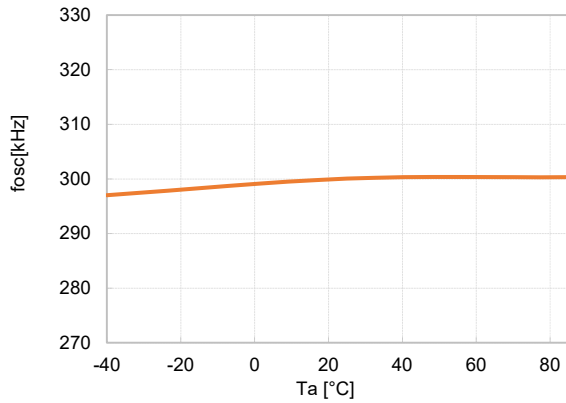

R1287xxxxD

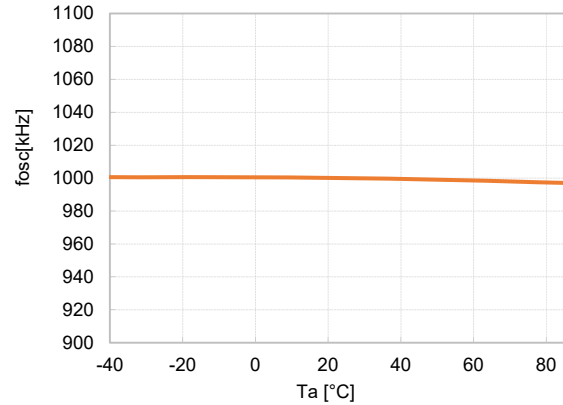

17) CH1 Maximum Duty Cycle vs. Temperature

$V_{CC} = 3.7\text{ V}$

R1287xxxxy

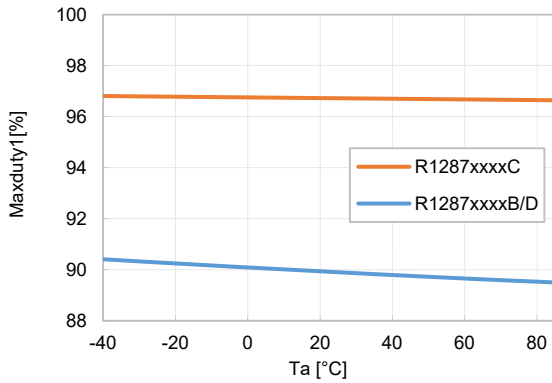

18) CH2 Maximum Duty Cycle vs. Temperature

$V_{CC} = 3.7\text{ V}$

R1287xxxxy

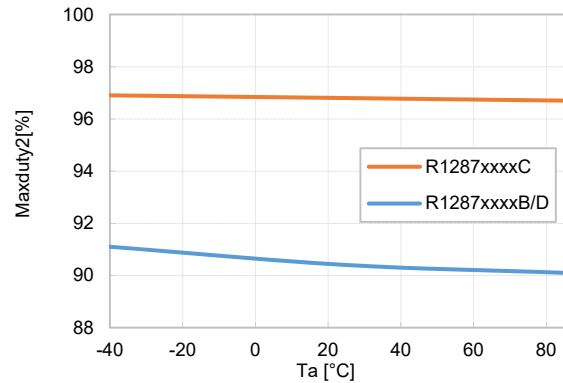

19) EN1 H/L Input Voltage vs. Temperature

V_{CC} = 3.7 V

R1287xxxxxy

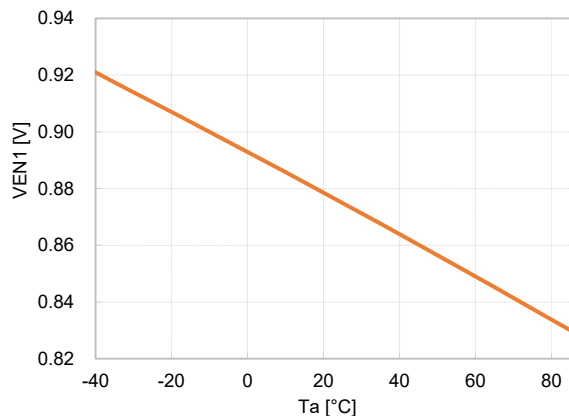

20) EN2 H/L Input Voltage vs. Temperature

V_{CC} = 3.7 V

R1287xxxxxy

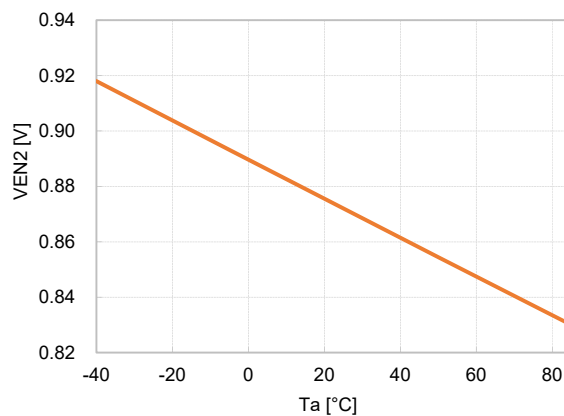

21) Boost Nch Current Limit vs. Temperature

R1287xxxxxy

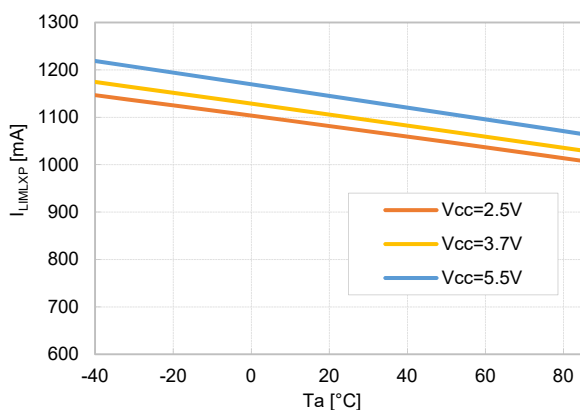

22) Inverting Pch Current Limit vs. Temperature

R1287xxxxxy

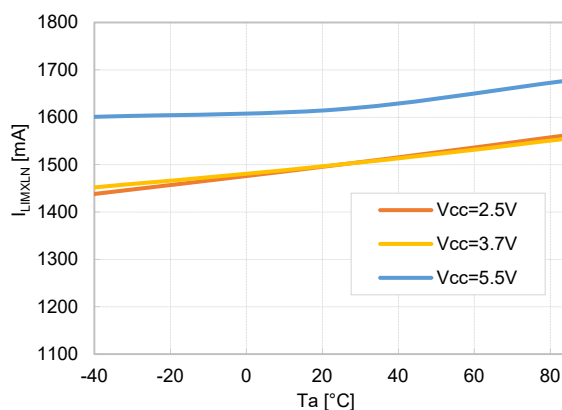

23) CH1 Soft-Start Time vs. Temperature

R1287xxxxxy

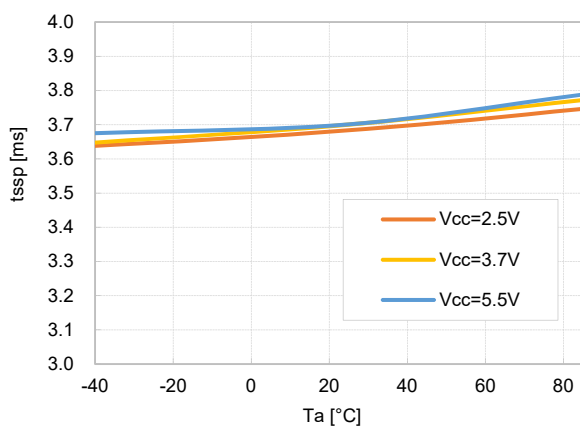

24) CH2 Soft-Start Time vs. Temperature

R1287xxxxxy

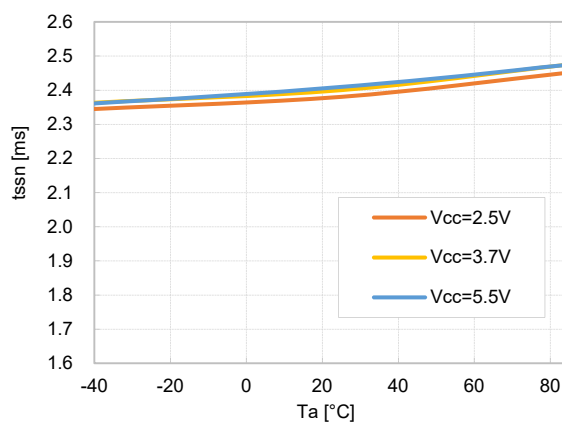

R1287x

NO.EA-325-180907

25) Delay Time for Protection vs. Temperature

$V_{CC} = 3.7\text{ V}$

R1287xxxxy

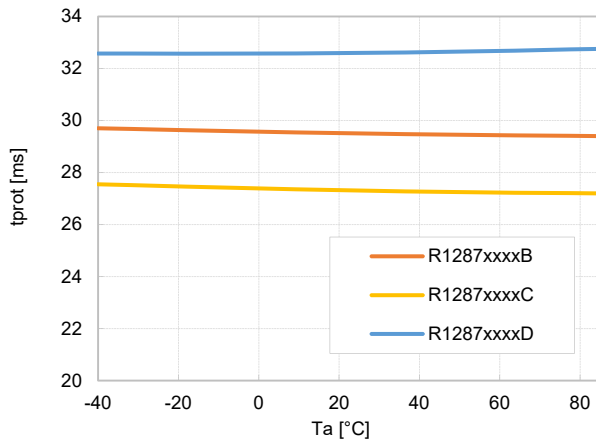

The power dissipation of the package is dependent on PCB material, layout, and environmental conditions. The following conditions are used in this measurement.

Measurement Conditions

	Standard Test Land Pattern
Environment	Mounting on Board (Wind Velocity = 0 m/s)
Board Material	Glass Cloth Epoxy Plastic (Double-sided)
Board Dimensions	40 mm x 40 mm x 1.6 mm
Copper Ratio	Top Side: Approx. 80% Bottom Side: Approx. 90%
Through-holes	φ 0.6 mm × 31 pcs

Measurement Result

(Ta = 25°C, Tjmax = 125°C)

	Standard Test Land Pattern
Power Dissipation	1000 mW
Thermal Resistance	$\theta_{ja} = (125 - 25^\circ\text{C}) / 1.0 \text{ W} = 100^\circ\text{C} / \text{W}$

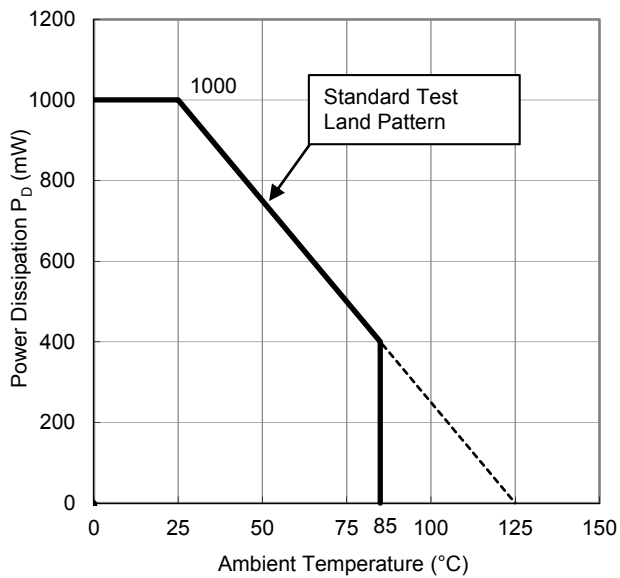

Power Dissipation vs. Ambient Temperature

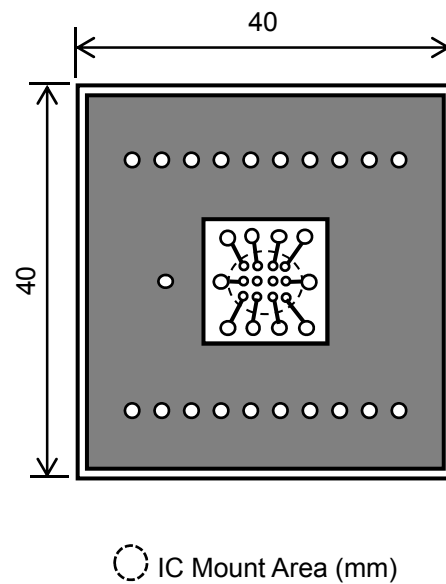

Measurement Board Pattern

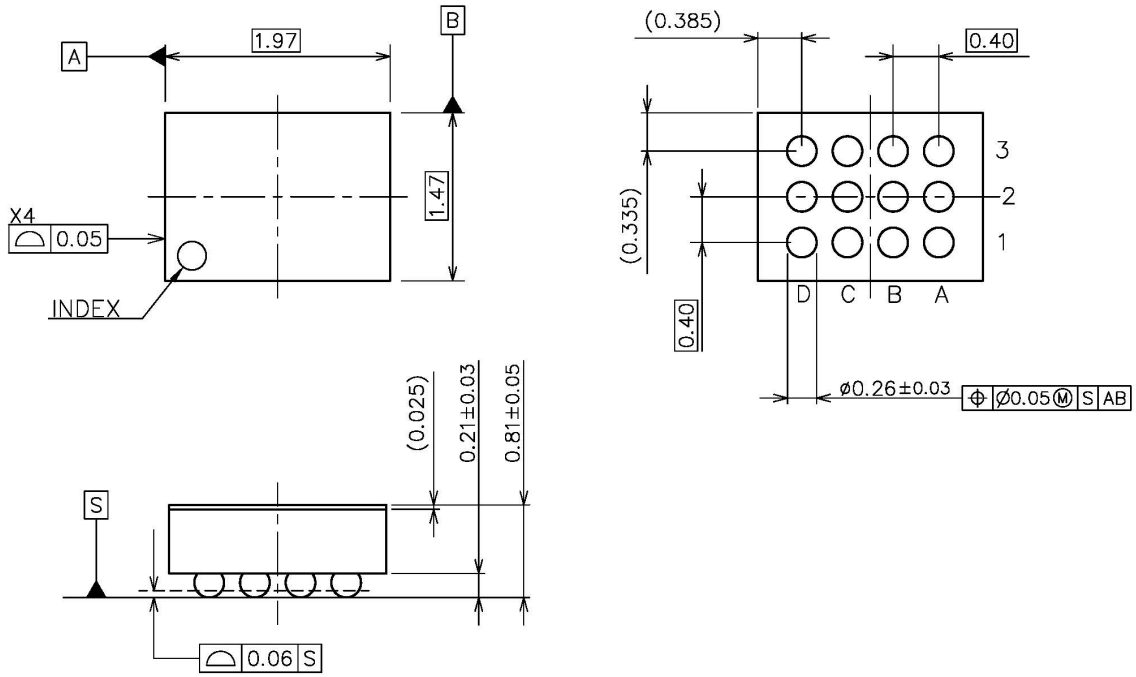

WLCSP-12-P1 Package Dimensions (Unit: mm)

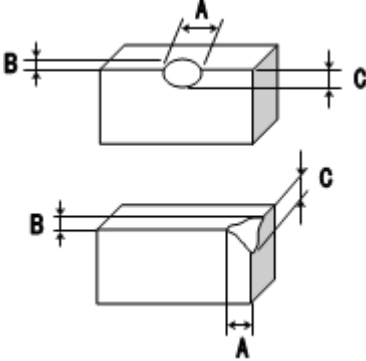
No.	Inspection Items	Inspection Criteria	Figure
1	Package chipping	A \geq 0.2mm is rejected B \geq 0.2mm is rejected C \geq 0.2mm is rejected And, Package chipping to Si surface and to bump is rejected.	
2	Si surface chipping	A \geq 0.2mm is rejected B \geq 0.2mm is rejected C \geq 0.2mm is rejected But, even if A \geq 0.2mm, B \leq 0.1mm is acceptable.	
3	No bump	No bump is rejected.	
4	Marking miss	To reject incorrect marking, such as another product name marking or another lot No. marking.	
5	No marking	To reject no marking on the package.	
6	Reverse direction of marking	To reject reverse direction of marking character.	
7	Defective marking	To reject unreadable marking. (Microscope: X15/ White LED/ Viewed from vertical direction)	
8	Scratch	To reject unreadable marking character by scratch. (Microscope: X15/ White LED/ Viewed from vertical direction)	
9	Stain and Foreign material	To reject unreadable marking character by stain and foreign material. (Microscope: X15/ White LED/ Viewed from vertical direction)	

The power dissipation of the package is dependent on PCB material, layout, and environmental conditions. The following measurement conditions are based on JEDEC STD. 51-7.

Measurement Conditions

Item	Measurement Conditions
Environment	Mounting on Board (Wind Velocity = 0 m/s)
Board Material	Glass Cloth Epoxy Plastic (Four-Layer Board)
Board Dimensions	76.2 mm × 114.3 mm × 0.8 mm
Copper Ratio	Outer Layer (First Layer): Less than 95% of 50 mm Square Inner Layers (Second and Third Layers): Approx. 100% of 50 mm Square Outer Layer (Fourth Layer): Approx. 100% of 50 mm Square
Through-holes	φ 0.3 mm × 32 pcs

Measurement Result

(Ta = 25°C, Tjmax = 125°C)

Item	Measurement Result
Power Dissipation	3400 mW
Thermal Resistance (θja)	θja = 29°C/W
Thermal Characterization Parameter (ψjt)	ψjt = 3.1°C/W

θja: Junction-to-Ambient Thermal Resistance

ψjt: Junction-to-Top Thermal Characterization Parameter

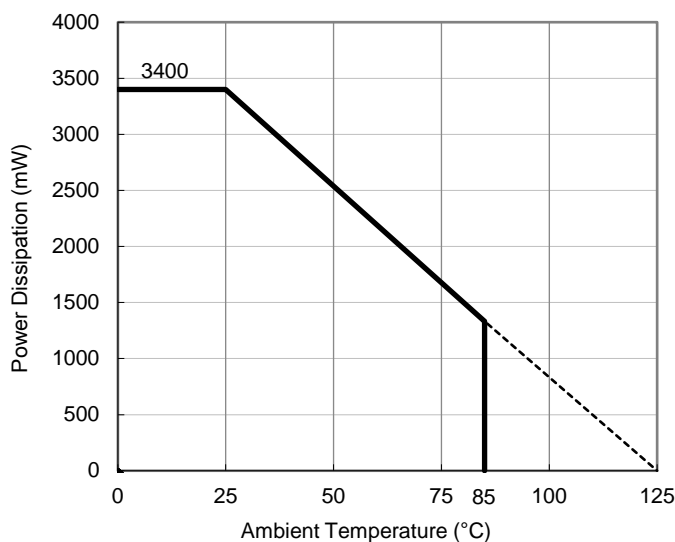

Power Dissipation vs. Ambient Temperature

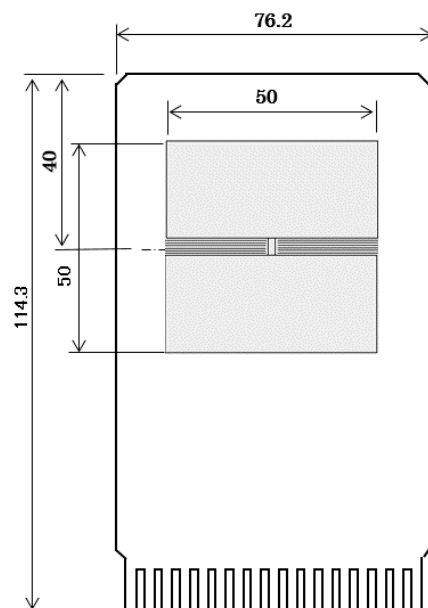

Measurement Board Pattern

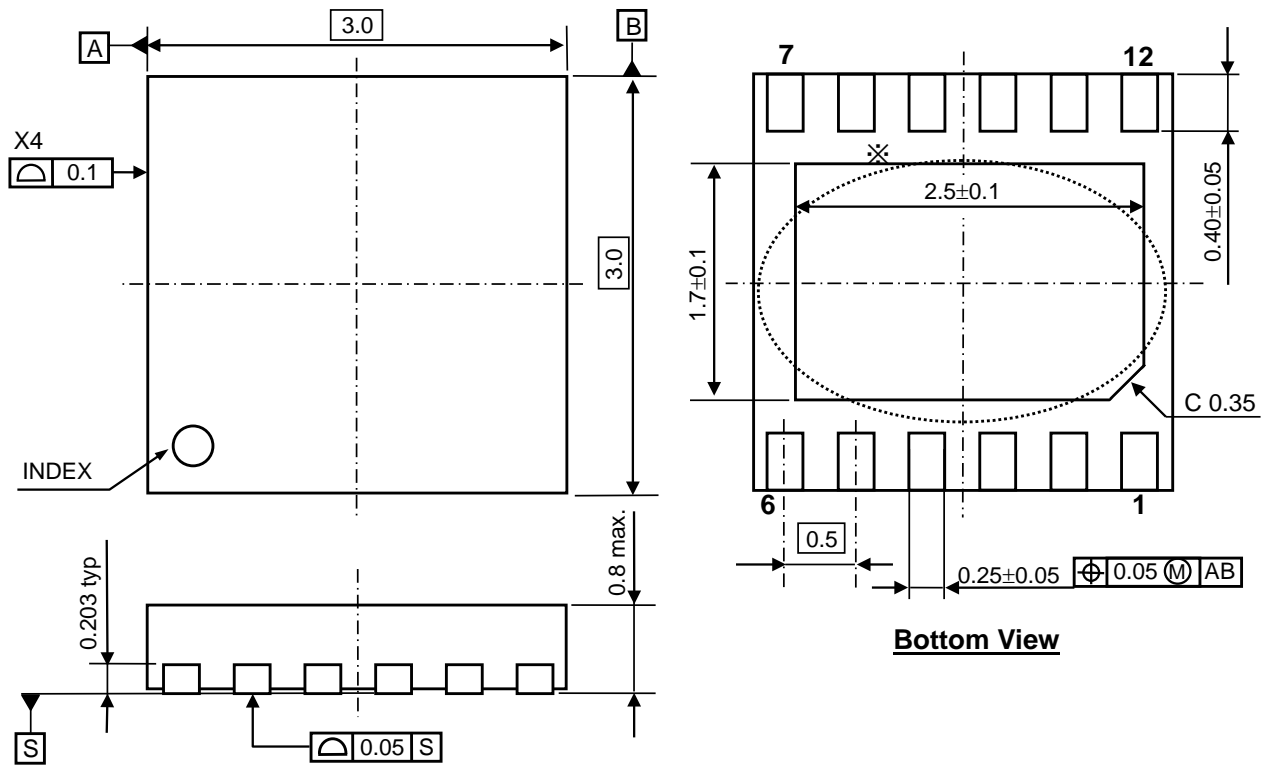

DFN3030-12 Package Dimensions (Unit: mm)

* The tab on the bottom of the package is substrate level (GND). It is recommended that the tab be connected to the ground plane on the board, or otherwise be left floating.



1. The products and the product specifications described in this document are subject to change or discontinuation of production without notice for reasons such as improvement. Therefore, before deciding to use the products, please refer to Ricoh sales representatives for the latest information thereon.
2. The materials in this document may not be copied or otherwise reproduced in whole or in part without prior written consent of Ricoh.
3. Please be sure to take any necessary formalities under relevant laws or regulations before exporting or otherwise taking out of your country the products or the technical information described herein.
4. The technical information described in this document shows typical characteristics of and example application circuits for the products. The release of such information is not to be construed as a warranty of or a grant of license under Ricoh's or any third party's intellectual property rights or any other rights.
5. The products listed in this document are intended and designed for use as general electronic components in standard applications (office equipment, telecommunication equipment, measuring instruments, consumer electronic products, amusement equipment etc.). Those customers intending to use a product in an application requiring extreme quality and reliability, for example, in a highly specific application where the failure or misoperation of the product could result in human injury or death (aircraft, spacevehicle, nuclear reactor control system, traffic control system, automotive and transportation equipment, combustion equipment, safety devices, life support system etc.) should first contact us.
6. We are making our continuous effort to improve the quality and reliability of our products, but semiconductor products are likely to fail with certain probability. In order to prevent any injury to persons or damages to property resulting from such failure, customers should be careful enough to incorporate safety measures in their design, such as redundancy feature, fire containment feature and fail-safe feature. We do not assume any liability or responsibility for any loss or damage arising from misuse or inappropriate use of the products.
7. Anti-radiation design is not implemented in the products described in this document.
8. The X-ray exposure can influence functions and characteristics of the products. Confirm the product functions and characteristics in the evaluation stage.
9. WLCSP products should be used in light shielded environments. The light exposure can influence functions and characteristics of the products under operation or storage.
10. There can be variation in the marking when different AOI (Automated Optical Inspection) equipment is used. In the case of recognizing the marking characteristic with AOI, please contact Ricoh sales or our distributor before attempting to use AOI.
11. Please contact Ricoh sales representatives should you have any questions or comments concerning the products or the technical information.



Ricoh is committed to reducing the environmental loading materials in electrical devices with a view to contributing to the protection of human health and the environment.

Ricoh has been providing RoHS compliant products since April 1, 2006 and Halogen-free products since April 1, 2012.

RICOH RICOH ELECTRONIC DEVICES CO., LTD.

<https://www.e-devices.ricoh.co.jp/en/>

Sales & Support Offices

Ricoh Electronic Devices Co., Ltd.

Shin-Yokohama Office (International Sales)

2-3, Shin-Yokohama 3-chome, Kohoku-ku, Yokohama-shi, Kanagawa, 222-8530, Japan
Phone: +81-50-3814-7687 Fax: +81-45-474-0074

Ricoh Americas Holdings, Inc.

675 Campbell Technology Parkway, Suite 200 Campbell, CA 95008, U.S.A.
Phone: +1-408-610-3105

Ricoh Europe (Netherlands) B.V.

Semiconductor Support Centre

Prof. W.H. Keesomlaan 1, 1183 DJ Amstelveen, The Netherlands
Phone: +31-20-5474-309

Ricoh International B.V. - German Branch

Semiconductor Sales and Support Centre

Oberrather Strasse 6, 40472 Düsseldorf, Germany
Phone: +49-211-6546-0

Ricoh Electronic Devices Korea Co., Ltd.

3F, Haesung Bldg, 504, Teheran-ro, Gangnam-gu, Seoul, 135-725, Korea
Phone: +82-2-2135-5700 Fax: +82-2-2051-5713

Ricoh Electronic Devices Shanghai Co., Ltd.

Room 403, No.2 Building, No.690 Bibo Road, Pu Dong New District, Shanghai 201203,
People's Republic of China
Phone: +86-21-5027-3200 Fax: +86-21-5027-3299

Ricoh Electronic Devices Shanghai Co., Ltd.

Shenzhen Branch

1205, Block D (Jinlong Building), Kingkey 100, Hongbao Road, Luohu District,
Shenzhen, China
Phone: +86-755-8348-7600 Ext 225

Ricoh Electronic Devices Co., Ltd.

Taipei office

Room 109, 10F-1, No.51, Hengyang Rd., Taipei City, Taiwan
Phone: +886-2-2313-1621/1622 Fax: +886-2-2313-1623

X-ON Electronics

Largest Supplier of Electrical and Electronic Components

Click to view similar products for [Switching Voltage Regulators](#) category:

Click to view products by [Nisshinbo](#) manufacturer:

Other Similar products are found below :

[FAN53610AUC33X](#) [FAN53611AUC123X](#) [FAN48610BUC33X](#) [FAN48610BUC45X](#) [FAN48617UC50X](#) [R3](#) [430464BB](#) [KE177614](#)
[FAN53611AUC12X](#) [MAX809TTR](#) [NCV891234MW50R2G](#) [NCP81103MNTXG](#) [NCP81203PMNTXG](#) [NCP81208MNTXG](#)
[NCP81109GMNTXG](#) [SCY1751FCCT1G](#) [NCP81109JMNTXG](#) [AP3409ADNTR-G1](#) [NCP81241MNTXG](#) [LTM8064IY](#) [LT8315EFE#TRPBF](#)
[LTM4664EY#PBF](#) [LTM4668AIY#PBF](#) [NCV1077CSTBT3G](#) [XCL207A123CR-G](#) [MPM54304GMN-0002](#) [MPM54304GMN-0004](#)
[MPM54304GMN-0003](#) [AP62300Z6-7](#) [MP8757GL-P](#) [MIC23356YFT-TR](#) [LD8116CGL](#) [HG2269M/TR](#) [OB2269](#) [XD3526](#) [U6215A](#) [U6215B](#)
[U6620S](#) [LTC3412IFE](#) [LT1425IS](#) [MAX25203BATJA/VY+](#) [MAX77874CEWM+](#) [XC9236D08CER-G](#) [MP3416GJ-P](#) [MP5461GC-Z](#)
[MPQ4590GS-Z](#) [MAX38640BENT18+T](#) [MAX77511AEWB+](#) [MAX20406AFOD/VY+](#) [MAX20408AFOC/VY+](#)