

## 300mA 36V Input Regulator

NO.EA-300-221111

### OUTLINE

The R1511x Series are CMOS-based high-voltage resistant and fast response voltage regulators that provide the minimum 300mA of output current. Internally, R1511x consists of an Output Short-circuit Protection Circuit, an Over-current Protection Circuit, and a Thermal Shutdown Circuit in addition to the basic regulator circuits. The operating temperature range is between  $-40^{\circ}\text{C}$  to  $+105^{\circ}\text{C}$ , and the maximum input voltage is 36V. All these features allow the R1511x Series to become an ideal power source of electric home appliances.

R1511x is available in B version (R1511xxxxB) with the fixed output voltage type, and C version (R1511x001C) with adjustable output voltage type with external resistors. The output voltage accuracy is  $\pm 1.0\%$ .

R1511x is available in two types of packages: HSOP-6J for high-density mounting and TO-252-5-P2 for high wattage.

### FEATURES

- Input Voltage Range ..... 3.5V to 36V
- Supply Current ..... Typ. 100 $\mu\text{A}$
- Supply Current (Standby Mode) ..... Typ. 0.1 $\mu\text{A}$  (R1511xxxxB)
- Output Voltage Range ..... R1511xxxxB: 3.0V to 9.0V (0.1V step)  
 (For other voltages, please refer to MARK INFORMATIONS.)  
 R1511xxxxC: 3.0V to 12.0V
- Output Voltage Accuracy ..... R1511xxxxB:  $\pm 1.0\%$  ( $T_a=25^{\circ}\text{C}$ )
- Feed Back Voltage ..... R1511xxxxC: 3.0V  $\pm 1.0\%$  ( $T_a=25^{\circ}\text{C}$ )
- Output Voltage Temperature-Drift Coefficient ..... Typ.  $\pm 60\text{ppm}/^{\circ}\text{C}$
- Line Regulation ..... Typ. 0.01%/V ( $V_{\text{DD}}=V_{\text{OUT}}+0.5\text{V}$  to 36V)
- Dropout Voltage ..... Typ. 0.64V ( $I_{\text{OUT}}=300\text{mA}$ ,  $V_{\text{OUT}}=5.0\text{V}$ )
- Package Option ..... HSOP-6J, TO-252-5-P2
- Built-in Output Short-circuit Protection Circuit ..... Typ. 50mA
- Built-in Over-current Protection Circuit ..... Typ. 450mA
- Built-in Thermal Shutdown Circuit ..... Thermal Shutdown Temperature: Typ.  $160^{\circ}\text{C}$
- Operating Temperature Range .....  $-40$  to  $+105^{\circ}\text{C}$
- Ripple Rejection ..... Typ. 65dB (1kHz)
- Ceramic capacitors are recommended to be used with this IC  
 .....  $C_{\text{IN}}=1.0\mu\text{F}$  or more,  $C_{\text{OUT}}=6.8\mu\text{F}$  or more

### APPLICATIONS

- For home electrical appliances: refrigerators, rice cookers, electrical pots, etc.
- For digital equipments: laptop PCs, digital TVs, telephone equipments, home LAN systems, etc.
- For OA equipments: copy machines, printers, fax machines, scanners, projectors, etc.

## BLOCK DIAGRAMS

R1511xxxxB

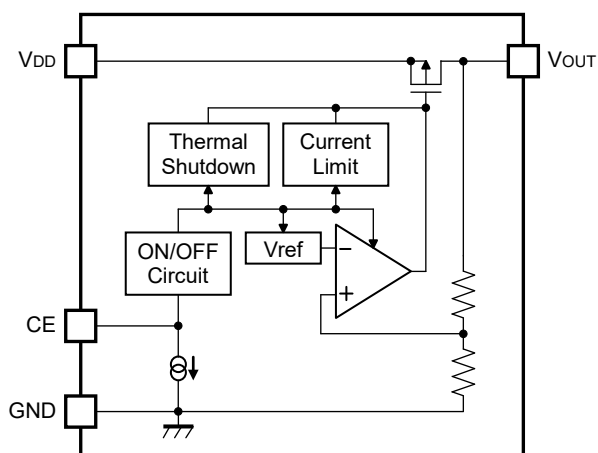

R1511x001C

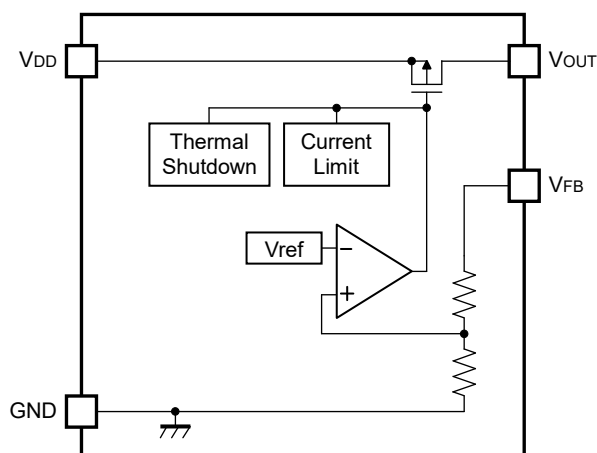

## SELECTION GUIDE

The output voltage, version and the package type for the ICs can be selected at the user's request.

Product Name	Package	Quantity per Reel	Pb Free	Halogen Free
R1511Sxxx*-E2-FE	HSOP-6J	1,000pcs	Yes	Yes
R1511Jxxx*-T1-FE	TO-252-5-P2	3,000pcs	Yes	Yes

xxx : Specify the output setting voltage ( $V_{SET}$ )

R1511xxxxB: Specify the output voltage within the range of 3.0V (030) to 9.0V (090) in 0.1V steps.  
(For other voltages, please refer to MARK INFORMATION.)

R1511x001C: only (001)

\* : Specify the version

(B) Fixed output and Built-in Chip Enable ("H" active)

(C) Adjustable output

## PIN CONFIGURATIONS

### • HSOP-6J

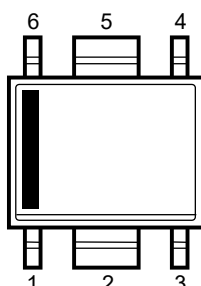

### • TO-252-5-P2

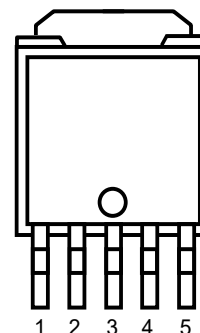

## PIN DESCRIPTIONS

### R1511S:HSOP-6J

Pin No.	Symbol	Description	
1	V <sub>DD</sub>	Input Pin	
2	GND*	Ground Pin	
3	GND*	Ground Pin	
4	CE	R1511SxxxB	Chip Enable Pin ("H" Active)
	V <sub>FB</sub>	R1511S001C	Feed Back Pin
5	GND*	Ground Pin	
6	V <sub>OUT</sub>	Output Pin	

\*) No. 2, No. 3 and No. 5 pins must be wired to the GND plane when they are mounted on board.

### R1511J:TO-252-5-P2

Pin No.	Symbol	Description	
1	V <sub>DD</sub>	Input Pin	
2	GND*	Ground Pin	
3	GND*	Ground Pin	
4	CE	R1511JxxxB	Chip Enable Pin ("H" Active)
	V <sub>FB</sub>	R1511J001C	Feed Back Pin
5	V <sub>OUT</sub>	Output Pin	

\*) No. 2 and No. 3 pins must be wired to the GND plane when they are mounted on board.

## PIN EQUIVALENT CIRCUIT DIAGRAMS

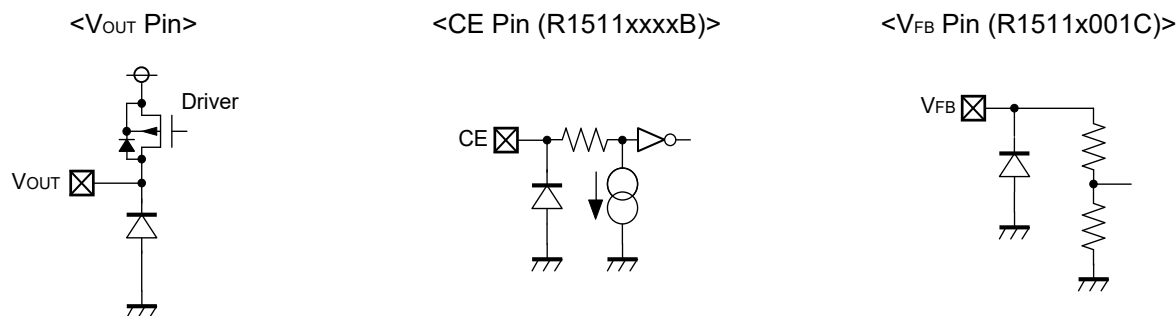

## ABSOLUTE MAXIMUM RATINGS

Symbol	Item	Rating		Unit
$V_{IN}$	Input Voltage	-0.3 to 50		V
$V_{IN}$	Peak Input Voltage*1	60		V
$V_{CE}$	Input Voltage (CE Pin)	-0.3 to 50		V
$V_{FB}$	Input Voltage ( $V_{FB}$ Pin)	-0.3 to 50		V
$V_{OUT}$	Output Voltage	-0.3 to $V_{IN}+0.3 \leq 50$		V
$P_D$	Power Dissipation (JEDEC STD. 51-7)*2	HSOP-6J	2700	mW
		TO-252-5-P2	3800	
$T_j$	Operating Junction Temperature Range	-40 to +125		°C
$T_{stg}$	Storage Temperature Range	-55 to +125		°C

\*1) Duration time: 200ms

\*2) For Power Dissipation, please refer to next page to be described.

### ABSOLUTE MAXIMUM RATINGS

Electronic and mechanical stress momentarily exceeded absolute maximum ratings may cause the permanent damages and may degrade the lifetime and safety for both device and system using the device in the field. The functional operation at or over these absolute maximum ratings are not assured.

## RECOMMENDED OPERATING CONDITIONS

Symbol	Item	Rating	Unit
$T_a$	Operating Temperature Range	-40 to +105	°C

### RECOMMENDED OPERATING CONDITIONS (ELECTRICAL CHARACTERISTICS)

All of electronic equipment should be designed that the mounted semiconductor devices operate within the recommended operating conditions. The semiconductor devices cannot operate normally over the recommended operating conditions, even if when they are used over such conditions by momentary electronic noise or surge. And the semiconductor devices may receive serious damage when they continue to operate over the recommended operating conditions.

## Power Dissipation (HSOP-6J)

The power dissipation of the package is dependent on PCB material, layout, and environmental conditions. The following measurement conditions are based on JEDEC STD. 51-7.

### Measurement Conditions

Item	Measurement Conditions
Environment	Mounting on Board (Wind Velocity = 0 m/s)
Board Material	Glass Cloth Epoxy Plastic (Four-Layer Board)
Board Dimensions	76.2 mm × 114.3 mm × 0.8 mm
Copper Ratio	Outer Layer (First Layer): Less than 95% of 50 mm Square Inner Layers (Second and Third Layers): Approx. 100% of 50 mm Square Outer Layer (Fourth Layer): Approx. 100% of 50 mm Square
Through-holes	φ 0.3 mm × 28 pcs

### Measurement Result

( $T_a = 25^\circ\text{C}$ ,  $T_{j\text{max}} = 125^\circ\text{C}$ )

Item	Measurement Result
Power Dissipation	2700 mW
Thermal Resistance ( $\theta_{ja}$ )	$\theta_{ja} = 37^\circ\text{C/W}$
Thermal Characterization Parameter ( $\psi_{jt}$ )	$\psi_{jt} = 7^\circ\text{C/W}$

$\theta_{ja}$ : Junction-to-Ambient Thermal Resistance

$\psi_{jt}$ : Junction-to-Top Thermal Characterization Parameter

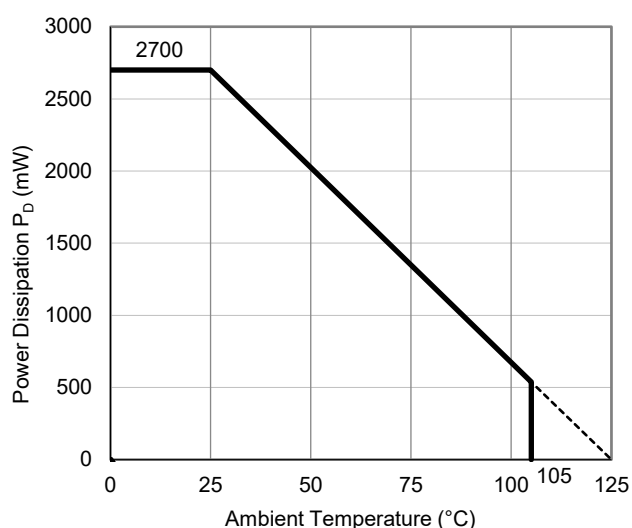

Power Dissipation vs. Ambient Temperature

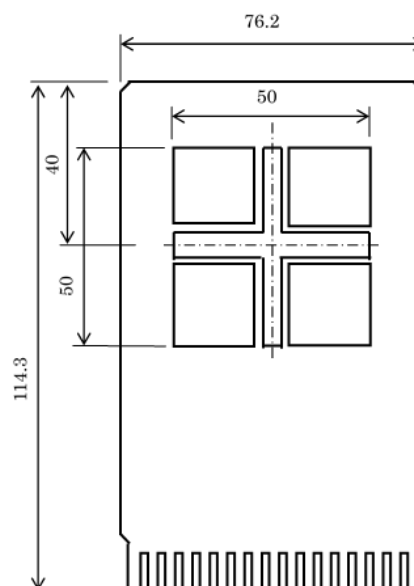

Measurement Board Pattern

## Power Dissipation (TO-252-5-P2)

The power dissipation of the package is dependent on PCB material, layout, and environmental conditions. The following measurement conditions are based on JEDEC STD. 51-7.

### Measurement Conditions

Item	Measurement Conditions
Environment	Mounting on Board (Wind Velocity = 0 m/s)
Board Material	Glass Cloth Epoxy Plastic (Four-Layer Board)
Board Dimensions	76.2 mm × 114.3 mm × 0.8 mm
Copper Ratio	Outer Layer (First Layer): Less than 95% of 50 mm Square Inner Layers (Second and Third Layers): Approx. 100% of 50 mm Square Outer Layer (Fourth Layer): Approx. 100% of 50 mm Square
Through-holes	φ 0.3 mm × 21 pcs

### Measurement Result

( $T_a = 25^\circ\text{C}$ ,  $T_{j\text{max}} = 125^\circ\text{C}$ )

Item	Measurement Result
Power Dissipation	3800 mW
Thermal Resistance ( $\theta_{ja}$ )	$\theta_{ja} = 26^\circ\text{C/W}$
Thermal Characterization Parameter ( $\psi_{jt}$ )	$\psi_{jt} = 7^\circ\text{C/W}$

$\theta_{ja}$ : Junction-to-Ambient Thermal Resistance

$\psi_{jt}$ : Junction-to-Top Thermal Characterization Parameter

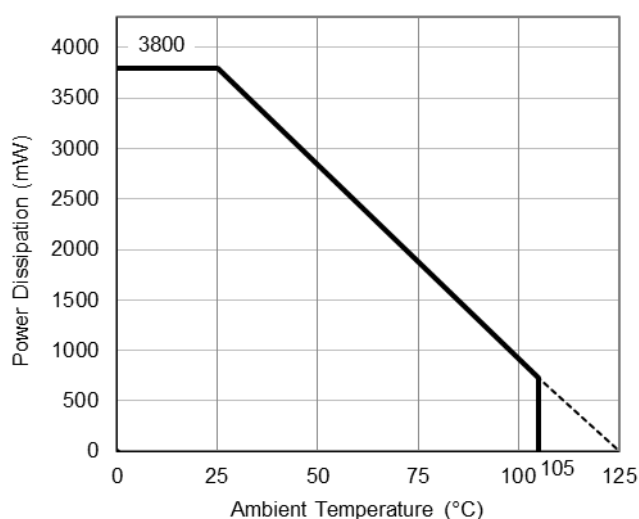

Power Dissipation vs. Ambient Temperature

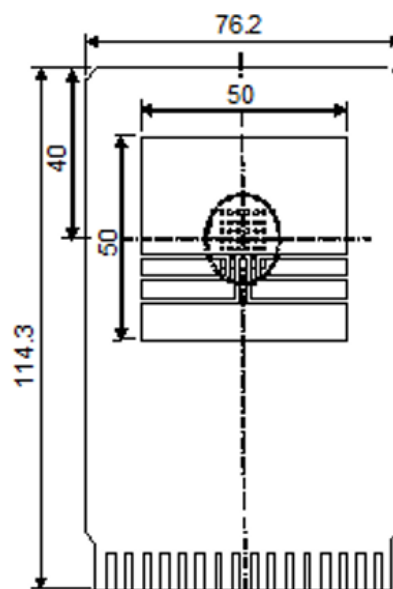

Measurement Board Pattern

## ELECTRICAL CHARACTERISTICS

$C_{IN}=1.0\mu F$ ,  $C_{OUT}=6.8\mu F$ , unless otherwise noted.

The specification surrounded by   are guaranteed by design engineering at  $-40^{\circ}C \leq T_a \leq +105^{\circ}C$ .

R1511xxxxB

( $T_a=25^{\circ}C$ )

Symbol	Item	Conditions	Min.	Typ.	Max.	Unit	
$V_{IN}$	Input Voltage		<span style="border: 1px solid black; padding: 0 2px;">3.5</span>		<span style="border: 1px solid black; padding: 0 2px;">36</span>	V	
$I_{SS}$	Supply Current	$V_{IN}=V_{SET}+1.0V$ , $I_{OUT}=0mA$		100	<span style="border: 1px solid black; padding: 0 2px;">180</span>	$\mu A$	
$I_{standby}$	Standby Current	$V_{IN}=36V$ , $V_{CE}=0V$		0.1	2.0	$\mu A$	
$V_{OUT}$	Output Voltage	$V_{IN}=V_{SET}+2.0V$ $I_{OUT}=1mA$	$T_a=25^{\circ}C$	$\times 0.99$	$\times 1.01$	V	
			$-40^{\circ}C \leq T_a \leq +105^{\circ}C$	<span style="border: 1px solid black; padding: 0 2px;"><math>\times 0.98</math></span>	<span style="border: 1px solid black; padding: 0 2px;"><math>\times 1.02</math></span>		
$\frac{\Delta V_{OUT}}{\Delta I_{OUT}}$	Load Regulation	$V_{IN}=V_{SET}+2.0V$ $1mA \leq I_{OUT} \leq 300mA$	$V_{SET} \leq 5.0V$	<span style="border: 1px solid black; padding: 0 2px;">-20</span>	<span style="border: 1px solid black; padding: 0 2px;">100</span>	mV	
			$5.0V < V_{SET}$	<span style="border: 1px solid black; padding: 0 2px;">-20</span>	<span style="border: 1px solid black; padding: 0 2px;">120</span>		
$\frac{\Delta V_{OUT}}{\Delta V_{IN}}$	Line Regulation	$V_{SET}+0.5V \leq V_{IN} \leq 36V$ , $I_{OUT}=1mA$		0.01	<span style="border: 1px solid black; padding: 0 2px;">0.02</span>	%/V	
$V_{DIF}$	Dropout Voltage	$I_{OUT}=300mA$	$3.0V \leq V_{SET} \leq 3.1V$		0.98	<span style="border: 1px solid black; padding: 0 2px;">1.5</span>	V
			$3.1V < V_{SET} \leq 3.4V$		0.94	<span style="border: 1px solid black; padding: 0 2px;">1.4</span>	
			$3.4V < V_{SET} \leq 3.8V$		0.88	<span style="border: 1px solid black; padding: 0 2px;">1.3</span>	
			$3.8V < V_{SET} \leq 4.3V$		0.79	<span style="border: 1px solid black; padding: 0 2px;">1.2</span>	
			$4.3V < V_{SET} \leq 4.9V$		0.71	<span style="border: 1px solid black; padding: 0 2px;">1.1</span>	
			$4.9V < V_{SET} \leq 5.7V$		0.64	<span style="border: 1px solid black; padding: 0 2px;">1.0</span>	
			$5.7V < V_{SET} \leq 6.8V$		0.59	<span style="border: 1px solid black; padding: 0 2px;">0.9</span>	
			$6.8V < V_{SET} \leq 8.3V$		0.54	<span style="border: 1px solid black; padding: 0 2px;">0.8</span>	
		$8.3V < V_{SET} \leq 9.0V$		0.47	<span style="border: 1px solid black; padding: 0 2px;">0.7</span>		
$\frac{\Delta V_{OUT}}{\Delta T_a}$	Output Voltage Temperature Coefficient	$V_{IN}=V_{SET}+2.0V$ , $I_{OUT}=1mA$ $-40^{\circ}C \leq T_a \leq +105^{\circ}C$		$\pm 60$		ppm/ $^{\circ}C$	
$I_{LIM}$	Output Current Limit	$V_{IN}=V_{SET}+2.5V$		450		mA	
$I_{SC}$	Short Current Limit	$V_{OUT}=0V$		50		mA	
RR	Ripple Rejection	$f=1kHz$ , Ripple=0.5Vpp $I_{OUT}=10mA$ , $V_{IN}=V_{SET}+2.0V$		65		dB	
$V_{CEH}$	CE Input Voltage "H"		<span style="border: 1px solid black; padding: 0 2px;">2.2</span>		36	V	
$V_{CEL}$	CE Input Voltage "L"		0		<span style="border: 1px solid black; padding: 0 2px;">1.0</span>	V	
$I_{PD}$	CE Pull-down Current	$V_{CE}=5.0V$		0.2	<span style="border: 1px solid black; padding: 0 2px;">0.6</span>	$\mu A$	
		$V_{CE}=36V$		0.5	<span style="border: 1px solid black; padding: 0 2px;">1.3</span>		
$T_{TSD}$	Thermal Shutdown Temperature	Junction Temperature		160		$^{\circ}C$	
$T_{TSR}$	Thermal Shutdown Released Temperature	Junction Temperature		135		$^{\circ}C$	

All test items listed under Electrical Characteristics are done under the pulse load condition ( $T_J \approx T_a=25^{\circ}C$ ) except for Ripple Rejection and Output Voltage Temperature Coefficient.

$C_{IN}=1.0\mu F$ ,  $C_{OUT}=6.8\mu F$ ,  $V_{OUT}=V_{FB}$ , unless otherwise noted.

The specification surrounded by   are guaranteed by design engineering at  $-40^{\circ}C \leq T_a \leq +105^{\circ}C$ .

## R1511x001C

(Ta=25°C)

Symbol	Item	Conditions	Min.	Typ.	Max.	Unit
$V_{IN}$	Input Voltage		<span style="border: 1px solid black; padding: 0 2px;">3.5</span>		<span style="border: 1px solid black; padding: 0 2px;">36</span>	V
$I_{SS}$	Supply Current	$V_{IN}=4.0V$ , $I_{OUT}=0mA$		100	<span style="border: 1px solid black; padding: 0 2px;">180</span>	$\mu A$
$V_{OUT}$	Output Voltage	$V_{IN}=5.0V$ $I_{OUT}=1mA$	$T_a=25^{\circ}C$	2.97	3.03	V
			$-40^{\circ}C \leq T_a \leq +105^{\circ}C$	<span style="border: 1px solid black; padding: 0 2px;">2.94</span>	<span style="border: 1px solid black; padding: 0 2px;">3.06</span>	
$\Delta V_{OUT} / \Delta I_{OUT}$	Load Regulation	$V_{IN}=5.0V$ $1mA \leq I_{OUT} \leq 300mA$	<span style="border: 1px solid black; padding: 0 2px;">-20</span>		<span style="border: 1px solid black; padding: 0 2px;">40</span>	mV
$\Delta V_{OUT} / \Delta V_{IN}$	Line Regulation	$V_{SET}+0.5V \leq V_{IN} \leq 36V$ $I_{OUT}=1mA$		0.01	<span style="border: 1px solid black; padding: 0 2px;">0.02</span>	%/V
$V_{DIF}$	Dropout Voltage	$I_{OUT}=300mA$		0.98	<span style="border: 1px solid black; padding: 0 2px;">1.5</span>	V
$\Delta V_{OUT} / \Delta T_a$	Output Voltage Temperature Coefficient	$V_{IN}=V_{SET}+2.0V$ , $I_{OUT}=1mA$ $-40^{\circ}C \leq T_a \leq +105^{\circ}C$		$\pm 60$		ppm/ $^{\circ}C$
$I_{LIM}$	Output Current Limit	$V_{IN}=V_{SET}+2.5V$		450		mA
$I_{SC}$	Short Current Limit	$V_{OUT}=0V$		50		mA
RR	Ripple Rejection	$f=1kHz$ , Ripple=0.5Vpp $I_{OUT}=10mA$ , $V_{IN}=V_{SET}+2.0V$		65		dB
$R_{FB}$	$V_{FB}$ Pin Resistance		<span style="border: 1px solid black; padding: 0 2px;">1.0</span>	3.0		$M\Omega$
$T_{TSD}$	Thermal Shutdown Temperature	Junction Temperature		160		$^{\circ}C$
$T_{TSR}$	Thermal Shutdown Released Temperature	Junction Temperature		135		$^{\circ}C$

All test items listed under Electrical Characteristics are done under the pulse load condition ( $T_j=T_a=25^{\circ}C$ ) except for Ripple Rejection and Output Voltage Temperature Coefficient.



## TYPICAL APPLICATIONS

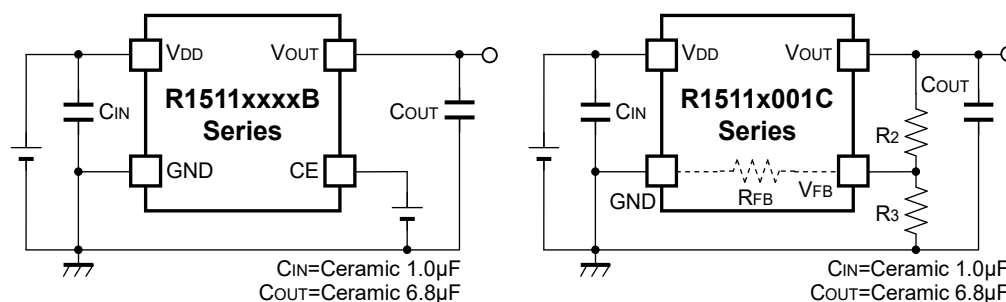

## NOTES CONCERNING EXTERNAL PARTS

### Phase Compensation

In the R1511x Series, phase compensation is provided to secure stable operation even when the load current is varied. For this purpose, please make sure to use a  $C_{OUT}$  capacitor.

In case of using a tantalum type capacitor and the ESR (Equivalent Series Resistance) value of the capacitor is large, the output might be unstable. Evaluate the circuit including consideration of frequency characteristics.

Depending on the capacitor size, manufacturer, and part number, the bias characteristics and temperature characteristics are different. Evaluate the circuit taking actual characteristics into account.

### PCB Layout and GND Wiring

Ensure the  $V_{DD}$  and GND lines are sufficiently robust. If their impedance is too high, noise pickup or unstable operation may result. Connect a  $C_{IN}$  capacitor with 1.0 $\mu$ F or more value between the  $V_{DD}$  and GND pins, and as close as possible to the pins. Likewise, connect a  $C_{OUT}$  capacitor with suitable values between the  $V_{OUT}$  and GND pins, and as close as possible to the pins (Please refer to the Typical Application above).

In the case of using HSOP-6J package, please make sure to wire No. 2, No. 3, and No. 5 pins to the GND plane. Also, in the case of using TO-252-5-P2 package, please make sure to wire No. 2 and No. 3 pins to the GND plane.

### Thermal Shutdown

R1511x contains a thermal shutdown circuit, which stops regulator operation if the junction temperature of R1511x becomes higher than 160°C (Typ.). Additionally, if the junction temperature after the regulator being stopped decreases to a level below 135°C (Typ.), it restarts regulator operation. As a result the operation of the thermal shutdown circuit causes the regulator repeatedly to turn off and on until the causes of overheating are removed. As a consequence a pulse shaped output voltage occurs.

### Output Voltage Setting Method (R1511x001C)

R1511x001C can be adjusted the output voltage up to 12.0V by using the external divider resistors. The output voltage can be calculated by the following equation.

$$V_{OUT} = V_{FB} \times (R_2 + R_3) / R_3$$

However, output voltage will be as large as " $R_2 \times I_{FB}$ " by the current flowing through the resistor in the IC. Because  $I_{FB} = V_{FB} / R_{FB}$ , " $R_2 \times I_{FB}$ " cause of error is as follows.

$$R_2 \times I_{FB} = R_2 \times V_{FB} / R_{FB} = V_{FB} \times R_2 / R_{FB}$$

For better accuracy, choosing  $R_2 \ll R_{FB}$  reduces this error.  $R_{FB}$  of R1511x is approximately min 1.0M  $\Omega$  (guaranteed by design).

Package Dimensions (HSOP-6J)

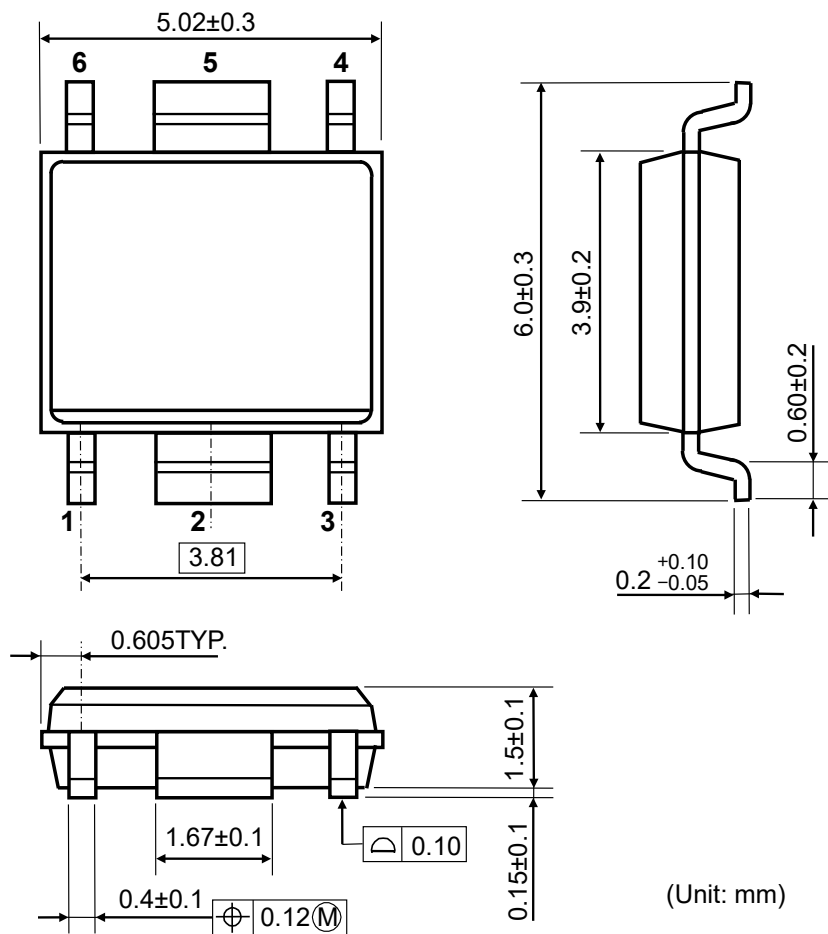

## Mark Specification (HSOP-6J)

①②③④: Product Code ... **Refer to R1511S Series Mark Specification Table**

⑤⑥ : Lot Number ... Alphanumeric Serial Number

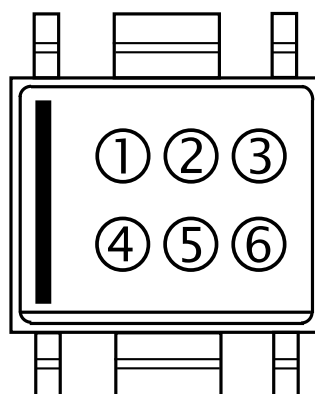

### NOTICE

There can be variation in the marking when different AOI (Automated Optical Inspection) equipment is used. In the case of recognizing the marking characteristic with AOI, please contact our sales or distributor before attempting to use AOI.

## R1511S Series Mark Specification Table

PKG: HSOP-6J

### R1511SxxxB Mark Specification Table

Product Name	①②③④	V <sub>SET</sub>
R1511S030B	<b>S 3 0 B</b>	3.0 V
R1511S031B	<b>S 3 1 B</b>	3.1 V
R1511S032B	<b>S 3 2 B</b>	3.2 V
R1511S033B	<b>S 3 3 B</b>	3.3 V
R1511S034B	<b>S 3 4 B</b>	3.4 V
R1511S035B	<b>S 3 5 B</b>	3.5 V
R1511S036B	<b>S 3 6 B</b>	3.6 V
R1511S037B	<b>S 3 7 B</b>	3.7 V
R1511S038B	<b>S 3 8 B</b>	3.8 V
R1511S039B	<b>S 3 9 B</b>	3.9 V
R1511S040B	<b>S 4 0 B</b>	4.0 V
R1511S041B	<b>S 4 1 B</b>	4.1 V
R1511S042B	<b>S 4 2 B</b>	4.2 V
R1511S043B	<b>S 4 3 B</b>	4.3 V
R1511S044B	<b>S 4 4 B</b>	4.4 V
R1511S045B	<b>S 4 5 B</b>	4.5 V
R1511S046B	<b>S 4 6 B</b>	4.6 V
R1511S047B	<b>S 4 7 B</b>	4.7 V
R1511S048B	<b>S 4 8 B</b>	4.8 V
R1511S049B	<b>S 4 9 B</b>	4.9 V
R1511S050B	<b>S 5 0 B</b>	5.0 V
R1511S051B	<b>S 5 1 B</b>	5.1 V
R1511S052B	<b>S 5 2 B</b>	5.2 V
R1511S053B	<b>S 5 3 B</b>	5.3 V
R1511S054B	<b>S 5 4 B</b>	5.4 V
R1511S055B	<b>S 5 5 B</b>	5.5 V
R1511S056B	<b>S 5 6 B</b>	5.6 V
R1511S057B	<b>S 5 7 B</b>	5.7 V
R1511S058B	<b>S 5 8 B</b>	5.8 V
R1511S059B	<b>S 5 9 B</b>	5.9 V
R1511S060B	<b>S 6 0 B</b>	6.0 V
R1511S061B	<b>S 6 1 B</b>	6.1 V
R1511S062B	<b>S 6 2 B</b>	6.2 V
R1511S063B	<b>S 6 3 B</b>	6.3 V
R1511S064B	<b>S 6 4 B</b>	6.4 V
R1511S065B	<b>S 6 5 B</b>	6.5 V
R1511S066B	<b>S 6 6 B</b>	6.6 V
R1511S067B	<b>S 6 7 B</b>	6.7 V
R1511S068B	<b>S 6 8 B</b>	6.8 V
R1511S069B	<b>S 6 9 B</b>	6.9 V
R1511S070B	<b>S 6 0 B</b>	7.0 V
R1511S071B	<b>S 7 1 B</b>	7.1 V
R1511S072B	<b>S 7 2 B</b>	7.2 V
R1511S073B	<b>S 7 3 B</b>	7.3 V
R1511S074B	<b>S 7 4 B</b>	7.4 V
R1511S075B	<b>S 7 5 B</b>	7.5 V
R1511S076B	<b>S 7 6 B</b>	7.6 V
R1511S077B	<b>S 7 7 B</b>	7.7 V
R1511S078B	<b>S 7 8 B</b>	7.8 V
R1511S079B	<b>S 7 9 B</b>	7.9 V
R1511S080B	<b>S 8 0 B</b>	8.0 V

Product Name	①②③④	V <sub>SET</sub>
R1511S081B	<b>S 8 1 B</b>	8.1 V
R1511S082B	<b>S 8 2 B</b>	8.2 V
R1511S083B	<b>S 8 3 B</b>	8.3 V
R1511S084B	<b>S 8 4 B</b>	8.4 V
R1511S085B	<b>S 8 5 B</b>	8.5 V
R1511S086B	<b>S 8 6 B</b>	8.6 V
R1511S087B	<b>S 8 7 B</b>	8.7 V
R1511S088B	<b>S 8 8 B</b>	8.8 V
R1511S089B	<b>S 8 9 B</b>	8.9 V
R1511S090B	<b>S 9 0 B</b>	9.1 V

### R1511S001C Mark Specification Table

Product Name	①②③④	V <sub>SET</sub>
R1511S001C	<b>S 0 0 C</b>	3.0 V

### Package Dimensions (TO-252-5-P2)

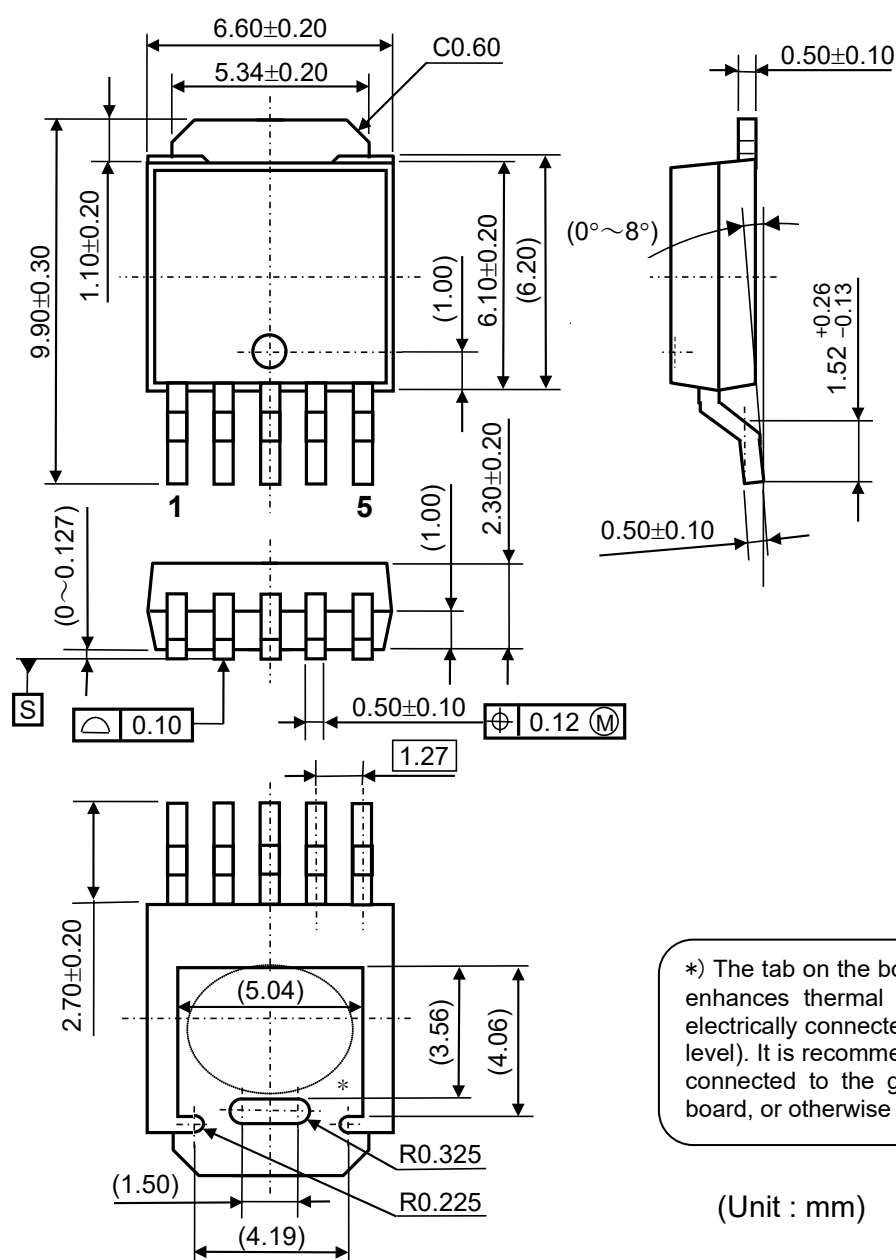

## Mark Specification (TO-252-5-P2)

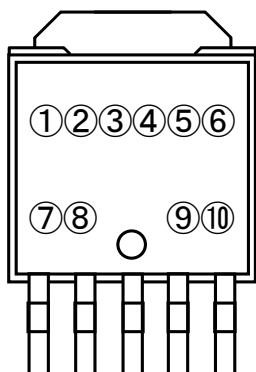

①②③④⑤⑥⑦⑧: Product Code ... Refer to R1511J Series Mark Specification Table

⑨⑩: Lot Number ... Alphanumeric Serial Number

### NOTICE

There can be variation in the marking when different AOI (Automated Optical Inspection) equipment is used. In the case of recognizing the marking characteristic with AOI, please contact our sales or distributor before attempting to use AOI.

## R1511J Series Mark Specification Table

PKG: TO-252-5-P2

R1511JxxxB Mark Specification Table

Product Name	①②③④⑤⑥⑦⑧	V <sub>SET</sub>
R1511J030B	H 1 J 0 3 0 B _	3.0 V
R1511J031B	H 1 J 0 3 1 B _	3.1 V
R1511J032B	H 1 J 0 3 2 B _	3.2 V
R1511J033B	H 1 J 0 3 3 B _	3.3 V
R1511J034B	H 1 J 0 3 4 B _	3.4 V
R1511J035B	H 1 J 0 3 5 B _	3.5 V
R1511J036B	H 1 J 0 3 6 B _	3.6 V
R1511J037B	H 1 J 0 3 7 B _	3.7 V
R1511J038B	H 1 J 0 3 8 B _	3.8 V
R1511J039B	H 1 J 0 3 9 B _	3.9 V
R1511J040B	H 1 J 0 4 0 B _	4.0 V
R1511J041B	H 1 J 0 4 1 B _	4.1 V
R1511J042B	H 1 J 0 4 2 B _	4.2 V
R1511J043B	H 1 J 0 4 3 B _	4.3 V
R1511J044B	H 1 J 0 4 4 B _	4.4 V
R1511J045B	H 1 J 0 4 5 B _	4.5 V
R1511J046B	H 1 J 0 4 6 B _	4.6 V
R1511J047B	H 1 J 0 4 7 B _	4.7 V
R1511J048B	H 1 J 0 4 8 B _	4.8 V
R1511J049B	H 1 J 0 4 9 B _	4.9 V
R1511J050B	H 1 J 0 5 0 B _	5.0 V
R1511J051B	H 1 J 0 5 1 B _	5.1 V
R1511J052B	H 1 J 0 5 2 B _	5.2 V
R1511J053B	H 1 J 0 5 3 B _	5.3 V
R1511J054B	H 1 J 0 5 4 B _	5.4 V
R1511J055B	H 1 J 0 5 5 B _	5.5 V
R1511J056B	H 1 J 0 5 6 B _	5.6 V
R1511J057B	H 1 J 0 5 7 B _	5.7 V
R1511J058B	H 1 J 0 5 8 B _	5.8 V
R1511J059B	H 1 J 0 5 9 B _	5.9 V
R1511J060B	H 1 J 0 6 0 B _	6.0 V
R1511J061B	H 1 J 0 6 1 B _	6.1 V
R1511J062B	H 1 J 0 6 2 B _	6.2 V
R1511J063B	H 1 J 0 6 3 B _	6.3 V
R1511J064B	H 1 J 0 6 4 B _	6.4 V
R1511J065B	H 1 J 0 6 5 B _	6.5 V
R1511J066B	H 1 J 0 6 6 B _	6.6 V
R1511J067B	H 1 J 0 6 7 B _	6.7 V
R1511J068B	H 1 J 0 6 8 B _	6.8 V
R1511J069B	H 1 J 0 6 9 B _	6.9 V
R1511J070B	H 1 J 0 7 0 B _	7.0 V
R1511J071B	H 1 J 0 7 1 B _	7.1 V
R1511J072B	H 1 J 0 7 2 B _	7.2 V
R1511J073B	H 1 J 0 7 3 B _	7.3 V
R1511J074B	H 1 J 0 7 4 B _	7.4 V
R1511J075B	H 1 J 0 7 5 B _	7.5 V
R1511J076B	H 1 J 0 7 6 B _	7.6 V
R1511J077B	H 1 J 0 7 7 B _	7.7 V
R1511J078B	H 1 J 0 7 8 B _	7.8 V
R1511J079B	H 1 J 0 7 9 B _	7.9 V
R1511J080B	H 1 J 0 8 0 B _	8.0 V

Product Name	①②③④⑤⑥⑦⑧	V <sub>SET</sub>
R1511J081B	H 1 J 0 8 1 B _	8.1 V
R1511J082B	H 1 J 0 8 2 B _	8.2 V
R1511J083B	H 1 J 0 8 3 B _	8.3 V
R1511J084B	H 1 J 0 8 4 B _	8.4 V
R1511J085B	H 1 J 0 8 5 B _	8.5 V
R1511J086B	H 1 J 0 8 6 B _	8.6 V
R1511J087B	H 1 J 0 8 7 B _	8.7 V
R1511J088B	H 1 J 0 8 8 B _	8.8 V
R1511J089B	H 1 J 0 8 9 B _	8.9 V
R1511J090B	H 1 J 0 9 0 B _	9.0 V

R1511J001C Mark Specification Table

Product Name	①②③④⑤⑥⑦⑧	V <sub>SET</sub>
R1511J001C	H 1 J 0 0 1 C _	3.0 V

**TEST CIRCUITS.**

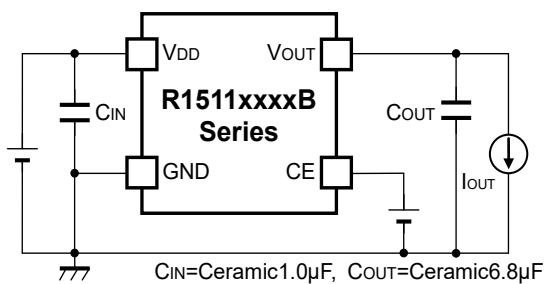

**R1511xxxxB Basic Test Circuit**

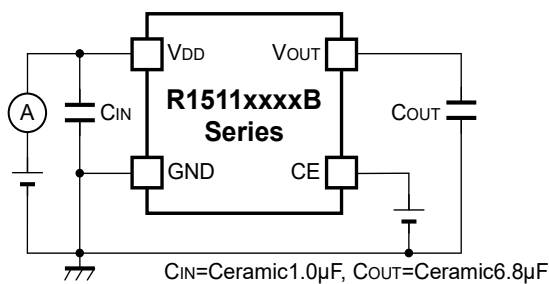

**R1511xxxxB Test Circuit for Supply Current**

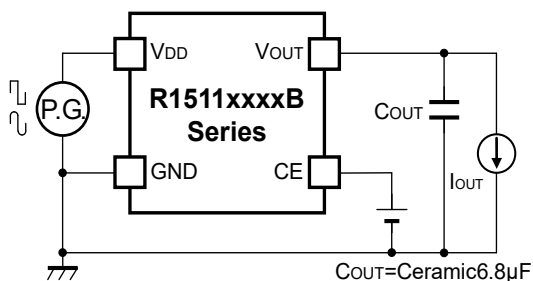

**R1511xxxxB Test Circuit for Ripple Rejection and Regulator Input Transient Response**

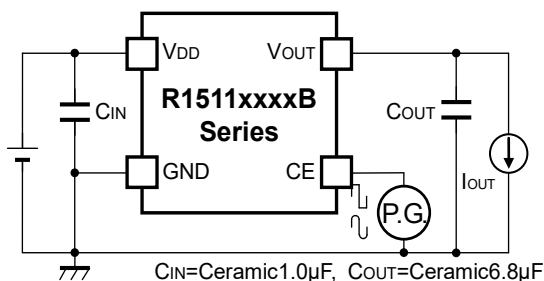

**R1511xxxxB Test Circuit for CE Start-up**

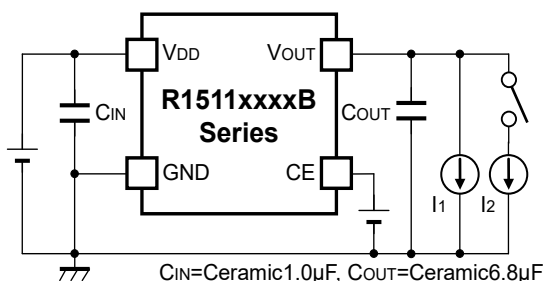

**R1511xxxxB Test Circuit for Load Transient Response**

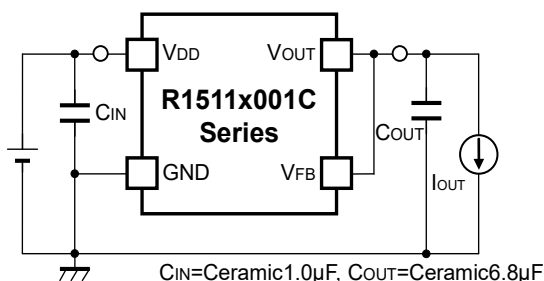

**R1511x001C Basic Test Circuit**

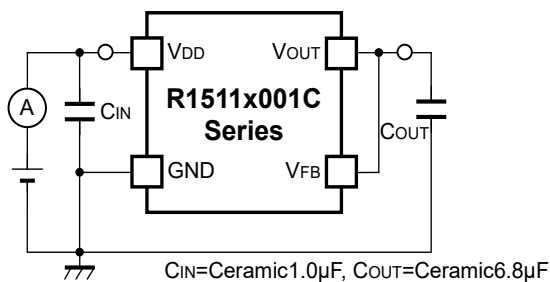

**R1511x001C Test Circuit for Supply Current**

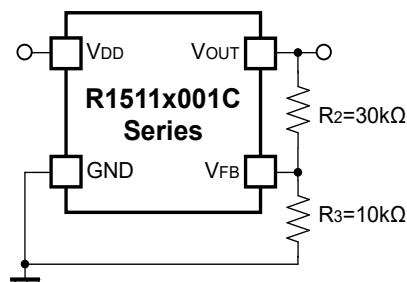

**R1511x001C Case of output voltage adjustment by external resistors**



## TYPICAL CHARACTERISTICS

### (1) Output Voltage Vs. Output Current (Ta=25°C)

R1511x030B

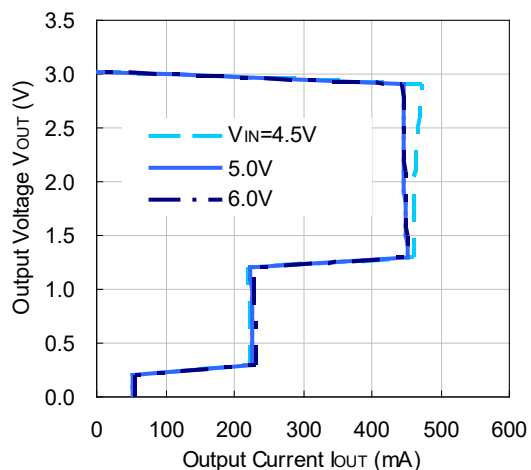

R1511x050B

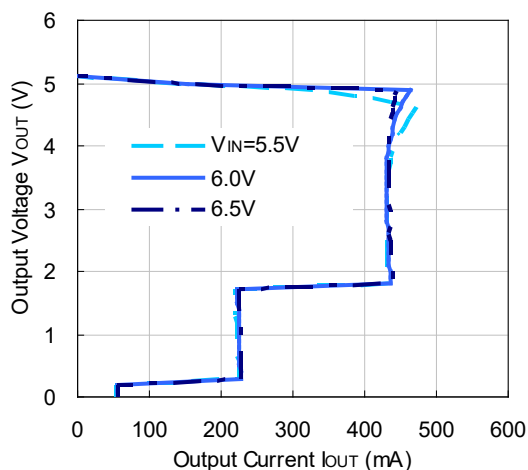

R1511x090B

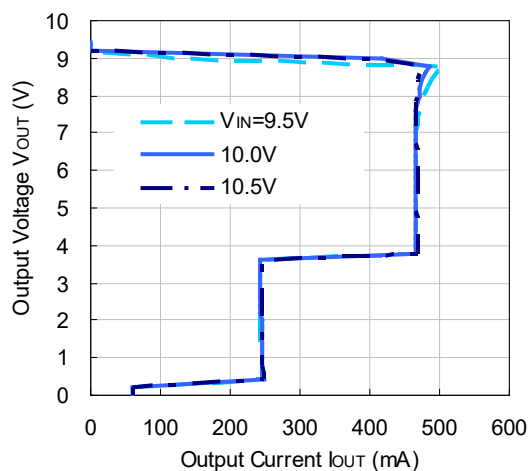

R1511x001C

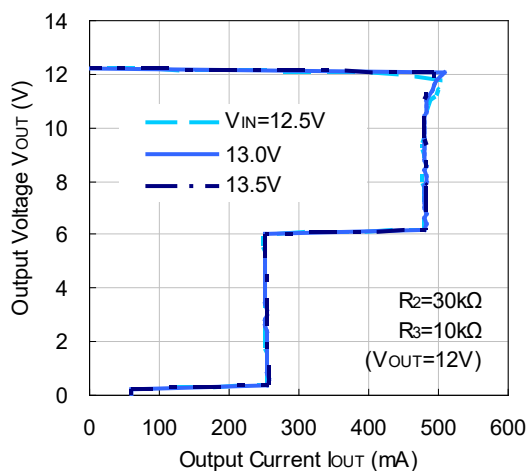

### 2) Output Voltage Vs. Input Voltage (Ta=25°C)

R1511x030B

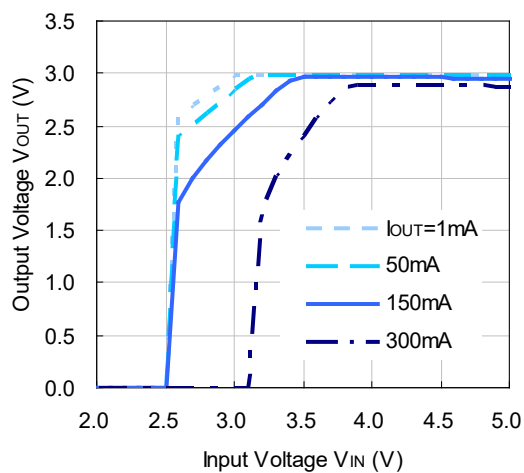

R1511x050B

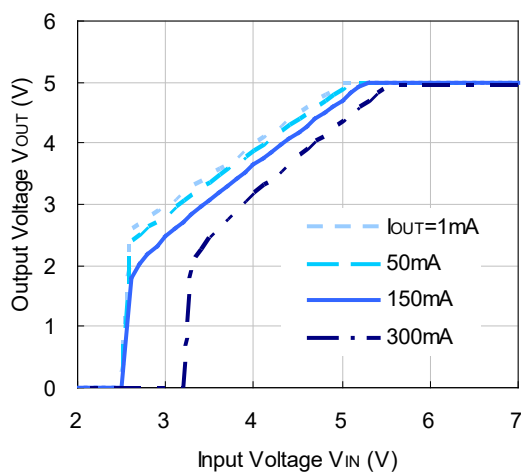

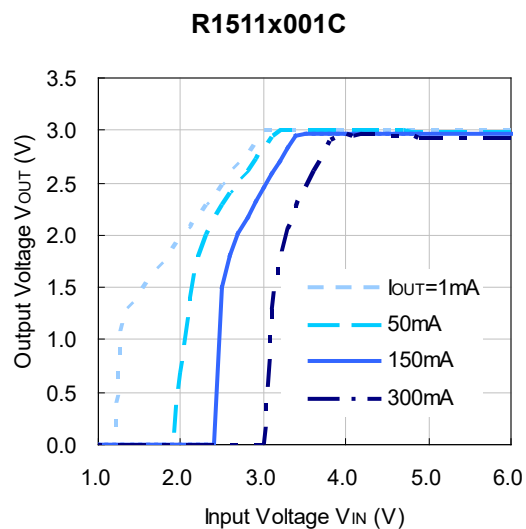
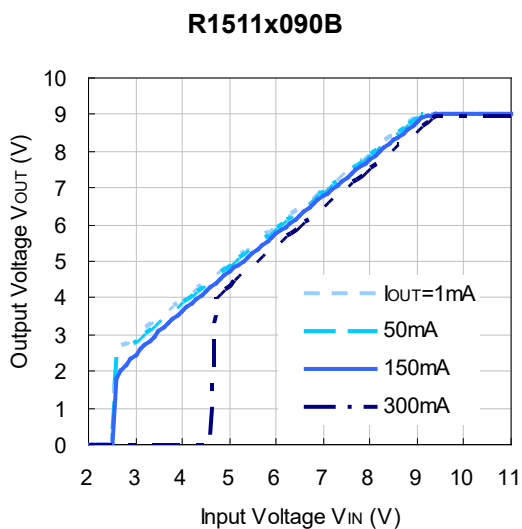

### 3) Supply Current Vs. Input Voltage

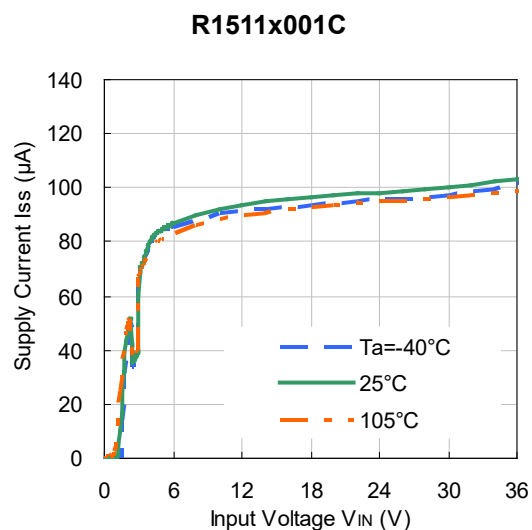
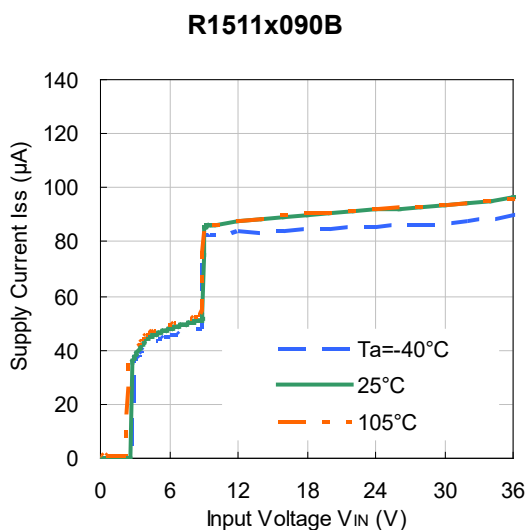
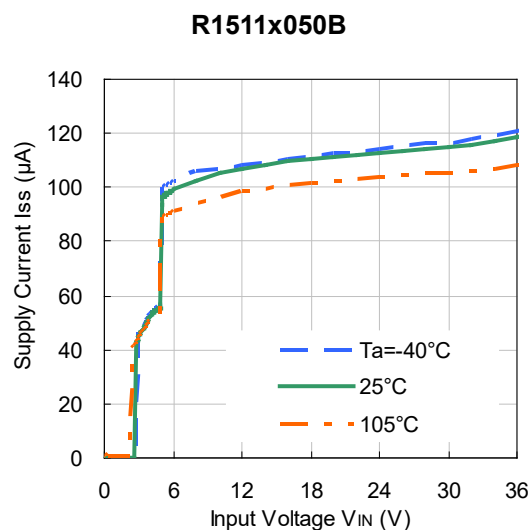
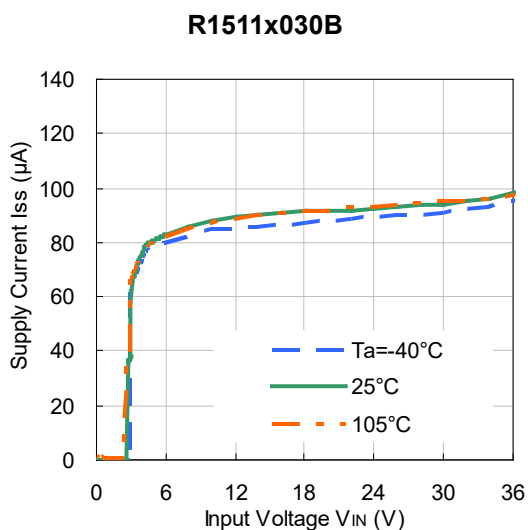

#### 4) Output Voltage Vs. Ambient Temperature

**R1511x030B**

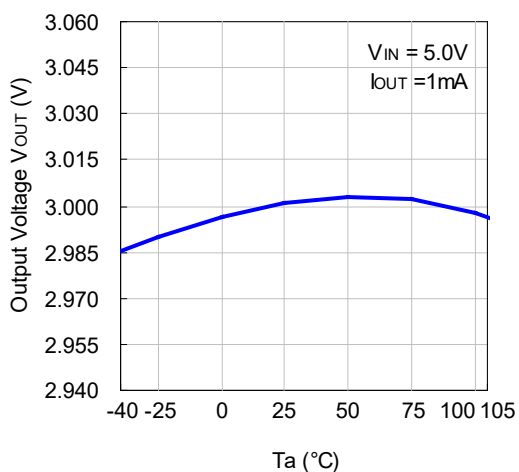

**R1511x050B**

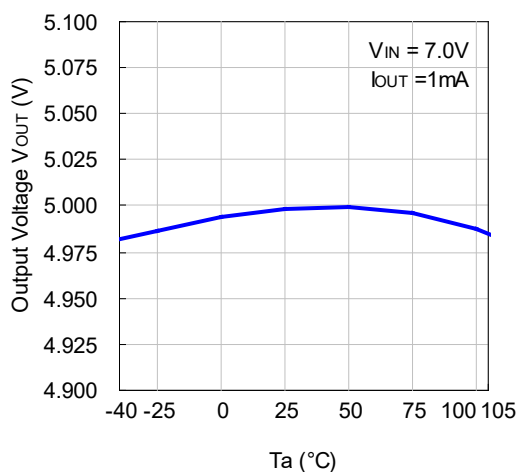

**R1511x090B**

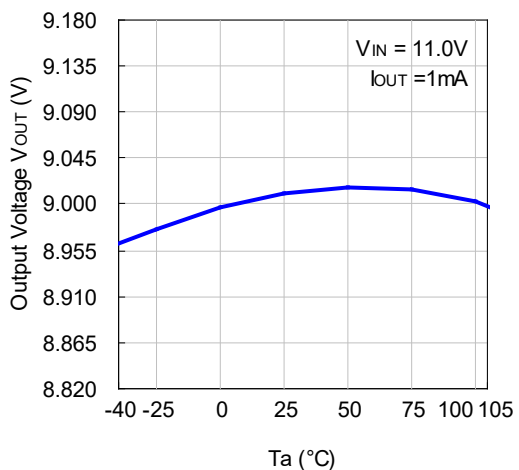

**R1511x001C**

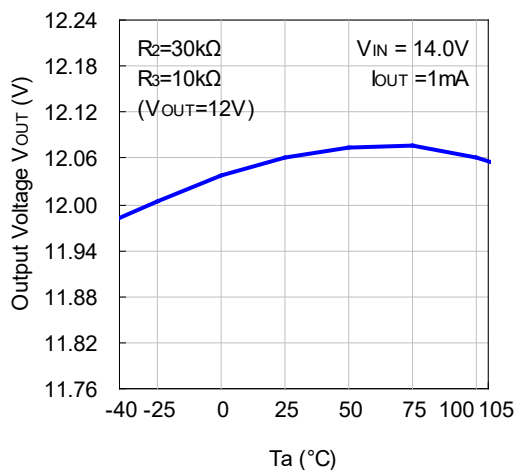

#### 5) Dropout Voltage Vs. Output Current

**R1511x030B/R1511x001C**

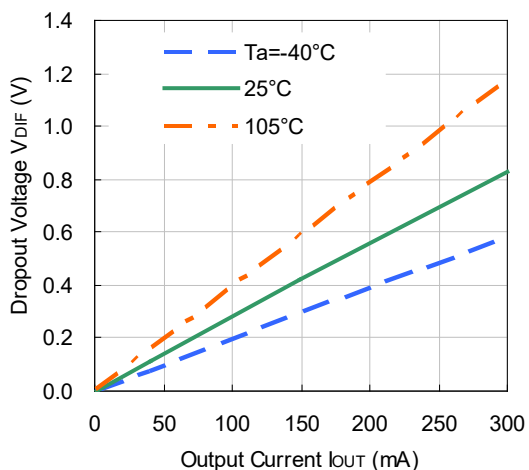

**R1511x050B**

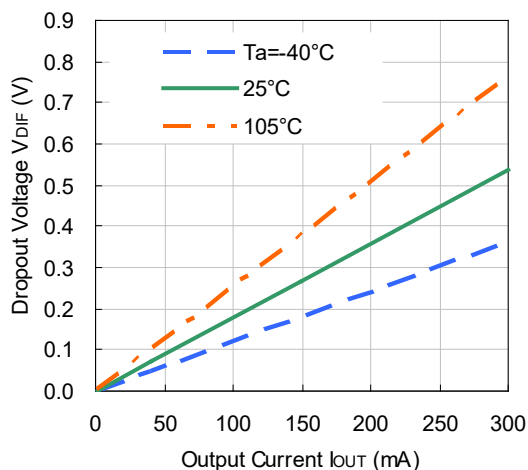

R1511x090B

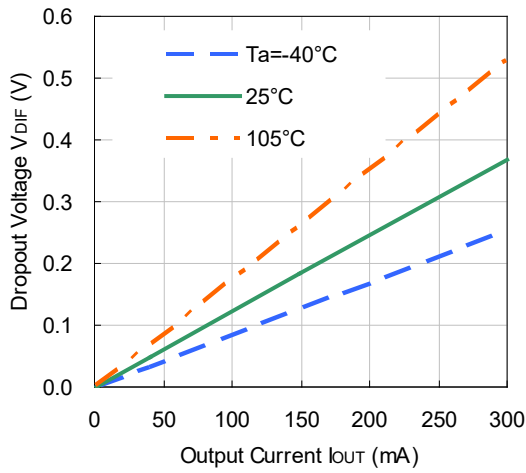

6) Dropout Voltage Vs. Setting Voltage ( $T_a=25^\circ\text{C}$ )

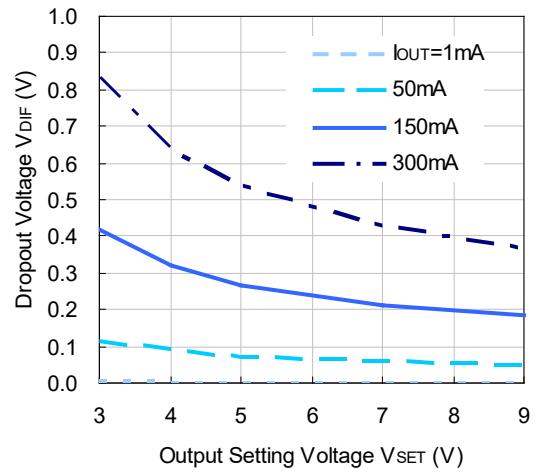

7) Ripple Rejection Vs. Input Bias Voltage ( $T_a=25^\circ\text{C}$ , Ripple=0.5V<sub>pp</sub>)

R1511x030B/R1511x001C ( $I_{OUT}=1\text{mA}$ )

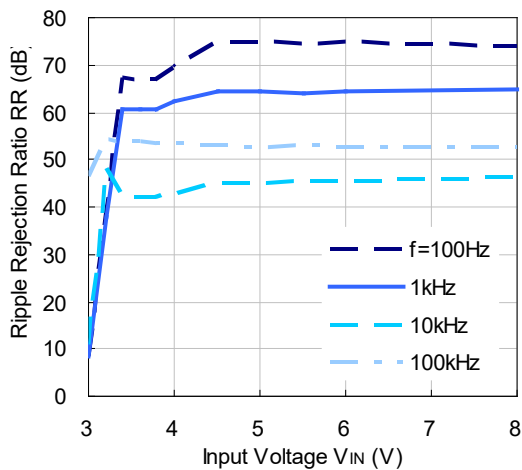

R1511x030B/R1511x001C ( $I_{OUT}=100\text{mA}$ )

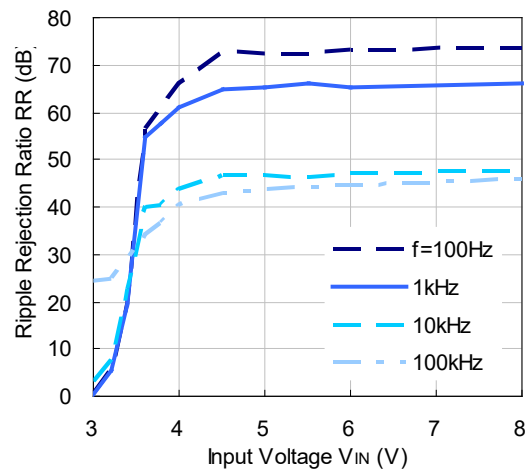

R1511x050B ( $I_{OUT}=1\text{mA}$ )

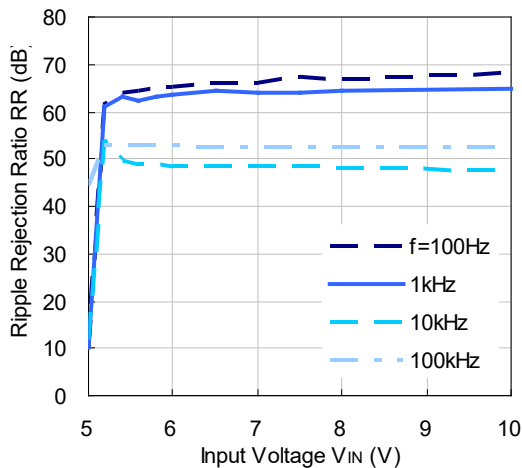

R1511x050B ( $I_{OUT}=100\text{mA}$ )

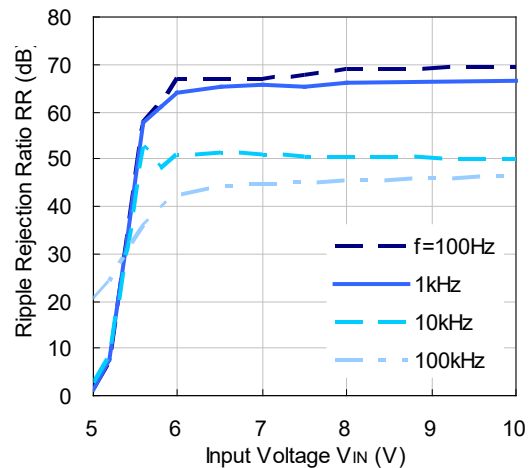

R1511x090B (I<sub>OUT</sub>=1mA)

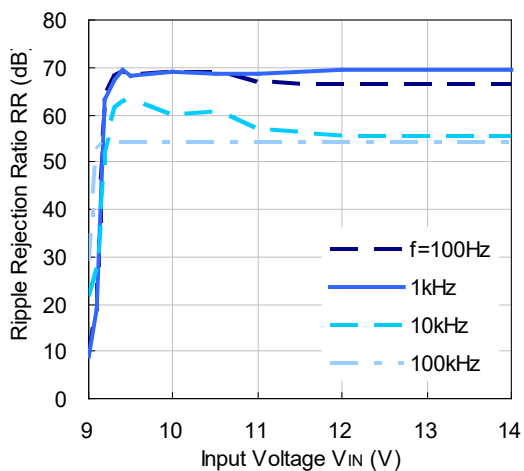

R1511x090B (I<sub>OUT</sub>=100mA)

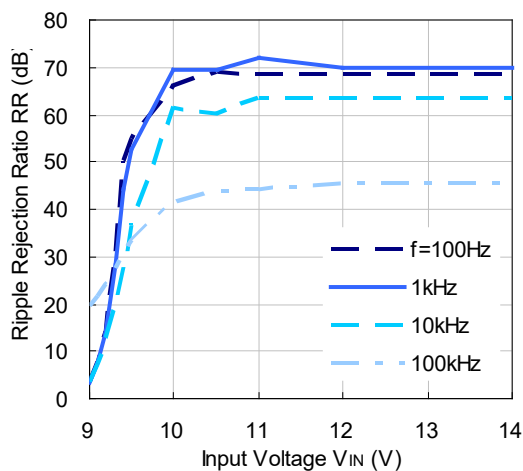

8) Ripple Rejection Vs. Frequency (Ta=25°C, Ripple=0.5V<sub>pp</sub>)

R1511x030B/R1511x001C

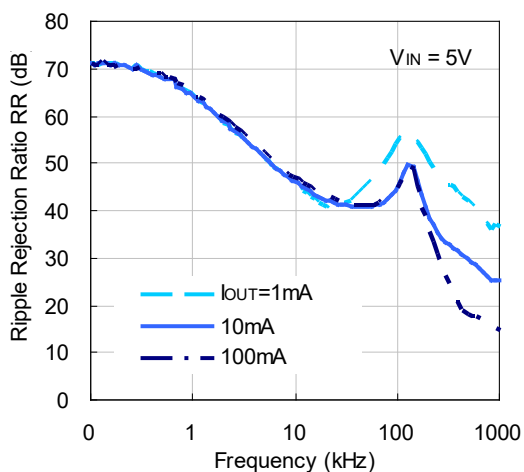

R1511x050B

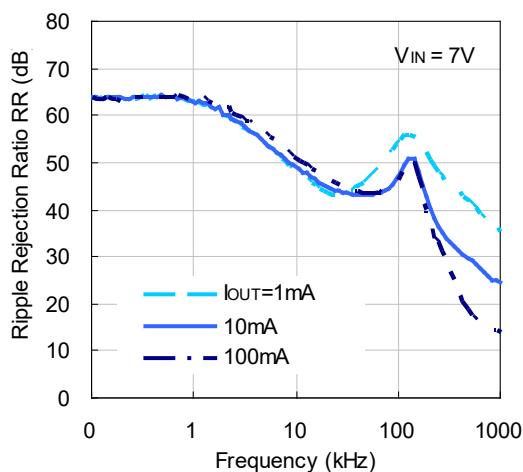

R1511x090B

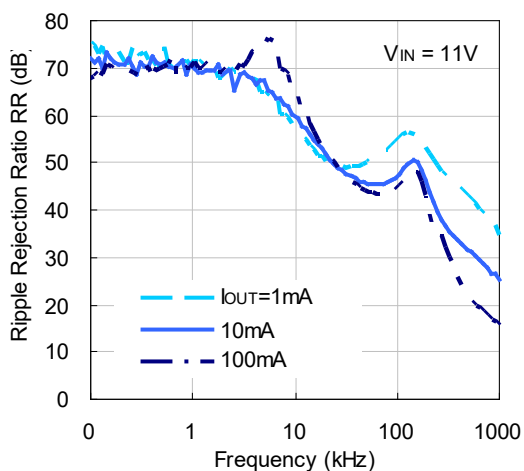

10) Input Transient Response (Ta=25°C)

R1511x030B

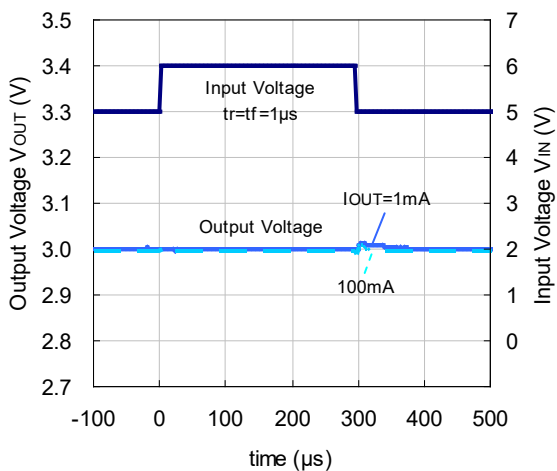

R1511x050B

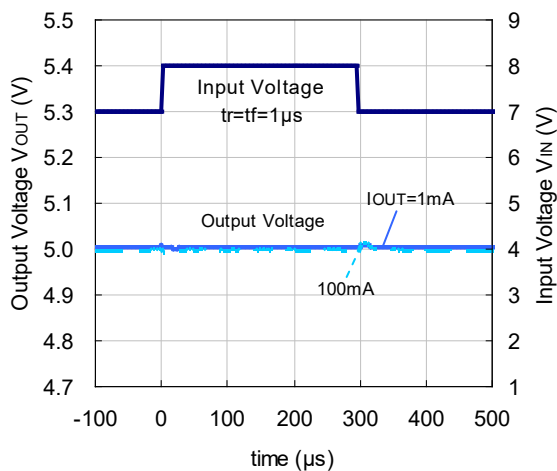

R1511x090B

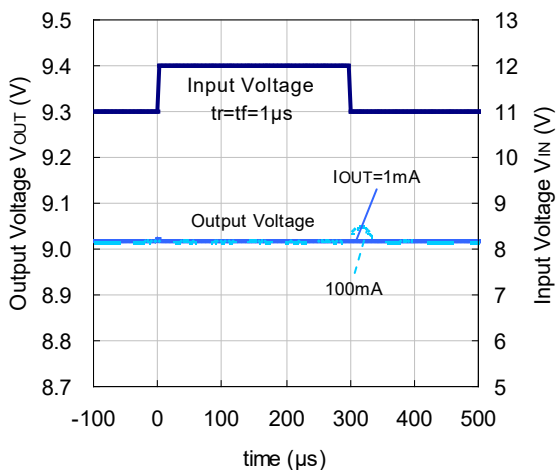

10) Load Transient Response (Ta=25°C)

R1511x030B

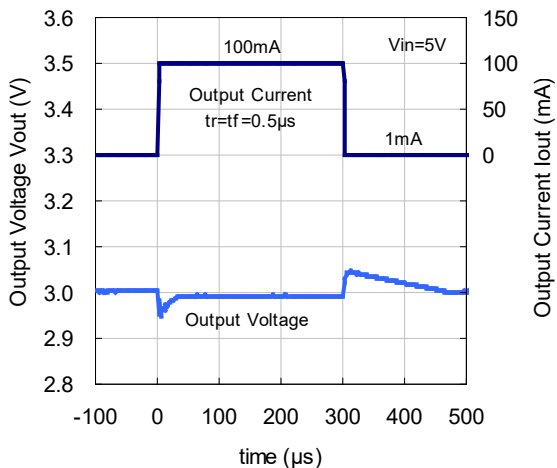

R1511x050B

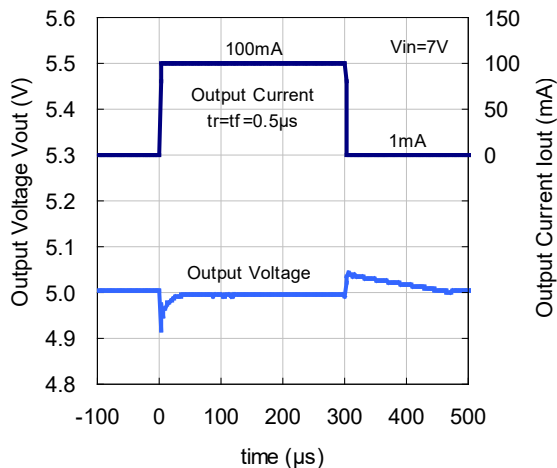

**R1511x090B**

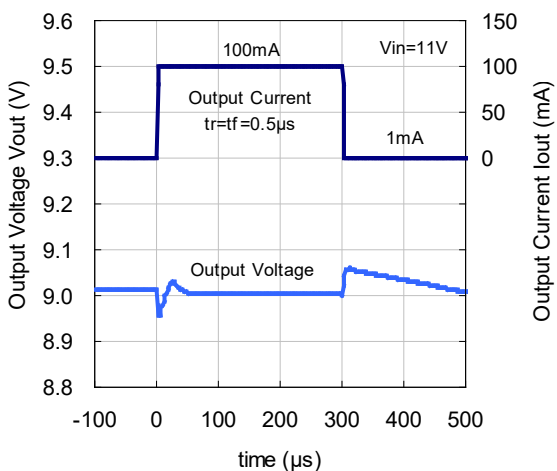

**11) CE Response ( $T_a=25^\circ C$ )**

**R1511x030B (Turn On)**

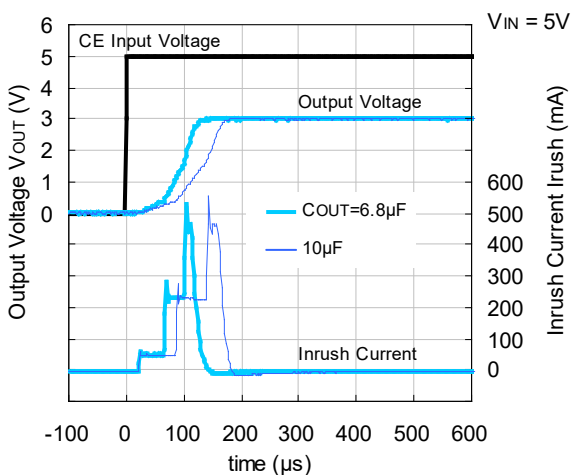

**R1511x030B (Turn Off)**

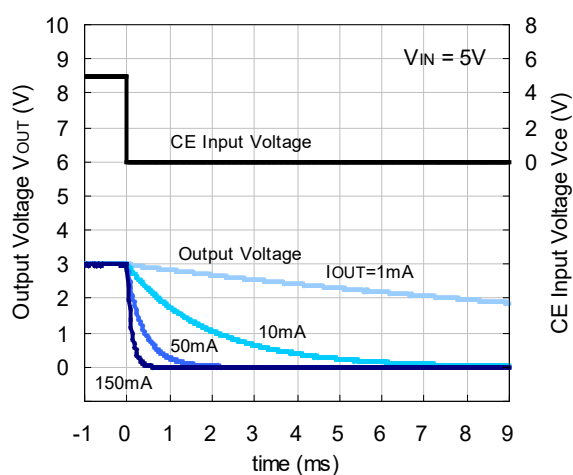

**R1511x050B (Turn On)**

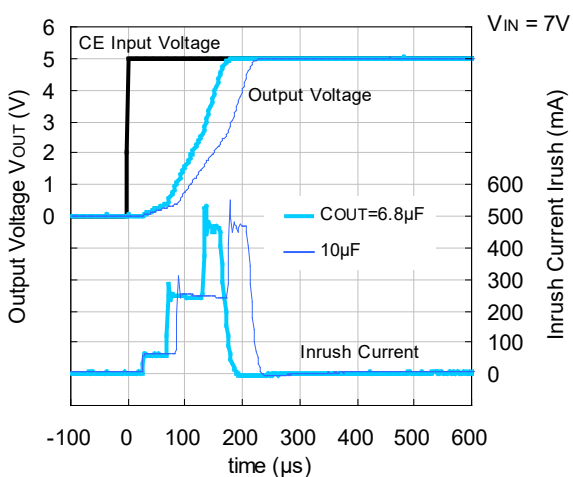

**R1511x050B (Turn Off)**

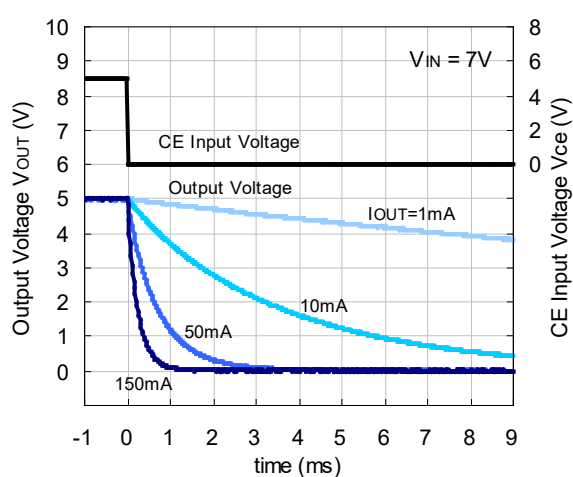

R1511x090B (Turn On)

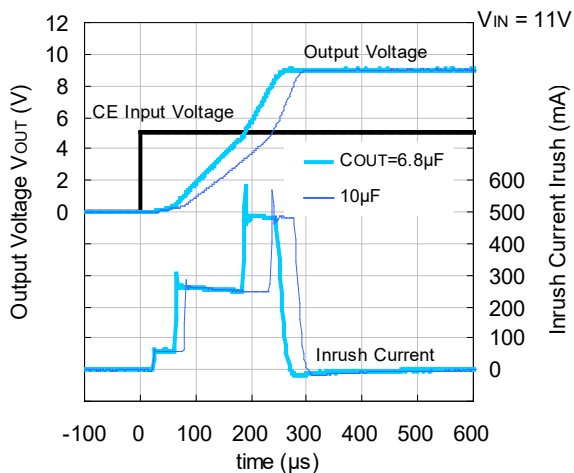

R1511x090B (Turn Off)

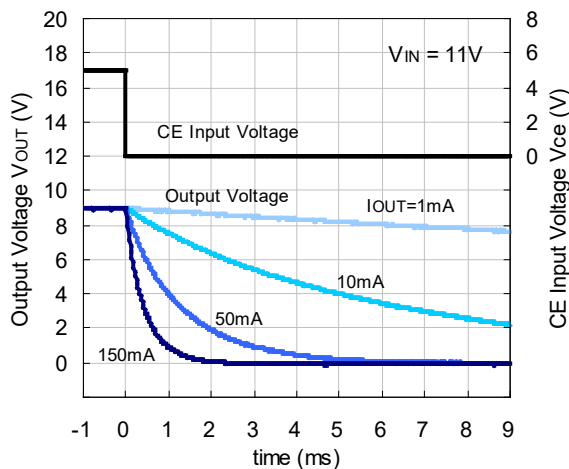

12) Start Up Waveform (Ta=25°C)

R1511x030B

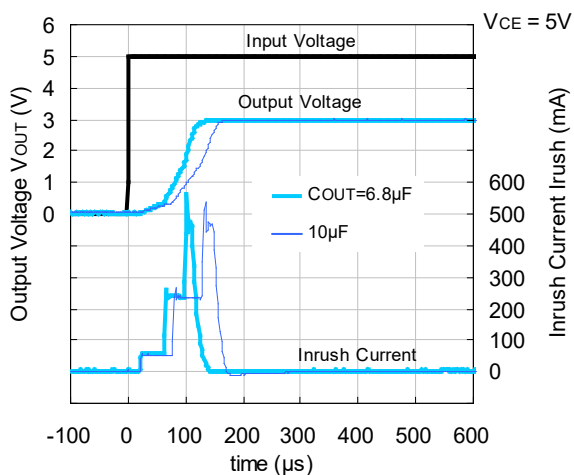

R1511x001C

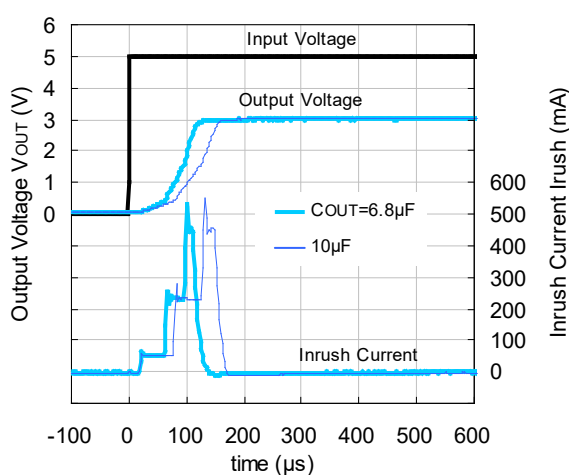

13) CE Pin Current Vs. CE Input Voltage

R1511xxxxB

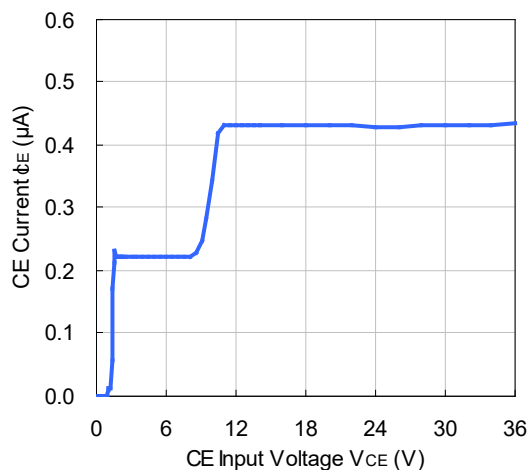



## EFFECTIVE SERIES RESISTANCE (ESR) VS. OUTPUT CURRENT

Ceramic type output capacitor is recommended for this series; however, the other output capacitors with low ESR also can be used. As for reference, the below graphs show the relationship between output current ( $I_{OUT}$ ) and effective series resistance (ESR). The noise level of the output current ( $I_{OUT}$ ) was measured by the test circuit and is lower than the specified value.

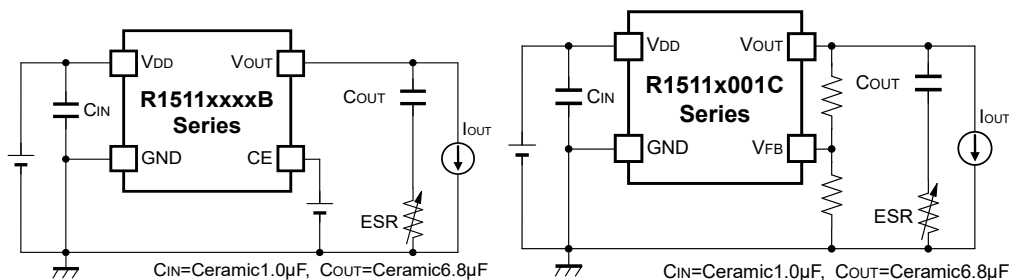

### Measurement Conditions

- Noise Frequency Range: 10Hz to 1MHz
- Ambient Temperature:  $-40^{\circ}\text{C}$  to  $105^{\circ}\text{C}$
- Shaded Area: Noise level is lower than the specified value ( $40\mu\text{V}$ )
- Capacitor:  $C_{IN}$ =Ceramic  $1.0\mu\text{F}$ ,  $C_{OUT}$ =Ceramic  $6.8\mu\text{F}$  (C4532X7S1H685K)

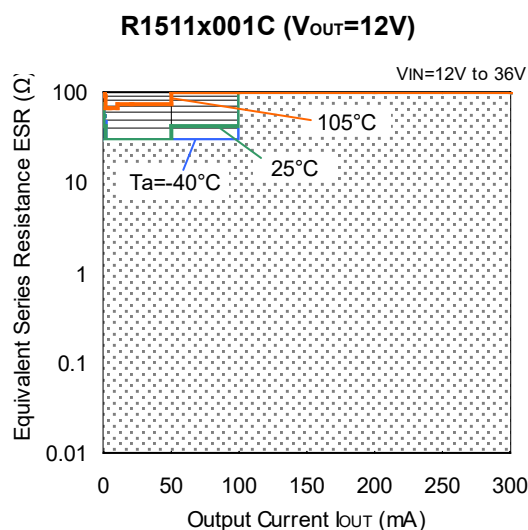
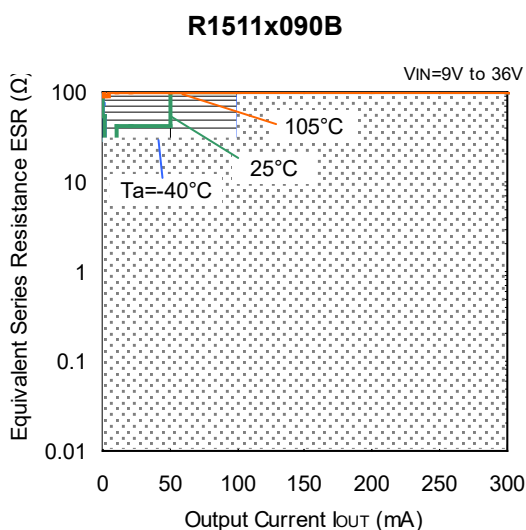
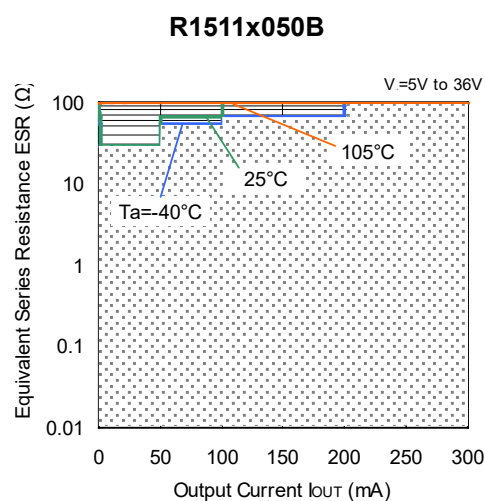
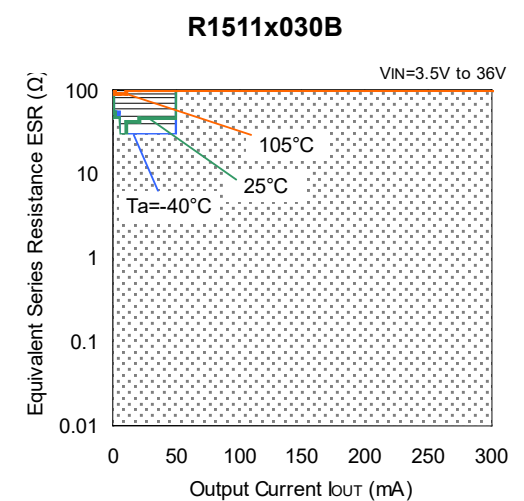

1. The products and the product specifications described in this document are subject to change or discontinuation of production without notice for reasons such as improvement. Therefore, before deciding to use the products, please refer to our sales representatives for the latest information thereon.
2. The materials in this document may not be copied or otherwise reproduced in whole or in part without the prior written consent of us.
3. This product and any technical information relating thereto are subject to complementary export controls (so-called KNOW controls) under the Foreign Exchange and Foreign Trade Law, and related politics ministerial ordinance of the law. (Note that the complementary export controls are inapplicable to any application-specific products, except rockets and pilotless aircraft, that are insusceptible to design or program changes.) Accordingly, when exporting or carrying abroad this product, follow the Foreign Exchange and Foreign Trade Control Law and its related regulations with respect to the complementary export controls.
4. The technical information described in this document shows typical characteristics and example application circuits for the products. The release of such information is not to be construed as a warranty of or a grant of license under our or any third party's intellectual property rights or any other rights.
5. The products listed in this document are intended and designed for use as general electronic components in standard applications (office equipment, telecommunication equipment, measuring instruments, consumer electronic products, amusement equipment etc.). Those customers intending to use a product in an application requiring extreme quality and reliability, for example, in a highly specific application where the failure or misoperation of the product could result in human injury or death should first contact us.
  - Aerospace Equipment
  - Equipment Used in the Deep Sea
  - Power Generator Control Equipment (nuclear, steam, hydraulic, etc.)
  - Life Maintenance Medical Equipment
  - Fire Alarms / Intruder Detectors
  - Vehicle Control Equipment (automotive, airplane, railroad, ship, etc.)
  - Various Safety Devices
  - Traffic control system
  - Combustion equipment

In case your company desires to use this product for any applications other than general electronic equipment mentioned above, make sure to contact our company in advance. Note that the important requirements mentioned in this section are not applicable to cases where operation requirements such as application conditions are confirmed by our company in writing after consultation with your company.

6. We are making our continuous effort to improve the quality and reliability of our products, but semiconductor products are likely to fail with certain probability. In order to prevent any injury to persons or damages to property resulting from such failure, customers should be careful enough to incorporate safety measures in their design, such as redundancy feature, fire containment feature and fail-safe feature. We do not assume any liability or responsibility for any loss or damage arising from misuse or inappropriate use of the products.
7. The products have been designed and tested to function within controlled environmental conditions. Do not use products under conditions that deviate from methods or applications specified in this datasheet. Failure to employ the products in the proper applications can lead to deterioration, destruction or failure of the products. We shall not be responsible for any bodily injury, fires or accident, property damage or any consequential damages resulting from misuse or misapplication of the products.
8. **Quality Warranty**
  - 8-1. **Quality Warranty Period**

In the case of a product purchased through an authorized distributor or directly from us, the warranty period for this product shall be one (1) year after delivery to your company. For defective products that occurred during this period, we will take the quality warranty measures described in section 8-2. However, if there is an agreement on the warranty period in the basic transaction agreement, quality assurance agreement, delivery specifications, etc., it shall be followed.
  - 8-2. **Quality Warranty Remedies**

When it has been proved defective due to manufacturing factors as a result of defect analysis by us, we will either deliver a substitute for the defective product or refund the purchase price of the defective product.

Note that such delivery or refund is sole and exclusive remedies to your company for the defective product.
  - 8-3. **Remedies after Quality Warranty Period**

With respect to any defect of this product found after the quality warranty period, the defect will be analyzed by us. On the basis of the defect analysis results, the scope and amounts of damage shall be determined by mutual agreement of both parties. Then we will deal with upper limit in Section 8-2. This provision is not intended to limit any legal rights of your company.
9. Anti-radiation design is not implemented in the products described in this document.
10. The X-ray exposure can influence functions and characteristics of the products. Confirm the product functions and characteristics in the evaluation stage.
11. WLCSP products should be used in light shielded environments. The light exposure can influence functions and characteristics of the products under operation or storage.
12. Warning for handling Gallium and Arsenic (GaAs) products (Applying to GaAs MMIC, Photo Reflector). These products use Gallium (Ga) and Arsenic (As) which are specified as poisonous chemicals by law. For the prevention of a hazard, do not burn, destroy, or process chemically to make them as gas or power. When the product is disposed of, please follow the related regulation and do not mix this with general industrial waste or household waste.
13. Please contact our sales representatives should you have any questions or comments concerning the products or the technical information.



**Nisshinbo Micro Devices Inc.**

**Official website**

<https://www.nisshinbo-microdevices.co.jp/en/>

**Purchase information**

<https://www.nisshinbo-microdevices.co.jp/en/buy/>

## X-ON Electronics

Largest Supplier of Electrical and Electronic Components

*Click to view similar products for [LDO Voltage Regulators](#) category:*

*Click to view products by [Nisshinbo](#) manufacturer:*

Other Similar products are found below :

[AP7363-SP-13](#) [NCV8664CST33T3G](#) [L79M05TL-E](#) [AP7362-HA-7](#) [PT7M8202B12TA5EX](#) [TCR3DF185,LM\(CT](#) [TLF4949EJ](#)  
[NCP4687DH15T1G](#) [NCV8703MX30TCG](#) [LP2951CN](#) [NCV4269CPD50R2G](#) [AP7315-25W5-7](#) [NCV47411PAAJR2G](#) [AP2111H-1.2TRG1](#)  
[ZLDO1117QK50TC](#) [AZ1117ID-ADJTRG1](#) [NCV4263-2CPD50R2G](#) [NCP706ABMX300TAG](#) [NCP114BMX075TCG](#) [MC33269T-3.5G](#)  
[TLE4471GXT](#) [AP7315-33SA-7](#) [NCV4266-2CST33T3G](#) [NCP715SQ15T2G](#) [NCV8623MN-50R2G](#) [NCV563SQ18T1G](#) [NCV8664CDT33RKG](#)  
[NCV4299CD250R2G](#) [NCP715MX30TBG](#) [NCV8702MX25TCG](#) [TLE7270-2E](#) [NCV562SQ25T1G](#) [AP2213D-3.3TRG1](#) [AP2202K-2.6TRE1](#)  
[NCV8170BMX300TCG](#) [NCV8152MX300180TCG](#) [NCP700CMT45TBG](#) [AP7315-33W5-7](#) [NCP154MX180300TAG](#) [AP2113AMTR-G1](#)  
[NJW4104U2-33A-TE1](#) [MP2013AGG-5-P](#) [NCV8775CDT50RKG](#) [NJM2878F3-45-TE1](#) [S-19214B00A-V5T2U7](#) [S-19214B50A-V5T2U7](#) [S-](#)  
[19213B50A-V5T2U7](#) [S-19214BC0A-E8T1U7\\*1](#) [S-19213B00A-V5T2U7](#) [S-19213B33A-V5T2U7](#)