LOW VOLTAGE DETECTOR WITH OUTPUT DELAY

NO. EA-087-160310

OUTLINE

The R3112x Series are CMOS-based voltage detector ICs with high detector threshold accuracy and ultra-low supply current, which can be operated at an extremely low voltage and is used for system reset as an example.

Each of these ICs consists of a voltage reference unit, a comparator, resistor net for detector threshold setting, an output driver, a hysteresis circuit, and an output delay circuit. The detector threshold is fixed with high accuracy internally and does not require any adjustment. Two output types, Nch open drain type and CMOS type are available.

Three types of packages, SOT-23-5, small SC-82AB, SC-88A and ultra-small SON1612-6 can be selected so that high density mounting on boards is possible.

FEATURES

- Built-in Output Delay Circuit..... Typ. 100ms with an external capacitor: 0.022 μ F
- Supply Current Typ. 0.5 μ A (R3112x27xA/C, V_{DD} =2.6V)
- Operating Voltage 0.7 to 6.0V (T_{opt} =25°C)
- Detector Threshold..... 0.9V to 5.0V (0.1V steps)
- Detector Threshold Accuracy \pm 2.0%
- Temperature-Drift Coefficient of Detector Threshold Typ. \pm 100ppm/°C
- Output Types..... Nch Open Drain and CMOS
- Packages SON1612-6, SC-82AB, SC-88A, SOT-23-5

APPLICATIONS

- CPU and Logic Circuit Reset
- Battery Checker
- Window Comparator
- Wave Shaping Circuit
- Battery Back-up Circuit
- Power Failure Detector

R3112x

BLOCK DIAGRAMS

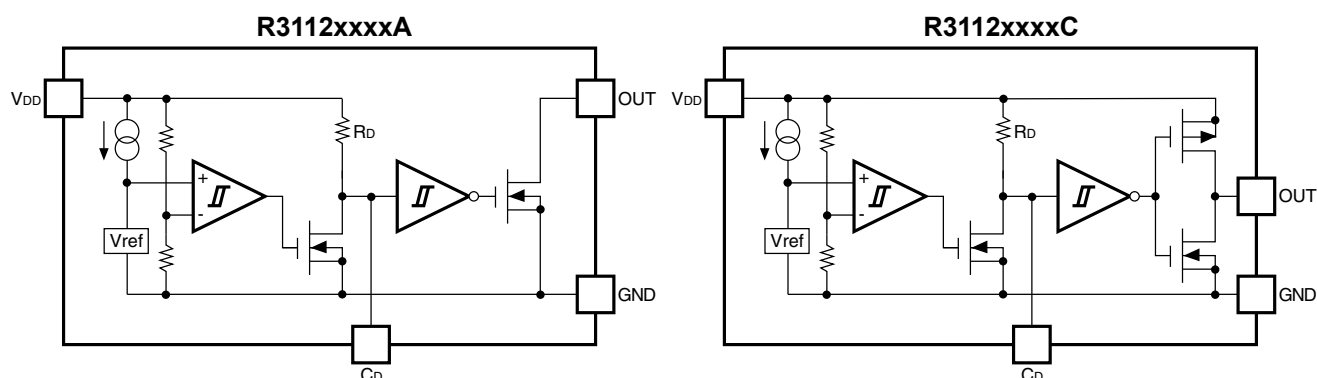

SELECTION GUIDE

The package type, the detector threshold, and the output type for the ICs can be selected at the users' request.

Product Name	Package	Quantity per Reel	Pb Free	Halogen Free
R3112Dxx1*-TR-FE	SON1612-6	4,000 pcs	Yes	Yes
R3112Qxx1*-TR-FE	SC-82AB	3,000 pcs	Yes	Yes
R3112Qxx2*-TR-FE	SC-88A	3,000 pcs	Yes	Yes
R3112Nxx1*-TR-FE	SOT-23-5	3,000 pcs	Yes	Yes

xx: The detector threshold can be designated in the range from 0.9V(09) to 5.0V(50) in 0.1V steps.

* : Designation of Output Type
 (A) Nch Open Drain
 (C) CMOS

PIN CONFIGURATION

● SON1612-6

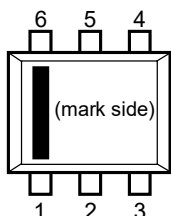

● SC-82AB

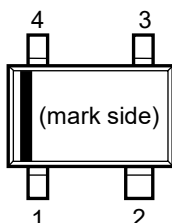

● SC-88A

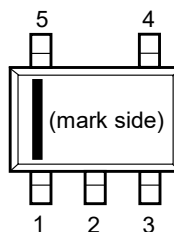

● SOT-23-5

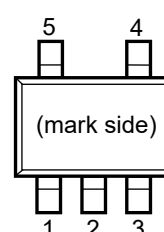

PIN DESCRIPTION

● SON1612-6

Pin No	Symbol	Pin Description
1	OUT	Output Pin (Output "L" at detection)
2	GND	Ground Pin
3	C _D	Pin for External Capacitor (for setting output delay)
4	NC	No Connection
5	GND	Ground Pin
6	V _{DD}	Voltage Supply Pin

● SC-82AB

Pin No	Symbol	Pin Description
1	V _{DD}	Voltage Supply Pin
2	GND	Ground Pin
3	C _D	Pin for External Capacitor (for setting output delay)
4	OUT	Output Pin (Output "L" at detection)

● SC-88A

Pin No	Symbol	Pin Description
1	V _{DD}	Voltage Supply Pin
2	NC	No Connection
3	GND	Ground Pin
4	C _D	Pin for External Capacitor (for setting output delay)
5	OUT	Output Pin (Output "L" at detection)

● SOT-23-5

Pin No	Symbol	Pin Description
1	OUT	Output Pin (Output "L" at detection)
2	V _{DD}	Voltage Supply Pin
3	GND	Ground Pin
4	NC	No Connection
5	C _D	Pin for External Capacitor (for setting output delay)

R3112x

ABSOLUTE MAXIMUM RATINGS

Symbol	Item	Rating	Unit
V _{DD}	Supply Voltage	6.5	V
V _{OUT}	Output Voltage (CMOS)	V _{SS} -0.3 to V _{DD} +0.3	V
	Output Voltage (Nch)	V _{SS} -0.3 to 6.5	V
I _{OUT}	Output Current	20	mA
P _D	Power Dissipation (SON1612-6)*	500	mW
	Power Dissipation (SC-82AB)*	380	
	Power Dissipation (SC-88A)*	380	
	Power Dissipation (SOT-23-5)*	420	
T _{opt}	Operating Temperature Range	-40 to 85	°C
T _{stg}	Storage Temperature Range	-55 to 125	°C

*) For Power Dissipation, please refer to PACKAGE INFORMATION.

ABSOLUTE MAXIMUM RATINGS

Electronic and mechanical stress momentarily exceeded absolute maximum ratings may cause the permanent damages and may degrade the life time and safety for both device and system using the device in the field.

The functional operation at or over these absolute maximum ratings is not assured.

RECOMMENDED OPERATING CONDITIONS (ELECTRICAL CHARACTERISTICS)

All of electronic equipment should be designed that the mounted semiconductor devices operate within the recommended operating conditions. The semiconductor devices cannot operate normally over the recommended operating conditions, even if when they are used over such conditions by momentary electronic noise or surge. And the semiconductor devices may receive serious damage when they continue to operate over the recommended operating conditions.

ELECTRICAL CHARACTERISTICS

• R3112xxxxA/C

T_{opt}=25°C

Symbol	Item	Conditions	Min.	Typ.	Max.	Unit	
-V _{DET}	Detector Threshold		-V _{DET} ×0.98		-V _{DET} ×1.02	V	
V _{HYS}	Detector Threshold Hysteresis		-V _{DET} ×0.03	-V _{DET} ×0.05	-V _{DET} ×0.07	V	
I _{SS}	Supply Current	-V _{DET} <1.1V	V _{DD} =-V _{DET} -0.1V		0.6	2.0	μA
			V _{DD} =-V _{DET} +1.0V		0.5	2.0	
		1.1V ≤ -V _{DET} <1.6V	V _{DD} =-V _{DET} -0.1V		0.7	2.5	
			V _{DD} =-V _{DET} +1.0V		0.5	2.0	
		1.6V ≤ -V _{DET} <3.1V	V _{DD} =-V _{DET} -0.1V		1.0	3.0	
			V _{DD} =-V _{DET} +1.0V		0.5	2.5	
		3.1V ≤ -V _{DET} <4.1V	V _{DD} =-V _{DET} -0.1V		1.2	3.0	
			V _{DD} =-V _{DET} +1.0V		0.6	2.5	
4.1V ≤ -V _{DET}	V _{DD} =-V _{DET} -0.1V		1.5	3.0			
	V _{DD} =-V _{DET} +1.0V		0.6	2.5			
V _{DDH}	Maximum Operating Voltage				6.0	V	
V _{DDL}	Minimum Operating Voltage*	T _{opt} =25°C			0.7	V	
		-40°C ≤ T _{opt} ≤ 85°C			0.8		
I _{OUT}	Output Current (Driver Output Pin)	Nch	V _{DS} =0.05V V _{DD} =0.7V	0.01	0.12	mA	
			-V _{DET} <1.1V	V _{DS} =0.50V V _{DD} =0.85V	0.05		0.9
			1.1V ≤ -V _{DET} <1.6V	V _{DS} =0.50V V _{DD} =1.00V	0.2		1.8
			1.6V ≤ -V _{DET}	V _{DS} =0.50V V _{DD} =1.50V	1.0		3.0
		Pch	-V _{DET} <4.0V	V _{DS} =-2.1V V _{DD} =4.50V	1.5	3.5	mA
			4.0V ≤ -V _{DET}	V _{DS} =-2.1V V _{DD} =6.00V	2.0	4.5	
V _{TCD}	C _D pin Threshold Voltage	V _{DD} =-V _{DET} ×1.1V	V _{DD} ×0.3	V _{DD} ×0.5	V _{DD} ×0.7	V	
I _{CD}	C _D pin Output Current	V _{DS} =0.1V, V _{DD} =0.7V		20	70	μA	
		-V _{DET} <1.1V	V _{DS} =0.50V, V _{DD} =0.85V	10	400		
		1.1V ≤ -V _{DET} <1.6V	V _{DS} =0.50V, V _{DD} =1.00V	50	450		
		1.6V ≤ -V _{DET}	V _{DS} =0.50V, V _{DD} =1.50V	200	500		
R _D	Output Delay Resistance		3.25	6.5	13	MΩ	
Δ-V _{DET} / ΔT _{opt}	Detector Threshold Temperature Coefficient	-40°C ≤ T _{opt} ≤ 85°C		±100		ppm/ °C	

*) Minimum Operating Voltage means the value of input voltage when output voltage maintains 0.1V or less.
(In the case of Nch Open Drain Type, Output pin is pulled up with a resistance of 470kΩ to 5.0V.)

R3112x

ELECTRICAL CHARACTERISTICS BY DETECTOR THRESHOLD

Product Code	Detector Threshold			Hysteresis Range			Supply Current 1			Supply Current 2			Output Current 1			Output Current 2		
	-VDET[V]			VHYS[V]			Iss1[μA]			Iss2[μA]			Iout1[mA]			Iout2[mA]		
	Min.	Typ.	Max.	Min.	Typ.	Max.	Condi-tions	Typ.	Max.	Condi-tions	Typ.	Max.	Condi-tions	Min.	Typ.	Condi-tions	Min.	Typ.
R3112x09xA/C	0.882	0.900	0.918	0.027	0.045	0.063	VDD=-VDET -0.1V	0.6	2.0	0.5	2.0	VDS=0.05V VDD=0.7V	0.01	0.12	Nch	VDS=0.5V VDD=0.85V	0.05	0.9
R3112x10xA/C	0.980	1.000	1.020	0.030	0.050	0.070												
R3112x11xA/C	1.078	1.100	1.122	0.033	0.055	0.077												
R3112x12xA/C	1.176	1.200	1.224	0.036	0.060	0.084												
R3112x13xA/C	1.274	1.300	1.326	0.039	0.065	0.091												
R3112x14xA/C	1.372	1.400	1.428	0.042	0.070	0.098												
R3112x15xA/C	1.470	1.500	1.530	0.045	0.075	0.105												
R3112x16xA/C	1.568	1.600	1.632	0.048	0.080	0.112												
R3112x17xA/C	1.666	1.700	1.734	0.051	0.085	0.119												
R3112x18xA/C	1.764	1.800	1.836	0.054	0.090	0.126												
R3112x19xA/C	1.862	1.900	1.938	0.057	0.095	0.133												
R3112x20xA/C	1.960	2.000	2.040	0.060	0.100	0.140												
R3112x21xA/C	2.058	2.100	2.142	0.063	0.105	0.147												
R3112x22xA/C	2.156	2.200	2.244	0.066	0.110	0.154												
R3112x23xA/C	2.254	2.300	2.346	0.069	0.115	0.161												
R3112x24xA/C	2.352	2.400	2.448	0.072	0.120	0.168												
R3112x25xA/C	2.450	2.500	2.550	0.075	0.125	0.175												
R3112x26xA/C	2.548	2.600	2.652	0.078	0.130	0.182												
R3112x27xA/C	2.646	2.700	2.754	0.081	0.135	0.189												
R3112x28xA/C	2.744	2.800	2.856	0.084	0.140	0.196												
R3112x29xA/C	2.842	2.900	2.958	0.087	0.145	0.203												
R3112x30xA/C	2.940	3.000	3.060	0.090	0.150	0.210												
R3112x31xA/C	3.038	3.100	3.162	0.093	0.155	0.217												
R3112x32xA/C	3.136	3.200	3.264	0.096	0.160	0.224												
R3112x33xA/C	3.234	3.300	3.366	0.099	0.165	0.231												
R3112x34xA/C	3.332	3.400	3.468	0.102	0.170	0.238												
R3112x35xA/C	3.430	3.500	3.570	0.105	0.175	0.245												
R3112x36xA/C	3.528	3.600	3.672	0.108	0.180	0.252												
R3112x37xA/C	3.626	3.700	3.774	0.111	0.185	0.259												
R3112x38xA/C	3.724	3.800	3.876	0.114	0.190	0.266												
R3112x39xA/C	3.822	3.900	3.978	0.117	0.195	0.273												
R3112x40xA/C	3.920	4.000	4.080	0.120	0.200	0.280												
R3112x41xA/C	4.018	4.100	4.182	0.123	0.205	0.287												
R3112x42xA/C	4.116	4.200	4.284	0.126	0.210	0.294												
R3112x43xA/C	4.214	4.300	4.386	0.129	0.215	0.301												
R3112x44xA/C	4.312	4.400	4.488	0.132	0.220	0.308												
R3112x45xA/C	4.410	4.500	4.590	0.135	0.225	0.315												
R3112x46xA/C	4.508	4.600	4.692	0.138	0.230	0.322												
R3112x47xA/C	4.606	4.700	4.794	0.141	0.235	0.329												
R3112x48xA/C	4.704	4.800	4.896	0.144	0.240	0.336												
R3112x49xA/C	4.802	4.900	4.998	0.147	0.245	0.343												
R3112x50xA/C	4.900	5.000	5.100	0.150	0.250	0.350												

Output Current 3			Minimum Operating Voltage				Cd pin Threshold Voltage			Cd pin Output Current 1			Cd pin Output Current 2			Resistance for Output Delay			Detector Threshold Temperature		
I _{OUT3} [mA]			V _{DDL} [V]				V _{TCD} [V]			I _{CD1} [μA]			I _{CD2} [μA]			R _D [MΩ]			Δ-V _{DET} / ΔT _{opt} [ppm/°C]		
Condition	Min.	Typ.	Condition	Max.	Condition	Max.	Condition	Min.	Typ.	Max.	Condition	Min.	Typ.	Condition	Min.	Typ.	Min.	Typ.	Max.	Condition	Typ.
Pch	V _{DS} = -2.1V V _{DD} = 4.5V	1.5	3.5	0.7	-40°C ≧ T _{opt} ≦ 85°C	0.8	V _{DD} = (-V _{DET}) ×1.1V	0.297	0.495	0.693	V _{DS} = 0.1V V _{DD} = 0.7V	20	70	V _{DS} = 0.5V V _{DD} = 0.85V	10	400	3.25	6.5	13.0	-40°C ≧ T _{opt} ≦ 85°C	±100
								0.330	0.550	0.770											
								0.363	0.605	0.847											
								0.396	0.660	0.924											
								0.429	0.715	1.001											
								0.462	0.770	1.078											
								V _{DS} = 0.5V V _{DD} = 1.0V	50	450				3.25	6.5	13.0	-40°C ≧ T _{opt} ≦ 85°C	±100	0.495	0.825	1.155
																			0.528	0.880	1.232
																			0.561	0.935	1.309
																			0.594	0.990	1.386
																			0.627	1.045	1.463
																			0.660	1.100	1.540
																			0.693	1.155	1.617
																			0.726	1.210	1.694
																			0.759	1.265	1.771
	V _{DS} = -2.1V V _{DD} = 6.0V	2.0	4.5	0.7	-40°C ≧ T _{opt} ≦ 85°C	0.8	V _{DD} = (-V _{DET}) ×1.1V	V _{DS} = 0.1V V _{DD} = 0.7V	20	70	3.25	6.5	13.0	-40°C ≧ T _{opt} ≦ 85°C	±100						
																0.792	1.320	1.848			
																0.825	1.375	1.925			
																0.858	1.430	2.002			
																0.891	1.485	2.079			
																0.924	1.540	2.156			
																0.957	1.595	2.233			
																0.990	1.650	2.310			
																1.023	1.705	2.387			
																1.056	1.760	2.464			
																1.089	1.815	2.541			
																1.122	1.870	2.618			
																1.155	1.925	2.695			
																1.188	1.980	2.772			
																1.221	2.035	2.849			
1.254	2.090	2.926																			
1.287	2.145	3.003																			
1.320	2.200	3.080																			
1.353	2.255	3.157																			
1.386	2.310	3.234																			
1.419	2.365	3.311																			
1.452	2.420	3.388																			
1.485	2.475	3.465																			
1.518	2.530	3.542																			
1.551	2.585	3.619																			
1.584	2.640	3.696																			
1.617	2.695	3.773																			
1.650	2.750	3.850																			

R3112x

OPERATION

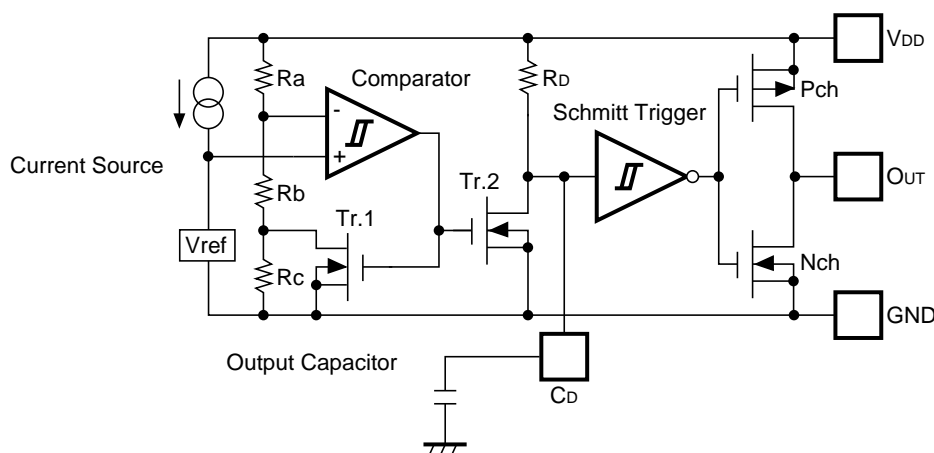
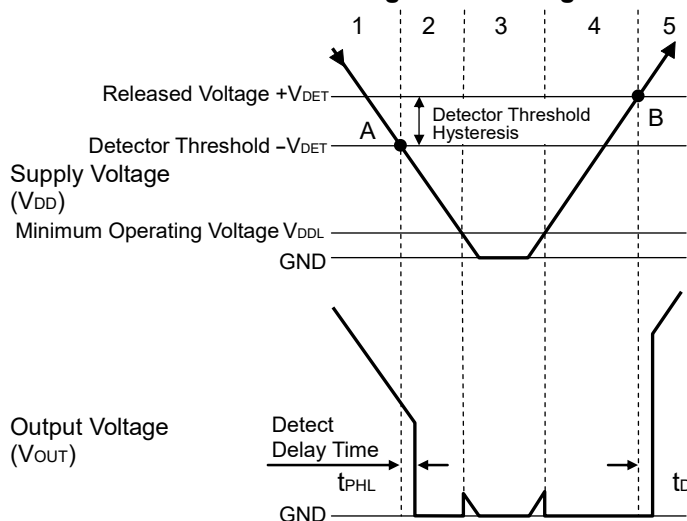

Fig. 1 Block Diagram with an external capacitor



Step	1	2	3	4	5
Comparator (-) Pin Input Voltage	I	II	II	II	I
Comparator Output	L	H	Indefinite	H	L
Tr.1,2	OFF	ON	Indefinite	ON	OFF
Output Tr.	Pch	ON	OFF	Indefinite	OFF
	Nch	OFF	ON	Indefinite	ON

$$I \quad \frac{Rb+Rc}{Ra+Rb+Rc} \times V_{DD}$$

$$II \quad \frac{Rb}{Ra+Rb} \times V_{DD}$$

Fig. 2 Operation Diagram

1. Output voltage is equal to supply voltage. (As for Nch open drain type, equal to pull-up voltage.)
 2. When the supply voltage is down to the detector threshold voltage level(Point A), $V_{ref} \geq V_{DD} \times (Rb+Rc)/(Ra+Rb+Rc)$ is true, then output of the comparator is reversed from "L" to "H", therefore output voltage becomes GND level.
 3. When the supply voltage is lower than minimum operating voltage, the operation of output transistor is indefinite. In the case of Nch open drain type, output voltage is equal to pull-up voltage.
 4. Output Voltage becomes GND level.
 5. When the supply voltage is higher than released voltage (Point B), $V_{ref} \leq V_{DD} \times Rb/(Ra+Rb)$ is true, then output of the comparator reaches the threshold level, and Output of Shmitt Trigger is reversed from "H" to "L", then output voltage is equal to supply voltage. (As for Nch open drain type, equal to pull-up voltage.)
- *) The difference between released voltage and detector threshold voltage means hysteresis range voltage.

• **Operation of Output Delay**

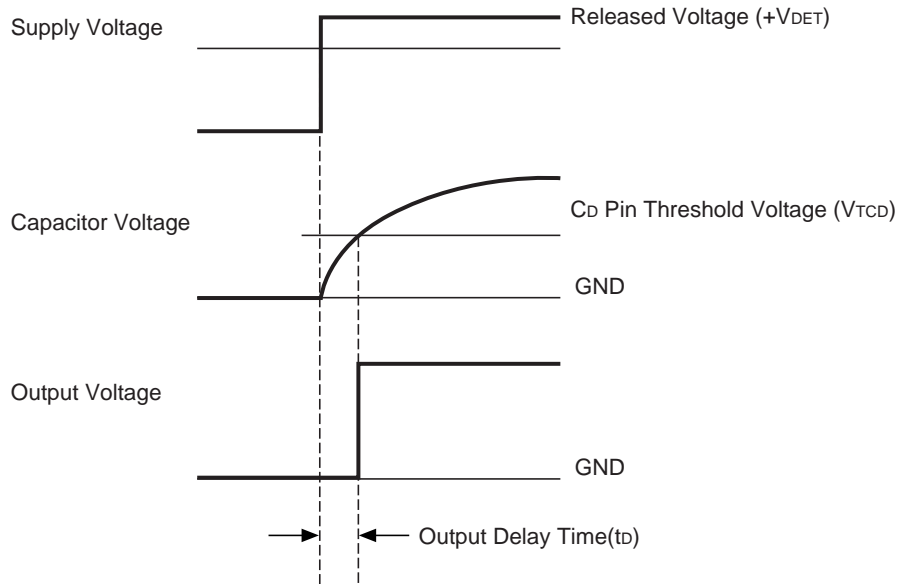

When the supply voltage which is higher than released voltage is forced to V_{DD} pin, charge to an external capacitor starts, then capacitor voltage increases. Until the capacitor voltage reaches to C_D pin threshold voltage, output voltage maintains "L". When the capacitor voltage becomes higher than C_D pin threshold voltage, output voltage is reversed from "L" to "H". Where, the time interval between the rising edge of supply voltage and output voltage reverse point means output delay time.

• **Output Delay Time**

Output Delay Time (t_D) can be calculated with the next formula.

$$t_D = 0.69 \times R_D \times C_D (\text{s})$$

R_D is internal resistor and set at $6.5\text{M}\Omega$ (Typ.) typically. C_D (F) describes the capacitance value of an external capacitor. Therefore,

$$t_D = 0.69 \times 6.5 \times 10^6 \times C_D (\text{s})$$

R3112x

TEST CIRCUITS

*Pull-up circuit is not necessary for CMOS Output type, or R3112xxxxC.

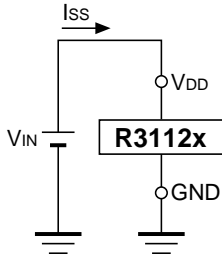

Supply Current Test Circuit

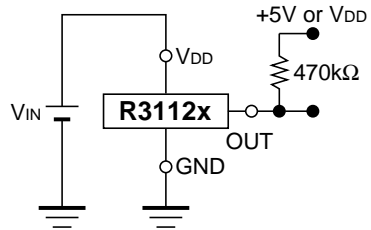

Detector Threshold Test Circuit

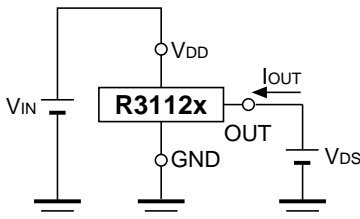

Nch Driver Output Current Test Circuit

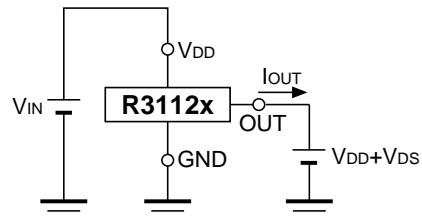

Pch Driver Output Current Test Circuit

*Apply only to CMOS

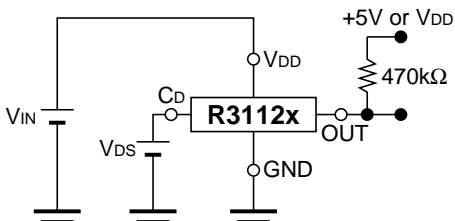

CD Pin Threshold Test Circuit

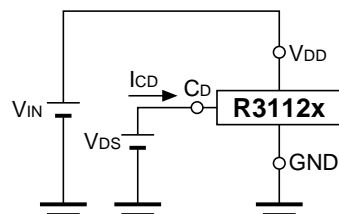

CD Pin Output Current Test Circuit

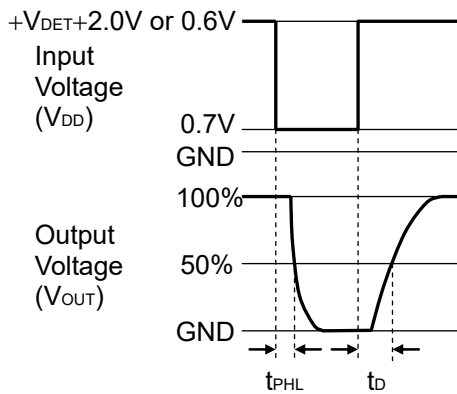

Output Delay Time Test Circuit

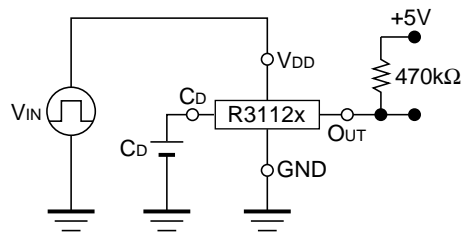

TYPICAL CHARACTERISTICS

1) Supply Current vs. Input Voltage

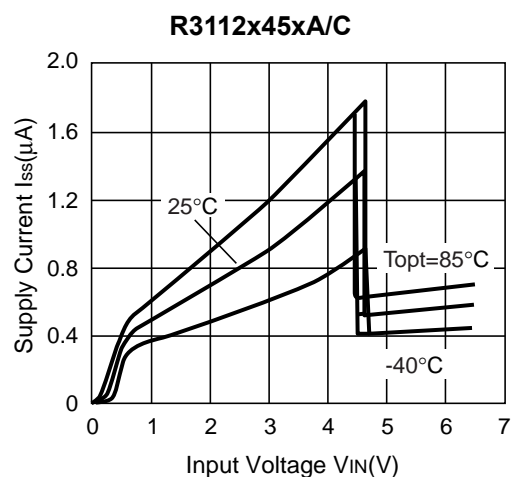
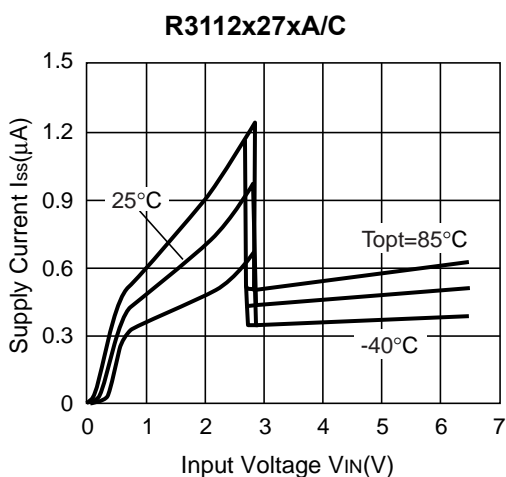
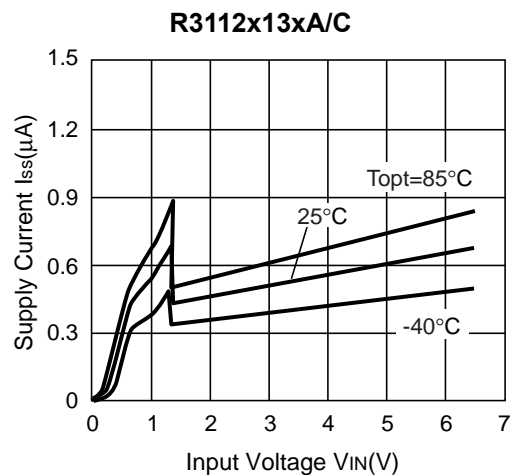
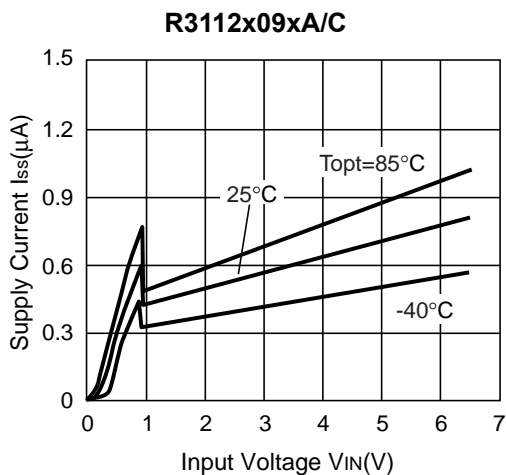

2) Detector Threshold vs. Temperature

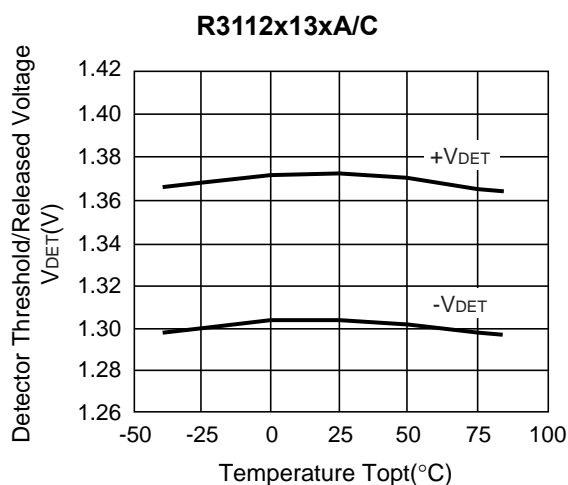
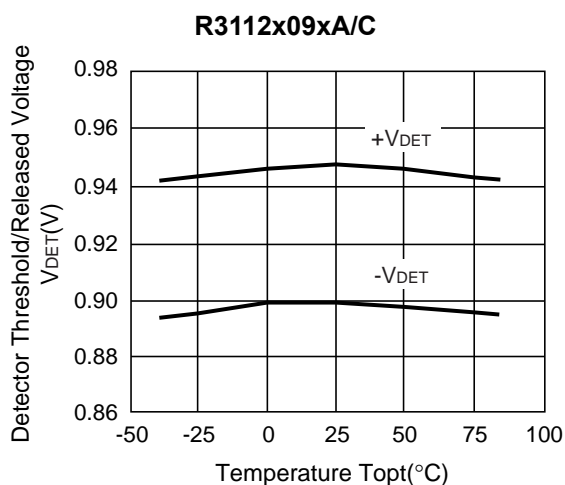

R3112x

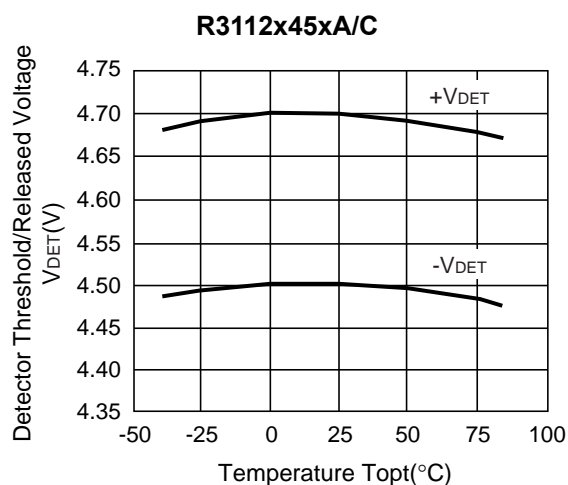
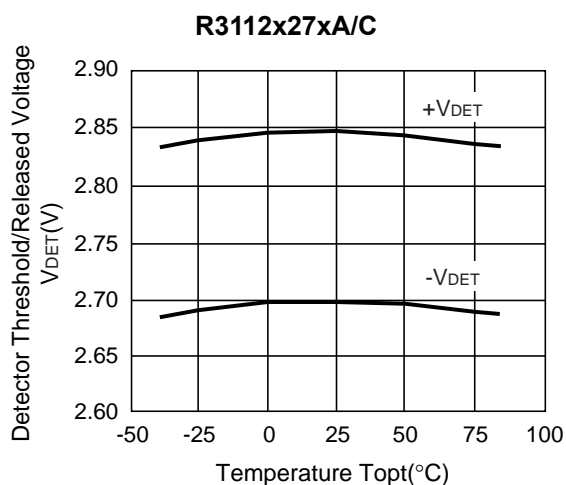

3) Output Voltage vs. Input Voltage

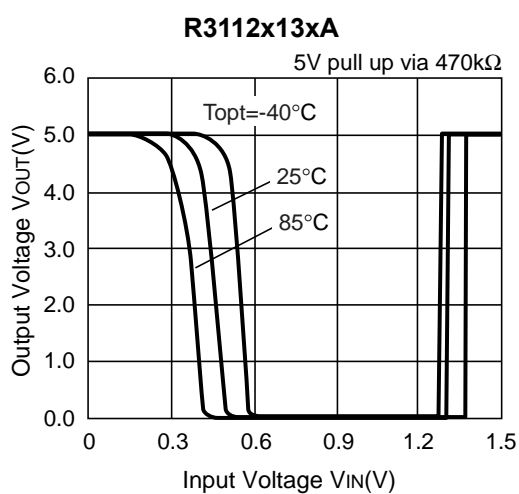
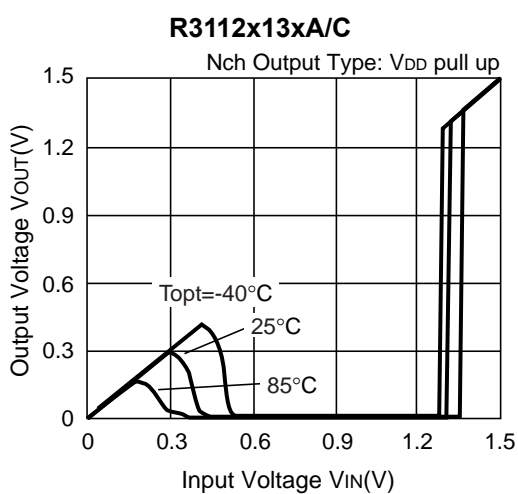
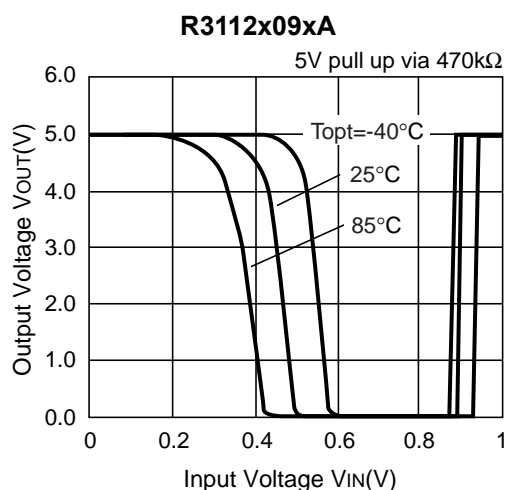
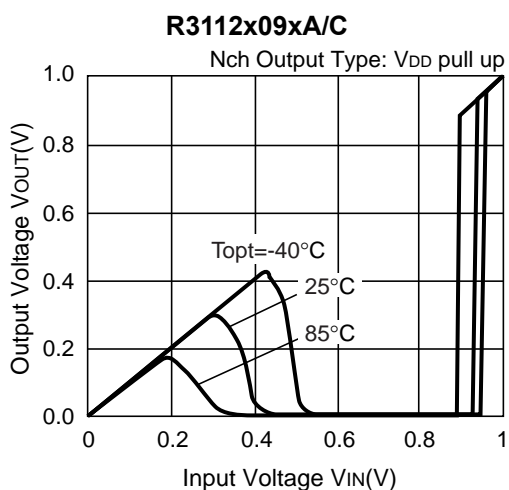

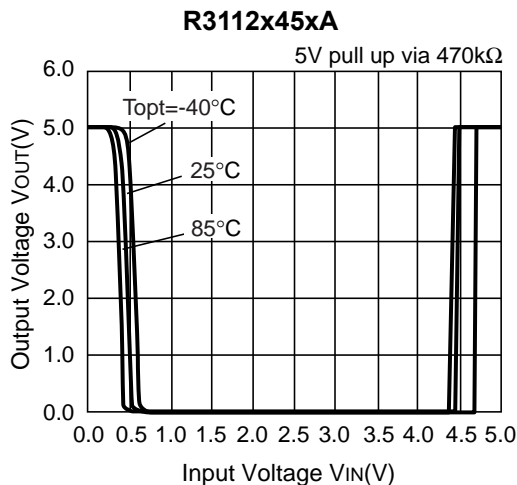
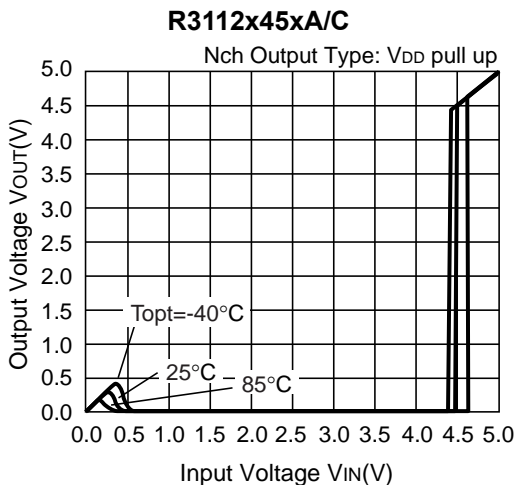
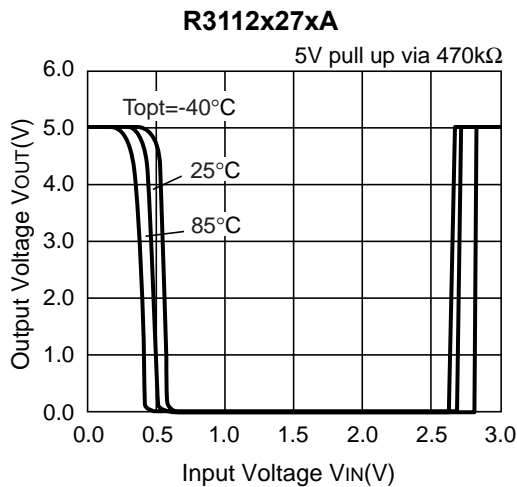
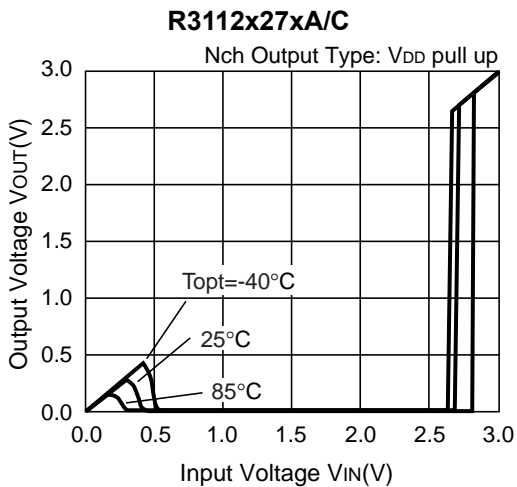

4) Nch Driver Output Current vs. V_{DS}

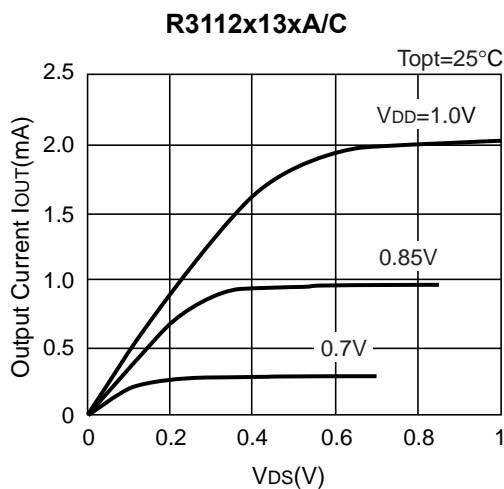
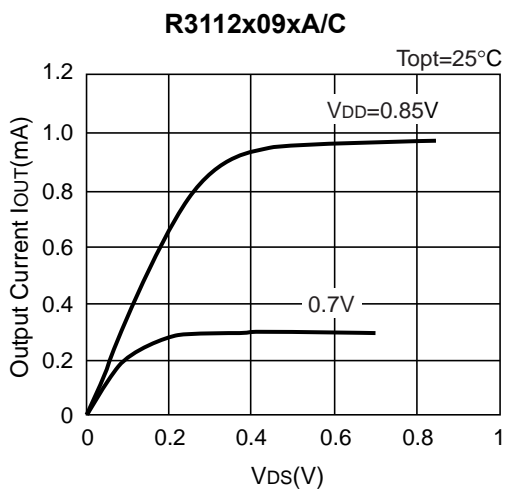

R3112x

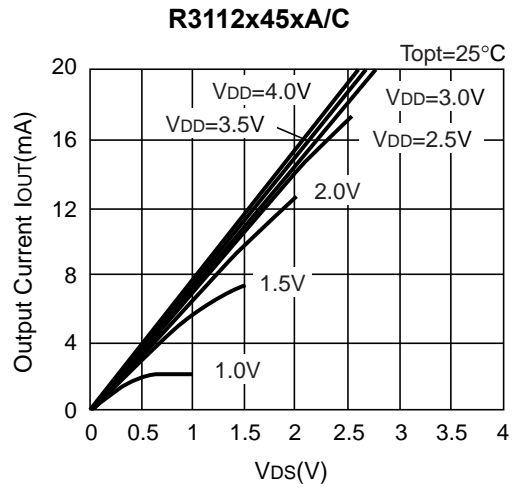
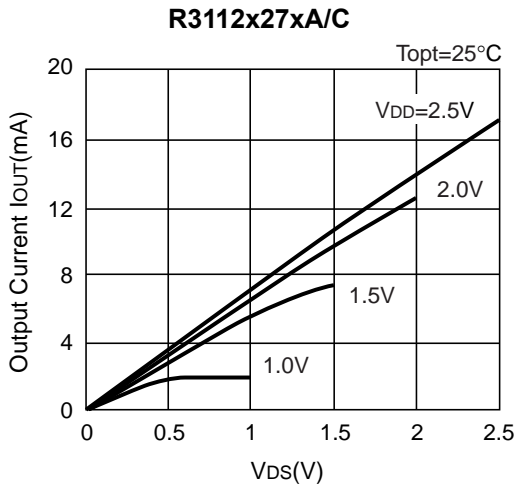

5) Nch Driver Output Current vs. Input Voltage

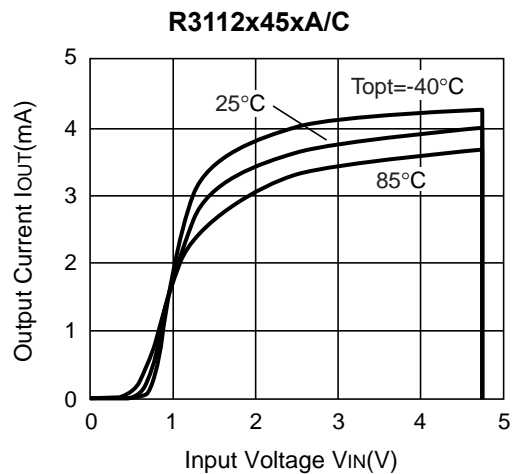
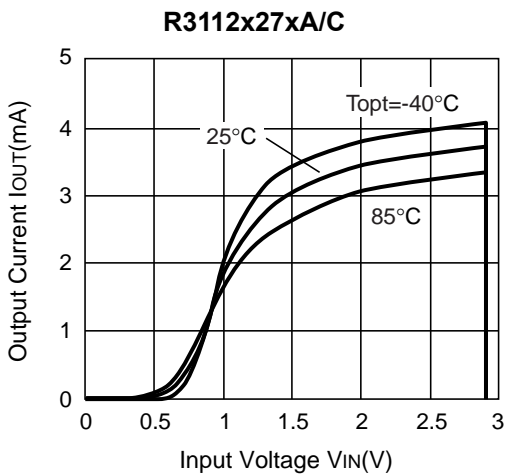
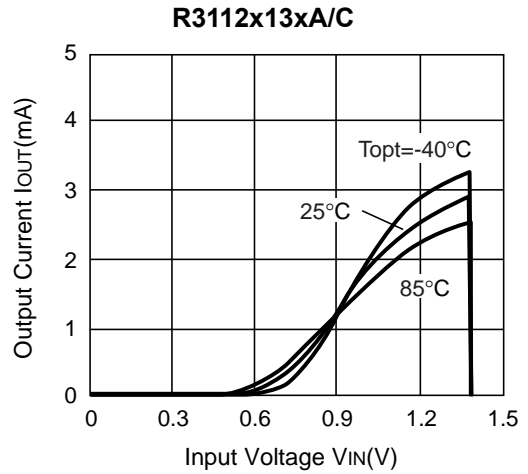
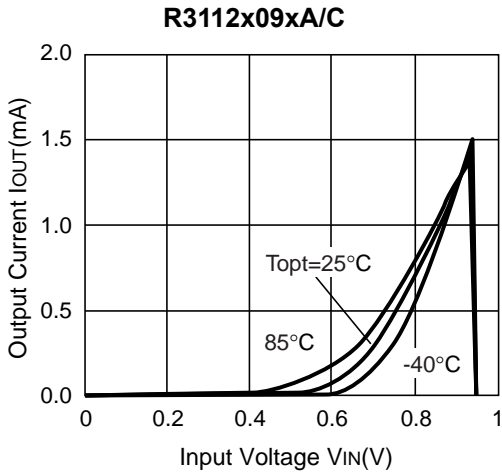

6) Pch Driver Output Current vs. Input Voltage

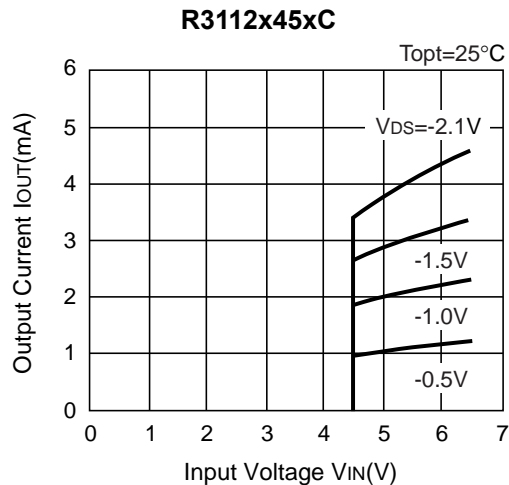
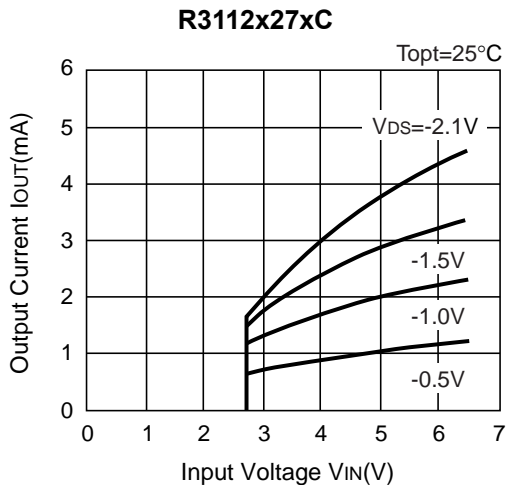
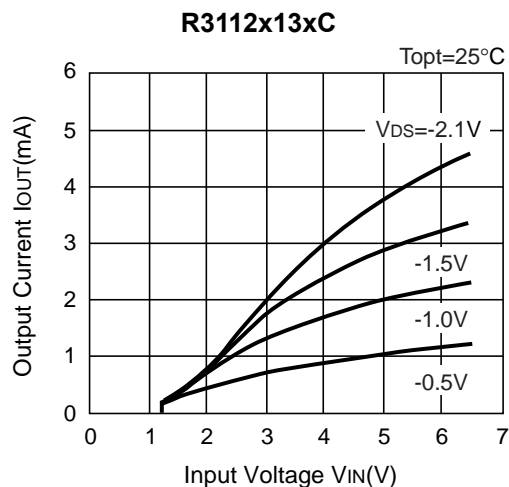
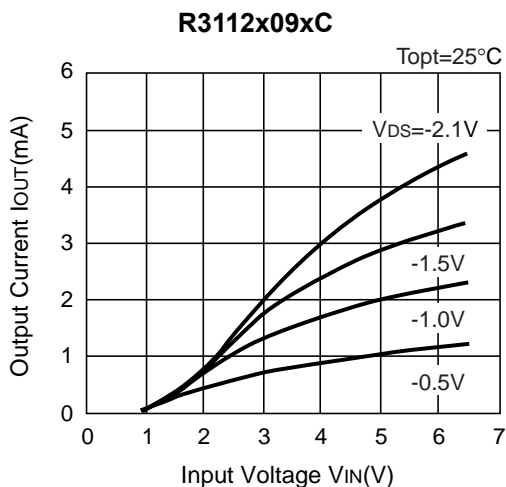

7) Cd Pin Threshold Voltage vs. Temperature

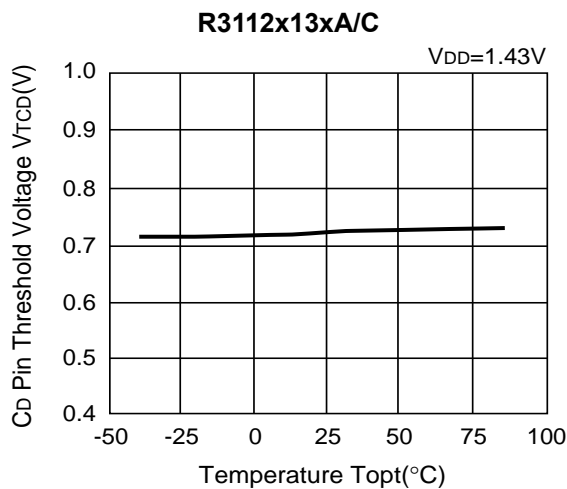
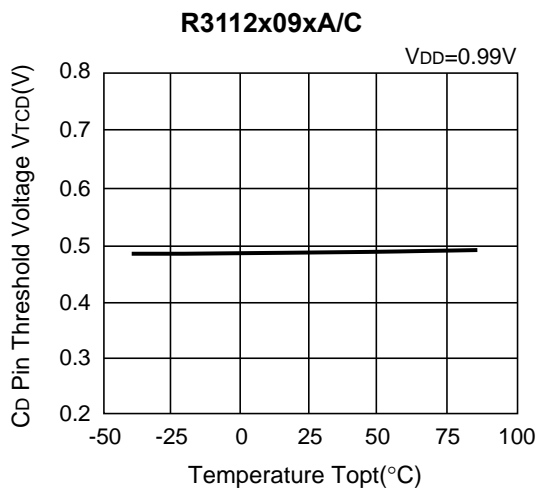

R3112x

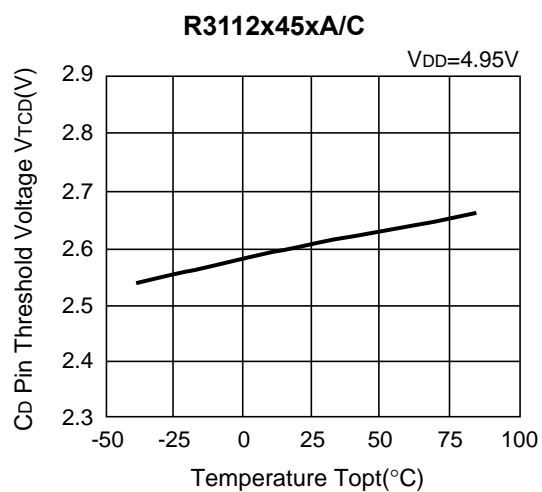
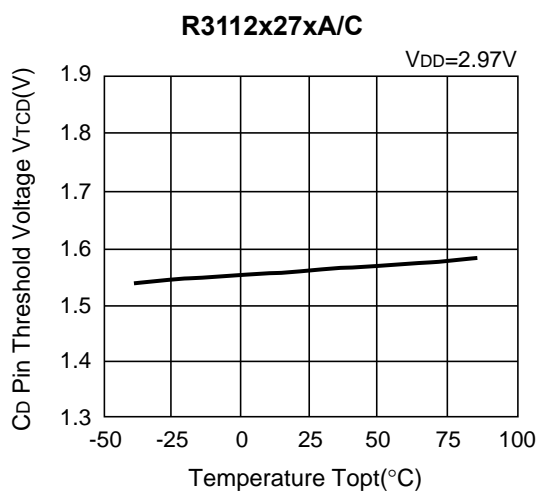

8) C_D Pin Output Current vs. Input Voltage

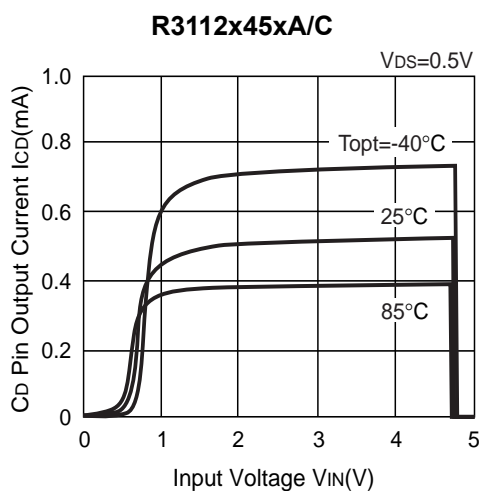
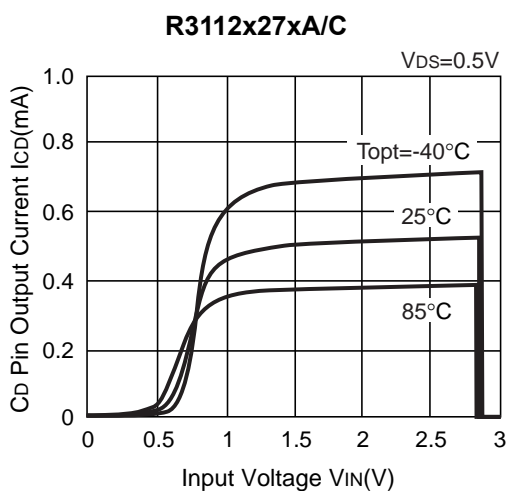
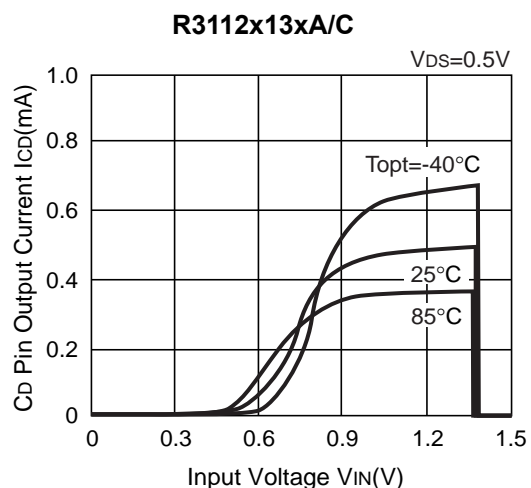
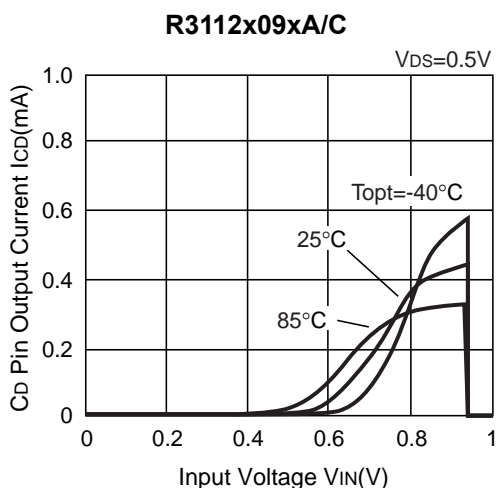

9) C_D Pin Output Current vs. V_{DS} ($T_{opt}=25^\circ C$)

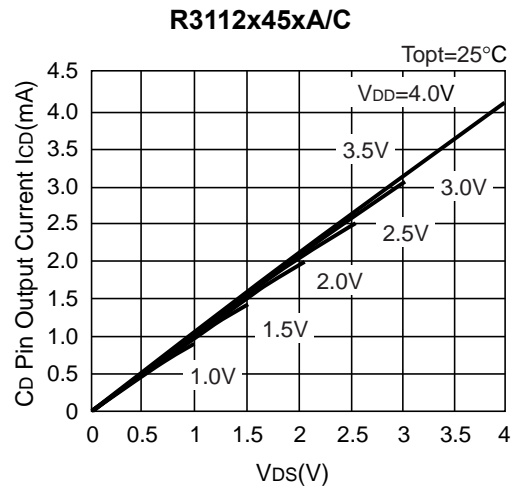
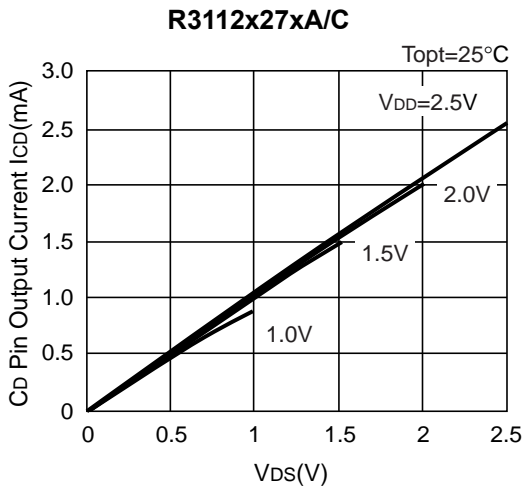
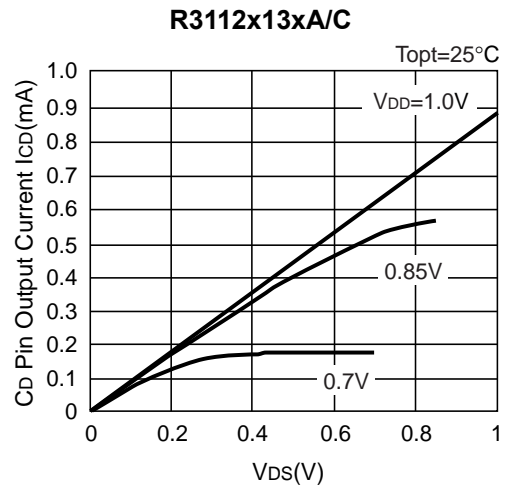
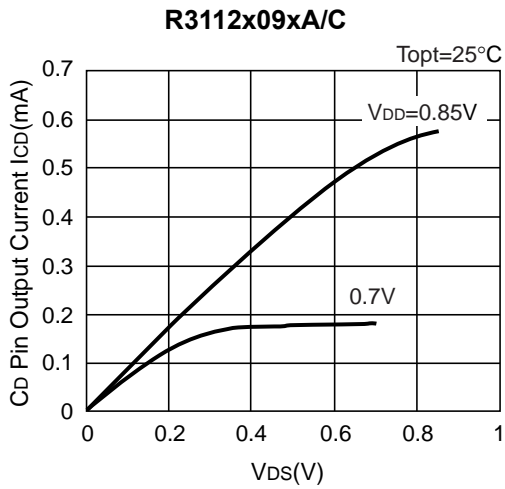

10) Output Delay Time vs. External Capacitance ($T_{opt}=25^\circ C$)

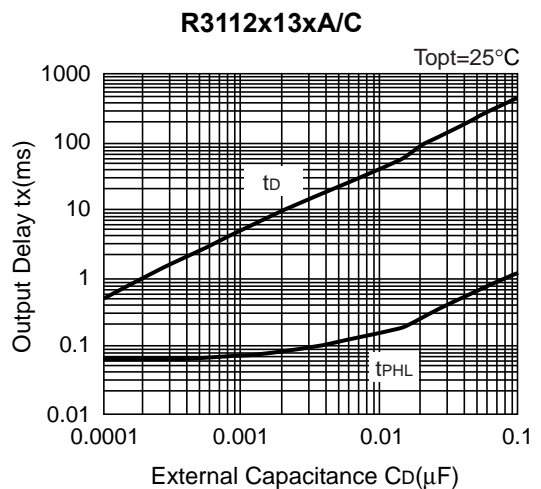
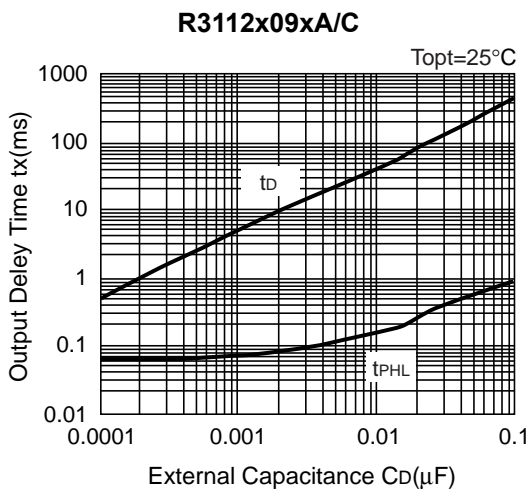

R3112x

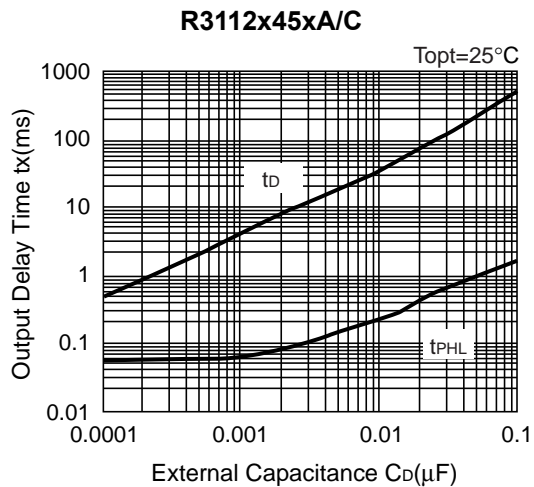
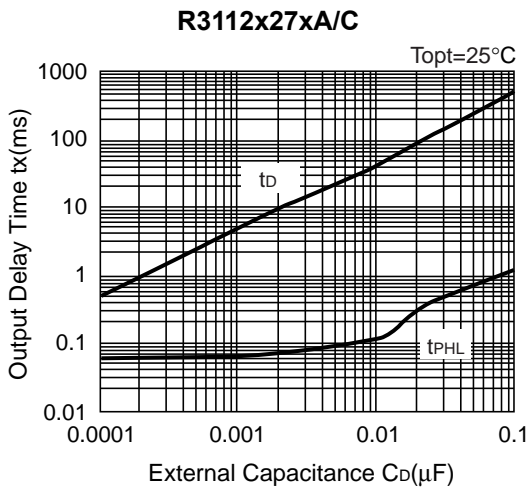

11) Delay Circuit Resistance vs. Temperature

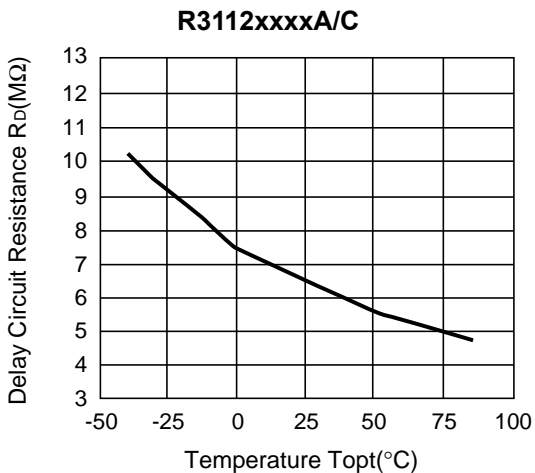

TECHNICAL NOTES

When connecting resistors to the device's input pin

When connecting a resistor (R1) to an input of this device, the input voltage decreases by [Device's Consumption Current] x [Resistance Value] only. And, the cross conduction current*¹, which occurs when changing from the detecting state to the release state, is decreased the input voltage by [Cross Conduction Current] x [Resistance Value] only. And then, this device will enter the re-detecting state if the input voltage reduction is larger than the difference between the detector voltage and the released voltage.

When the input resistance value is large and the VDD is gone up at mildly in the vicinity of the released voltage, repeating the above operation may result in the occurrence of output.

As shown in Figure A/B, set R1 to become 100 kΩ or less as a guide, and connect C_{IN} of 0.1 μF and more to between the input pin and GND. Besides, make evaluations including temperature properties under the actual usage condition, with using the evaluation board like this way. As a result, make sure that the cross conduction current has no problem.

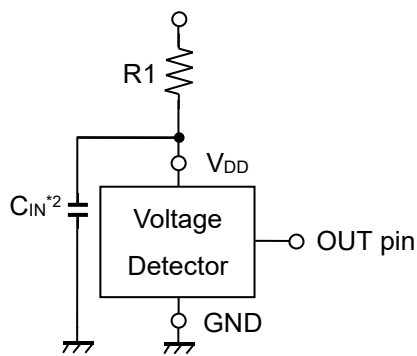

Figure A

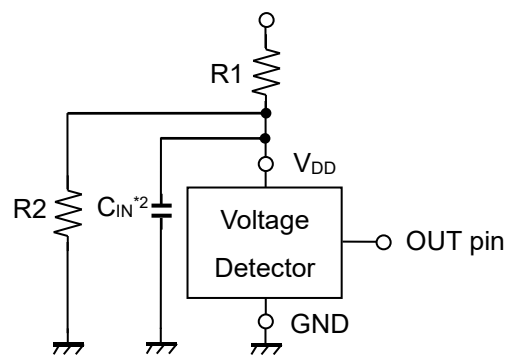

Figure B

*¹ In the CMOS output type, a charging current for OUT pin is included.

*² Note the bias dependence of capacitors.



1. The products and the product specifications described in this document are subject to change or discontinuation of production without notice for reasons such as improvement. Therefore, before deciding to use the products, please refer to Ricoh sales representatives for the latest information thereon.
2. The materials in this document may not be copied or otherwise reproduced in whole or in part without prior written consent of Ricoh.
3. Please be sure to take any necessary formalities under relevant laws or regulations before exporting or otherwise taking out of your country the products or the technical information described herein.
4. The technical information described in this document shows typical characteristics of and example application circuits for the products. The release of such information is not to be construed as a warranty of or a grant of license under Ricoh's or any third party's intellectual property rights or any other rights.
5. The products listed in this document are intended and designed for use as general electronic components in standard applications (office equipment, telecommunication equipment, measuring instruments, consumer electronic products, amusement equipment etc.). Those customers intending to use a product in an application requiring extreme quality and reliability, for example, in a highly specific application where the failure or misoperation of the product could result in human injury or death (aircraft, spacevehicle, nuclear reactor control system, traffic control system, automotive and transportation equipment, combustion equipment, safety devices, life support system etc.) should first contact us.
6. We are making our continuous effort to improve the quality and reliability of our products, but semiconductor products are likely to fail with certain probability. In order to prevent any injury to persons or damages to property resulting from such failure, customers should be careful enough to incorporate safety measures in their design, such as redundancy feature, fire containment feature and fail-safe feature. We do not assume any liability or responsibility for any loss or damage arising from misuse or inappropriate use of the products.
7. Anti-radiation design is not implemented in the products described in this document.
8. The X-ray exposure can influence functions and characteristics of the products. Confirm the product functions and characteristics in the evaluation stage.
9. WLCSP products should be used in light shielded environments. The light exposure can influence functions and characteristics of the products under operation or storage.
10. There can be variation in the marking when different AOI (Automated Optical Inspection) equipment is used. In the case of recognizing the marking characteristic with AOI, please contact Ricoh sales or our distributor before attempting to use AOI.
11. Please contact Ricoh sales representatives should you have any questions or comments concerning the products or the technical information.



Ricoh is committed to reducing the environmental loading materials in electrical devices with a view to contributing to the protection of human health and the environment.

Ricoh has been providing RoHS compliant products since April 1, 2006 and Halogen-free products since April 1, 2012.

RICOH RICOH ELECTRONIC DEVICES CO., LTD.

<https://www.e-devices.ricoh.co.jp/en/>

Sales & Support Offices

Ricoh Electronic Devices Co., Ltd.

Shin-Yokohama Office (International Sales)

2-3, Shin-Yokohama 3-chome, Kohoku-ku, Yokohama-shi, Kanagawa, 222-8530, Japan
Phone: +81-50-3814-7687 Fax: +81-45-474-0074

Ricoh Americas Holdings, Inc.

675 Campbell Technology Parkway, Suite 200 Campbell, CA 95008, U.S.A.
Phone: +1-408-610-3105

Ricoh Europe (Netherlands) B.V.

Semiconductor Support Centre

Prof. W.H. Keesomlaan 1, 1183 DJ Amstelveen, The Netherlands
Phone: +31-20-5474-309

Ricoh International B.V. - German Branch

Semiconductor Sales and Support Centre

Oberrather Strasse 6, 40472 Düsseldorf, Germany
Phone: +49-211-6546-0

Ricoh Electronic Devices Korea Co., Ltd.

3F, Haesung Bldg, 504, Teheran-ro, Gangnam-gu, Seoul, 135-725, Korea
Phone: +82-2-2135-5700 Fax: +82-2-2051-5713

Ricoh Electronic Devices Shanghai Co., Ltd.

Room 403, No.2 Building, No.690 Bibo Road, Pu Dong New District, Shanghai 201203,
People's Republic of China
Phone: +86-21-5027-3200 Fax: +86-21-5027-3299

Ricoh Electronic Devices Shanghai Co., Ltd.

Shenzhen Branch

1205, Block D (Jinlong Building), Kingkey 100, Hongbao Road, Luohu District,
Shenzhen, China
Phone: +86-755-8348-7600 Ext 225

Ricoh Electronic Devices Co., Ltd.

Taipei office

Room 109, 10F-1, No.51, Hengyang Rd., Taipei City, Taiwan
Phone: +886-2-2313-1621/1622 Fax: +886-2-2313-1623

X-ON Electronics

Largest Supplier of Electrical and Electronic Components

Click to view similar products for [Supervisory Circuits](#) category:

Click to view products by [Nisshinbo](#) manufacturer:

Other Similar products are found below :

[CAT1161LI-25-G](#) [CAT853STBI-T3](#) [CAT1026LI-30-G](#) [CAT1320LI-25-G](#) [TC54VN2402EMB713](#) [MCP1316T-44NE/OT](#) [MCP1316MT-45GE/OT](#) [MCP1316MT-23LI/OT](#) [MAX8997EWW+](#) [MAX6725AKASYD3-LF-T](#) [DS1232L](#) [NCV302HSN45T1G](#) [PT7M6130NLTA3EX](#) [PT7M7811STBEX-2017](#) [S-1000N28-I4T1U](#) [CAT1161LI-28-G](#) [MCP1321T-29AE/OT](#) [MCP1319MT-47QE/OT](#) [S-1000N23-I4T1U](#) [S-1000N19-I4T1U](#) [CAT824UTDI-GT3](#) [TC54VC2502ECB713](#) [PT7M6133NLTA3EX](#) [PT7M6127NLTA3EX](#) [VDA2510NTA](#) [AP0809ES3-r](#) [HG811RM4/TR](#) [MD7030C](#) [MD7033C](#) [MD7019](#) [MD7020](#) [MD7021](#) [MD7023](#) [MD7024](#) [MD7027](#) [MD7030](#) [MD7033](#) [MD7035](#) [MD7036](#) [MD7039](#) [MD7040](#) [MD7044](#) [MD7050](#) [MD7015](#) [MD7028](#) [MD7031](#) [MD7042](#) [MD7043](#) [MD7047](#) [MD7060](#)