1 Cell Li-ion/Li-polymer Protector

NO. EA-357-191125

OUTLINE

The R5487L/R5497L Series are high voltage tolerance CMOS-based protection IC for over-charge/discharge and over-current of rechargeable one-cell Lithium-ion (Li+)/Lithium polymer battery. The R5487L/R5497L Series can detect over-charge/discharge of Li+ one-cell and excess load current, further include a short circuit protector for preventing large external short circuit current and the excess charge-current.

The R5487L/R5497L Series are composed of four voltage detectors, reference units, a delay circuit, a short circuit protector, an oscillator, a counter, and logic circuits.

The output of Over-charge detector or Excess charge-current detector switches to "L" level after internally fixed delay time, when charged voltage crosses the detector threshold from a low value to a high value.

They have two types to release Over-charge detector. The one is called "Latch type". The output of C_{OUT} switches to "H" when a kind of load is connected to battery pack after a charger is disconnected from the battery pack, and the cell voltage becomes lower than over-charge detector threshold.

The other is called "Auto Release type". The output of C_{OUT} switches to "H", when the cell voltage is lower than over-charge detector release threshold, or by disconnecting a charger when the battery voltage is lower than over-charge detector threshold.

The output of Over-discharge detector or Excess discharge-current detector switches to "L" level after internally fixed delay time, when discharged voltage crosses the detector threshold from a high value to a value lower than V_{DET2}.

They have two types to release Over-discharge detector. The one is called "Latch type". In the case that a charger is connected to the battery pack, and V_{DD} level is more than over-discharge detector threshold, the output level of D_{OUT} becomes "H" immediately. The other is called "Auto Release type". In the case that a charger is connected to the battery pack, and V_{DD} level is more than over-discharge detector threshold, the output level of D_{OUT} becomes "H" immediately. Without connecting a charger, if V_{DD} pin voltage is equal or more than the released voltage from over-discharge, the output level of D_{OUT} becomes "H".

An excess discharge-current and short circuit state can be sensed and cut off through the built in excess current detector with D_{OUT} being enabled to low level. Once after detecting excess discharge-current or short circuit is released and D_{OUT} level switches to high by detaching a load system from a battery pack.

After detecting over-discharge, supply current will be kept extremely low by halting internal circuits' operation. When the output of C_{OUT} is "H", if V₋ pin level is set at V_{SS}-2V or lower, the delay time of detector can be shortened. Especially, the delay time of over-charge detector can be reduced into approximately 1/60. Therefore, testing time of protector circuit board can be reduced. Output type of C_{OUT} and D_{OUT} are CMOS.

The R5487L/R5497L Series have DFN1414-6B and DFN1814-6B.

FEATURES

Manufactured with High Voltage Tolerant Process

- Absolute Maximum Rating 30 V

Low Supply Current

- Supply current (At normal mode) Typ. 3.0 μ A
- At detecting over-discharge Max. 0.1 μ A (Over-discharge Latch type)
Max. 0.5 μ A (Over-discharge Auto-release type)

High Accuracy Detector Threshold

- Over-charge detector ± 20 mV ($T_a = 25^\circ\text{C}$)
 ± 25 mV ($-20^\circ\text{C} \leq T_a \leq 60^\circ\text{C}$)
- Over-discharge detector ± 35 mV
- Excess discharge-current detector (VDET3) ± 10 mV ($V_{\text{DET3}} \geq 0.100$ V)
 $\pm 10\%$ (0.050 V $\leq V_{\text{DET31}} < 0.100$ V)
 ± 5 mV ($V_{\text{DET31}} < 0.050$ V)
- Excess charge-current detector (VDET4) $\pm 10\%$ ($V_{\text{DET4}} \leq -0.05$ V)
 ± 5 mV ($V_{\text{DET4}} > -0.05$ V)

Variety of Detector Threshold

- Over-charge detector threshold 4.2 V to 4.6 V, 0.005 V step
- Over-discharge detector threshold 2.0 V to 3.0 V, 0.100 V step
- Over-discharge release threshold 2.4 V to 3.2 V, 0.100 V step
- Excess discharge-current threshold 0.025 V to 0.15 V, 0.001 V step
- Vshort threshold 0.15 V to 0.40 V, 0.005 V step
- Excess charge-current threshold -0.15 V to -0.02 V, 0.001 V step

Internal Fixed Output Delay Time

- Over-charge detector Output Delay 1.0 s
- Over-discharge detector Output Delay 20 ms
- Excess discharge-current detector Output Delay .. 12 ms
- Excess charge-current detector Output Delay 8 ms
- Short Circuit detector Output Delay 250 μ s

Output Delay Time Shortening Function

At C_{OUT} is "H", if V- level is set at typically -2 V, the Output Delay time of all items except short-circuit can be reduced (Delay Time for over-charge becomes about 1/60 of normal state).

Selectable Functions

- 0V-battery charge option Acceptable/Unacceptable
- Conditions for release over-charge detector Latch type/Auto Release type
- Conditions for release over-discharge detector Latch type/Auto Release type
- Conditions for release short-current detector Type 1/Type 2⁽¹⁾

Ultra Small Package

- The R5487L/R5497L Series have DFN1414-6B and DFN1814-6B.

⁽¹⁾ Load Resistance Threshold for release from Over-Discharge Current Status ($T_a = 25^\circ\text{C}$)

Type 1: more than 300 k Ω

Type 2: more than 25 k Ω

APPLICATIONS

- Li+ / Li Polymer protector of over-charge, over-discharge, excess-current for battery pack.
- High precision protectors for smart-phones and any other gadgets using on board Li+ / Li Polymer battery

SELECTION GUIDE

The voltage code, on, and package for the ICs can be selected by the user's request.

Product Name	Package	Quantity per Reel	Pb Free	Halogen Free
R5487Lyxx \$*-TR	DFN1414-6B ⇒ wiring A	5,000 pcs	Yes	Yes
R5497Lyxx \$*-TR	DFN1414-6B ⇒ wiring B	5,000 pcs	Yes	Yes
R5487Lyxx \$*-TR	DFN1814-6B	5,000 pcs	Yes	Yes

yxx: Set Voltage Code. Refer to *Product Code List*.

In the case of DFN1414-6B, y: 5 to 8,

In the case of DFN1814-6B, y: 1 to 4

Delay Time Code

\$:	Code	t _{VDET1} (s)	t _{VDET2} (ms)	t _{VDET3} (ms)	t _{VDET4} (ms)	t _{SHORT} (μs)
	K	1	20	12	8	250
	S	1	20	128	17	250

Function Code

*:	Code	Over-Charge	Over-Discharge	Excess-discharge-current ⁽¹⁾	0V Charge
	D	Auto-Release	Auto-Release	Auto-Release Type 1	OK
	F	Auto-Release	Auto-Release	Auto-Release Type 1	NG
	M	Auto-Release	Auto-Release	Auto-Release Type 2	OK
	P	Auto-Release	Auto-Release	Auto-Release Type 2	NG
	Q	Latch	Latch	Auto-Release Type 2	OK

⁽¹⁾ Load Resistance Threshold for release from Over-Discharge Current Status (T_a = 25°C)

Type 1: more than 300 kΩ

Type 2: more than 25 kΩ

Product Code List

Product Code Table

Code	V _{DET1} (V)	V _{REL1} (V)	V _{DET2} (V)	V _{REL2} (V)	V _{DET3} (V)	V _{DET4} (V)	V _{SHORT} (V)	t _{VDET1} (s)	t _{VDET2} (ms)	t _{VDET3} (ms)	t _{VDET4} (ms)	t _{SHORT} (μs)	0-V Charge
R5487L : DFN1814-6B													
R5487L102KD	4.475	4.275	2.500	2.900	0.065	-0.050	0.200	1	20	12	8	250	OK
R5487L102KP	4.475	4.275	2.500	2.900	0.065	-0.050	0.200	1	20	12	8	250	NG
R5487L103KM	4.425	4.225	2.500	2.900	0.100	-0.050	0.300	1	20	12	8	250	OK
R5487L105KD	4.475	4.275	2.500	2.900	0.130	-0.130	0.200	1	20	12	8	250	OK
R5487L106KD	4.400	4.100	2.500	2.800	0.043	-0.043	0.200	1	20	12	8	250	OK
R5487L107KD	4.425	4.225	2.800	3.000	0.090	-0.045	0.220	1	20	12	8	250	OK
R5487L111KD	4.425	4.225	2.500	2.800	0.130	-0.100	0.400	1	20	12	8	250	OK
R5487L113KD	4.280	4.080	2.600	2.700	0.075	-0.050	0.200	1	20	12	8	250	OK
R5487L114KD	4.280	4.080	2.600	2.700	0.050	-0.050	0.150	1	20	12	8	250	OK
R5487L116KD	4.475	4.275	2.500	2.900	0.032	-0.020	0.150	1	20	12	8	250	OK
R5487L116KM	4.475	4.275	2.500	2.900	0.032	-0.020	0.150	1	20	12	8	250	OK
R5487L117KP	4.450	4.250	2.500	2.900	0.100	-0.100	0.300	1	20	12	8	250	NG
R5487L118KM	4.415	4.215	2.500	2.900	0.045	-0.045	0.200	1	20	12	8	250	OK
R5487L119KM	4.420	4.220	2.500	2.900	0.050	-0.040	0.200	1	20	12	8	250	OK
R5487L120KP	4.475	4.275	2.500	2.900	0.045	-0.040	0.150	1	20	12	8	250	NG
R5487L121SD	4.550	4.250	2.000	2.400	0.030	-0.035	0.200	1	20	128	17	250	OK
R5487L122KM	4.470	4.270	2.500	2.900	0.050	-0.030	0.150	1	20	12	8	250	OK
R5487L123KM	4.475	4.275	2.500	2.900	0.055	-0.050	0.150	1	20	12	8	250	OK
R5487L124KD	4.475	4.275	2.500	2.900	0.065	-0.065	0.250	1	20	12	8	250	OK
R5487L125KD	4.550	4.350	2.300	2.500	0.065	-0.065	0.250	1	20	12	8	250	OK
R5487L126KF	4.470	4.270	2.800	3.000	0.047	-0.042	0.200	1	20	12	8	250	NG
R5487L127KD	4.475	4.275	2.500	2.900	0.065	-0.065	0.400	1	20	12	8	250	OK
R5487L128KF	4.470	4.270	2.800	3.000	0.045	-0.045	0.200	1	20	12	8	250	NG
R5487L129KP	4.525	4.325	2.500	2.900	0.055	-0.050	0.250	1	20	12	8	250	NG
R5487L130KP	4.470	4.270	2.500	2.800	0.045	-0.045	0.200	1	20	12	8	250	NG
R5487L135KP	4.500	4.300	2.500	2.900	0.045	-0.040	0.150	1	20	12	8	250	NG
R5487L137KP	4.550	4.300	2.500	2.900	0.045	-0.030	0.150	1	20	12	8	250	NG
R5487L142KQ	4.475	—	2.500	—	0.055	-0.050	0.150	1	20	12	8	250	OK

Product Code Table (Continued)

Code	V _{DET1} (V)	V _{REL1} (V)	V _{DET2} (V)	V _{REL2} (V)	V _{DET3} (V)	V _{DET4} (V)	V _{SHORT} (V)	t _{VDET1} (s)	t _{VDET2} (ms)	t _{VDET3} (ms)	t _{VDET4} (ms)	t _{SHORT} (μs)	0-V Charge
R5487L301KM	4.415	4.215	2.500	2.900	0.080	-0.080	0.300	1	20	12	8	250	OK
R5487L302KP	4.475	4.275	2.500	2.900	0.130	-0.100	0.300	1	20	12	8	250	NG
R5487L303KM	4.475	4.275	2.500	2.900	0.130	-0.130	0.300	1	20	12	16	250	OK
R5487L304KM	4.475	4.275	2.800	3.000	0.150	-0.130	0.300	1	20	12	16	250	OK
R5487L305KQ	4.475	-	2.500	-	0.130	-0.100	0.300	1	20	12	8	250	OK
R5487L306KQ	4.475	-	2.500	-	0.130	-0.065	0.300	1	20	12	8	250	OK
R5487L307KM	4.475	4.275	2.500	2.900	0.080	-0.070	0.200	1	20	12	16	250	OK
R5487L308KM	4.475	4.275	2.500	2.900	0.100	-0.080	0.300	1	20	12	16	250	OK
R5487L309KP	4.475	4.275	2.600	3.000	0.150	-0.100	0.400	1	20	12	8	250	NG
R5487L311KP	4.475	4.275	2.400	2.800	0.075	-0.075	0.250	1	20	12	8	250	NG
R5487L314KP	4.280	4.180	2.800	2.900	0.150	-0.100	0.300	1	20	12	8	250	NG
R5487L316KM	4.250	4.100	2.800	3.100	0.070	-0.030	0.200	1	20	12	16	250	OK
R5487L401KP	4.475	4.275	2.500	2.900	0.032	-0.030	0.150	1	20	12	8	250	NG
R5487L402KP	4.425	4.225	2.500	2.900	0.032	-0.030	0.150	1	20	12	8	250	NG
R5487L : DFN1414-6B													
R5487L504KM	4.425	4.225	2.500	2.900	0.032	-0.020	0.150	1	20	12	8	250	OK
R5497L : DFN1414-6B													
R5497L501KF	4.425	4.225	2.500	3.000	0.035	-0.020	0.150	1	20	12	16	250	NG
R5497L509KF	4.275	4.075	2.500	3.000	0.035	-0.020	0.150	1	20	12	16	250	NG
R5497L540KF	4.475	4.275	2.800	3.000	0.050	-0.050	0.150	1	20	12	16	250	NG

BLOCK DIAGRAMS

- R5487L/R5497Lxxx\$D, R5487L/R5497Lxxx\$F, R5487L/R5497Lxxx\$P, R5487L/R5497Lxxx\$M

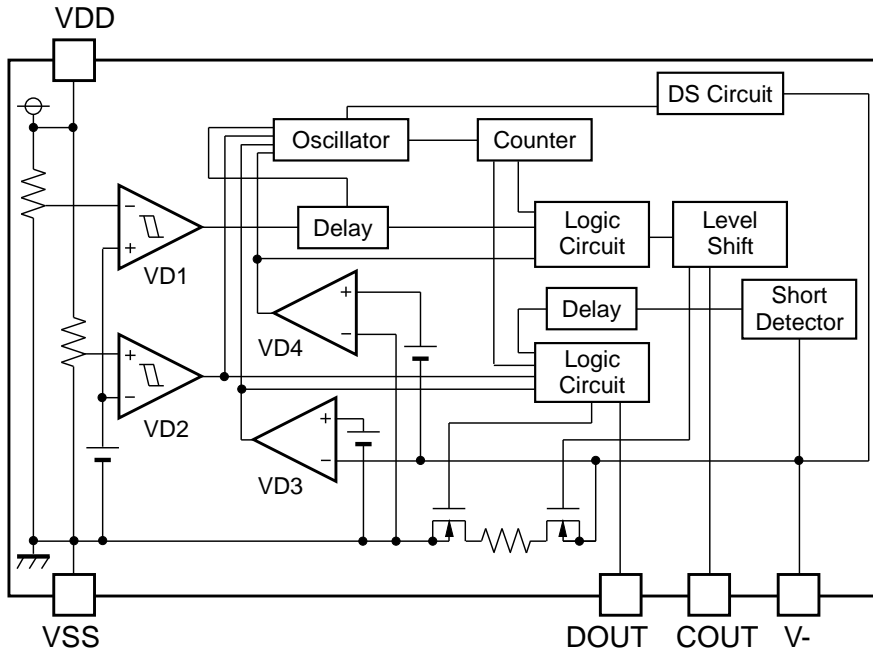

- R5487L/R5497Lxxx\$Q, R5487L/R5497Lxxx\$L

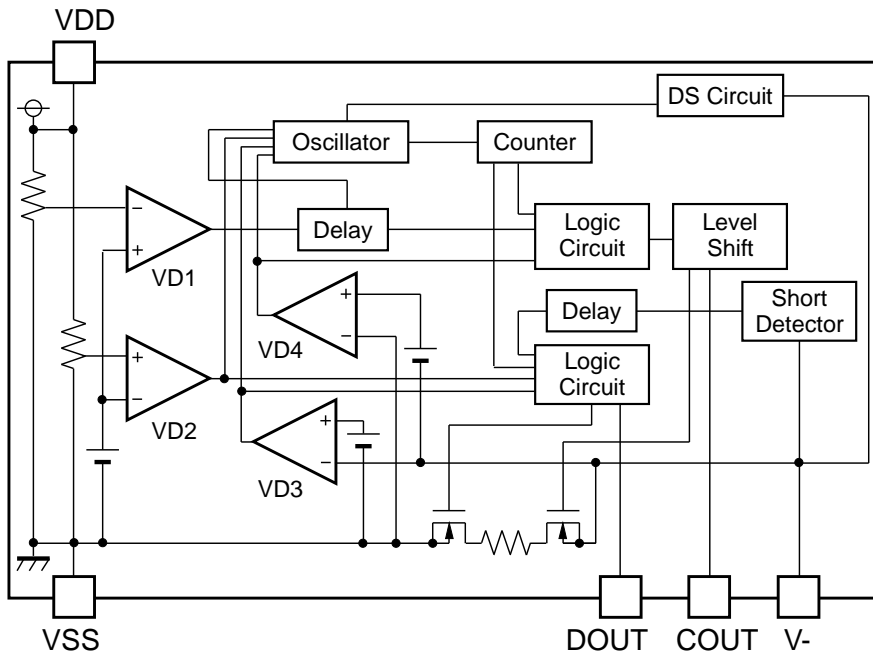

PIN DESCRIPTIONS

DFN1814-6B

R5487Lyxxxx (y:1 to 4)

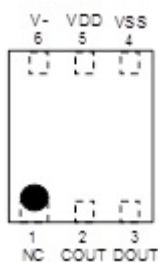

DFN1414-6B

⇒wiring A

R5487Lyxxxx (y:5 to 8)

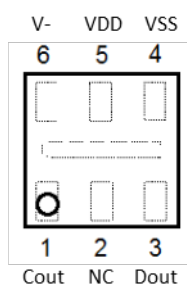

DFN1414-6B

⇒wiring B

R5497Lyxxxx (y:5 to 8)

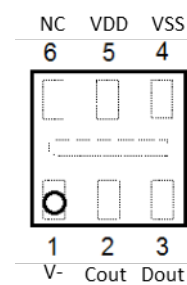

R5487L/R5497L Pin Configurations

Pin No.			Symbol	Description
R5487L		R5497L		
DFN1814-6B	DFN1414-6B (⇒ wiring A)	DFN1414-6B (⇒ wiring B)		
6	6	1	V-	Pin for charger negative input
5	5	5	VDD	Power supply pin, the substrate voltage level of the IC
2	1	2	COUT	Output of over-charge detection, CMOS output
3	3	3	DOUT	Output of over-discharge detection, CMOS output
1	2	6	NC	No Connection pin
4	4	4	VSS	VSS pin. Ground pin for the IC

ABSOLUTE MAXIMUM RATINGS

Symbol	Parameter	Rating	Unit
V _{DD}	Input Voltage	-0.3 to 12.0	V
V-	V- pin Input Voltage	V _{DD} -30 to V _{DD} +0.3	V
V _{COU} T	COU pin Output Voltage	V _{DD} -30 to V _{DD} +0.3	V
V _{DOU} T	DOU pin Output Voltage	V _{SS} -0.3 to V _{DD} +0.3	V
P _D	Power Dissipation (DFN1414-6B)	150	mW
	Power Dissipation (DFN1814-6B)	150	
T _j	Junction Temperature Range	-40 to 125	°C
T _{stg}	Storage Temperature Range	-55 to 125	°C

ABSOLUTE MAXIMUM RATINGS

Electronic and mechanical stress momentarily exceeded absolute maximum ratings may cause permanent damage and may degrade the life time and safety for both device and system using the device in the field. The functional operation at or over these absolute maximum ratings is not assured.

RECOMMENDED OPERATING CONDITIONS

Symbol	Parameter	Rating	Unit
V _{DD1}	Operating Voltage	1.5 to 5.0	V
T _a	Operating Temperature Range	-40 to 85	°C

RECOMMENDED OPERATING CONDITIONS

All of electronic equipment should be designed that the mounted semiconductor devices operate within the recommended operating conditions. The semiconductor devices cannot operate normally over the recommended operating conditions, even if they are used over such ratings by momentary electronic noise or surge. And the semiconductor devices may receive serious damage when they continue to operate over the recommended operating conditions.

ELECTRICAL CHARACTERISTICS

R5487LxxxKD Electrical Characteristics

Unless otherwise provided, Ta=25°C

Symbol	Parameter	Conditions	Min.	Typ.	Max.	Unit	Circuit (1)	
V _{ST}	Minimum Operating Voltage for 0V Charging	Voltage Defined as V _{DD} -V-, V _{DD} -V _{SS} = 0V			1.8	V	A	
V _{DET1}	Over-charge Threshold Voltage	R1=330Ω	V _{DET1} -0.020	V _{DET1}	V _{DET1} +0.020	V	B	
		R1 = 330Ω, -20°C ≤ Ta ≤ 60°C ⁽²⁾	V _{DET1} -0.025		V _{DET1} +0.025	V		
V _{REL1}	Released voltage from Over-charge	R1 = 330Ω	V _{REL1} -0.05	V _{REL1}	V _{REL1} +0.05	V	B	
t _{VDET1}	Output Delay of Over-charge	V _{DD} = 3.6V → 4.65V	0.7	1.0	1.3	s	B	
t _{VREL1}	Release Delay for VD1	V _{DD} = 4.65V → 3.6V	11	16	21	ms	C	
V _{DET2}	Over-discharge Threshold	Detect falling edge of supply voltage	V _{DET2} -0.035	V _{DET2}	V _{DET2} +0.035	V	D	
V _{REL2}	Released Voltage from Over-discharge	Detect rising edge of supply voltage	V _{REL2} x0.975	V _{REL2}	V _{REL2} x1.025	V	M	
t _{VDET2}	Output Delay of Over-discharge	V _{DET2} ≥ 2.1V, V _{DD} = 3.6V → 2.0V	14	20	26	ms	D	
		V _{DET2} < 2.1V, V _{DD} = 3.6V → 1.9V	14	20	26	ms		
t _{VREL2}	Release Delay for VD2	V _{DET2} ≥ 2.1V, V _{DD} = 2.0V → 3.6V	0.7	1.2	1.7	ms	E	
		V _{DET2} < 2.1V, V _{DD} = 1.9V → 3.6V	0.7	1.2	1.7	ms		
V _{DET3}	Excess discharge-current threshold	Detect rising edge of 'V-' pin voltage, V _{DD} = 3.1V	V _{DET3} ≤ 0.05V	V _{DET3}	V _{DET3} -0.005	V _{DET3} +0.005	V	F
			0.05V < V _{DET3} < 0.1V		V _{DET3} x0.9	V _{DET3} x1.1	V	
			V _{DET3} ≥ 0.1V		V _{DET3} -0.010	V _{DET3} +0.010	V	
t _{VDET3}	Output delay of excess discharge-current	V _{DD} = 3.1V, V- = 0V → [V _{SHORT} x0.77-0.01V]	8	12	16	ms	F	
t _{VREL3}	Output delay of release from excess discharge-current	V _{DD} = 3.1V, V- = 3.1V → 0V	0.7	1.2	1.7	ms	F	
V _{SHORT}	Short Protection Voltage	V _{DD} = 3.1V	V _{SHORT} x0.75	V _{SHORT}	V _{SHORT} x1.25	V	F	
t _{SHORT}	Delay Time for Short Protection	V _{DD} = 3.1V, V- = 0V → 0.5V	180	250	425	μs	F	
R _{SHORT}	Reset Resistance for Excess Current Protection	V _{DD} = 3.6V, V- = 1.0V	14	20.5	27	kΩ	F	

(1) Refer to TEST CIRCUITS for details.

(2) Considering of variation in process parameters, we compensate for this characteristic related to temperature by laser-trim, however, this specification is guaranteed by design, not mass production tested.

R5487LxxxKD Electrical Characteristics (Continued) Unless otherwise provided, Ta=25°C

Symbol	Parameter	Conditions	Min.	Typ.	Max.	Unit	Circuit (1)	
V _{DET4}	Excess charge-current Threshold	Detect falling edge of 'V-' pin voltage, V _{DD} = 3.1V	V _{DET4} > -0.05V	V _{DET4} -0.005	V _{DET4}	V _{DET4} +0.005	V	G
		V _{DET4} ≤ -0.05V	V _{DET4} x1.1	V _{DET4} x0.9		V		
t _{VDET4}	Output delay of excess charge-current	V _{DD} = 3.1V, V- = 0V → -1V	5	8	11	ms	G	
t _{VREL4}	Output delay of release from excess charge-current	V _{DD} = 3.1V, V- = -1V → 0V	0.7	1.2	1.7	ms	G	
V _{DS}	Delay Time Shortening Mode Voltage	V _{DD} = 3.6V	-2.6	-2.0	-1.4	V	G	
V _{OL1}	Nch ON-Voltage of COUT	I _{ol} = 50μA, V _{DD} = 4.8V		0.4	0.5	V	H	
V _{OH1}	Pch ON-Voltage of COUT	I _{oh} = -50μA, V _{DD} = 3.9V	3.4	3.7		V	I	
V _{OL2}	Nch ON-Voltage of DOUT	V _{DET2} ≥ 2.1V, I _{ol} = 50μA, V _{DD} = 2.0V		0.2	0.5	V	J	
		V _{DET2} < 2.1V, I _{ol} = 50μA, V _{DD} = 1.9V		0.2	0.5	V		
V _{OH2}	Pch ON-Voltage of DOUT	I _{oh} = -50μA, V _{DD} = 3.9V	3.4	3.7		V	K	
I _{DD}	Supply Current	V _{DD} = 3.9V, V- = 0V		3.0	6.0	μA	L	
I _{STANDBY}	Standby Current	V _{DET2} ≥ 2.1V, V _{DD} = 2.0V			0.5	μA	L	
		V _{DET2} < 2.1V, V _{DD} = 1.9V			0.5	μA		

(1) Refer to TEST CIRCUITS for details.

R5487LxxxKM Electrical Characteristics

Unless otherwise provided, Ta=25°C

Symbol	Parameter	Conditions	Min.	Typ.	Max.	Unit	Circuit (1)	
V _{ST}	Minimum Operating Voltage for 0V Charging	Voltage Defined as V _{DD} -V ₋ , V _{DD} -V _{SS} = 0V			1.8	V	A	
V _{DET1}	Over-charge Threshold Voltage	R1 = 330Ω	V _{DET1} -0.020	V _{DET1}	V _{DET1} +0.020	V	B	
		R1 = 330Ω, -20°C ≤ Ta ≤ 60°C ⁽²⁾	V _{DET1} -0.025		V _{DET1} +0.025			
V _{REL1}	Released voltage from Over-charge	R1 = 330Ω	V _{REL1} -0.05	V _{REL1}	V _{REL} +0.05	V	B	
t _{VDET1}	Output Delay of Over-charge	V _{DD} = 3.6V → 4.65V	0.7	1.0	1.3	s	B	
t _{VREL1}	Release Delay for VD1	V _{DD} = 4.65V → 3.6V	11	16	21	ms	C	
V _{DET2}	Over-discharge Threshold	Detect falling edge of supply voltage	V _{DET2} -0.035	V _{DET2}	V _{DET2} +0.035	V	D	
V _{REL2}	Released Voltage from Over-discharge	Detect rising edge of supply voltage	V _{REL2} x0.975	V _{REL2}	V _{REL2} x1.025	V	M	
t _{VDET2}	Output Delay of Over-discharge	V _{DET2} ≥ 2.1V, V _{DD} = 3.6V → 2.0V	14	20	26	ms	D	
		V _{DET2} < 2.1V, V _{DD} = 3.6V → 1.9V	14	20	26	ms		
t _{VREL2}	Release Delay for VD2	V _{DET2} ≥ 2.1V, V _{DD} = 2.0V → 3.6V	0.7	1.2	1.7	ms	E	
		V _{DET2} < 2.1V, V _{DD} = 1.9V → 3.6V	0.7	1.2	1.7	ms	F	
V _{DET3}	Excess discharge-current threshold	Detect rising edge of 'V-' pin voltage, V _{DD} = 3.1V	V _{DET3} ≤ 0.05V	V _{DET3}	V _{DET3} -0.005	V	F	
			0.05V < V _{DET3} < 0.1V		V _{DET3} x0.9			V _{DET3} x1.1
			V _{DET3} ≥ 0.1V		V _{DET3} -0.010			V _{DET3} +0.010
V _{REL3}	Released Voltage from Excess discharge-current	Detect falling edge of 'V-' pin Voltage, V _{DD} = 3.1V	1.82	1.935	2.05	V	F	
t _{VDET3}	Output delay of excess discharge-current	V _{DD} = 3.1V, V ₋ = 0V → [V _{SHORT} x0.77-0.01V]	8	12	16	ms	F	
t _{VREL3}	Output delay of release from excess discharge-current	V _{DD} = 3.1V, V ₋ = 3.1V → 0V	0.7	1.2	1.7	ms	F	
V _{SHORT}	Short Protection Voltage	V _{DD} = 3.1V	V _{SHORT} x0.75	V _{SHORT}	V _{SHORT} x1.25	V	F	
t _{SHORT}	Delay Time for Short Protection	V _{DD} = 3.1V, V ₋ = 0V → 0.5V	180	250	425	μs	F	

(1) Refer to TEST CIRCUITS for details.

(2) Considering of variation in process parameters, we compensate for this characteristic related to temperature by laser-trim, however, this specification is guaranteed by design, not mass production tested.

R5487LxxxKM Electrical Characteristics (Continued) Unless otherwise provided, Ta=25°C

Symbol	Parameter	Conditions	Min.	Typ.	Max.	Unit	Circuit (1)
R _{SHORT}	Reset Resistance for Excess Current Protection	V _{DD} = 3.6V, V ₋ = 1.0V	18	22	26	kΩ	F
V _{DET4}	Excess charge-current Threshold	Detect falling edge of 'V-' pin voltage, V _{DD} = 3.1V	V _{DET4} > -0.05V -0.005	V _{DET4}	V _{DET4} +0.005	V	G
			V _{DET4} ≤ -0.05V x1.1		V _{DET4} x0.9	V	
t _{VDET4}	Output delay of excess charge-current	V _{DD} = 3.1V, V ₋ = 0V → -1V	5	8	11	ms	G
t _{VREL4}	Output delay of release from excess charge-current	V _{DD} = 3.1V, V ₋ = -1V → 0V	0.7	1.2	1.7	ms	G
V _{DS}	Delay Time Shortening Mode Voltage	V _{DD} = 3.6V	-2.6	-2.0	-1.4	V	G
V _{OL1}	Nch ON-Voltage of COUT	I _{ol} = 50μA, V _{DD} = 4.8V		0.4	0.5	V	H
V _{OH1}	Pch ON-Voltage of COUT	I _{oh} = -50μA, V _{DD} = 3.9V	3.4	3.7		V	I
V _{OL2}	Nch ON-Voltage of DOUT	V _{DET2} ≥ 2.1V, I _{ol} = 50μA, V _{DD} = 2.0V		0.2	0.5	V	J
		V _{DET2} < 2.1V, I _{ol} = 50μA, V _{DD} = 1.9V		0.2	0.5	V	
V _{OH2}	Pch ON-Voltage of DOUT	I _{oh} = -50μA, V _{DD} = 3.9V	3.4	3.7		V	K
I _{DD}	Supply Current	V _{DD} = 3.9V, V ₋ = 0V		3.0	6.0	μA	L
I _{STANDBY}	Standby Current	V _{DET2} ≥ 2.1V, V _{DD} = 2.0V			0.5	μA	L
		V _{DET2} < 2.1V, V _{DD} = 1.9V			0.5	μA	

(1) Refer to TEST CIRCUITS for details.

R5497LxxxKF Electrical Characteristics

Unless otherwise provided, Ta=25°C

Symbol	Parameter	Conditions	Min.	Typ.	Max.	Unit	Circuit (1)	
V _{NOCHG}	Maximum Operating Voltage for Inhibition of Charger	Voltage Defined as V _{DD} -V _{SS} , V _{DD} -V ₋ = 4V	0.8	1.2	1.6	V	A	
V _{DET1}	Over-charge Threshold Voltage	R1 = 330Ω	V _{DET1} -0.020	V _{DET1}	V _{DET1} +0.020	V	B	
		-20°C ≤ Ta ≤ 60°C ⁽²⁾	V _{DET1} -0.025		V _{DET1} +0.025			
V _{REL1}	Released voltage from Over-charge	R1 = 330Ω	V _{REL1} -0.05	V _{REL1}	V _{REL1} +0.05	V	B	
t _{VDET1}	Output Delay of Over-charge	V _{DD} = 3.6V → 4.65V	0.7	1.0	1.3	s	B	
t _{VREL1}	Release Delay for VD1	V _{DD} = 4.65V → 3.6V	11	16	21	ms	C	
V _{DET2}	Over-discharge Threshold	Detect falling edge of supply voltage	V _{DET2} -0.035	V _{DET2}	V _{DET2} +0.035	V	D	
V _{REL2}	Released Voltage from Over-discharge	Detect rising edge of supply voltage	V _{REL2} x0.975	V _{REL2}	V _{REL2} x1.025	V	M	
t _{VDET2}	Output Delay of Over-discharge	V _{DET2} ≥ 2.1V, V _{DD} = 3.6V → 2.0V	14	20	26	ms	D	
		V _{DET2} < 2.1V, V _{DD} = 3.6V → 1.9V	14	20	26	ms		
t _{VREL2}	Release Delay for VD2	V _{DET2} ≥ 2.1V, V _{DD} = 2.0V → 3.6V	0.7	1.2	1.7	ms	E	
		V _{DET2} < 2.1V, V _{DD} = 1.9V → 3.6V	0.7	1.2	1.7	ms		
V _{DET3}	Excess discharge-current threshold	Detect rising edge of 'V-' pin voltage. V _{DD} = 3.1V	V _{DET3} ≤ 0.05V	V _{DET3}	V _{DET3} -0.005	V	F	
			0.05V < V _{DET3} < 0.1V		V _{DET3} x0.9			V _{DET3} x1.1
			V _{DET3} ≥ 0.1V		V _{DET3} -0.010			V _{DET3} +0.010
t _{VDET3}	Output delay of excess discharge-current	V _{DD} = 3.1V, V ₋ = 0V → [V _{SHORT} x 0.77-0.01V]	8	12	16	ms	F	
t _{VREL3}	Output delay of release from excess discharge-current	V _{DD} = 3.1V, V ₋ = 3.1V → 0V	0.7	1.2	1.7	ms	F	
V _{SHORT}	Short Protection Voltage	V _{DD} = 3.1V	V _{SHORT} x0.75	V _{SHORT}	V _{SHORT} x1.25	V	F	
t _{SHORT}	Delay Time for Short Protection	V _{DD} = 3.1V, V ₋ = 0V → 0.5V	180	250	425	μs	F	
R _{SHORT}	Reset Resistance for Excess Current Protection	V _{DD} = 3.6V, V ₋ = 1.0V	14	20.5	27	kΩ	F	

(1) Refer to TEST CIRCUITS for details.

(2) Considering of variation in process parameters, we compensate for this characteristic related to temperature by laser-trim, however, this specification is guaranteed by design, not mass production tested.

R5497LxxxKF Electrical Characteristics (Continued) Unless otherwise provided, Ta=25°C

Symbol	Parameter	Conditions	Min.	Typ.	Max.	Unit	Circuit (1)	
V _{DET4}	Excess charge-current Threshold	Detect falling edge of 'V-' pin voltage, V _{DD} = 3.1V	V _{DET4} > -0.05V	V _{DET4} -0.005	V _{DET4}	V _{DET4} +0.005	V	G
			V _{DET4} ≤ -0.05V	V _{DET4} × 1.1		V _{DET4} × 0.9	V	
t _{VDET4}	Output delay of excess charge-current	V _{DD} = 3.1V, V- = 0V → -1V	5	8	11	ms	G	
t _{VREL4}	Output delay of release from excess charge-current	V _{DD} = 3.1V, V- = -1V → 0V	0.7	1.2	1.7	ms	G	
V _{DS}	Delay Time Shortening Mode Voltage	V _{DD} = 3.6V	-2.6	-2.0	-1.4	V	G	
V _{OL1}	Nch ON-Voltage of COUT	I _{ol} = 50μA, V _{DD} = 4.8V		0.4	0.5	V	H	
V _{OH1}	Pch ON-Voltage of COUT	I _{oh} = -50μA, V _{DD} = 3.9V	3.4	3.7		V	I	
V _{OL2}	Nch ON-Voltage of DOUT	V _{DET2} ≥ 2.1V I _{ol} = 50μA, V _{DD} = 2.0V		0.2	0.5	V	J	
		V _{DET2} < 2.1V I _{ol} = 50μA, V _{DD} = 1.9V		0.2	0.5	V		
V _{OH2}	Pch ON-Voltage of DOUT	I _{oh} = -50μA, V _{DD} = 3.9V	3.4	3.7		V	K	
I _{DD}	Supply Current	V _{DD} = 3.9V, V- = 0V		3.0	6.0	μA	L	
I _{STANDBY}	Standby Current	V _{DET2} ≥ 2.1V, V _{DD} = 2.0V			0.5	μA	L	
		V _{DET2} < 2.1V, V _{DD} = 1.9V			0.5	μA		

(1) Refer to TEST CIRCUITS for details.

R5487LxxxKP Electrical Characteristics

Unless otherwise provided, Ta=25°C

Symbol	Parameter	Conditions	Min.	Typ.	Max.	Unit	Circuit (1)	
V _{NOCHG}	Maximum Operating Voltage for Inhibition of Charger	Voltage Defined as V _{DD} -V _{SS} , V _{DD} -V ₋ = 4V	0.8	1.2	1.6	V	A	
V _{DET1}	Over-charge Threshold Voltage	R1 = 330Ω	V _{DET1} -0.020	V _{DET1}	V _{DET1} +0.020	V	B	
		-20°C ≤ Ta ≤ 60°C ⁽²⁾	V _{DET1} -0.025		V _{DET1} +0.025			
V _{REL1}	Released voltage from Over-charge	R1 = 330Ω	V _{REL1} -0.05	V _{REL1}	V _{REL1} +0.05	V	B	
t _{VDET1}	Output Delay of Over-charge	V _{DD} = 3.6V → 4.65V	0.7	1.0	1.3	s	B	
t _{VREL1}	Release Delay for VD1	V _{DD} = 4.65V → 3.6V	11	16	21	ms	C	
V _{DET2}	Over-discharge Threshold	Detect falling edge of supply voltage	V _{DET2} -0.035	V _{DET2}	V _{DET2} +0.035	V	D	
V _{REL2}	Released Voltage from Over-discharge	Detect rising edge of supply voltage	V _{REL2} x0.975	V _{REL2}	V _{REL2} x1.025	V	M	
t _{VDET2}	Output Delay of Over-discharge	V _{DET2} ≥ 2.1V, V _{DD} = 3.6V → 2.0V	14	20	26	ms	D	
		V _{DET2} < 2.1V, V _{DD} = 3.6V → 1.9V	14	20	26	ms		
t _{VREL2}	Release Delay for VD2	V _{DET2} ≥ 2.1V, V _{DD} = 2.0V → 3.6V	0.7	1.2	1.7	ms	E	
		V _{DET2} < 2.1V, V _{DD} = 1.9V → 3.6V	0.7	1.2	1.7	ms		
V _{DET3}	Excess discharge-current threshold	Detect rising edge of 'V-' pin voltage, V _{DD} = 3.1V	V _{DET3} ≤ 0.05V	V _{DET3}	V _{DET3} -0.005	V	F	
			0.05V < V _{DET3} < 0.1V		V _{DET3} x0.9			V _{DET3} x1.1
			V _{DET3} ≥ 0.1V		V _{DET3} -0.010			V _{DET3} +0.010
V _{REL3}	Released Voltage from Excess discharge-current	Detect falling edge of 'V-' pin voltage, V _{DD} = 3.1V	1.82	1.935	2.05	V	F	
t _{VDET3}	Output delay of excess discharge-current	V _{DD} = 3.1V, V ₋ = 0V → [V _{SHORT} x0.77-0.01V]	8	12	16	ms	F	
t _{VREL3}	Output delay of release from excess discharge-current	V _{DD} = 3.1V, V ₋ = 3.1V → 0V	0.7	1.2	1.7	ms	F	
V _{SHORT}	Short Protection Voltage	V _{DD} = 3.1V	V _{SHORT} x 0.75	V _{SHORT}	V _{SHORT} x 1.25	V	F	
t _{SHORT}	Delay Time for Short Protection	V _{DD} = 3.1V, V ₋ = 0V → 0.5V	180	250	425	μs	F	
R _{SHORT}	Reset Resistance for Excess Current Protection	V _{DD} = 3.6V, V ₋ = 1.0V	18	22	26	kΩ	F	

(1) Refer to TEST CIRCUITS for details.

(2) Considering of variation in process parameters, we compensate for this characteristic related to temperature by laser-trim, however, this specification is guaranteed by design, not mass production tested.

R5487LxxxKP Electrical Characteristics (Continued)

Unless otherwise provided, Ta=25°C

Symbol	Parameter	Conditions	Min.	Typ.	Max.	Unit	Circuit (1)	
V _{DET4}	Excess charge-current Threshold	Detect falling edge of 'V-' pin voltage, V _{DD} = 3.1V	V _{DET4} > -0.05V	V _{DET4} -0.005	V _{DET4}	V _{DET4} +0.005	V	G
		V _{DET4} ≤ -0.05V	V _{DET4} ×1.1	V _{DET4} ×0.9		V		
t _{VDET4}	Output delay of excess charge-current	V _{DD} = 3.1V, V- = 0V → -1V	5	8	11	ms	G	
t _{VREL4}	Output delay of release from excess charge-current	V _{DD} = 3.1V, V- = -1V → 0V	0.7	1.2	1.7	ms	G	
V _{DS}	Delay Time Shortening Mode Voltage	V _{DD} = 3.6V	-2.6	-2.0	-1.4	V	G	
V _{OL1}	Nch ON-Voltage of COUT	I _{ol} = 50μA, V _{DD} = 4.8V		0.4	0.5	V	H	
V _{OH1}	Pch ON-Voltage of COUT	I _{oh} = -50μA, V _{DD} = 3.9V	3.4	3.7		V	I	
V _{OL2}	Nch ON-Voltage of DOUT	V _{DET2} ≥ 2.1V, I _{ol} = 50μA, V _{DD} = 2.0V		0.2	0.5	V	J	
		V _{DET2} < 2.1V, I _{ol} = 50μA, V _{DD} = 1.9V		0.2	0.5	V		
V _{OH2}	Pch ON-Voltage of DOUT	I _{oh} = -50μA, V _{DD} = 3.9V	3.4	3.7		V	K	
I _{DD}	Supply Current	V _{DD} = 3.9V, V- = 0V		3.0	6.0	μA	L	
I _{STANDBY}	Standby Current	V _{DET2} ≥ 2.1V, V _{DD} = 2.0V			0.5	μA	L	
		V _{DET2} < 2.1V, V _{DD} = 1.9V			0.5	μA		

(1) Refer to TEST CIRCUITS for details.

R5487LxxxKQ Electrical Characteristics

Unless otherwise provided, Ta=25°C

Symbol	Parameter	Conditions	Min.	Typ.	Max.	Unit	Circuit (1)	
V _{ST}	Minimum Operating Voltage for 0V Charging	Voltage Defined as V _{DD} -V-, V _{DD} -V _{SS} = 0V			1.8	V	A	
V _{DET1}	Over-charge Threshold Voltage	R1 = 330Ω	V _{DET1} -0.020	V _{DET1}	V _{DET1} +0.020	V	B	
		-20°C ≤ Ta ≤ 60°C ⁽²⁾	V _{DET1} -0.025		V _{DET1} +0.025			
t _{VD1}	Output Delay of Over-charge	V _{DD} = 3.6V → 4.65V	0.7	1.0	1.3	s	B	
t _{VREL1}	Release Delay for VD1	V _{DD} = 4.0V, V- = 0V → 0.2V	11	16	21	ms	C	
V _{DET2}	Over-discharge Threshold	Detect falling edge of supply voltage	V _{DET2} -0.035	V _{DET2}	V _{DET2} +0.035	V	D	
t _{VD2}	Output Delay of Over-discharge	V _{DET2} ≥ 2.1V, V _{DD} = 3.6V → 2.0V	14	20	26	ms	D	
		V _{DET2} < 2.1V, V _{DD} = 3.6V → 1.9V	14	20	26	ms		
t _{VREL2}	Release Delay for VD2	V _{DET2} ≥ 2.1V, V _{DD} = 2.0V → 3.6V	0.7	1.2	1.7	ms	E	
		V _{DET2} < 2.1V, V _{DD} = 1.9V → 3.6V	0.7	1.2	1.7	ms		
V _{DET3}	Excess discharge-current threshold	Detect rising edge of 'V-' pin voltage, V _{DD} = 3.1V	V _{DET3} ≤ 0.05V	V _{DET3}	V _{DET3} -0.005	V	F	
			0.05V < V _{DET3} < 0.1V		V _{DET3} × 0.9			V _{DET3} × 1.1
			V _{DET3} ≥ 0.1V		V _{DET3} -0.010			V _{DET3} +0.010
V _{REL3}	Released Voltage from Excess discharge-current	Detect falling edge of 'V-' pin voltage, V _{DD} = 3.1V	1.82	1.935	2.05	V	F	
t _{VD3}	Output delay of excess discharge-current	V _{DD} = 3.1V, V- = 0V → [V _{SHORT} × 0.77-0.01V]	8	12	16	ms	F	
t _{VREL3}	Output delay of release from excess discharge-current	V _{DD} = 3.1V, V- = 3.1V → 0V	0.7	1.2	1.7	ms	F	
V _{SHORT}	Short Protection Voltage	V _{DD} = 3.1V	V _{SHORT} × 0.75	V _{SHORT}	V _{SHORT} × 1.25	V	F	
t _{SHORT}	Delay Time for Short Protection	V _{DD} = 3.1V, V- = 0V → 0.5V	180	250	425	μs	F	
R _{SHORT}	Reset Resistance for Excess Current Protection	V _{DD} = 3.6V, V- = 1.0V	18	22	26	kΩ	F	

(1) Refer to TEST CIRCUITS for details.

(2) Considering of variation in process parameters, we compensate for this characteristic related to temperature by laser-trim, however, this specification is guaranteed by design, not mass production tested.

R5487LxxxKQ Electrical Characteristics (Continued) Unless otherwise provided, Ta=25°C

Symbol	Parameter	Conditions	Min.	Typ.	Max.	Unit	Circuit (1)	
V _{DET4}	Excess charge-current Threshold	Detect falling edge of 'V-' pin voltage, V _{DD} = 3.1V	V _{DET4} > -0.05V	V _{DET4} -0.005	V _{DET4}	V _{DET4} +0.005	V	G
		V _{DET4} ≤ -0.05V	V _{DET4} ×1.1	V _{DET4} ×0.9		V		
t _{VDET4}	Output delay of excess charge-current	V _{DD} = 3.1V, V- = 0V → -1V	5	8	11	ms	G	
t _{VREL4}	Output delay of release from excess charge-current	V _{DD} = 3.1V, V- = -1V → 0V	0.7	1.2	1.7	ms	G	
V _{DS}	Delay Time Shortening Mode Voltage	V _{DD} = 3.6V	-2.6	-2.0	-1.4	V	G	
V _{OL1}	Nch ON-Voltage of COUT	I _{ol} = 50μA, V _{DD} = 4.8V		0.4	0.5	V	H	
V _{OH1}	Pch ON-Voltage of COUT	I _{oh} = -50μA, V _{DD} = 3.9V	3.4	3.7		V	I	
V _{OL2}	Nch ON-Voltage of DOUT	V _{DET2} ≥ 2.1V, I _{ol} = 50μA, V _{DD} = 2.0V		0.2	0.5	V	J	
		V _{DET2} < 2.1V, I _{ol} = 50μA, V _{DD} = 1.9V		0.2	0.5	V		
V _{OH2}	Pch ON-Voltage of DOUT	I _{oh} = -50μA, V _{DD} = 3.9V	3.4	3.7		V	K	
I _{DD}	Supply Current	V _{DD} = 3.9V, V- = 0V		3.0	6.0	μA	L	
I _{STANDBY}	Standby Current	V _{DET2} ≥ 2.1V, V _{DD} = 2.0V			0.1	μA	L	
		V _{DET2} < 2.1V, V _{DD} = 1.9V			0.1	μA		

(1) Refer to TEST CIRCUITS for details.

R5487LxxxSD Electrical Characteristics

Unless otherwise provided, Ta=25°C

Symbol	Parameter	Conditions	Min.	Typ.	Max.	Unit	Circuit (1)		
V _{ST}	Minimum Operating Voltage for 0V Charging	Voltage Defined as V _{DD} -V ₋ , V _{DD} -V _{SS} = 0V			1.8	V	A		
V _{DET1}	Over-charge Threshold Voltage	R1 = 330Ω	V _{DET1} -0.020	V _{DET1}	V _{DET1} +0.020	V	B		
		R1 = 330Ω, -20°C ≤ Ta ≤ 60°C ⁽²⁾	V _{DET1} -0.025		V _{DET1} +0.025				
V _{REL1}	Released voltage from Over-charge	R1 = 330Ω	V _{REL1} -0.05	V _{REL1}	V _{REL1} +0.05	V	B		
t _{VDET1}	Output Delay of Over-charge	V _{DD} = 3.6 V → 4.65 V	0.7	1.0	1.3	s	B		
t _{VREL1}	Release Delay for VD1	V _{DD} = 4.65 V → 3.6 V	11	16	21	ms	C		
V _{DET2}	Over-discharge Threshold	Detect falling edge of supply voltage	V _{DET2} -0.035	V _{DET2}	V _{DET2} +0.035	V	D		
V _{REL2}	Released Voltage from Over-discharge	Detect rising edge of supply voltage	V _{REL2} × 0.975	V _{REL2}	V _{REL2} × 1.025	V	M		
t _{VDET2}	Output Delay of Over-discharge	V _{DET2} ≥ 2.1V, V _{DD} = 3.6 V → 2.0 V	14	20	26	ms	D		
		V _{DET2} < 2.1V, V _{DD} = 3.6 V → 1.9 V	14	20	26	ms			
t _{VREL2}	Release Delay for VD2	V _{DET2} ≥ 2.1V, V _{DD} = 2.0 V → 3.6 V	0.7	1.2	1.7	ms	E		
		V _{DET2} < 2.1V, V _{DD} = 1.9 V → 3.6 V	0.7	1.2	1.7	ms			
V _{DET3}	Excess discharge-current threshold	Detect rising edge of 'V-' pin voltage, V _{DD} = 3.1V	V _{DET3} ≤ 0.05 V	V _{DET3}	V _{DET3} -0.005	V _{DET3} +0.005	V	F	
			0.05 V < V _{DET3} < 0.1 V		V _{DET3} × 0.9	V _{DET3} × 1.1			V
			V _{DET3} ≥ 0.1 V		V _{DET3} -0.010	V _{DET3} +0.010			V
t _{VDET3}	Output delay of excess discharge-current	V _{DD} = 3.1V, V ₋ = 0 V → [V _{SHORT} × 0.77-0.01V]	85	128	171	ms	F		
t _{VREL3}	Output delay of release from excess discharge-current	V _{DD} = 3.1V, V ₋ = 3.1V → 0V	0.7	1.2	1.7	ms	F		
V _{SHORT}	Short Protection Voltage	V _{DD} = 3.1 V	V _{SHORT} × 0.75	V _{SHORT}	V _{SHORT} × 1.25	V	F		
t _{SHORT}	Delay Time for Short Protection	V _{DD} = 3.1 V, V ₋ = 0V → 0.5V	180	250	425	μs	F		
R _{SHORT}	Reset Resistance for Excess Current Protection	V _{DD} = 3.6V, V ₋ = 1.0V	14	20.5	27	kΩ	F		

(1) Refer to TEST CIRCUITS for details.

(2) Considering of variation in process parameters, we compensate for this characteristic related to temperature by laser-trim, however, this specification is guaranteed by design, not mass production tested.

R5487LxxxSD Electrical Characteristics (Continued)

Unless otherwise provided, Ta=25°C

Symbol	Parameter	Conditions	Min.	Typ.	Max.	Unit	Circuit (1)	
V _{DET4}	Excess charge-current Threshold	Detect falling edge of 'V-' pin voltage, V _{DD} = 3.1V	V _{DET4} > -0.05V	V _{DET4} -0.005	V _{DET4}	V _{DET4} +0.005	V	G
			V _{DET4} ≤ -0.05V	V _{DET4} × 1.1		V _{DET4} × 0.9	V	
t _{VDET4}	Output delay of excess charge-current	V _{DD} = 3.1 V, V- = 0V → -1V	12	17	22	ms	G	
t _{VREL4}	Output delay of release from excess charge-current	V _{DD} = 3.1 V, V- = -1V → 0V	0.7	1.2	1.7	ms	G	
V _{DS}	Delay Time Shortening Mode Voltage	V _{DD} = 3.6 V	-2.6	-2.0	-1.4	V	G	
V _{OL1}	Nch ON-Voltage of COUT	I _{ol} = 50μA, V _{DD} = 4.8 V		0.4	0.5	V	H	
V _{OH1}	Pch ON-Voltage of COUT	I _{oh} = -50μA, V _{DD} = 3.9 V	3.4	3.7		V	I	
V _{OL2}	Nch ON-Voltage of DOUT	V _{DET2} ≥ 2.1V, I _{ol} = 50μA, V _{DD} = 2.0 V		0.2	0.5	V	J	
		V _{DET2} < 2.1V, I _{ol} = 50μA, V _{DD} = 1.9 V		0.2	0.5	V		
V _{OH2}	Pch ON-Voltage of DOUT	I _{oh} = -50μA, V _{DD} = 3.9 V	3.4	3.7		V	K	
I _{DD}	Supply Current	V _{DD} = 3.9 V, V- = 0 V		3.0	6.0	μA	L	
I _{STANDBY}	Standby Current	V _{DET2} ≥ 2.1V, V _{DD} = 2.0 V			0.5	μA	L	
		V _{DET2} < 2.1V, V _{DD} = 1.9 V			0.5	μA		

(1) Refer to TEST CIRCUITS for details.

Test Circuits

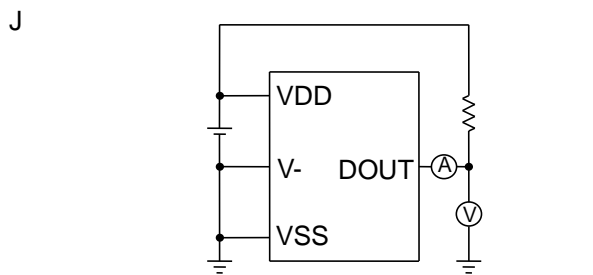
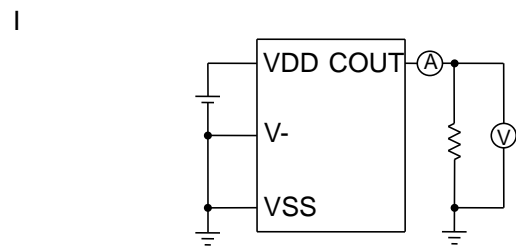
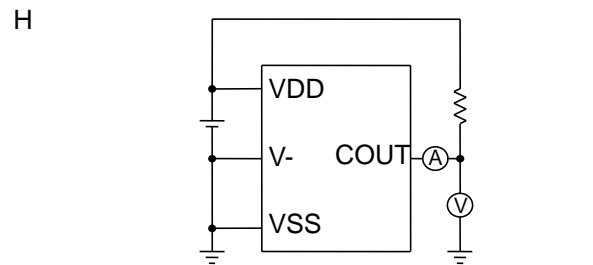
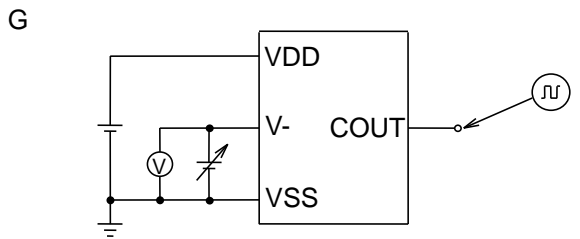
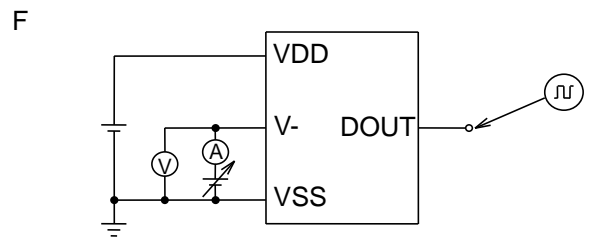
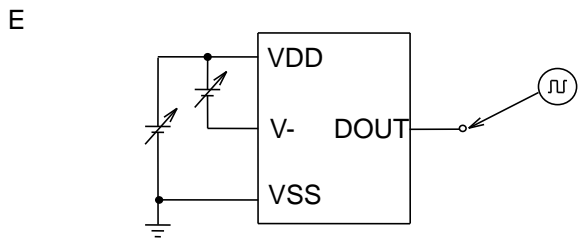
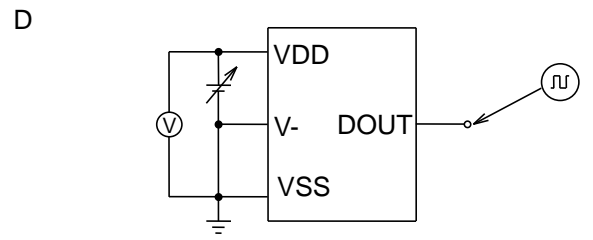
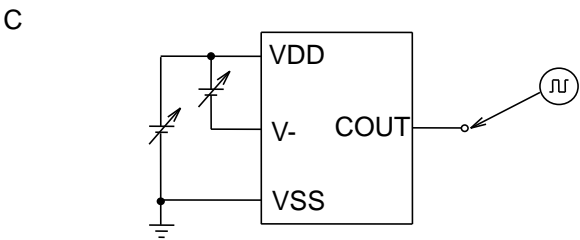
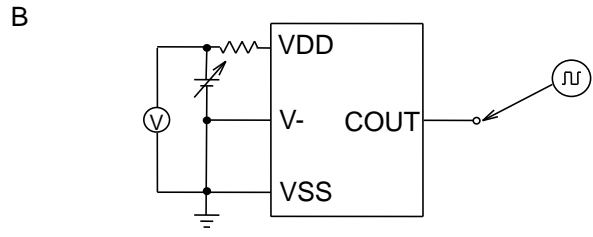
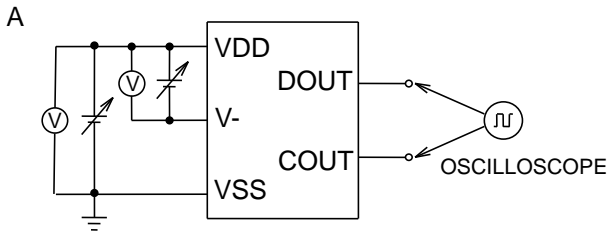

K

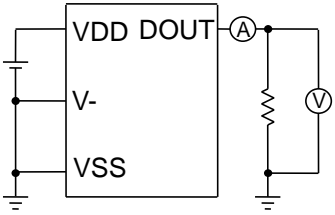

L

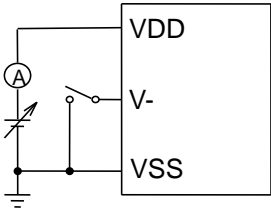

M

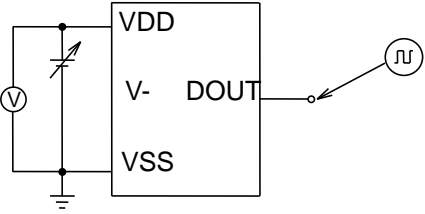

THEORY OF OPERATION

VD1 / Over-Charge Detector

The VD1 monitors V_{DD} pin voltage while charge the battery pack. When the V_{DD} voltage crosses over-charge detector threshold V_{DET1} from a low value to a value higher than the V_{DET1} , the VD1 can detect over-charge and an external charge control Nch MOSFET turn off with C_{OUT} pin being at “L” level.

In terms of “Latch type” version, to reset the VD1 making the C_{OUT} pin level to “H” again after detecting over-charge, in such conditions that a time when the V_{DD} voltage is down to a level lower than over-charge voltage, by disconnecting a charger from the battery pack. Output voltage of C_{OUT} pin becomes “H”, and it makes an external Nch MOSFET turn on, and charge cycle is available.

Depending on the external characteristics of external components such as FETs, just by disconnecting a charger, over-charge state may not be released. In such a case, by connecting some load, the over-charge state is released. In other words, once over-charge is detected, even if the supply voltage becomes low enough, if a charger is continuously connected to the battery pack, recharge is not possible. Therefore this over-charge detector has no hysteresis. To judge whether or not load is connected, the built-in excess-discharge current detector is used. In other words, by connecting some load, V- pin voltage becomes equal or more than excess-discharge current detector threshold, and reset the over-charge detecting state.

In terms of “Auto Release type” version, after detecting over-charge, if V_{DD} pin voltage is equal or lower than the released voltage from over-charge, even if a charger is connected, over-charge detector is released. Further, in case that V_{DD} pin level is lower than the over-charge detector threshold, if a charger is removed, over-charge detector is also released. Depending on the characteristics of external components such as FETs, just by disconnecting a charger, over-charge detector may not be released, and in this case, by connecting some load, the over-charge state is released.

After detecting over-charge with the V_{DD} voltage of higher than V_{DET1} , connecting system load to the battery pack makes load current allowable through parasitic diode of external charge control FET.

The C_{OUT} level would be “H” when the V_{DD} level is down to a level below the V_{DET1} by continuous drawing of load current.

Internal fixed output delay times for over-charge detection and release from over-charge exist. Even when the V_{DD} pin level becomes equal or higher level than V_{DET1} if the V_{DD} voltage would be back to a level lower than the V_{DET1} within a time period of the output delay time, VD1 would not output a signal for turning off the charge control FET. Besides, after detecting over-charge, while the V_{DD} is lower than over-charge detector, even if a charger is removed and a load is connected, if the voltage is recovered within output delay time of release from over-charge, over-charge state is not released.

A level shifter incorporated in a buffer driver for the C_{OUT} pin makes the “L” level of C_{OUT} pin to the V- pin voltage and the “H” level of C_{OUT} pin is set to V_{DD} voltage with CMOS buffer.

VD2 / Over-Discharge Detector

The VD2 is monitoring a V_{DD} pin voltage. When the V_{DD} voltage crosses the over-discharge detector threshold V_{DET2} from a high value to a value lower than the V_{DET2} , the VD2 can detect an over-discharge and the external discharge control Nch MOSFET turns off with the D_{OUT} pin being at “L” level.

In terms of “Latch type” version, to reset the VD2 with the D_{OUT} pin level being “H” again after detecting over discharge, it is necessary to connect a charger to the battery pack. When the V_{DD} voltage stays under over-discharge detector threshold V_{DET2} , charge-current can flow through parasitic diode of an external discharge control MOSFET, then after the V_{DD} voltage comes up to a value larger than V_{DET2} , then, D_{OUT} becomes “H” and discharging process would be able to advance through ON state MOSFET for discharge control.

Connecting a charger to the battery pack makes the D_{OUT} level being “H” instantaneously when the V_{DD} voltage is higher than V_{DET2}.

In terms of “Auto Release type” version, released operation by connecting a charger is same as the other latch type. However, without a charger, if V_{DD} pin voltage is equal or more than the released voltage from over-discharge, D_{OUT} pin becomes “H” immediately.

When a cell voltage equals to zero, “acceptable type” version: if the voltage of a charger is equal or more than 0V-charge minimum voltage limit (V_{st}), C_{OUT} pin becomes “H” and a system is allowable to charge.

“Unacceptable type” version: if V_{DD} voltage is less than charger inhibit maximum voltage (V_{nochg}), even if a charger is connected, C_{OUT} level will be fixed at “L”, and charge current will be cut off.

An output delay time for over-discharge detection is fixed internally. When the V_{DD} level is down to equal or lower level than V_{DET2} if the V_{DD} voltage would be back to a level higher than the V_{DET2} within a time period of the output delay time, VD2 would not output a signal for turning off the discharge control FET. Output delay time for release from over-discharge is also set.

After detecting over-discharge by VD2, “Latch type” version: supply current would be reduced and be into standby by halting unnecessary circuits and consumption current of IC itself is made as small as possible. (Max. 0.1μA at V_{DD}=2.0V)

“Auto Release type” version: supply current would be reduced and be into standby by halting circuits except the over-discharge released by voltage function. (Max. 0.5μA at V_{DD}=2.0V)

The output type of D_{OUT} pin is CMOS having “H” level of V_{DD} and “L” level of V_{SS}.

VD3 /Excess discharge-current Detector, Short Circuit Protector

Both of the excess current detector and short circuit protection can work when the both of control FETs are in “ON” state.

When the V- pin voltage is up to a value between the short protection voltage V_{short} and excess discharge-current threshold V_{DET3}, VD3 operates and further soaring of V- pin voltage higher than V_{short} makes the short circuit protector enabled. This leads the external discharge control Nch MOSFET turns off with the D_{OUT} pin being at “L” level. An output delay time for the excess discharge-current detector is internally fixed. A quick recovery of V- pin level from a value between V_{short} and V_{DET3} within the delay time keeps the discharge control FET staying “H” state. Output delay time for Release from excess discharge-current detection is also set.

When the short circuit protector is enabled, the D_{OUT} would be “L” and the delay time to release (Typ. 1.2ms) is also set.

The V- pin has a built-in pull-down resistor (R_{short}) to the V_{SS} pin, that is, the resistance to release from excess-discharge current.

After an excess discharge-current or short circuit protection is detected, removing a cause of excess discharge-current or external short circuit makes an external discharge control FET to an “ON” state automatically with the V- pin level being down to the V_{SS} level through built-in pulled down resistor. The reset resistor of excess discharge-current is off at normal state. Only when detecting excess discharge-current or short circuit, the resistor is on.

Output delay time of excess discharge-current is set shorter than the delay time for over-discharge detector. Therefore, if V_{DD} voltage would be lower than V_{DET2} at the same time as the excess discharge-current is detected, the R5487 are at excess discharge-current detection mode. By disconnecting a load, VD3 is automatically released from excess discharge-current.

VD4 /Excess charge-current detector

When the battery pack is chargeable and discharge is also possible, VD4 senses V- pin voltage. For example, in case that a battery pack is charged by an inappropriate charger, an excess current flows, then the voltage of V- pin becomes equal or less than excess charge-current detector threshold. Then, the output of C_{OUT} becomes "L", and prevents from flowing excess current in the circuit by turning off the external Nch MOSFET. Output delay of excess charge current is internally fixed. Even the voltage level of V- pin becomes equal or lower than the excess charge-current detector threshold, the voltage is higher than the VD4 threshold within the delay time, and the excess charge current is not detected. Output delay for the release from excess charge current (Typ. 1.2ms) is also set.

VD4 can be released with disconnecting a charger and connecting a load.

DS (Delay Shorten) function

Output delay time of over-charge and over-discharge can be shorter than those setting value by forcing equal or less than the delay shortening mode voltage (Typ. -2.0V) to V- pin.

TIMING CHART

5) Timing diagram of over-charge (Latch type) voltage and over-charge current

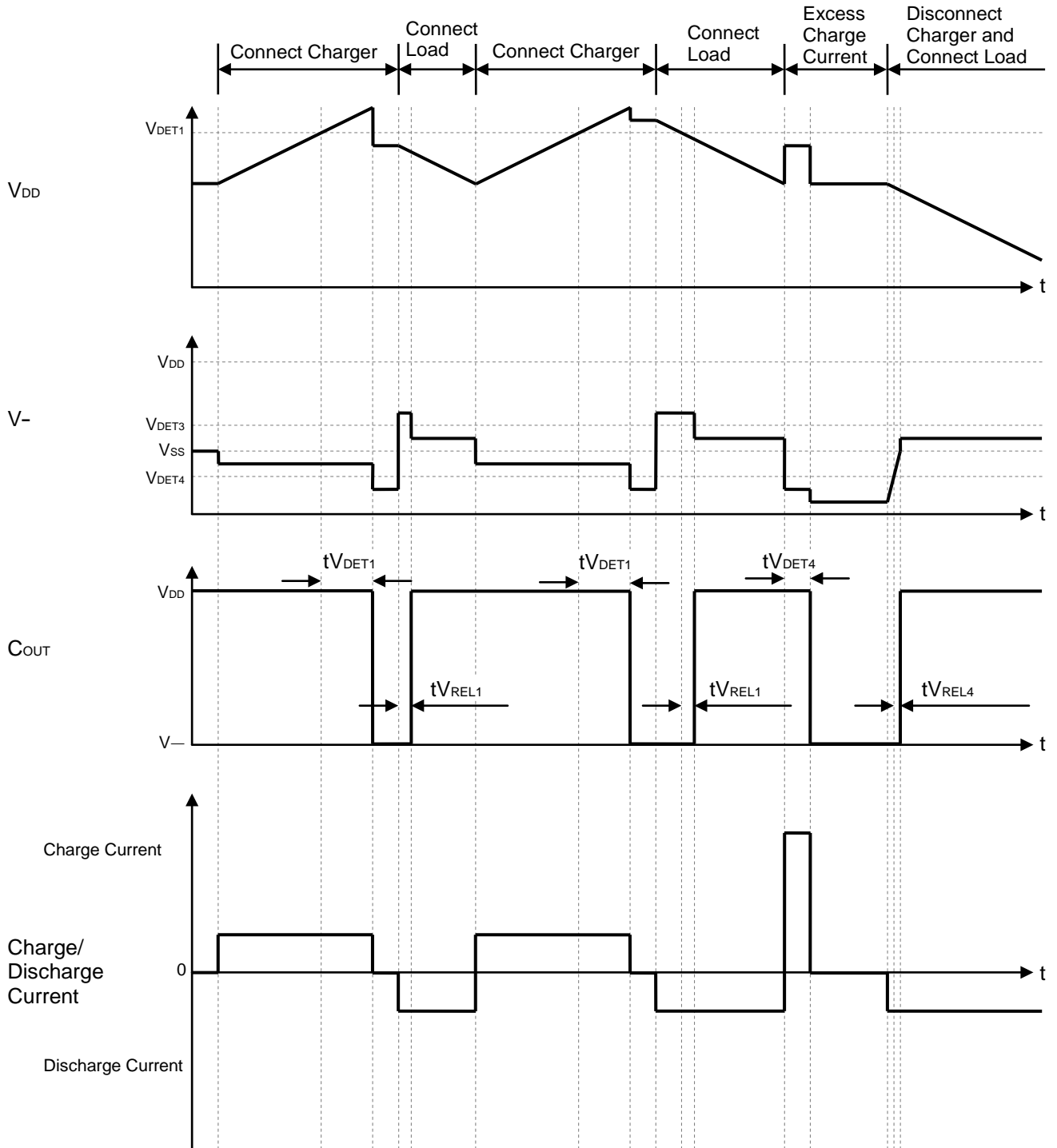

2) Over-charge (Released by voltage Type) voltage, Excess charge current Operation

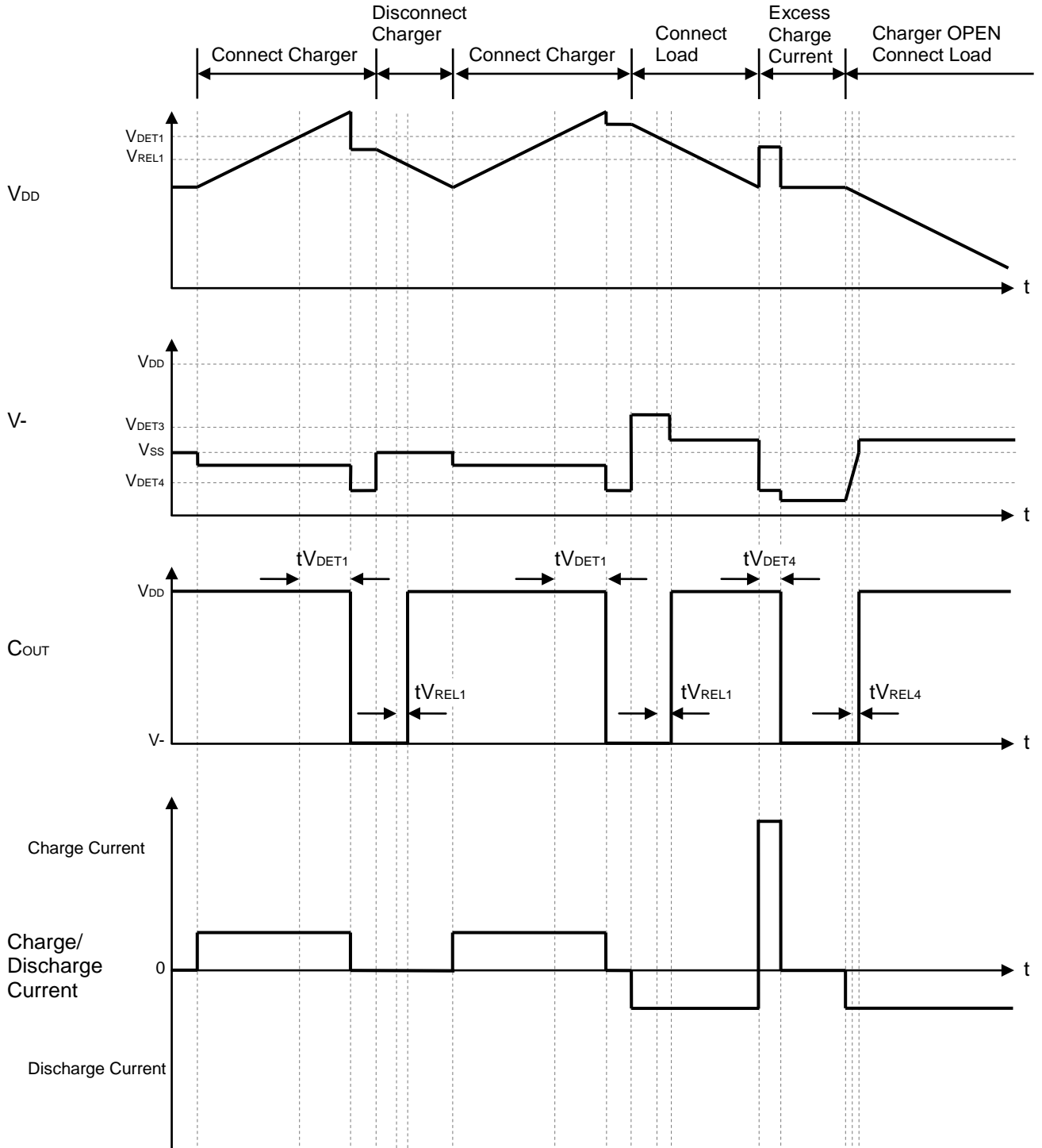

3) Over-discharge (Latch Type), Excess discharge current, Short circuit

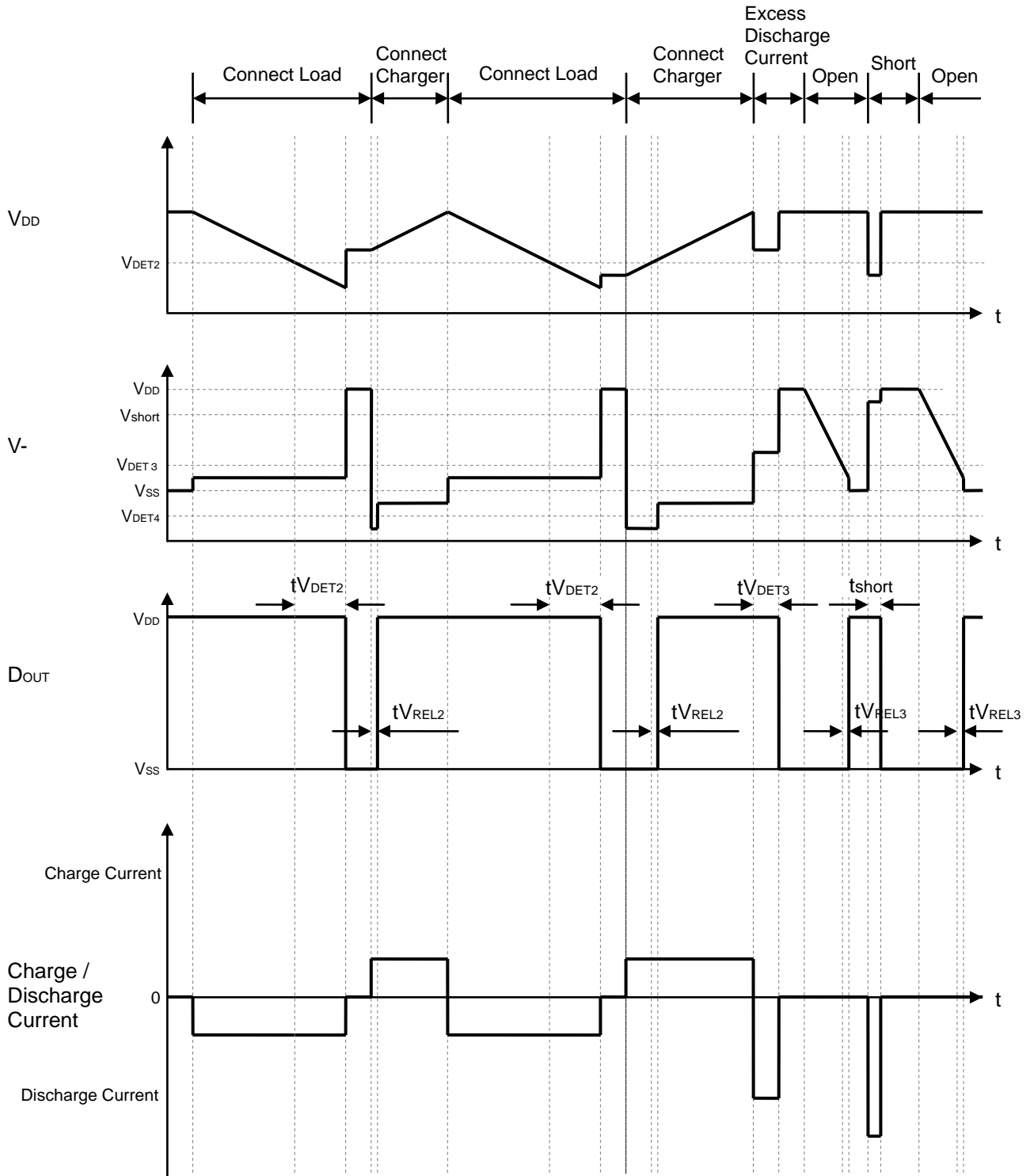

4) Over-discharge (Released by Voltage Type), Excess discharge current (Auto-Release Type 1), Short circuit

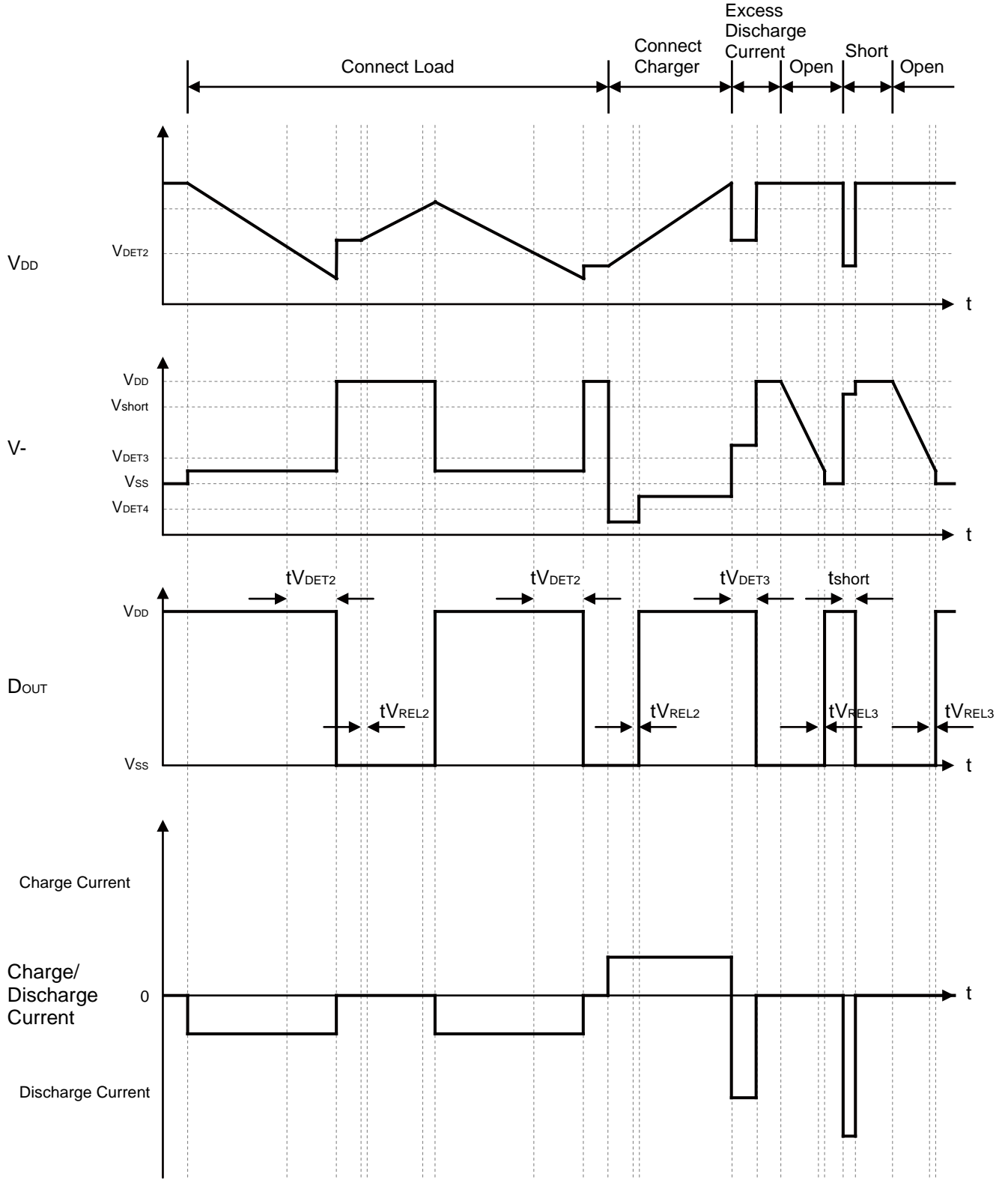

5) Over-discharge (Released by Voltage Type), Excess discharge current (Auto Release Type 2), Short circuit

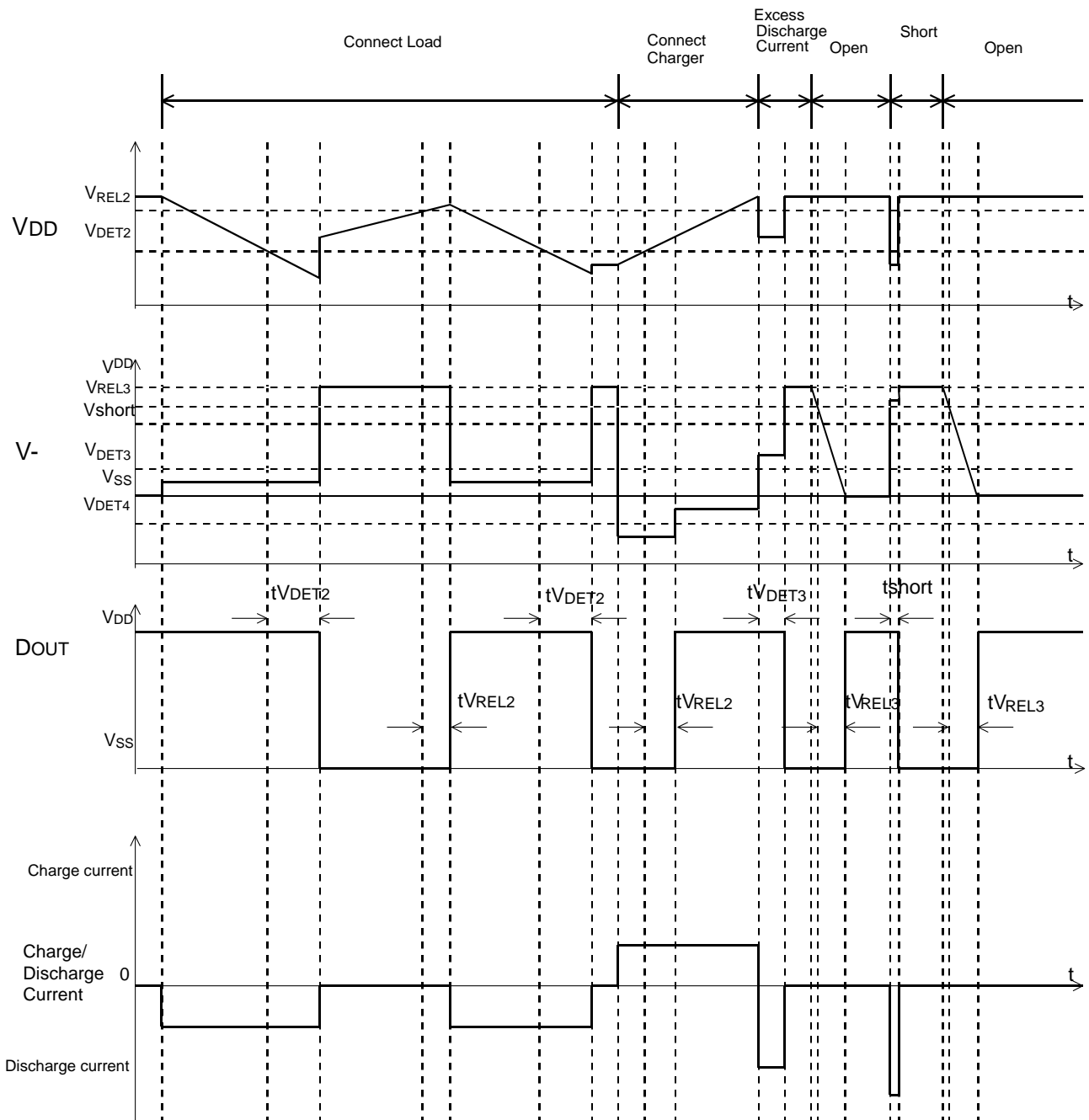

APPLICATION INFORMATION

Typical Application Circuit

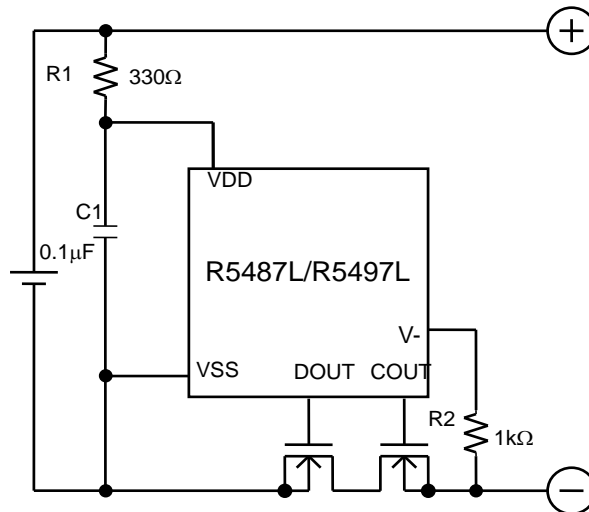

R1 and C1 stabilize a supply voltage to the R5487L/R5497L. A recommended R1 value is equal or less than 1kΩ. A large value of R1 makes detection voltage shift higher because of the conduction current flowed in the R5487L/R5497L. Further, to stabilize the operation of the R5487L/R5497L, use the C1 with the value in the range from 0.01Uf to 0.1Uf. To choose the most suitable value of C1, fully evaluation is necessary.

R1 and R2 can operate also as parts for current limit circuit against reverse charge or applying a charger with excess charging voltage to the R5487, battery pack. While small value of R1 and R2 may cause over power dissipation rating of the R5487L/R5497L, therefore a total of "R1+R2" should be 1kΩ or more. Besides, if a large value of R2 is set, release from over-discharge by connecting a charger might not be possible.

In the case of "R5487L/R5497Lxxx\$M", "R5487L/R5497Lxxx\$Q", "R5487L/R5497Lxxx\$P", "k", recommended R2 value is equal or less than 1kΩ. The recommended R2 value is 1KΩ. In the case of "R5487L/R5497Lxxx\$D" and "R5487L/R5497Lxxx\$F", recommended R2 value is equal or less than 10kΩ. The recommended R2 value is 10KΩ.

The typical application circuit diagram is just an example. This circuit performance largely depends on the PCB layout and external components. In the actual application, fully evaluation is necessary.

Over-voltage and the over current beyond the absolute maximum rating should not be forced to the protection IC and external components. If the positive terminal and the negative terminal of the battery pack are short, even though the short protection circuit is built in the IC, during the delay time until detecting the short circuit, a large current may flow through the FET. Select an FET with large enough current capacity in order to endure the large current during the delay time.

We are making our continuous effort to improve the quality and reliability of our products, but semiconductor products are likely to fail with certain probability. In order prevent any injury to persons or damages to property resulting from such failure, customers should be careful enough to incorporate safety measures in their design, such as redundancy feature, fire-containment feature and fail-safe feature. We do not assume any liability or responsibility for any loss or damage arising from misuse or inappropriate use of the products.

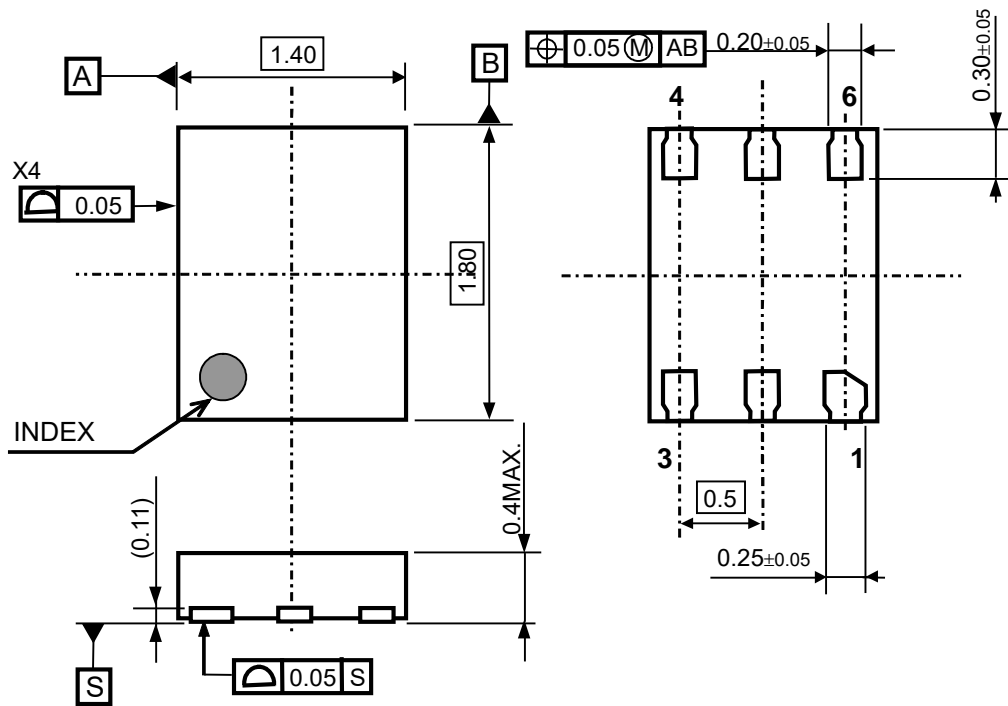

DFN1814-6B Package Dimensions (Unit: mm)



1. The products and the product specifications described in this document are subject to change or discontinuation of production without notice for reasons such as improvement. Therefore, before deciding to use the products, please refer to Ricoh sales representatives for the latest information thereon.
2. The materials in this document may not be copied or otherwise reproduced in whole or in part without prior written consent of Ricoh.
3. Please be sure to take any necessary formalities under relevant laws or regulations before exporting or otherwise taking out of your country the products or the technical information described herein.
4. The technical information described in this document shows typical characteristics of and example application circuits for the products. The release of such information is not to be construed as a warranty of or a grant of license under Ricoh's or any third party's intellectual property rights or any other rights.
5. The products listed in this document are intended and designed for use as general electronic components in standard applications (office equipment, telecommunication equipment, measuring instruments, consumer electronic products, amusement equipment etc.). Those customers intending to use a product in an application requiring extreme quality and reliability, for example, in a highly specific application where the failure or misoperation of the product could result in human injury or death (aircraft, spacevehicle, nuclear reactor control system, traffic control system, automotive and transportation equipment, combustion equipment, safety devices, life support system etc.) should first contact us.
6. We are making our continuous effort to improve the quality and reliability of our products, but semiconductor products are likely to fail with certain probability. In order to prevent any injury to persons or damages to property resulting from such failure, customers should be careful enough to incorporate safety measures in their design, such as redundancy feature, fire containment feature and fail-safe feature. We do not assume any liability or responsibility for any loss or damage arising from misuse or inappropriate use of the products.
7. Anti-radiation design is not implemented in the products described in this document.
8. The X-ray exposure can influence functions and characteristics of the products. Confirm the product functions and characteristics in the evaluation stage.
9. WLCSP products should be used in light shielded environments. The light exposure can influence functions and characteristics of the products under operation or storage.
10. There can be variation in the marking when different AOI (Automated Optical Inspection) equipment is used. In the case of recognizing the marking characteristic with AOI, please contact Ricoh sales or our distributor before attempting to use AOI.
11. Please contact Ricoh sales representatives should you have any questions or comments concerning the products or the technical information.



Ricoh is committed to reducing the environmental loading materials in electrical devices with a view to contributing to the protection of human health and the environment.

Ricoh has been providing RoHS compliant products since April 1, 2006 and Halogen-free products since April 1, 2012.

RICOH RICOH ELECTRONIC DEVICES CO., LTD.

Official website

<https://www.e-devices.ricoh.co.jp/en/>

Contact us

<https://www.e-devices.ricoh.co.jp/en/support/>

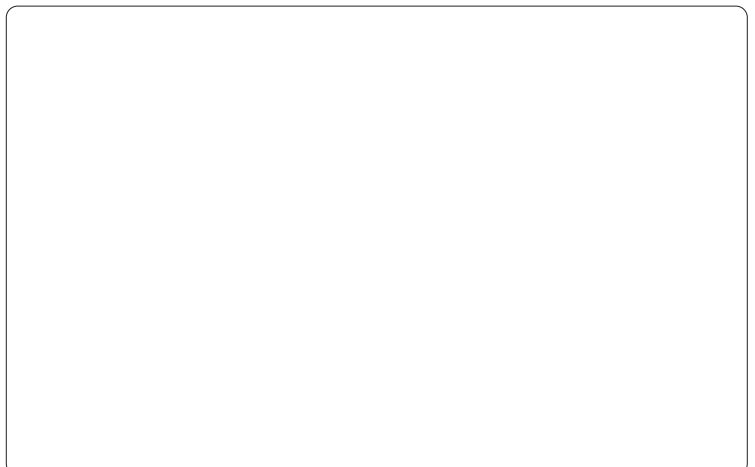

X-ON Electronics

Largest Supplier of Electrical and Electronic Components

Click to view similar products for [Battery Management](#) category:

Click to view products by [Nisshinbo](#) manufacturer:

Other Similar products are found below :

[MP26121DQ-LF-P](#) [NCP1855FCCT1G](#) [FAN54063UCX](#) [LC05132C01NMTTTG](#) [SN2040DSQR](#) [ME4075AM5G](#) [AP5054HTCER](#) [TC2120-NB](#) [XPD977B](#) [XPD977B18](#) [4056H](#) [DW01](#) [DW06](#) [CM1002-UD](#) [CM1002-W](#) [CM1002-X](#) [CM1002-Y](#) [CM1006-B](#) [CM1006-Q](#) [CM1006-WB](#) [CM1006-LCD](#) [CM1006-LBD](#) [CM1006-WF](#) [CM1006-LF](#) [CM1006-WG](#) [CM1006-WH](#) [CM1006-LG](#) [CM1003-S02BD](#) [CM1003-S09EA](#) [CM1003-S10ED](#) [CM1003-S11ED](#) [CM1003-S12BC](#) [CM1003-S13CC](#) [CM1003-S24BC](#) [CM1003-S26BC](#) [CM1003-WAD](#) [CM1003-BBD](#) [CM1003-BFD](#) [CM1003-BND](#) [CM1003-BLD](#) [CM1003-DAD](#) [CM1003-BMD](#) [CM1003-BPD](#) [CM1003-BKD](#) [CM1003-BAE](#) [CM1003-BHE](#) [CM1102B-FF](#) [CM1102B-FD](#) [CM1102B-GD](#) [CM1112-DAE](#)