

---

## VOLTAGE REGULATOR

---

NO. EA-016-130402

### OUTLINE

The Rx5RE Series are CMOS-based voltage regulator ICs with high output voltage accuracy and ultra-low quiescent current. Each of these ICs consists of a voltage reference unit, an error amplifier, a driver transistor, and resistors for setting output voltage, and a current limit circuit. By use of these ICs, a constant voltage power supply circuit with high efficiency can be constructed because the dropout voltage and quiescent current of these ICs are very small. Furthermore, these ICs have a built-in current limit circuit. The output voltage of these ICs is fixed with high accuracy.

Two types of packages, TO-92 (**Discontinued**) and SOT-89 (Mini-power Mold) are available.

### FEATURES

- Supply Current ..... Typ. 1.1 $\mu$ A ( $V_{OUT}=3.0V$ ,  $V_{IN}=5.0V$ )
- Dropout Voltage ..... Typ. 0.5V ( $I_{OUT}=60mA$ ,  $V_{OUT}=2.8V$ )
- Output Current ..... Typ. 120mA ( $V_{OUT}=5.0V$ )
- Input Voltage Range ..... Max. 10.0V
- Output Voltage Range..... 2.0V to 6.0V (0.1V steps)  
(For other voltages, please refer to MARK INFORMATIONS.)
- Output Voltage Accuracy.....  $\pm 2.5\%$
- Temperature-Drift Coefficient of Output Voltage ..... Typ.  $\pm 100ppm/^{\circ}C$
- Line Regulation ..... Typ. 0.1%/V
- Packages ..... SOT-89 (Mini-power Mold), TO-92 (**Discontinued**)

### APPLICATIONS

- Power source for battery-powered equipment
- Power source for cameras, video instruments such as camcorders, VCRs, and hand-held communication equipment
- Precision voltage references

## BLOCK DIAGRAMS

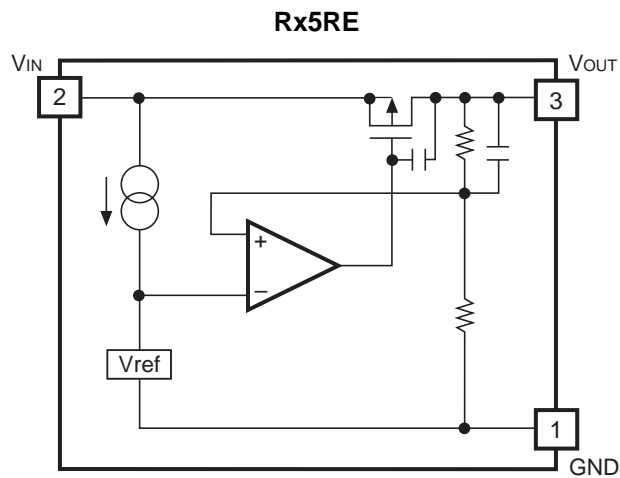

## SELECTION GUIDE

The output voltage and package for the ICs can be selected at the user's request.

Product Name	Package	Quantity per Reel	Pb Free	Halogen Free
RH5RExxAA-T1-FE	SOT-89	1,000 pcs	Yes	Yes
RE5RExxAA-TZ-F	TO-92 ( <b>Discontinued</b> )	2,500 pcs	Yes	No

xx: The output voltage can be designated in the range from 2.0V (20) to 6.0V (60) in 0.1V steps.  
(For other voltages, please refer to MARK INFORMATIONS.)

## PIN CONFIGURATION

- SOT-89

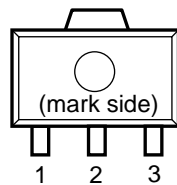

- TO-92

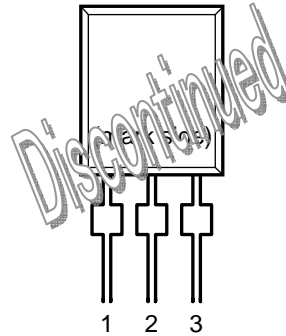

## PIN DESCRIPTION

- SOT-89

Pin No	Symbol	Pin Description
1	GND	Ground Pin
2	$V_{IN}$	Input Pin
3	$V_{OUT}$	Output Pin

- TO-92 (Discontinued)

Pin No	Symbol	Pin Description
1	GND	Ground Pin
2	$V_{IN}$	Input Pin
3	$V_{OUT}$	Output Pin

## ABSOLUTE MAXIMUM RATINGS

Symbol	Item	Rating	Unit
$V_{IN}$	Input Voltage	12	V
$V_{OUT}$	Output Voltage	-0.3 to $V_{IN}+0.3$	V
$I_{OUT}$	Output Current	300	mA
$P_D$	Power Dissipation* (SOT-89)	900	mW
	Power Dissipation* (TO-92) (Discontinued)	300	
$T_{opt}$	Operating Temperature Range	-40 to 85	°C
$T_{stg}$	Storage Temperature Range	-55 to 125	°C
$T_{solder}$	Lead Temperature (Soldering)	260°C, 10s	

\*) For Power Dissipation, please refer to PACKAGE INFORMATION.

### ABSOLUTE MAXIMUM RATINGS

Electronic and mechanical stress momentarily exceeded absolute maximum ratings may cause the permanent damages and may degrade the life time and safety for both device and system using the device in the field.

The functional operation at or over these absolute maximum ratings is not assured.

### RECOMMENDED OPERATING CONDITIONS (ELECTRICAL CHARACTERISTICS)

All of electronic equipment should be designed that the mounted semiconductor devices operate within the recommended operating conditions. The semiconductor devices cannot operate normally over the recommended operating conditions, even if when they are used over such conditions by momentary electronic noise or surge. And the semiconductor devices may receive serious damage when they continue to operate over the recommended operating conditions.

## ELECTRICAL CHARACTERISTICS

### • Rx5RE20A

T<sub>opt</sub>=25°C

Symbol	Item	Conditions	Min.	Typ.	Max.	Unit
V <sub>OUT</sub>	Output Voltage	V <sub>IN</sub> =4.0V, I <sub>OUT</sub> =10mA	1.950	2.000	2.050	V
I <sub>OUT</sub>	Output Current	V <sub>IN</sub> =4.0V	40	60		mA
$\frac{\Delta V_{OUT}}{\Delta I_{OUT}}$	Load Regulation	V <sub>IN</sub> =4.0V 1mA ≤ I <sub>OUT</sub> ≤ 50mA		40	80	mV
V <sub>DIF</sub>	Dropout Voltage	I <sub>OUT</sub> =30mA		0.5	0.7	V
I <sub>SS</sub>	Quiescent Current	V <sub>IN</sub> =4.0V		1.0	3.0	μA
$\frac{\Delta V_{OUT}}{\Delta V_{IN}}$	Line Regulation	I <sub>OUT</sub> =10mA V <sub>OUT</sub> +1.0V ≤ V <sub>IN</sub> ≤ 10V		0.1		%/V
V <sub>IN</sub>	Input Voltage				10	V
I <sub>lim</sub>	Current Limit			240		mA
$\frac{\Delta V_{OUT}}{\Delta T_{opt}}$	Output Voltage Temperature Coefficient	I <sub>OUT</sub> =10mA -40°C ≤ T <sub>opt</sub> ≤ 85°C		±100		ppm/°C

### • Rx5RE30A

T<sub>opt</sub>=25°C

Symbol	Item	Conditions	Min.	Typ.	Max.	Unit
V <sub>OUT</sub>	Output Voltage	V <sub>IN</sub> =5.0V, I <sub>OUT</sub> =10mA	2.925	3.000	3.075	V
I <sub>OUT</sub>	Output Current	V <sub>IN</sub> =5.0V	50	80		mA
$\frac{\Delta V_{OUT}}{\Delta I_{OUT}}$	Load Regulation	V <sub>IN</sub> =5.0V 1mA ≤ I <sub>OUT</sub> ≤ 60mA		40	80	mV
V <sub>DIF</sub>	Dropout Voltage	I <sub>OUT</sub> =40mA		0.5	0.7	V
I <sub>SS</sub>	Quiescent Current	V <sub>IN</sub> =5.0V		1.1	3.3	μA
$\frac{\Delta V_{OUT}}{\Delta V_{IN}}$	Line Regulation	I <sub>OUT</sub> =10mA V <sub>OUT</sub> +1.0V ≤ V <sub>IN</sub> ≤ 10V		0.1		%/V
V <sub>IN</sub>	Input Voltage				10	V
I <sub>lim</sub>	Current Limit			240		mA
$\frac{\Delta V_{OUT}}{\Delta T_{opt}}$	Output Voltage Temperature Coefficient	I <sub>OUT</sub> =10mA -40°C ≤ T <sub>opt</sub> ≤ 85°C		±100		ppm/°C

## Rx5RE

### • Rx5RE40A

T<sub>opt</sub>=25°C

Symbol	Item	Conditions	Min.	Typ.	Max.	Unit
V <sub>OUT</sub>	Output Voltage	V <sub>IN</sub> =6.0V, I <sub>OUT</sub> =10mA	3.900	4.000	4.100	V
I <sub>OUT</sub>	Output Current	V <sub>IN</sub> =6.0V	65	100		mA
$\frac{\Delta V_{OUT}}{\Delta I_{OUT}}$	Load Regulation	V <sub>IN</sub> =6.0V 1mA ≤ I <sub>OUT</sub> ≤ 70mA		40	80	mV
V <sub>DIF</sub>	Dropout Voltage	I <sub>OUT</sub> =50mA		0.5	0.7	V
I <sub>SS</sub>	Quiescent Current	V <sub>IN</sub> =6.0V		1.2	3.6	μA
$\frac{\Delta V_{OUT}}{\Delta V_{IN}}$	Line Regulation	I <sub>OUT</sub> =10mA V <sub>OUT</sub> +1.0V ≤ V <sub>IN</sub> ≤ 10V		0.1		%/V
V <sub>IN</sub>	Input Voltage				10	V
I <sub>lim</sub>	Current Limit			240		mA
$\frac{\Delta V_{OUT}}{\Delta T_{opt}}$	Output Voltage Temperature Coefficient	I <sub>OUT</sub> =10mA -40°C ≤ T <sub>opt</sub> ≤ 85°C		±100		ppm/°C

### • Rx5RE50A

T<sub>opt</sub>=25°C

Symbol	Item	Conditions	Min.	Typ.	Max.	Unit
V <sub>OUT</sub>	Output Voltage	V <sub>IN</sub> =7.0V, I <sub>OUT</sub> =10mA	4.875	5.000	5.125	V
I <sub>OUT</sub>	Output Current	V <sub>IN</sub> =7.0V	80	120		mA
$\frac{\Delta V_{OUT}}{\Delta I_{OUT}}$	Load Regulation	V <sub>IN</sub> =7.0V 1mA ≤ I <sub>OUT</sub> ≤ 80mA		40	80	mV
V <sub>DIF</sub>	Dropout Voltage	I <sub>OUT</sub> =60mA		0.5	0.7	V
I <sub>SS</sub>	Quiescent Current	V <sub>IN</sub> =7.0V		1.3	3.9	μA
$\frac{\Delta V_{OUT}}{\Delta V_{IN}}$	Line Regulation	I <sub>OUT</sub> =10mA V <sub>OUT</sub> +1.0V ≤ V <sub>IN</sub> ≤ 10V		0.1		%/V
V <sub>IN</sub>	Input Voltage				10	V
I <sub>lim</sub>	Current Limit			240		mA
$\frac{\Delta V_{OUT}}{\Delta T_{opt}}$	Output Voltage Temperature Coefficient	I <sub>OUT</sub> =10mA -40°C ≤ T <sub>opt</sub> ≤ 85°C		±100		ppm/°C

## • Rx5RE60A

T<sub>opt</sub>=25°C

Symbol	Item	Conditions	Min.	Typ.	Max.	Unit
V <sub>OUT</sub>	Output Voltage	V <sub>IN</sub> =8.0V, I <sub>OUT</sub> =10mA	5.850	6.000	6.150	V
I <sub>OUT</sub>	Output Current	V <sub>IN</sub> =8.0V	80	120		mA
$\frac{\Delta V_{OUT}}{\Delta I_{OUT}}$	Load Regulation	V <sub>IN</sub> =8.0V 1mA ≤ I <sub>OUT</sub> ≤ 80mA		40	80	mV
V <sub>DIF</sub>	Dropout Voltage	I <sub>OUT</sub> =60mA		0.5	0.7	V
I <sub>SS</sub>	Quiescent Current	V <sub>IN</sub> =8.0V		1.4	4.2	μA
$\frac{\Delta V_{OUT}}{\Delta V_{IN}}$	Line Regulation	I <sub>OUT</sub> =10mA V <sub>OUT</sub> +1.0V ≤ V <sub>IN</sub> ≤ 10V		0.1		%/V
V <sub>IN</sub>	Input Voltage				10	V
I <sub>lim</sub>	Current Limit			240		mA
$\frac{\Delta V_{OUT}}{\Delta T_{opt}}$	Output Voltage Temperature Coefficient	I <sub>OUT</sub> =10mA -40°C ≤ T <sub>opt</sub> ≤ 85°C		±100		ppm/°C

## ELECTRICAL CHARACTERISTICS BY OUTPUT VOLTAGE

Part Number	Output Voltage				Output Current			Load Regulation			Dropout Voltage		
	V <sub>OUT</sub> (V)				I <sub>OUT</sub> (mA)			ΔV <sub>OUT</sub> /ΔI <sub>OUT</sub> (mV)			V <sub>DIF</sub> (V)		
	Conditions	Min.	Typ.	Max.	Conditions	Min.	Typ.	Conditions	Typ.	Max.	Conditions	Typ.	Max.
Rx5RE20A	V <sub>IN</sub> - V <sub>OUT</sub> =2.0V  I <sub>OUT</sub> =10mA	1.950	2.000	2.050	V <sub>IN</sub> - V <sub>OUT</sub> =2.0V	40	60	V <sub>IN</sub> - V <sub>OUT</sub> =2.0V	40	80	0.5	0.7	I <sub>OUT</sub> =30mA
Rx5RE21A		2.048	2.100	2.152									
Rx5RE22A		2.145	2.200	2.255									
Rx5RE23A		2.243	2.300	2.357									
Rx5RE24A		2.340	2.400	2.460									
Rx5RE25A		2.438	2.500	2.562									
Rx5RE26A		2.535	2.600	2.665									
Rx5RE27A		2.633	2.700	2.767									
Rx5RE28A		2.730	2.800	2.870									
Rx5RE29A		2.828	2.900	2.972									
Rx5RE30A		2.925	3.000	3.075									
Rx5RE31A		3.023	3.100	3.177									
Rx5RE32A		3.120	3.200	3.280									
Rx5RE33A		3.218	3.300	3.382									
Rx5RE34A		3.315	3.400	3.485									
Rx5RE35A		3.413	3.500	3.587									
Rx5RE36A		3.510	3.600	3.690									
Rx5RE37A		3.608	3.700	3.792									
Rx5RE38A		3.705	3.800	3.895									
Rx5RE39A		3.803	3.900	3.997									
Rx5RE40A		3.900	4.000	4.100									
Rx5RE41A		3.998	4.100	4.202									
Rx5RE42A		4.095	4.200	4.305									
Rx5RE43A		4.193	4.300	4.407									
Rx5RE44A		4.290	4.400	4.510									
Rx5RE45A		4.388	4.500	4.612									
Rx5RE46A		4.485	4.600	4.715									
Rx5RE47A		4.583	4.700	4.817									
Rx5RE48A		4.680	4.800	4.920									
Rx5RE49A		4.778	4.900	5.022									
Rx5RE50A	4.875	5.000	5.125										
Rx5RE51A	4.973	5.100	5.227										
Rx5RE52A	5.070	5.200	5.330										
Rx5RE53A	5.168	5.300	5.432										
Rx5RE54A	5.265	5.400	5.535										
Rx5RE55A	5.363	5.500	5.637										
Rx5RE56A	5.460	5.600	5.740										
Rx5RE57A	5.558	5.700	5.842										
Rx5RE58A	5.655	5.800	5.945										
Rx5RE59A	5.753	5.900	6.047										
Rx5RE60A	5.850	6.000	6.150										



T<sub>opt</sub>=25°C

Quiescent Current			Line Regulation		Input Voltage	Current Limit	Output Voltage Tempco.	
I <sub>ss</sub> (μA)			ΔV <sub>OUT</sub> /ΔV <sub>IN</sub> (%/V)		V <sub>IN</sub> (V)	I <sub>lim</sub> (mA)	ΔV <sub>OUT</sub> /ΔT(ppm/°C)	
Conditions	Typ.	Max.	Conditions	Typ.	Max.	Typ.	Conditions	Typ.
V <sub>IN</sub> - V <sub>OUT</sub> =2.0V	1.0	3.0	I <sub>OUT</sub> =10mA  V <sub>OUT</sub> + 1.0V≤ V <sub>IN</sub> ≤10V	0.1	10	240	I <sub>OUT</sub> =10mA  -40°C≤ T <sub>opt</sub> ≤85°C	±100
	1.1	3.3						
	1.2	3.6						
	1.3	3.9						
	1.4	4.2						

## OPERATION

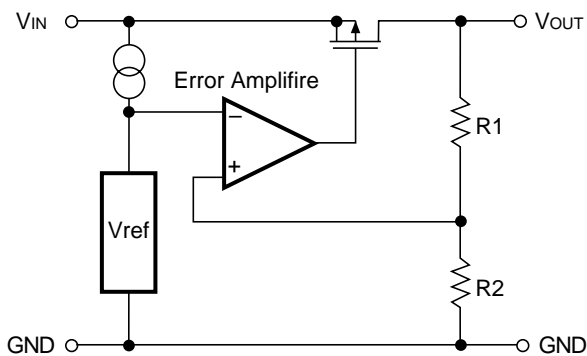

FIG. 1 Block Diagram

Output voltage  $V_{OUT}$  divided at the node between resistors  $R1$  and  $R2$  is compared with reference voltage by error amplifier, so that a constant voltage is output.

## TEST CIRCUITS

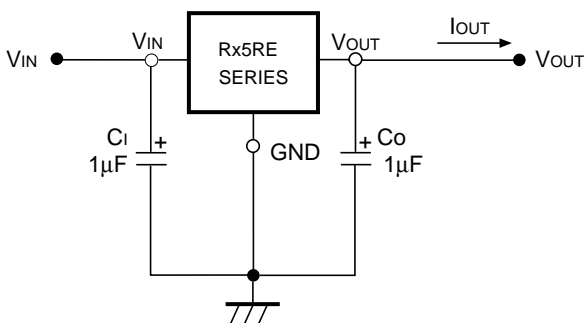

FIG. 2 Test Circuit

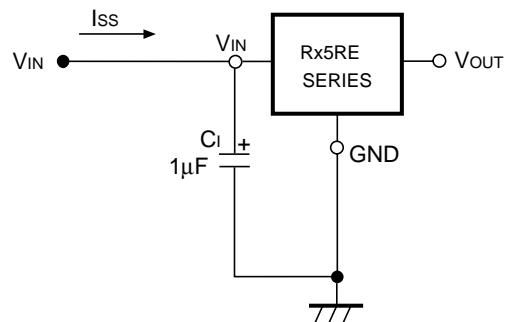

FIG. 3 Quiescent Current Test Circuit

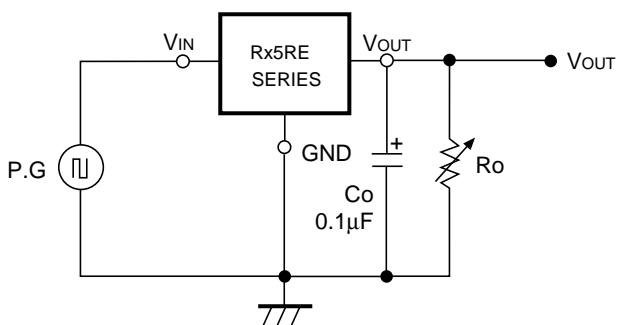
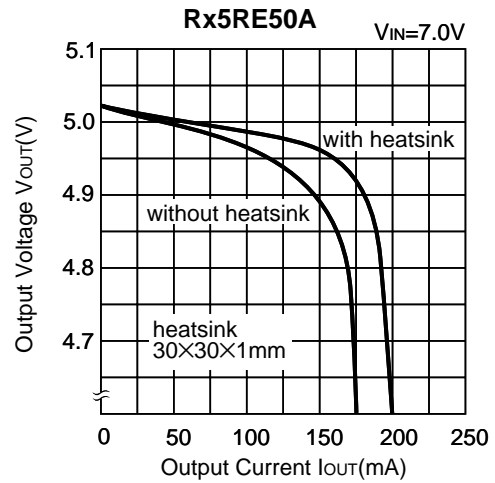
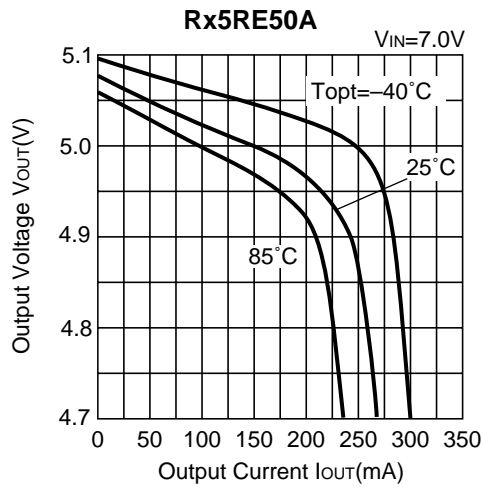
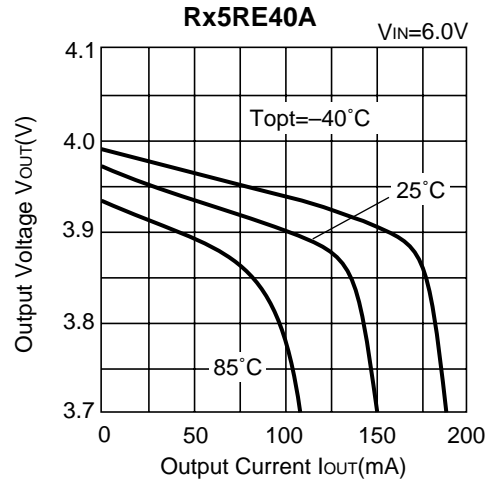
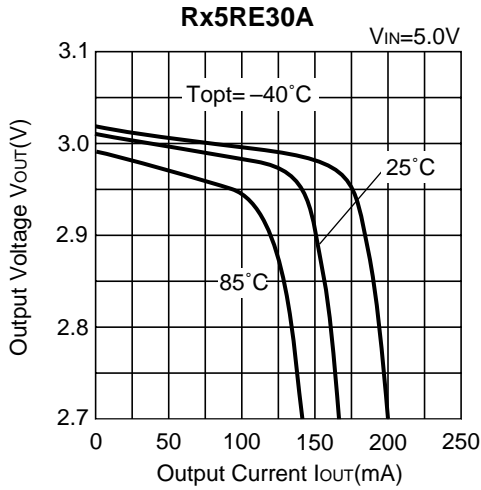

FIG. 4 Line Transient Response Test Circuit

# TYPICAL CHARACTERISTICS

## 1) Output Voltage vs. Output Current



## 2) Output Voltage vs. Input Voltage

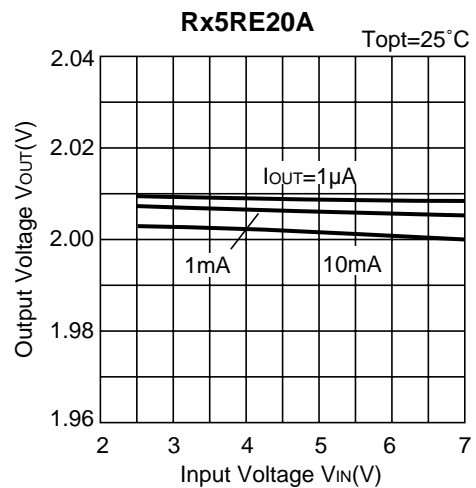
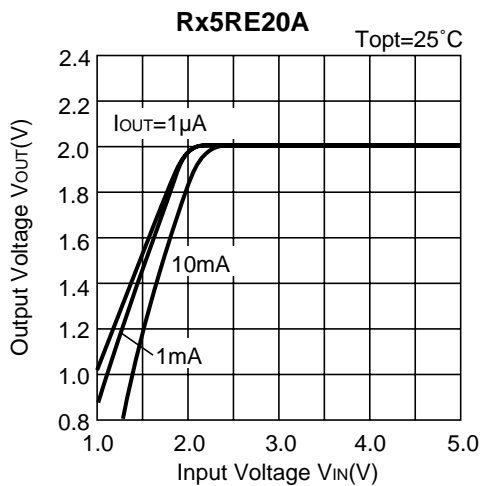

**Rx5RE**

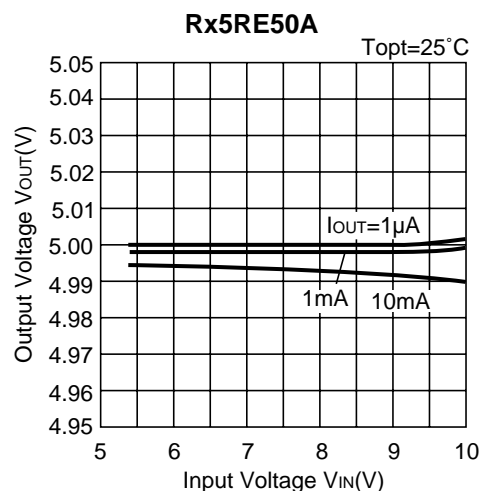
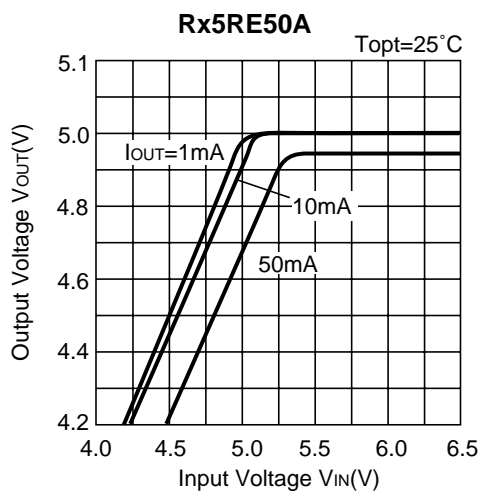
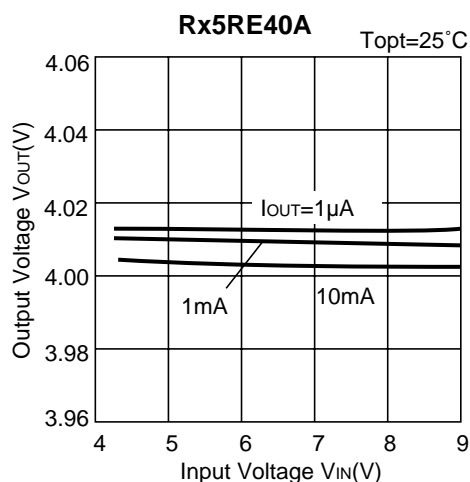
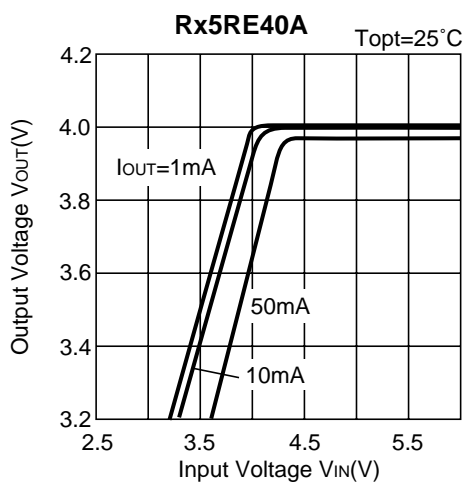
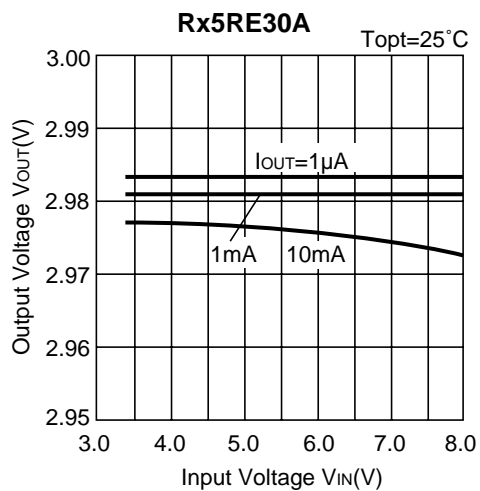
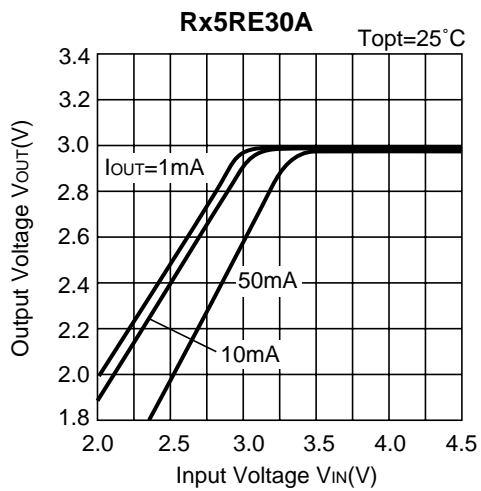

3) Dropout Voltage vs. Output Current

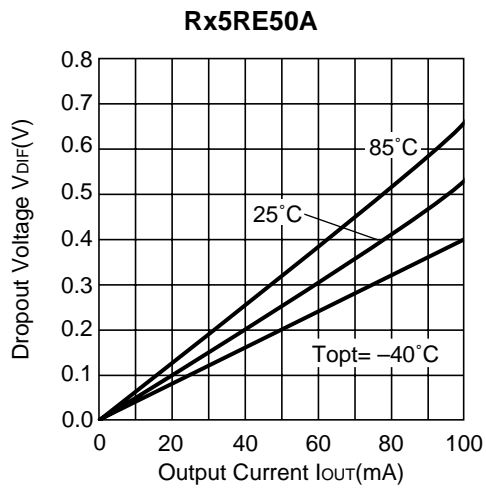
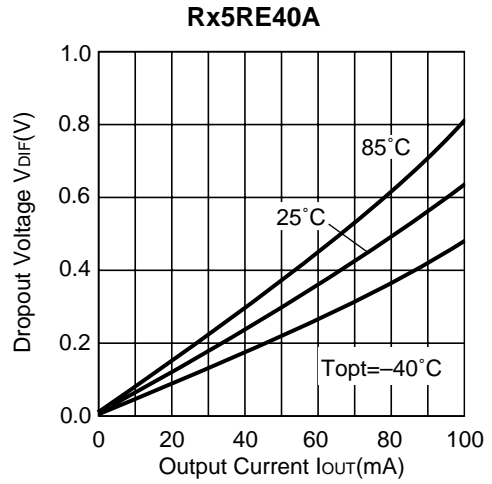
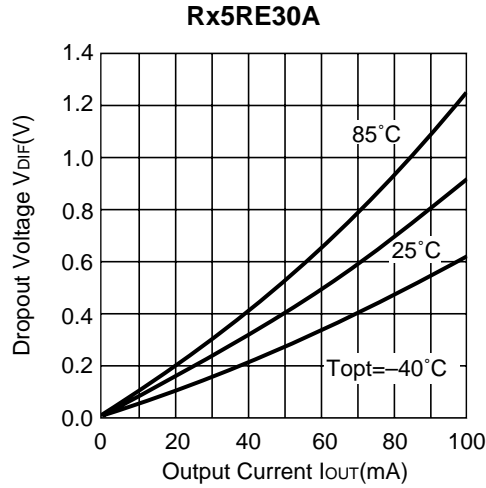

4) Output Voltage vs. Temperature

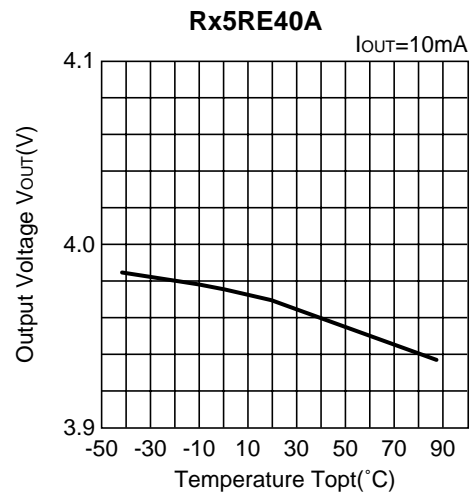
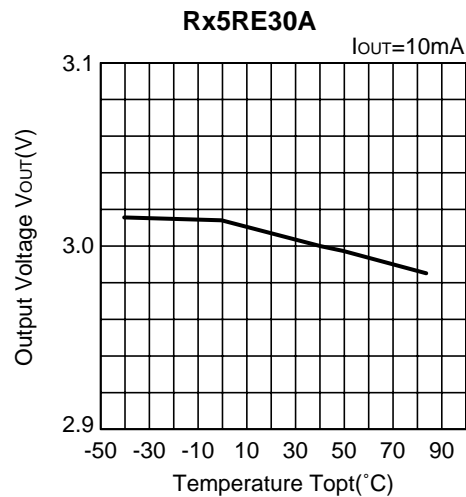

# Rx5RE

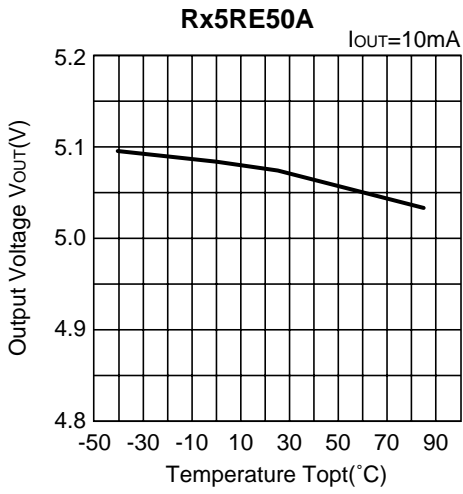

## 5) Quiescent Current vs. Input Voltage

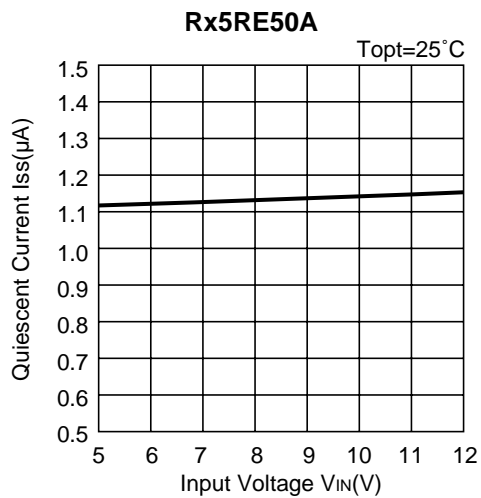
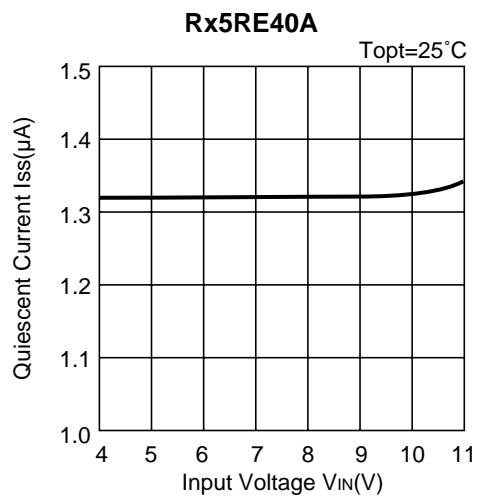
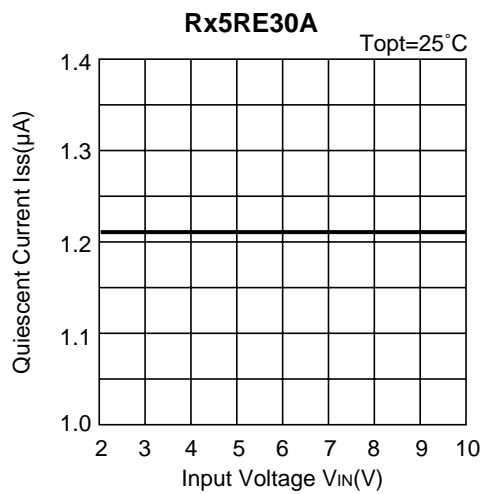
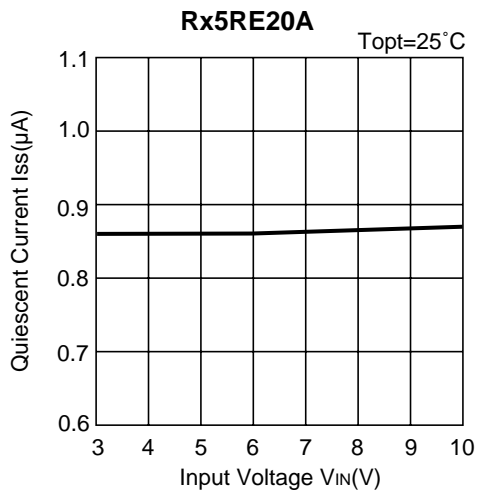

6) Quiescent Current vs. Temperature

Rx5RE20A

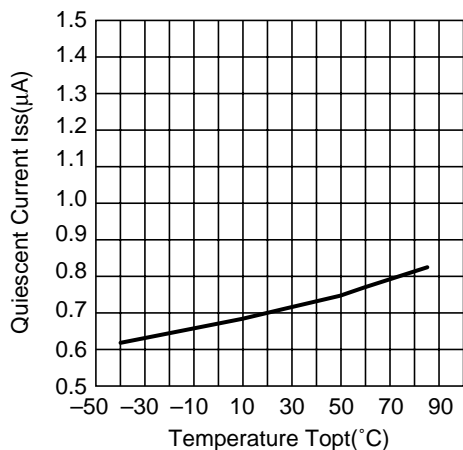

Rx5RE30A

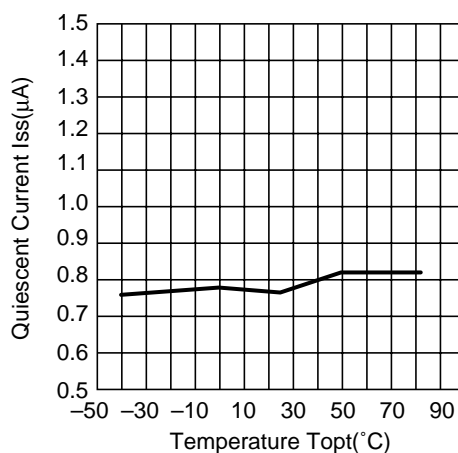

Rx5RE40A

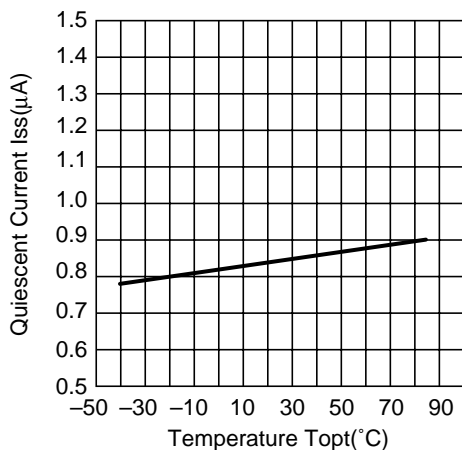

7) Dropout Voltage vs. Set Output Voltage

Rx5RE SERIES T<sub>opt</sub>=25°C

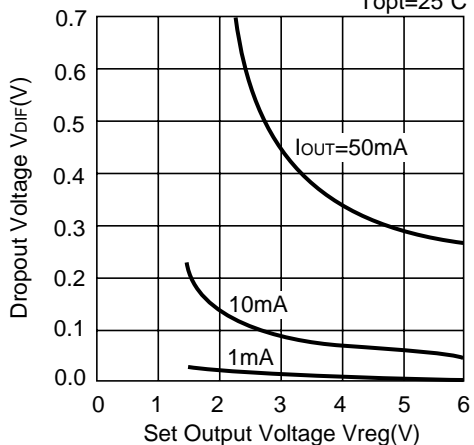

8) Line Transient Response (1)

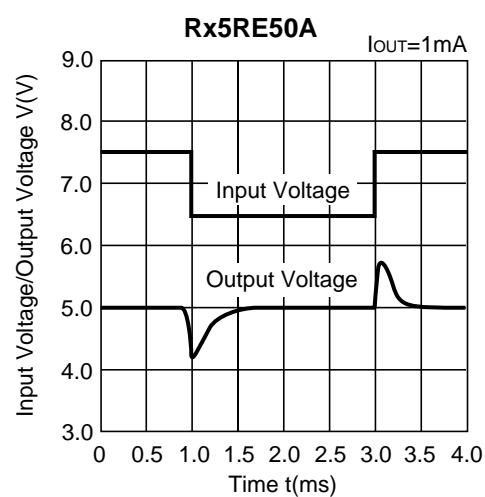
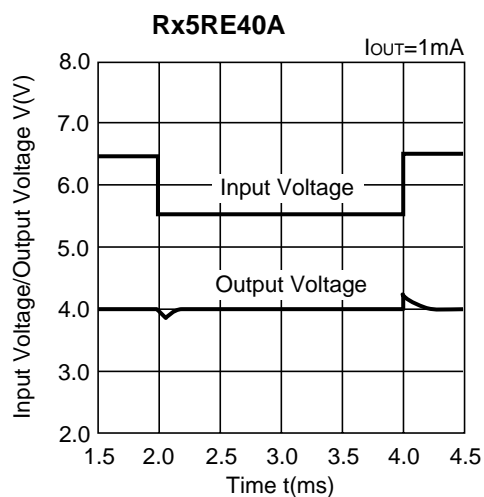
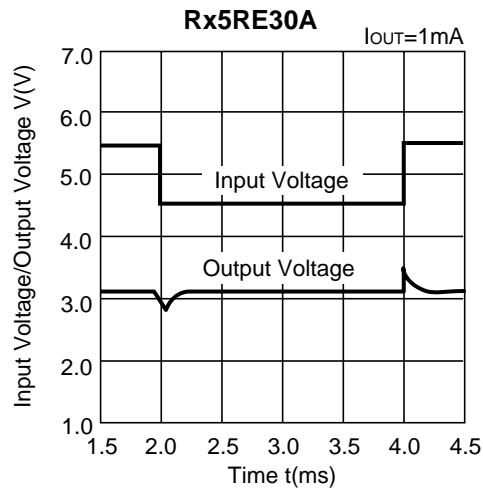
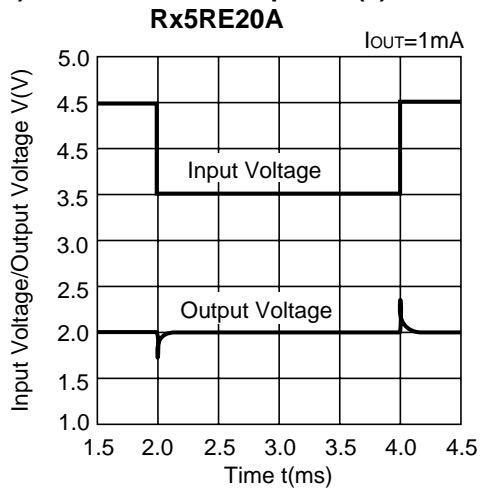

9) Line Transient Response (2)

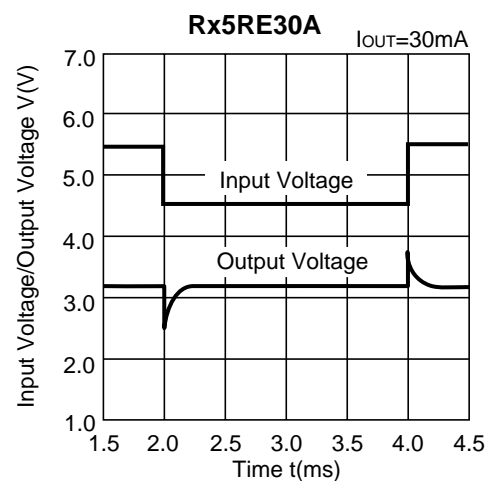
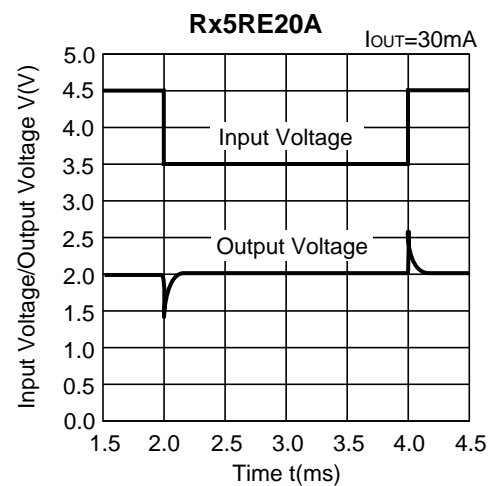



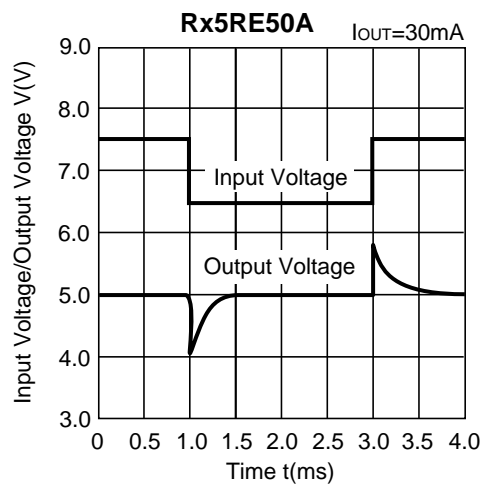
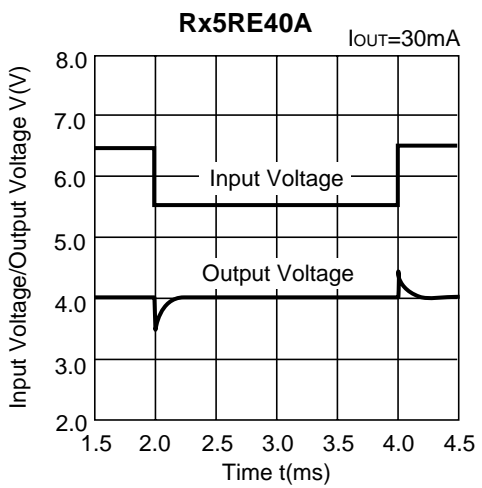

## TYPICAL APPLICATION

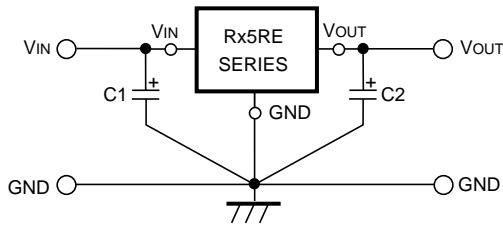

In Rx5RE Series, a constant voltage can be obtained without using capacitors C1 and C2. However, when the wire connected to VIN is long, use capacitor C1. Output noise can be reduced by using capacitor C2.

Insert capacitors C1 and C2 with the capacitance of 0.1μF to 2.0μF between input/output pins and GND pin with minimum wiring.

## APPLICATION CIRCUITS

### • VOLTAGE BOOST CIRCUIT

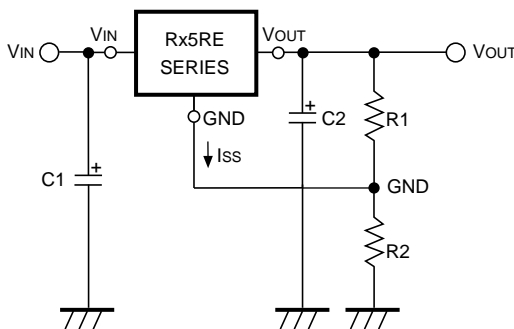

The output voltage can be obtained by the following formula :

$$V_{OUT} = V_{reg}^{*1} \cdot (1 + R2/R1) + I_{SS} \cdot R2$$

Since the quiescent current of Rx5RE Series is so small that the resistances of R1 and R2 can be set as large as several hundreds kΩ and therefore the supply current of “Voltage Boost Circuit” itself can be reduced.

Furthermore, since Rx5RE Series are operated by a constant voltage, the supply current of “Voltage Boost Circuit” is not substantially affected by the input voltage.

■ \*1) Vreg : Set Output Voltage of Rx5RE Series.

### • DUAL POWER SUPPLY CIRCUIT

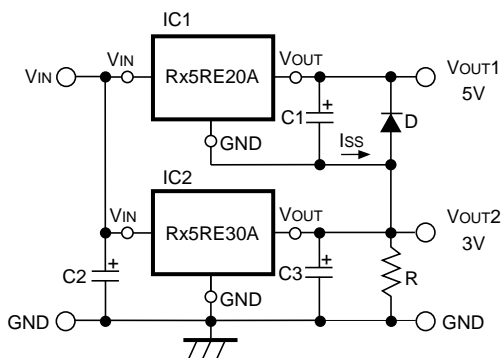

As shown in the circuit diagram, a dual power supply circuit can be constructed by using two Rx5RE Series.

This circuit diagram shows a dual power supply circuit with an output of 3V and an output of 5V. When the minimum output current of IC2 is larger than Iss of IC1, resistor R is unnecessary. Diode D is a protection diode for the case where VOUT2 becomes larger than VOUT1.

• CURRENT BOOST CIRCUIT

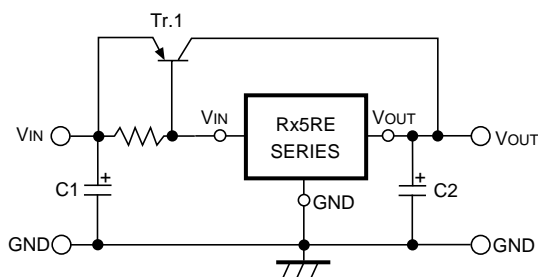

Output current of 120mA or more can be obtained by the current boost circuit constructed as shown in this circuit diagram.

• CURRENT BOOST CIRCUIT WITH OVERCURRENT LIMIT CIRCUIT

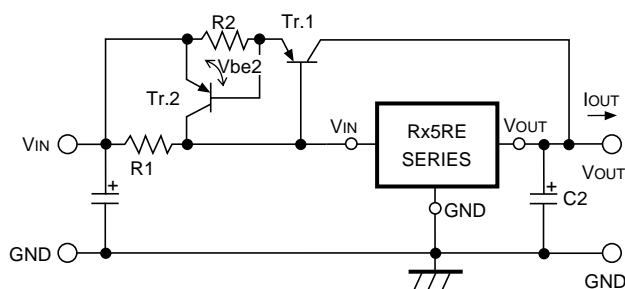

A circuit for protecting Tr.1 from the destruction caused by output short-circuit or overcurrent is shown in this circuit diagram.

When the voltage reduction caused by the current ( $I_{OUT}$ ) which flows through R2 reaches  $V_{be2}$  of Tr.2 by additionally providing the current boost circuit with Tr.2 and R2, Tr.2 is turned ON and the base current of Tr.1 is increased, so that the output current is limited.

Current limit of Overcurrent Limit Circuit is obtained as follows :

$$I_{OUT} \approx V_{be2}/R2$$

• CURRENT SOURCE

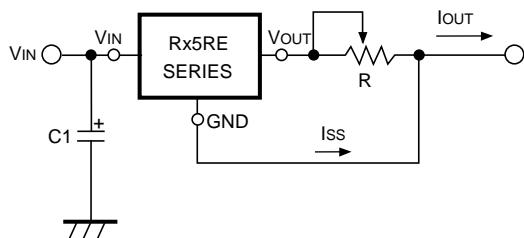

A current source with the structure as shown in this circuit diagram can be used. Output Current  $I_{OUT}$  is obtained as follows :

$$I_{OUT} = V_{reg}^{*1} / R + I_{SS}$$

Take care that Output Current  $I_{OUT}$  does not exceed its allowable current.

\*1)  $V_{reg}$  : Set Output Voltage of Rx5RE Series.



1. The products and the product specifications described in this document are subject to change or discontinuation of production without notice for reasons such as improvement. Therefore, before deciding to use the products, please refer to Ricoh sales representatives for the latest information thereon.
2. The materials in this document may not be copied or otherwise reproduced in whole or in part without prior written consent of Ricoh.
3. Please be sure to take any necessary formalities under relevant laws or regulations before exporting or otherwise taking out of your country the products or the technical information described herein.
4. The technical information described in this document shows typical characteristics of and example application circuits for the products. The release of such information is not to be construed as a warranty of or a grant of license under Ricoh's or any third party's intellectual property rights or any other rights.
5. The products listed in this document are intended and designed for use as general electronic components in standard applications (office equipment, telecommunication equipment, measuring instruments, consumer electronic products, amusement equipment etc.). Those customers intending to use a product in an application requiring extreme quality and reliability, for example, in a highly specific application where the failure or misoperation of the product could result in human injury or death (aircraft, spacevehicle, nuclear reactor control system, traffic control system, automotive and transportation equipment, combustion equipment, safety devices, life support system etc.) should first contact us.
6. We are making our continuous effort to improve the quality and reliability of our products, but semiconductor products are likely to fail with certain probability. In order to prevent any injury to persons or damages to property resulting from such failure, customers should be careful enough to incorporate safety measures in their design, such as redundancy feature, fire containment feature and fail-safe feature. We do not assume any liability or responsibility for any loss or damage arising from misuse or inappropriate use of the products.
7. Anti-radiation design is not implemented in the products described in this document.
8. The X-ray exposure can influence functions and characteristics of the products. Confirm the product functions and characteristics in the evaluation stage.
9. WLCSP products should be used in light shielded environments. The light exposure can influence functions and characteristics of the products under operation or storage.
10. There can be variation in the marking when different AOI (Automated Optical Inspection) equipment is used. In the case of recognizing the marking characteristic with AOI, please contact Ricoh sales or our distributor before attempting to use AOI.
11. Please contact Ricoh sales representatives should you have any questions or comments concerning the products or the technical information.



**Ricoh is committed to reducing the environmental loading materials in electrical devices with a view to contributing to the protection of human health and the environment.**

Ricoh has been providing RoHS compliant products since April 1, 2006 and Halogen-free products since April 1, 2012.

**RICOH** RICOH ELECTRONIC DEVICES CO., LTD.

<https://www.e-devices.ricoh.co.jp/en/>

#### Sales & Support Offices

##### **Ricoh Electronic Devices Co., Ltd.**

##### **Shin-Yokohama Office (International Sales)**

2-3, Shin-Yokohama 3-chome, Kohoku-ku, Yokohama-shi, Kanagawa, 222-8530, Japan  
Phone: +81-50-3814-7687 Fax: +81-45-474-0074

##### **Ricoh Americas Holdings, Inc.**

675 Campbell Technology Parkway, Suite 200 Campbell, CA 95008, U.S.A.  
Phone: +1-408-610-3105

##### **Ricoh Europe (Netherlands) B.V.**

##### **Semiconductor Support Centre**

Prof. W.H. Keesomlaan 1, 1183 DJ Amstelveen, The Netherlands  
Phone: +31-20-5474-309

##### **Ricoh International B.V. - German Branch**

##### **Semiconductor Sales and Support Centre**

Oberrather Strasse 6, 40472 Düsseldorf, Germany  
Phone: +49-211-6546-0

##### **Ricoh Electronic Devices Korea Co., Ltd.**

3F, Haesung Bldg, 504, Teheran-ro, Gangnam-gu, Seoul, 135-725, Korea  
Phone: +82-2-2135-5700 Fax: +82-2-2051-5713

##### **Ricoh Electronic Devices Shanghai Co., Ltd.**

Room 403, No.2 Building, No.690 Bibo Road, Pu Dong New District, Shanghai 201203,  
People's Republic of China  
Phone: +86-21-5027-3200 Fax: +86-21-5027-3299

##### **Ricoh Electronic Devices Shanghai Co., Ltd.**

##### **Shenzhen Branch**

1205, Block D (Jinlong Building), Kingkey 100, Hongbao Road, Luohu District,  
Shenzhen, China  
Phone: +86-755-8348-7600 Ext 225

##### **Ricoh Electronic Devices Co., Ltd.**

##### **Taipei office**

Room 109, 10F-1, No.51, Hengyang Rd., Taipei City, Taiwan (R.O.C.)  
Phone: +886-2-2313-1621/1622 Fax: +886-2-2313-1623

## X-ON Electronics

Largest Supplier of Electrical and Electronic Components

*Click to view similar products for [LDO Voltage Regulators](#) category:*

*Click to view products by [Nisshinbo](#) manufacturer:*

Other Similar products are found below :

[AP7363-SP-13](#) [L79M05TL-E](#) [TCR3DF185,LM\(CT](#) [TCR3DF24,LM\(CT](#) [TCR3DF285,LM\(CT](#) [TCR3DF31,LM\(CT](#) [TCR3DF45,LM\(CT](#)  
[MP2013GQ-33-Z](#) [059985X](#) [NCP4687DH15T1G](#) [701326R](#) [TCR2EN28,LF\(S](#) [NCV8170AXV250T2G](#) [TCR3DF27,LM\(CT](#)  
[TCR3DF19,LM\(CT](#) [TCR3DF125,LM\(CT](#) [TCR2EN18,LF\(S](#) [AP2112R5A-3.3TRG1](#) [AP7315-25W5-7](#) [IFX30081LDVGRNXUMA1](#)  
[NCV47411PAAJR2G](#) [AP2113KTR-G1](#) [AP2111H-1.2TRG1](#) [ZLDO1117QK50TC](#) [AZ1117IH-1.8TRG1](#) [AZ1117ID-ADJTRG1](#)  
[TCR3DG12,LF](#) [MIC5514-3.3YMT-T5](#) [MIC5512-1.2YMT-T5](#) [MIC5317-2.8YM5-T5](#) [SCD7912BTG](#) [NCP154MX180270TAG](#) [SCD33269T-](#)  
[5.0G](#) [NCV8170BMX330TCG](#) [NCV8170AMX120TCG](#) [NCP706ABMX300TAG](#) [NCP153MX330180TCG](#) [NCP114BMX075TCG](#)  
[MC33269T-3.5G](#) [CAT6243-ADJCMT5T](#) [TCR3DG33,LF](#) [AP2127N-1.0TRG1](#) [TCR4DG35,LF](#) [LT1117CST-3.3](#) [TAR5S15U\(TE85L,F\)](#)  
[TAR5S18U\(TE85L,F\)](#) [TCR3UG19A,LF](#) [TCR4DG105,LF](#) [NCV8170AMX360TCG](#) [MIC94310-NYMT-T5](#)