

Good Transient Response Low Voltage 500 mA LDO for High Temperature Applications*

NO.EA-375-200904

OUTLINE

The RP111x is a CMOS-based LDO regulator featuring 500 mA output current. The input voltage is as low as 1.4 V and the output voltage can be set from 0.7 V. Due to a built-in 0.46Ω (at $V_{OUT} = 2.8 \text{ V}$) on-resistor, RP111x can provide a low dropout voltage. RP111x also features an excellent line transient response, ripple rejection at 75 dB, and low noise. The output voltage accuracy is as high as $\pm 0.8\%$ and the temperature drift coefficient of output voltage is low at $\pm 30 \text{ ppm}/^\circ\text{C}$. The accuracy of the output voltage of RP111x includes the temperature characteristics and the load transient response has been improved. The typ. and max value of under/overshoot for various output current are shown in the typical characteristics, therefore the accuracy of the output voltage estimation will be easy on the actual operating cases. In addition to a fold-back protection circuit built into conventional regulators, RP111x contains a thermal shutdown circuit and an inrush current limit circuit.

SOT-23-5, SOT-89-5, and DFN1212-6 packages are available.

* This product is a high-reliability semiconductor device that is designed for the use in high-temperature environment. This product has successfully passed our rigorous reliability test in addition to the high-temperature test. To distinguish this product from our consumer products, "-Yx" is added to the end of the name of the product.

FEATURES

- Input Voltage Range (Maximum Rating)..... 1.4 V to 5.25 V (6.0 V)
- Operating Temperature -40°C to 105°C
- Supply Current..... Typ. $80 \mu\text{A}$
- Standby Current Typ. $0.1 \mu\text{A}$
- Dropout Voltage Typ. 0.23 V ($I_{OUT} = 500 \text{ mA}$, $V_{SET} = 2.5 \text{ V}$)
- Ripple Rejection Typ. 75 dB ($f = 1 \text{ kHz}$)
Typ. 70 dB ($f = 10 \text{ kHz}$)
- Output Voltage Accuracy $\pm 0.8\%$ ($V_{SET} \geq 1.8 \text{ V}$)
- Output Voltage Temperature Coefficient..... Typ. $\pm 30 \text{ ppm}/^\circ\text{C}$ ($V_{SET} \geq 1.8 \text{ V}$)
- Line Regulation Typ. $0.02\%/V$
- Input Transient Response..... Typ. $\pm 1.5 \text{ mV}$ ($V_{IN}: V_{SET} + 0.5 \text{ V} \leftrightarrow V_{SET} + 1.5 \text{ V}$ ($t_r = t_f = 5.0 \mu\text{s}$),
 $V_{IN} \geq 1.4 \text{ V}$, $I_{OUT} = 30 \text{ mA}$)
- Packages..... DFN1212-6, SOT-23-5, SOT-89-5
- Output Voltage Range 0.7 V , 1.2 V , 1.5 V , 1.8 V , 2.5 V , 2.7 V , 2.8 V , 3.0 V , 3.3 V , 3.4 V
Contact Ricoh sales representatives for other voltages.
- Built-in Fold-back Protection Circuit Typ. 50 mA
- Thermal Shutdown Temperature 165°C
- Inrush Current Limit..... Typ. 400 mA (for $180 \mu\text{s}$ after start-up)
- Ceramic capacitors are recommended to be used with this IC
..... $1.0 \mu\text{F}$ or more
- Output Noise $20 \times V_{SET} \mu\text{Vrms}$ ($\text{BW} = 10 \text{ Hz to } 100 \text{ kHz}$, $V_{SET} \geq 1.8 \text{ V}$)

APPLICATIONS

- Industrial equipments such as FAs and smart meters
- Equipments used under high-temperature conditions
- Equipments accompanied by self-heating

BLOCK DIAGRAMS

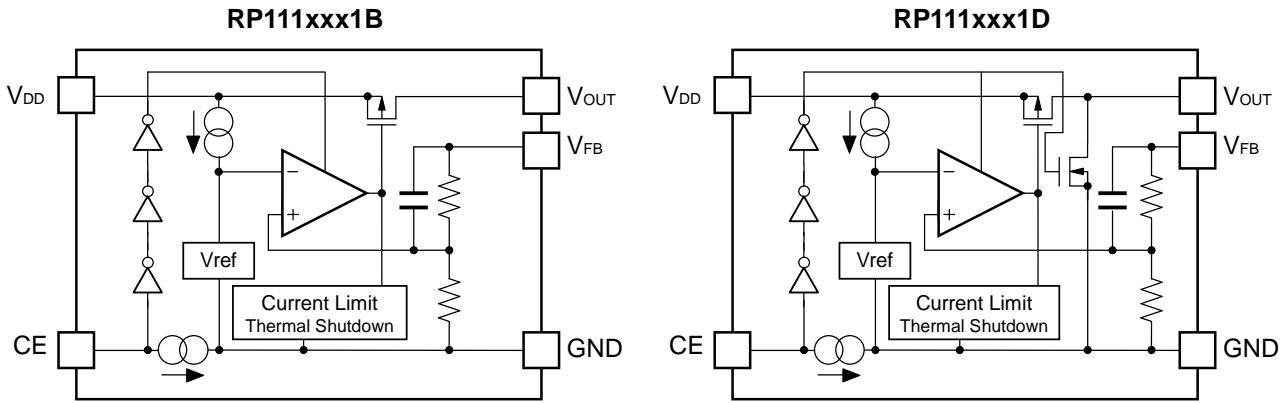

SELECTION GUIDE

The set output voltage, auto-discharge function,^{*1} and package type for the IC are user-selectable.

Product Name	Package	Quantity per Reel	Pb Free	Halogen Free
RP111Lxx1*-TR-Y	DFN1212-6	5,000 pcs	Yes	Yes
RP111Nxx1*-TR-YE	SOT-23-5	3,000 pcs	Yes	Yes
RP111Hxx1*-T1-YE	SOT-89-5	1,000 pcs	Yes	Yes

xx: Specify the set output voltage (V_{SET})
 0.7 V (07), 1.2 V (12), 1.5 V (15), 1.8 V (18), 2.5 V (25), 2.7 V (27), 2.8 V (28),
 3.0 V (30), 3.3 V (33), 3.4 V (34)

Contact Ricoh sales representatives for other voltages.

*: Specify the auto-discharge function at off state
 (B) Active-high, without auto discharge function at off state
 (D) Active-high, with auto discharge function at off state

^{*1} Auto-discharge function quickly lowers the output voltage to 0 V by releasing the electrical charge in the external capacitor when the chip enable signal is switched from the active mode to the standby mode.

PIN DESCRIPTIONS

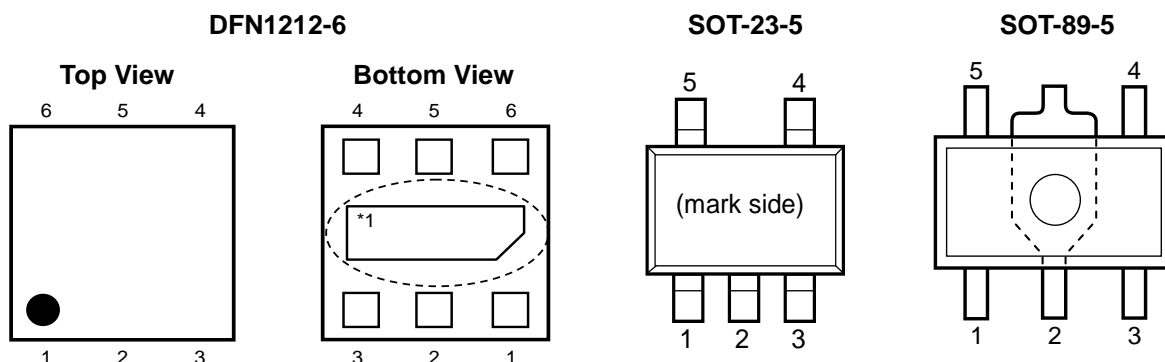

DFN1212-6

Pin No.	Symbol	Description
1	V_{OUT}	Output Pin
2	V_{FB}	Feed Back Pin
3	GND	Ground Pin
4	CE	Chip Enable Pin (Active-high)
5	NC	No connection
6	V_{DD}	Input Pin

*1 The tab on the bottom of the package enhances thermal performance and is electrically connected to GND (substrate level). It is recommended that the tab be connected to the ground plane on the board, or otherwise be left floating.

SOT-23-5

Pin No	Symbol	Description
1	V_{DD}	Input Pin
2	GND	Ground Pin
3	CE	Chip Enable Pin (Active-high)
4	V_{FB}	Feed Back Pin
5	V_{OUT}	Output Pin

SOT-89-5

Pin No	Symbol	Description
1	V_{FB}	Feed Back Pin
2	GND	Ground Pin
3	CE	Chip Enable Pin (Active-high)
4	V_{DD}	Input Pin
5	V_{OUT}	Output Pin

The V_{OUT} pin should be connected to the V_{FB} pin when using RP111x as an internal fixed output voltage type. In case of using this device as an external adjustable type, refer to *ADJUSTABLE OUTPUT VOLTAGE SETTING* for detailed information.

RP111x-Y

NO.EA-375-200904

ABSOLUTE MAXIMUM RATINGS

Symbol	Item	Rating	Unit
V _{IN}	Input Voltage	-0.3 to 6.0	V
V _{CE}	Input Voltage (CE Pin)	-0.3 to 6.0	V
V _{OUT}	Output Voltage	-0.3 to V _{IN} + 0.3	V
I _{OUT}	Output Current	510	mA
P _D	Power Dissipation (DFN1212-6) ^{*1}	Standard Land Pattern	600
	Power Dissipation (SOT-23-5) ^{*1}	Standard Land Pattern	420
	Power Dissipation (SOT-89-5) ^{*1}	Standard Land Pattern	900
		High Wattage Land Pattern	1300
T _j	Junction Temperature	-40 to 125	°C
T _{stg}	Storage Temperature	-55 to 125	°C

^{*1} Refer to *PACKAGE INFORMATION* for detailed information.

ABSOLUTE MAXIMUM RATINGS

Electronic and mechanical stress momentarily exceeded absolute maximum ratings may cause permanent damage and may degrade the lifetime and safety for both device and system using the device in the field. The functional operation at or over these absolute maximum ratings are not assured.

RECOMMENDED OPERATING CONDITIONS

Symbol	Item	Rating	Unit
V _{IN}	Input Voltage ^{*2}	1.4 to 5.25	V
T _a	Operating Temperature	-40 to 105	°C

^{*2} In case of exceeding the maximum Input Voltage of 5.25 V, the device must be operated on condition that the Input Voltage is up to 5.5 V and the total operating time is within 500 hrs.

RECOMMENDED OPERATING CONDITIONS

All of electronic equipment should be designed that the mounted semiconductor devices operate within the recommended operating conditions. The semiconductor devices cannot operate normally over the recommended operating conditions, even if they are used over such conditions by momentary electronic noise or surge. And the semiconductor devices may receive serious damage when they continue to operate over the recommended operating conditions.

ELECTRICAL CHARACTERISTICS

$V_{IN} = V_{SET} + 1.0 \text{ V}$ ($V_{SET} > 1.5 \text{ V}$), $V_{IN} = 2.5 \text{ V}$ ($V_{SET} \leq 1.5 \text{ V}$), $I_{OUT} = 1 \text{ mA}$,

$C_{IN} = C_{OUT} = 1.0 \mu\text{F}$, unless otherwise noted.

The specifications surrounded by are guaranteed by design engineering at $-40^\circ\text{C} \leq T_a \leq 105^\circ\text{C}$.

RP111xxx1D/B

($T_a = 25^\circ\text{C}$)

Symbol	Item	Conditions	Min.	Typ.	Max.	Unit	
V_{OUT}	Output voltage	$T_a = 25^\circ\text{C}$	$V_{SET} \geq 1.8 \text{ V}$	x 0.992		x 1.008	V
			$V_{SET} < 1.8 \text{ V}$	-18		18	mV
		$-40^\circ\text{C} \leq T_a \leq 105^\circ\text{C}$	$V_{SET} \geq 1.8 \text{ V}$	x 0.985		x 1.015	V
			$V_{SET} < 1.8 \text{ V}$	-55		50	mV
I_{OUT}	Output Current		500			mA	
$\Delta V_{OUT}/\Delta I_{OUT}$	Load regulation	$1 \text{ mA} \leq I_{OUT} \leq 500 \text{ mA}$		1	20	mV	
V_{TRLD}	Load Transient Response	$I_{OUT}: 1 \text{ mA} \Leftrightarrow 250 \text{ mA}$ ($t_r = t_f = 0.5 \mu\text{s}$)	$C_{OUT} = 1 \mu\text{F}$		-75 +45	mV	
			$C_{OUT} = 2.2 \mu\text{F}$		-55 +35		
		$I_{OUT}: 1 \text{ mA} \Leftrightarrow 250 \text{ mA}$ ($t_r = t_f = 5 \mu\text{s}$)	$C_{OUT} = 1 \mu\text{F}$		-20 +15		
V_{DIF}	Dropout Voltage	Refer to the <i>Dropout Voltage</i>					
I_{SS}	Supply Current	$I_{OUT} = 0 \text{ mA}$		80	125	μA	
$I_{standby}$	Standby Current	$V_{CE} = 0 \text{ V}$		0.1	7.0	μA	
$\Delta V_{OUT}/\Delta V_{IN}$	Line regulation	$V_{SET} + 0.5 \text{ V} \leq V_{IN} \leq 5.25 \text{ V}$, $V_{IN} \geq 1.4 \text{ V}$		0.02	0.10	%/V	
I_{SC}	Short Current Limit	$V_{OUT} = 0 \text{ V}$		50		mA	
I_{PD}	CE Pull-down Current			0.3	0.6	μA	
V_{CEH}	CE Input Voltage "H"		1.0			V	
V_{CEL}	CE Input Voltage "L"				0.4	V	
T_{TSD}	Thermal Shutdown Temperature	Junction Temperature		165		$^\circ\text{C}$	
T_{TSR}	Thermal Shutdown Released Temperature	Junction Temperature		100		$^\circ\text{C}$	
R_{LOW}	LOW output Nch Tr. ON Resistance (RP111xxx1D only)	$V_{IN} = 4.0 \text{ V}$, $V_{CE} = 0 \text{ V}$		60		Ω	

All test items listed under Electrical Characteristics are done under the pulse load condition ($T_j \approx T_a = 25^\circ\text{C}$) except for Load Transient Response.

RP111x-YNO.EA-375-200904

The specifications surrounded by are guaranteed by design engineering at $-40^{\circ}\text{C} \leq T_a \leq 105^{\circ}\text{C}$.**Dropout Voltage**

(Ta = 25°C)

Output Voltage V_{OUT} (V)	Dropout Voltage V_{DIF} (V)		
	Condition	Typ.	Max.
$0.7 \leq V_{\text{SET}} < 0.8$	$I_{\text{OUT}} = 500 \text{ mA}$	0.58	0.88
$0.8 \leq V_{\text{SET}} < 0.9$		0.52	0.80
$0.9 \leq V_{\text{SET}} < 1.0$		0.45	0.70
$1.0 \leq V_{\text{SET}} < 1.2$		0.42	0.64
$1.2 \leq V_{\text{SET}} < 1.4$		0.35	0.53
$1.4 \leq V_{\text{SET}} < 1.8$		0.31	0.48
$1.8 \leq V_{\text{SET}} < 2.1$		0.27	0.44
$2.1 \leq V_{\text{SET}} < 2.5$		0.25	0.38
$2.5 \leq V_{\text{SET}} < 3.0$		0.23	0.34
$3.0 \leq V_{\text{SET}} \leq 3.6$		0.22	0.32

TYPICAL APPLICATION

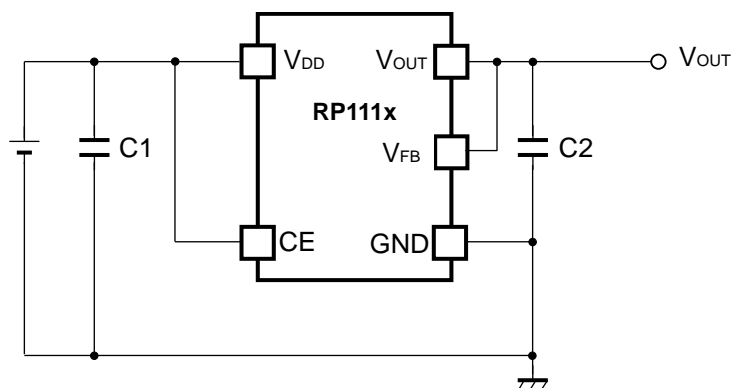

External Components

C1, C2: Ceramic Capacitor 1.0 μ F Murata GRM155B31A105KE15

TECHNICAL NOTES

Phase Compensation

In this device, phase compensation is made for securing stable operation even if the load current is varied. For this purpose, use a 1.0 μ F or more capacitor C2.

In case of using a tantalum capacitor, and its ESR is large, the output may be unstable. Therefore, select C2 carefully considering its frequency characteristics.

When using the Adjustable Output Voltage Type, set 4.7 μ F or more of the output capacitor C2 as close as possible to the device, and make wiring as short as possible.

PCB Layout

Make V_{DD} and GND lines sufficient. If their impedance is high, noise pickup or unstable operation may result.

Connect a capacitor C1 with a capacitance value as much as 1.0 μ F or more between V_{DD} and GND pin, and as close as possible to the pins.

Set external components, especially the output capacitor C2, as close as possible to the device, and make wiring as short as possible (Refer to *TYPICAL APPLICATION*).

Transient Response

When using the Adjustable Output Voltage Type, the transient response could be affected by the external resistors. Evaluate the circuit taking the actual conditions of use into account.

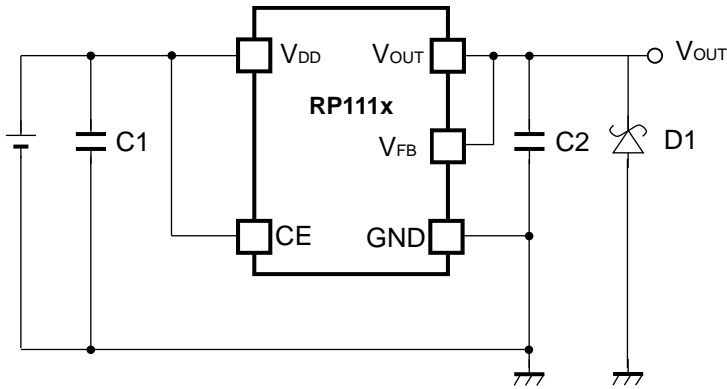
TYPICAL APPLICATION FOR IC CHIP BREAKDOWN PREVENTION

When a sudden surge of electrical current travels along the V_{OUT} pin and GND due to a short-circuit, electrical resonance of a circuit involving an output capacitor (C2) and a short circuit inductor generates a negative voltage and may damage the device or the load devices. Connecting a schottky diode (D1) between the V_{OUT} pin and GND has the effect of preventing damage to them.

ADJUSTABLE OUTPUT VOLTAGE SETTING

Output Voltage Setting

RP111x is capable of adjusting the output voltage by using the external divider resistors.

If the V_{FB} voltage fixed in the device is described as $setV_{FB}$, the output voltage can be set by using the following formulas.

$$I_1 = I_{IC} + I_2 \dots\dots\dots (1)$$

$$I_2 = setV_{FB} / R_2 \dots\dots\dots (2)$$

Thus,

$$I_1 = I_{IC} + setV_{FB} / R_2 \dots\dots\dots (3)$$

Therefore,

$$V_{OUT} = setV_{FB} + R_1 \times I_1 \dots\dots\dots (4)$$

Put formula (3) into formula (4), then

$$\begin{aligned} V_{OUT} &= setV_{FB} + R_1 \times (I_{IC} + setV_{FB} / R_2) \\ &= setV_{FB} \times (1 + R_1/R_2) + R_1 \times I_{IC} \dots\dots\dots (5) \end{aligned}$$

In formula (5), $R_1 \times I_{IC}$ is the error-causing factor in V_{OUT} .

As for I_{IC} ,

$$I_{IC} = setV_{FB} / R_{IC} \dots\dots\dots (6)$$

Therefore, the error-causing factor $R_1 \times I_{IC}$ can be described as follows.

$$\begin{aligned} R_1 \times I_{IC} &= R_1 \times setV_{FB} / R_{IC} \\ &= setV_{FB} \times R_1 / R_{IC} \dots\dots\dots (7) \end{aligned}$$

For better accuracy, choosing $R_1 \ll R_{IC}$ reduces this error.

Without the error-causing factor $R_1 \times I_{IC}$, the output voltage can be calculated by the following formula.

$$V_{OUT} = setV_{FB} \times ((R_1 + R_2) / R_2) \dots\dots\dots (8)$$

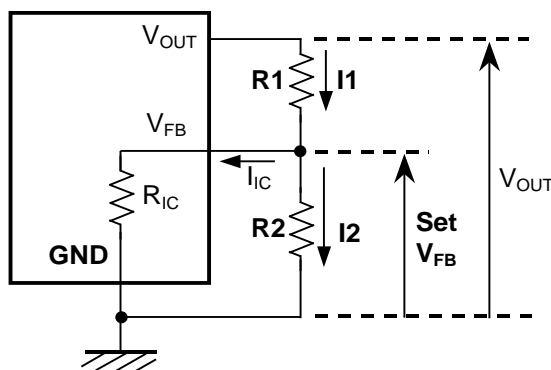

The output voltage of the externally adjustable output voltage type should be set to 3.6 V or less.

The resistance of R_2 should be 16 k Ω or less.

TRANSIENT RESPONSE

The RP111x has been improved in overall output voltage characteristics including temperature and transient response. The load transient response indicated under the Electrical Characteristics is guaranteed by design based on the condition when I_{OUT} changes from 1 mA to 250 mA or 250 mA to 1 mA. The output voltage variations under the other load conditions, the characteristic examples are shown below.

RP111x151x

$V_{IN} = 2.5\text{ V}$, $-40^{\circ}\text{C} \leq T_a \leq 85^{\circ}\text{C}$

$C_{IN} = 1.0\ \mu\text{F}$, $C_{OUT} = 1.0\ \mu\text{F}$, $I_{OUT} = 1\ \text{mA} \Leftrightarrow$ Peak Output Current

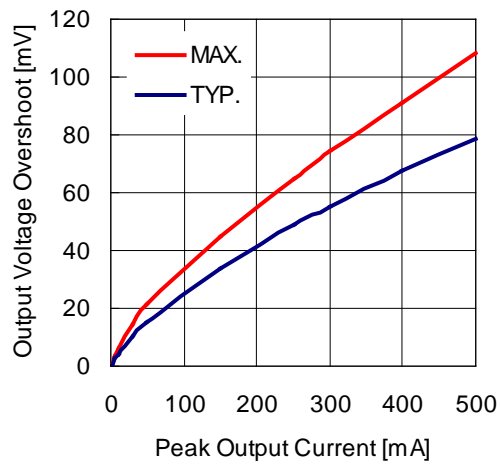
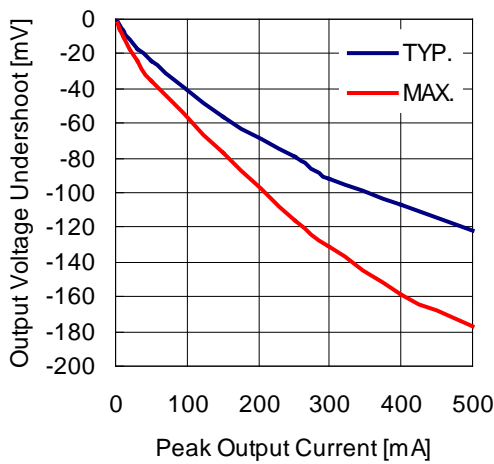

$C_{IN} = 1.0\ \mu\text{F}$, $C_{OUT} = 2.2\ \mu\text{F}$, $I_{OUT} = 1\ \text{mA} \Leftrightarrow$ Peak Output Current

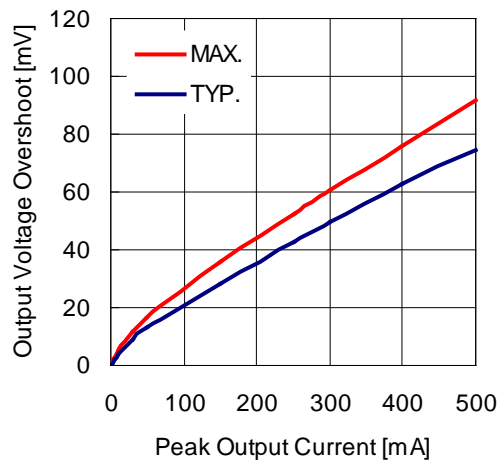
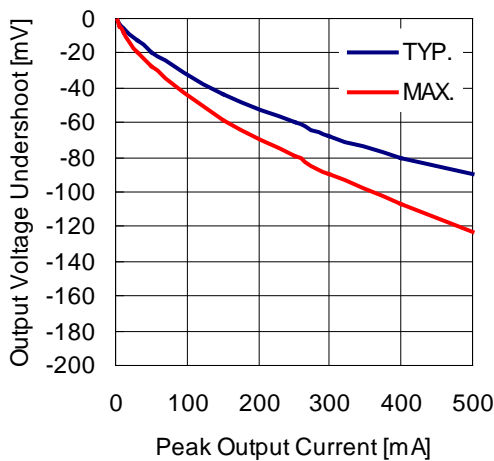

$C_{IN} = 1.0 \mu F, C_{OUT} = 1.0 \mu F, I_{OUT} = 1 \text{ mA} \leftrightarrow$ Peak Output Current

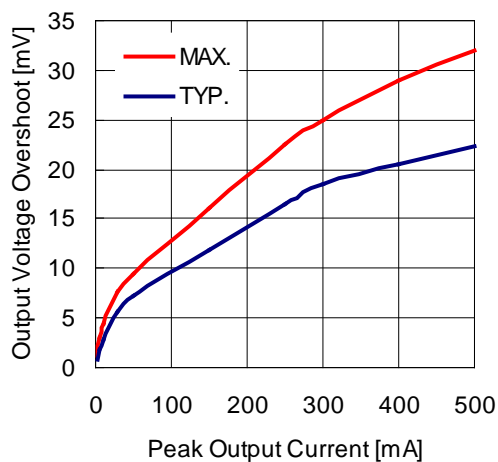
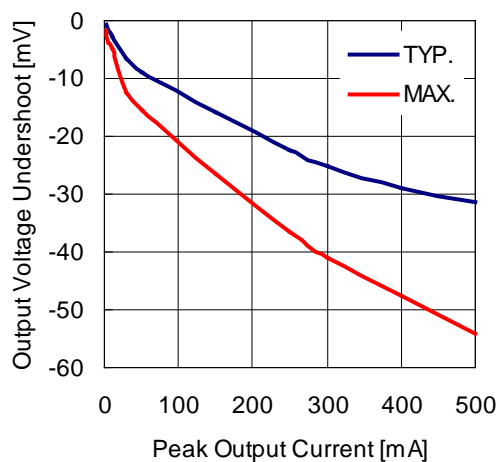

RP111x281x

$V_{IN} = 3.8 \text{ V}, -40^{\circ}\text{C} \leq T_a \leq 85^{\circ}\text{C}$

$C_{IN} = 1.0 \mu F, C_{OUT} = 1.0 \mu F, I_{OUT} = 1 \text{ mA} \leftrightarrow$ Peak Output Current

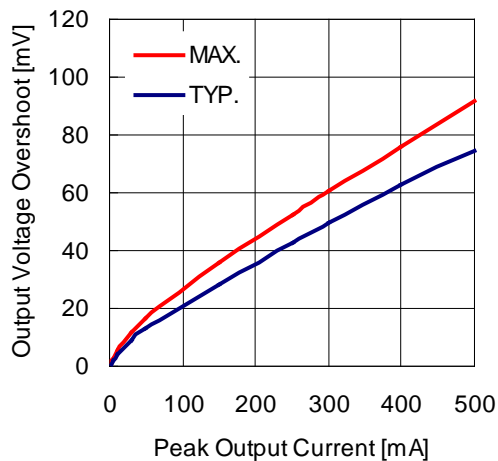
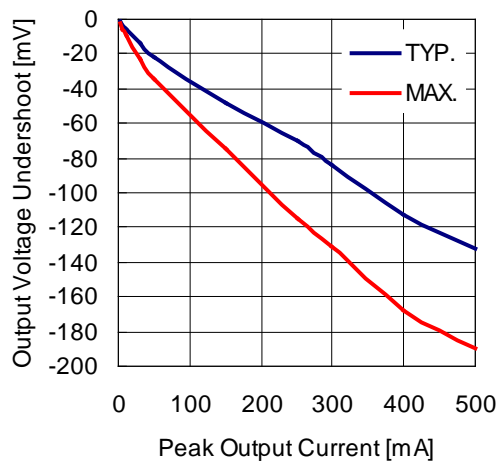

$C_{IN} = 1.0 \mu F, C_{OUT} = 2.2 \mu F, I_{OUT} = 1 \text{ mA} \leftrightarrow$ Peak Output Current

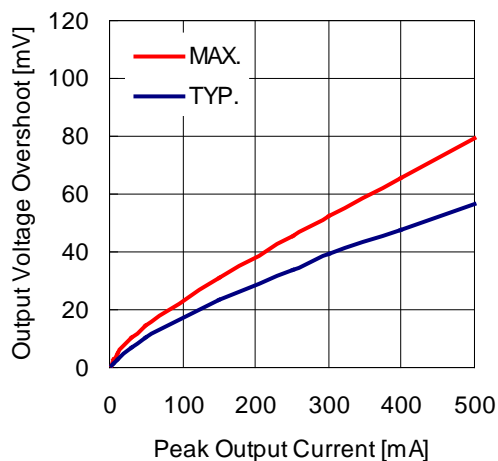
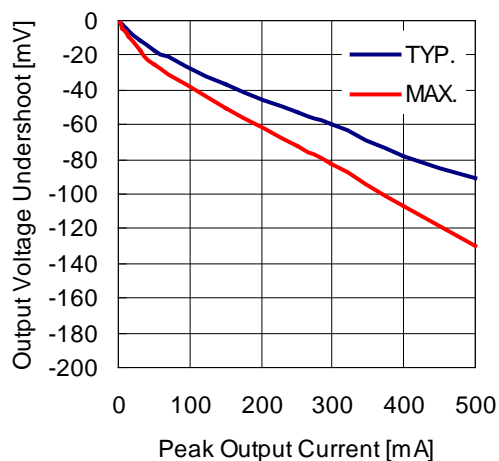

$C_{IN} = 1.0 \mu F, C_{OUT} = 1.0 \mu F, I_{OUT} = 1 \text{ mA} \Leftrightarrow$ Peak Output Current

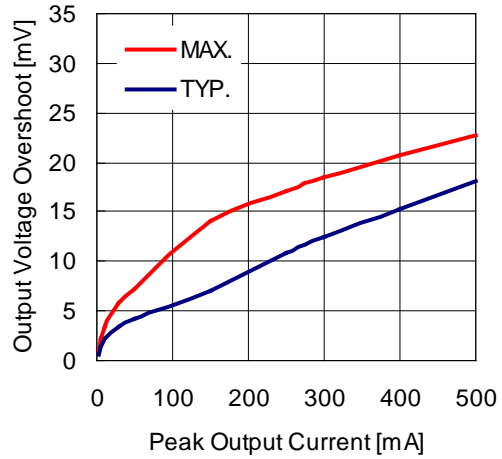
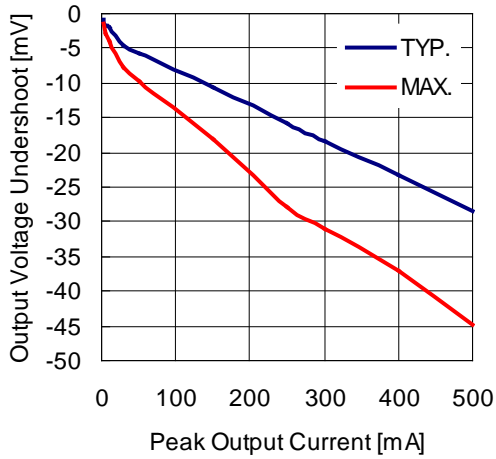

Input Transient Response has the output voltage dependency. Please refer to the characteristic examples below.

$V_{IN}: V_{SET} + 0.5 \text{ V} \Leftrightarrow V_{SET} + 1.5 \text{ V} (tr = tf = 5.0 \mu s), V_{IN} \geq 1.4 \text{ V},$
 $C_{OUT} = 1.0 \mu F, I_{OUT} = 30 \text{ mA}$

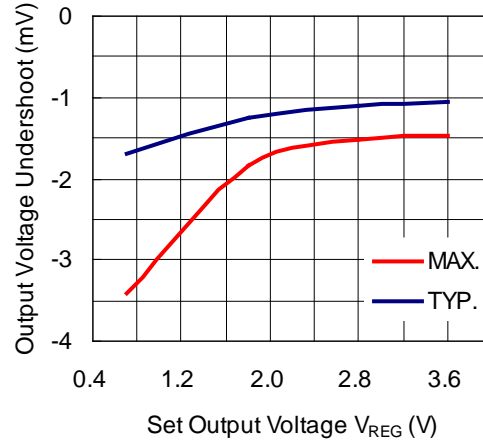
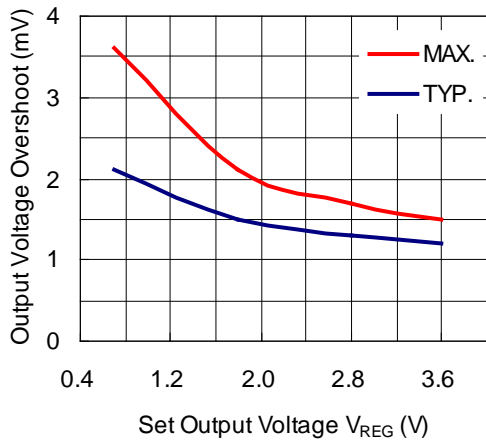

The graphs shown above are reference data.

For the better transient response, a capacitor with higher capacitance is recommended and the wire impedance of GND and V_{OUT} should be minimized as possible.

The transient response characteristics depend on the external parts and PCB layout. Therefore, the operating conditions for the transient response in the application should be considered and evaluation is necessary.

PACKAGE INFORMATION

POWER DISSIPATION (DFN1212-6)

Power Dissipation (P_D) depends on conditions of mounting on board. This specification is based on the measurement at the condition below:

Measurement Conditions

	Standard Test Land Pattern
Environment	Mounting on Board (Wind velocity = 0 m/s)
Board Material	Glass cloth epoxy plastic (Double sided)
Board Dimensions	40 mm*40 mm*1.6 mm
Copper Ratio	Top side: Approx. 50%, Back side: Approx. 50%
Through-holes	ϕ 0.5 mm * 28 pcs

Measurement Result ($T_a = 25^\circ\text{C}$, $T_{jmax} = 125^\circ\text{C}$)

	Standard Test Land Pattern
Power Dissipation	600 mW
Thermal Resistance	$\theta_{ja} = (125-25^\circ\text{C})/0.6 \text{ W} = 167^\circ\text{C/W}$
	$\theta_{jc} = 30^\circ\text{C/W}$

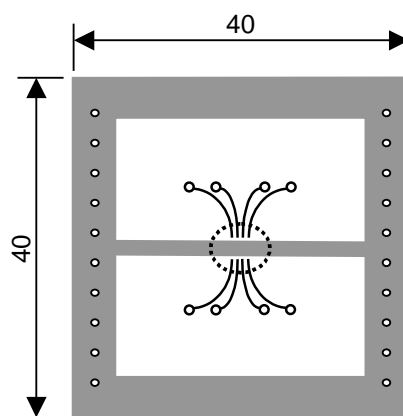
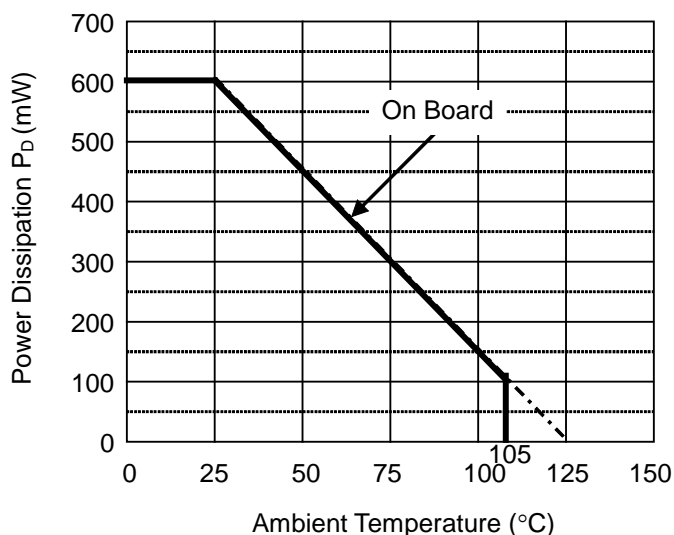

Measurement Board Pattern

IC Mount Area (Unit : mm)

Power Dissipation

RP111x-Y

NO.EA-375-200904

PACKAGE DIMENSIONS (DFN1212-6)

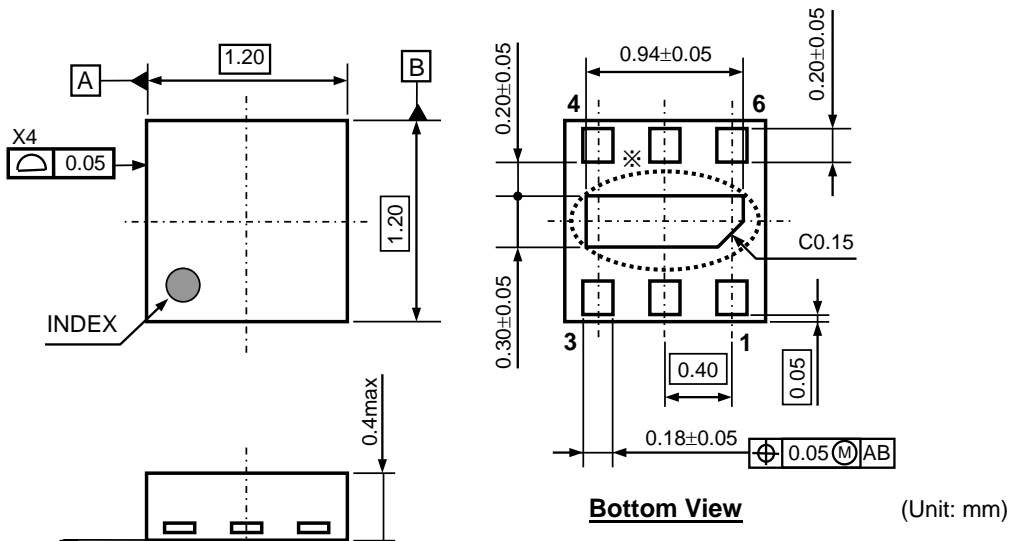

※) The tab on the bottom of the package enhances thermal performance and is electrically connected to GND (substrate level). It is recommended that the tab be connected to the ground plane on the board, or otherwise be left floating.

MARK SPECIFICATION (DFN1212-6)

- ①②: Product Code ... **Refer to MARK SPECIFICATION TABLE (DFN1212-6)**
- ③④: Lot Number ... Alphanumeric Serial Number

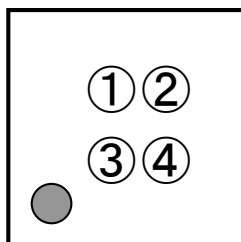

MARK SPECIFICATION TABLE (DFN1212-6)
RP111Lxx1B

Product Name	① ②	V _{SET}
RP111L071B	7 A	0.7 V
RP111L121B	7 G	1.2 V
RP111L151B	7 L	1.5 V
RP111L181B	7 P	1.8 V
RP111L251B	7 X	2.5 V
RP111L271B	7 Z	2.7 V
RP111L281B	8 A	2.8 V
RP111L301B	8 D	3.0 V
RP111L331B	8 G	3.3 V
RP111L341B	8 H	3.4 V

RP111Lxx1D

Product Name	① ②	V _{SET}
RP111L071D	9 A	0.7 V
RP111L121D	9 G	1.2 V
RP111L151D	9 L	1.5 V
RP111L181D	9 P	1.8 V
RP111L251D	9 X	2.5 V
RP111L271D	9 Z	2.7 V
RP111L281D	0 A	2.8 V
RP111L301D	0 D	3.0 V
RP111L331D	0 G	3.3 V
RP111L341D	0 H	3.4 V

POWER DISSIPATION (SOT-23-5)

Power Dissipation (P_D) depends on conditions of mounting on board. This specification is based on the measurement at the condition below (Power Dissipation (SOT-23-5) is substitution of SOT-23-6).

* Measurement Conditions

Standard Test Land Pattern	
Environment	Mounting on Board (Wind velocity = 0 m/s)
Board Material	Glass cloth epoxy plastic (Double sided)
Board Dimensions	40 mm*40 mm*1.6 mm
Copper Ratio	Top side: Approx. 50%, Back side: Approx. 50%
Through-holes	ϕ 0.5 mm * 44 pcs

* Measurement Result:

($T_a = 25^\circ\text{C}$, $T_{j\text{max}} = 125^\circ\text{C}$)

	Standard Land Pattern	Free Air
Power Dissipation	420 mW	250 mW
Thermal Resistance	$\theta_{ja} = (125-25^\circ\text{C})/0.42 \text{ W} = 238^\circ\text{C/W}$	400 $^\circ\text{C/W}$

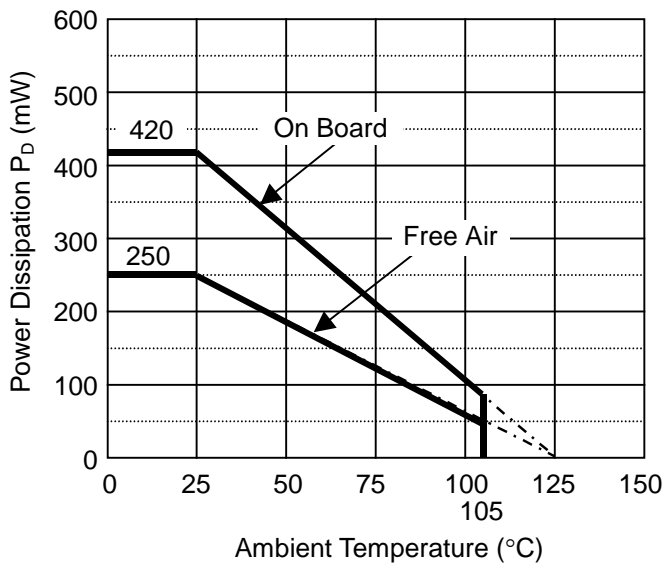

Power Dissipation

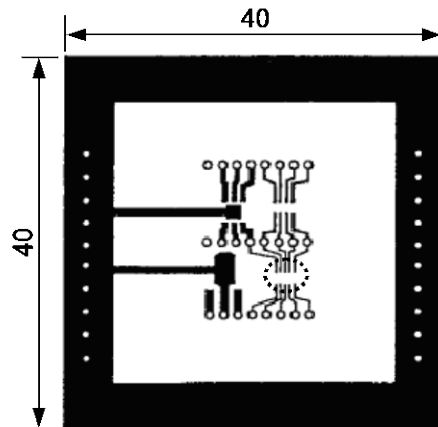

Measurement Board Pattern

IC Mount Area (Unit: mm)

PACKAGE DIMENSIONS (SOT-23-5)

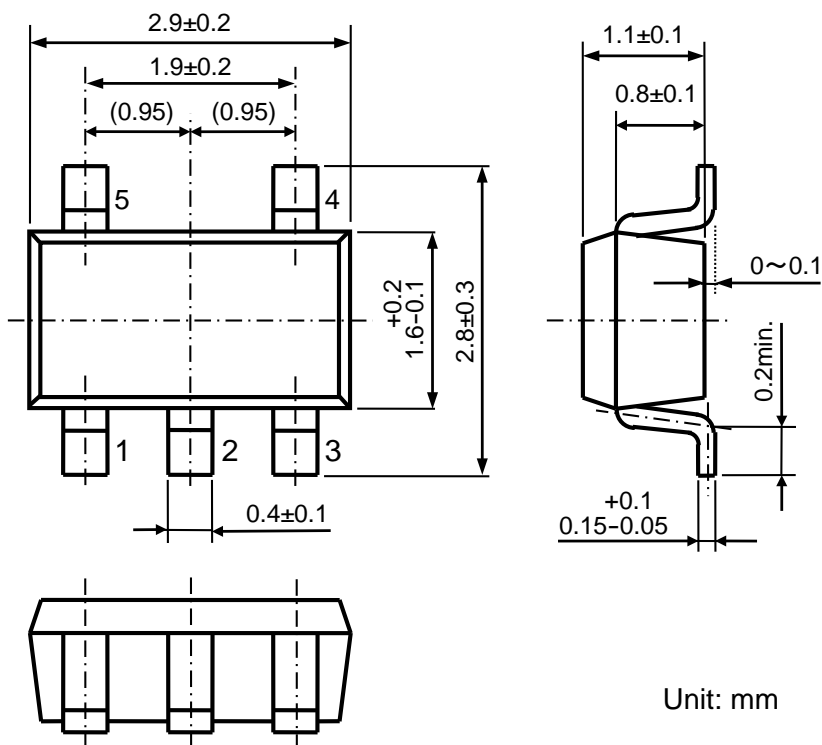

MARK SPECIFICATION (SOT-23-5)

- ①②③: Product Code ... **Refer to MARK SPECIFICATION TABLE (SOT-23-5)**
- ④⑤: Lot Number ... Alphanumeric Serial Number

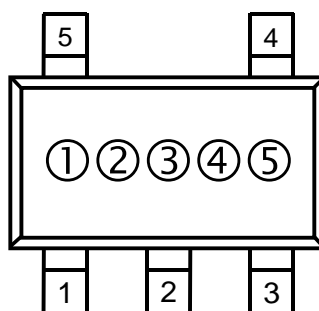

RP111x-YNO.EA-375-200904

MARK SPECIFICATION TABLE (SOT-23-5)**RP111Nxx1B**

Product Name	①	②	③	V _{SET}
RP111N071B	H	0	7	0.7 V
RP111N121B	H	1	2	1.2 V
RP111N151B	H	1	5	1.5 V
RP111N181B	H	1	8	1.8 V
RP111N251B	H	2	5	2.5 V
RP111N271B	H	2	7	2.7 V
RP111N281B	H	2	8	2.8 V
RP111N301B	H	3	0	3.0 V
RP111N331B	H	3	3	3.3 V
RP111N341B	H	3	4	3.4 V

RP111Nxx1D

Product Name	①	②	③	V _{SET}
RP111N071D	J	0	7	0.7 V
RP111N121D	J	1	2	1.2 V
RP111N151D	J	1	5	1.5 V
RP111N181D	J	1	8	1.8 V
RP111N251D	J	2	5	2.5 V
RP111N271D	J	2	7	2.7 V
RP111N281D	J	2	8	2.8 V
RP111N301D	J	3	0	3.0 V
RP111N331D	J	3	3	3.3 V
RP111N341D	J	3	4	3.4 V

POWER DISSIPATION (SOT-89-5)

Power Dissipation (P_D) depends on conditions of mounting on board. This specification is based on the measurement at the condition below.

Measurement Conditions

	High Wattage Land Pattern	Standard Land Pattern
Environment	Mounting on Board (Wind velocity = 0 m/s)	Mounting on Board (Wind velocity = 0 m/s)
Board Material	Glass cloth epoxy plastic (Double sided)	Glass cloth epoxy plastic (Double sided)
Board Dimensions	30 mm × 30 mm × 1.6 mm	50 mm × 50 mm × 1.6 mm
Copper Ratio	Top side: Approx. 20%, Back side: Approx. 100%	Top side: Approx. 10%, Back side: Approx. 100%
Through-hole	φ0.85 mm × 10 pcs	-

Measurement Result

($T_a = 25^\circ\text{C}$, $T_{jmax} = 125^\circ\text{C}$)

	High Wattage Land Pattern	Standard Land Pattern	Free Air
Power Dissipation	1300 mW	900 mW	500 mW
Thermal Resistance	77°C/W	111°C /W	200°C /W

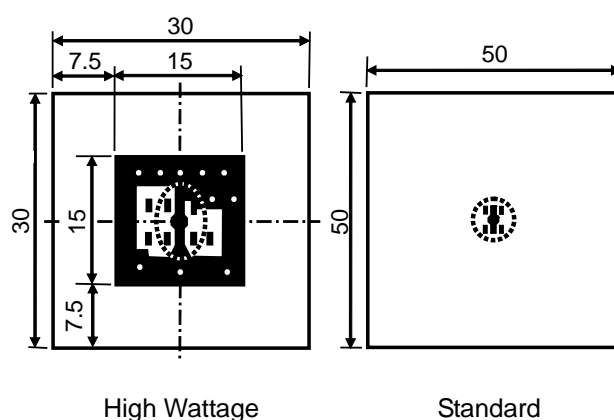
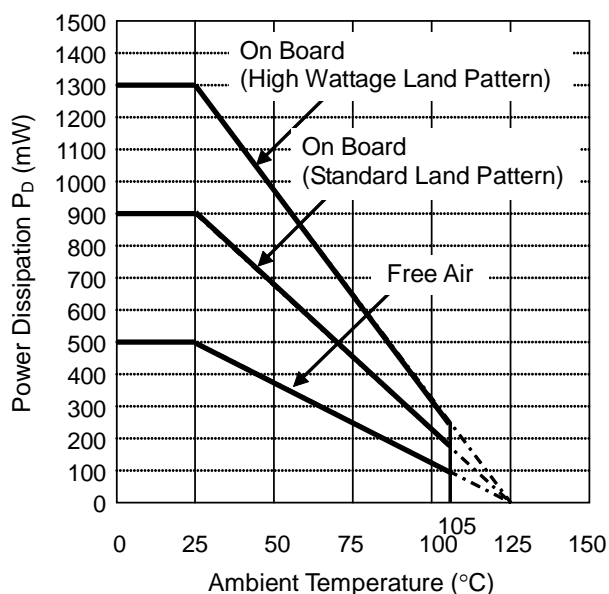

Measurement Board Pattern

○ IC Mount Area (Unit: mm)

Power Dissipation

RP111x-Y

NO.EA-375-200904

PACKAGE DIMENSIONS (SOT-89-5)

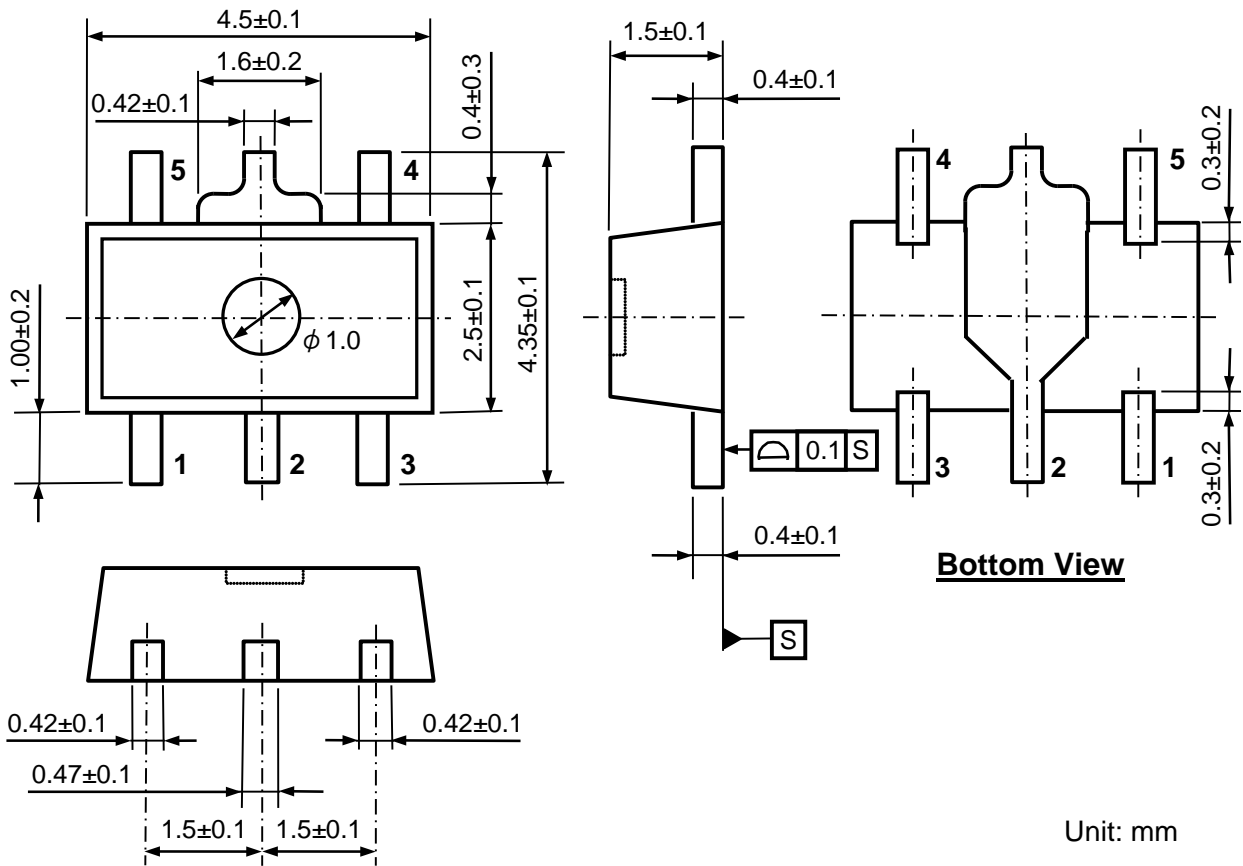

Unit: mm

MARK SPECIFICATION (SOT-89-5)

①②③④: Product Code ... **Refer to MARK SPECIFICATION TABLE (SOT-89-5)**

⑤⑥: Lot Number ... Alphanumeric Serial Number

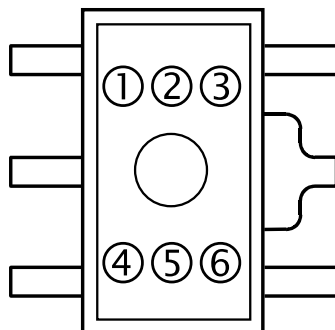

MARK SPECIFICATION TABLE (SOT-89-5)
RP111Hxx1B

Product Name	① ② ③ ④	V _{SET}
RP111H071B	A 0 7 B	0.7 V
RP111H121B	A 1 2 B	1.2 V
RP111H151B	A 1 5 B	1.5 V
RP111H181B	A 1 8 B	1.8 V
RP111H251B	A 2 5 B	2.5 V
RP111H271B	A 2 7 B	2.7 V
RP111H281B	A 2 8 B	2.8 V
RP111H301B	A 3 0 B	3.0 V
RP111H331B	A 3 3 B	3.3 V
RP111H341B	A 3 4 B	3.4 V

RP111Hxx1D

Product Name	① ② ③ ④	V _{SET}
RP111H071D	A 0 7 D	0.7 V
RP111H121D	A 1 2 D	1.2 V
RP111H151D	A 1 5 D	1.5 V
RP111H181D	A 1 8 D	1.8 V
RP111H251D	A 2 5 D	2.5 V
RP111H271D	A 2 7 D	2.7 V
RP111H281D	A 2 8 D	2.8 V
RP111H301D	A 3 0 D	3.0 V
RP111H331D	A 3 3 D	3.3 V
RP111H341D	A 3 4 D	3.4 V

■ 特性例

※以下の特性例は参考値であり、それぞれの値を保証するものではありません。

1) Output Voltage vs. Output Current (C1 = Ceramic 1.0 μ F, C2 = Ceramic 1.0 μ F, Ta = 25°C)

RP111x071x

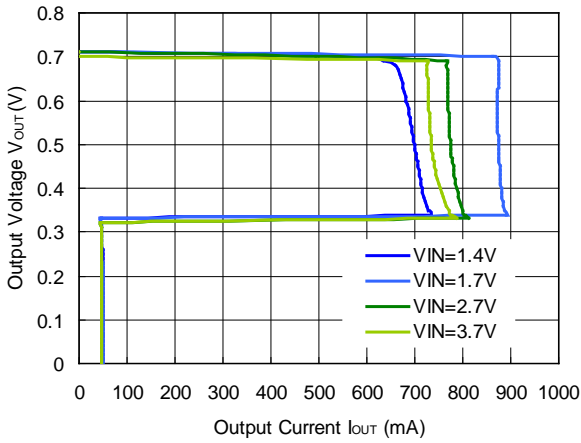

RP111x171x

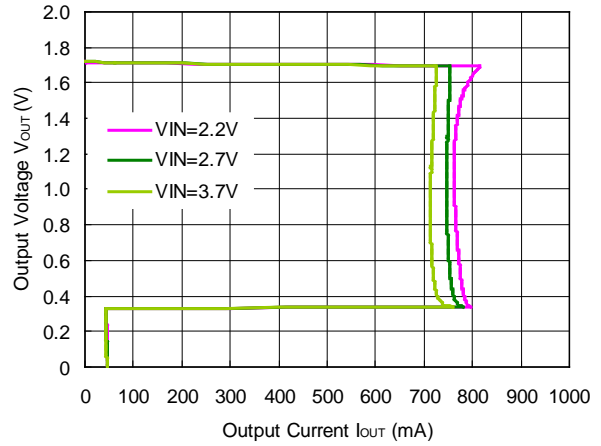

RP111x181x

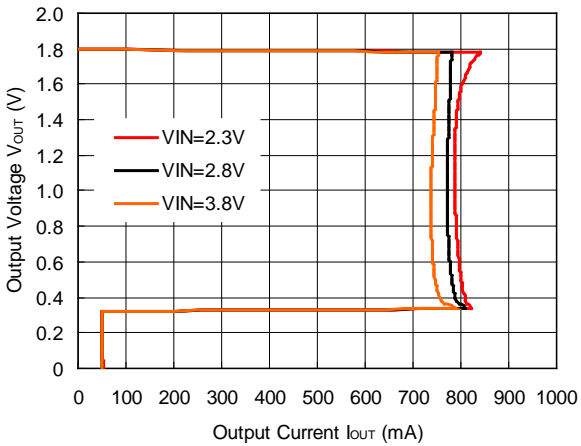

RP111x281x

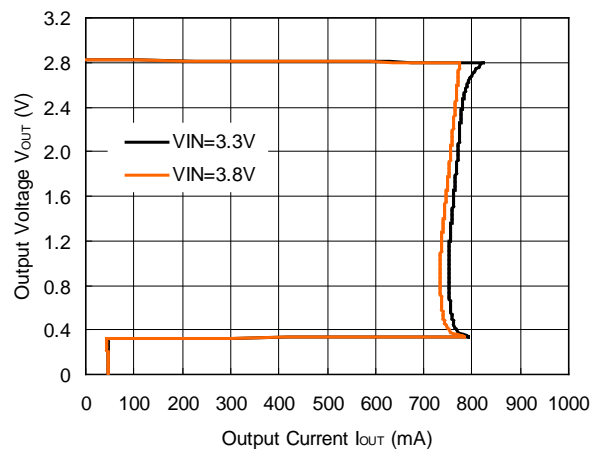

RP111x361x

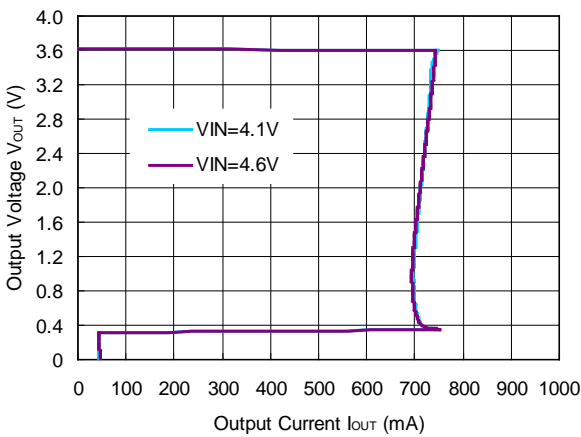

2) Output Voltage vs. Input Voltage (C1 = Ceramic 1.0 μ F, C2 = Ceramic 1.0 μ F, Ta = 25°C)

RP111x071x

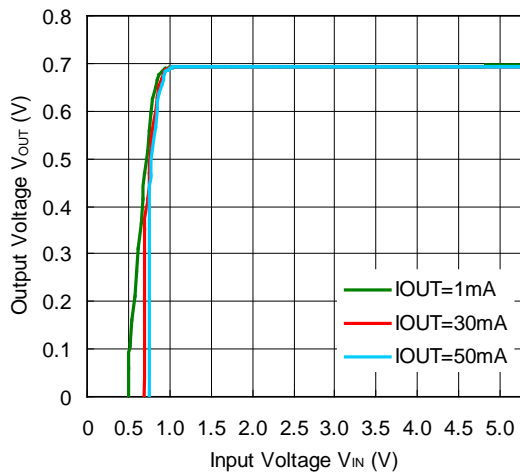

RP111x171x

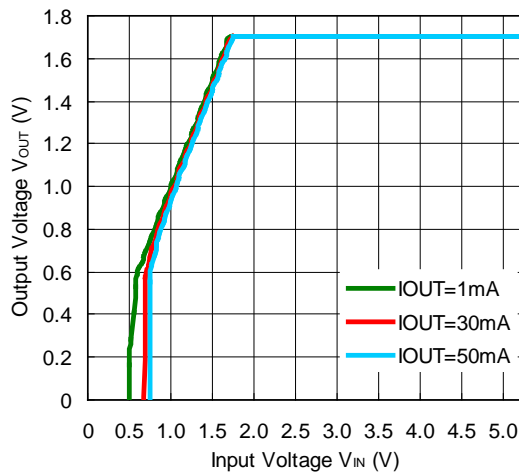

RP111x181x

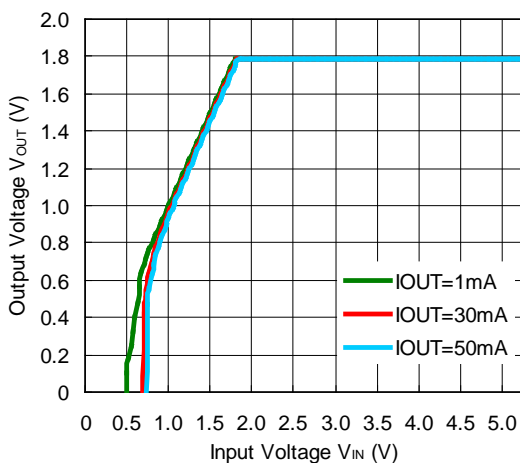

RP111x281x

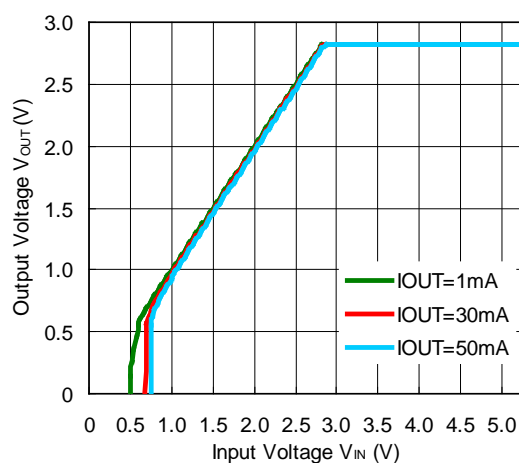

RP111x361x

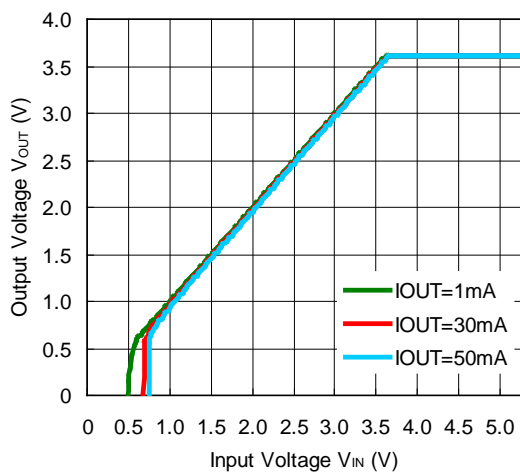

3) Supply Current vs. Input Voltage (C1 = Ceramic 1.0 μ F, C2 = Ceramic 1.0 μ F, Ta = 25°C)

RP111x071x

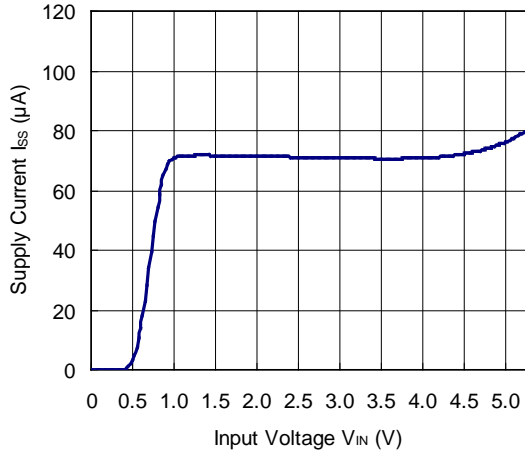

RP111x171x

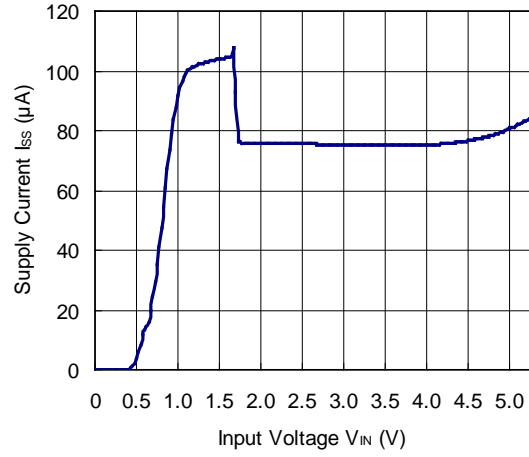

RP111x181x

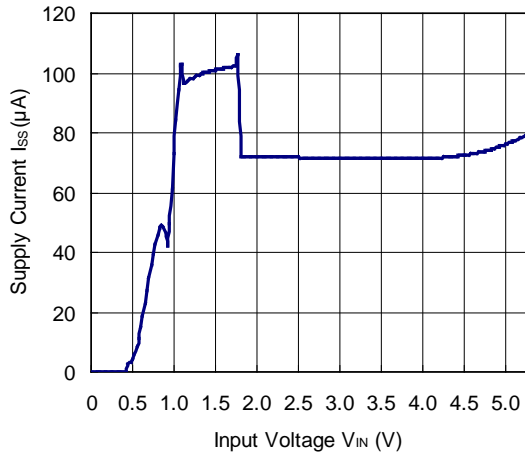

RP111x281x

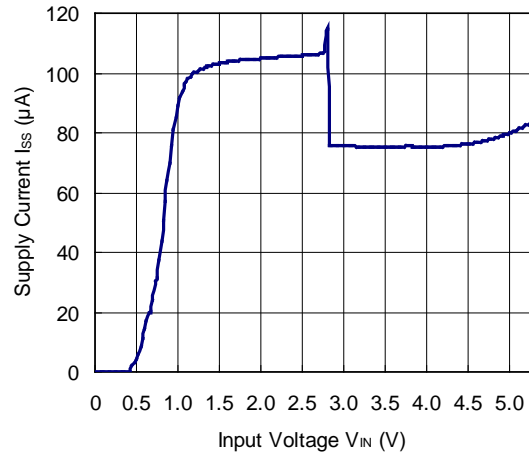

RP111x361x

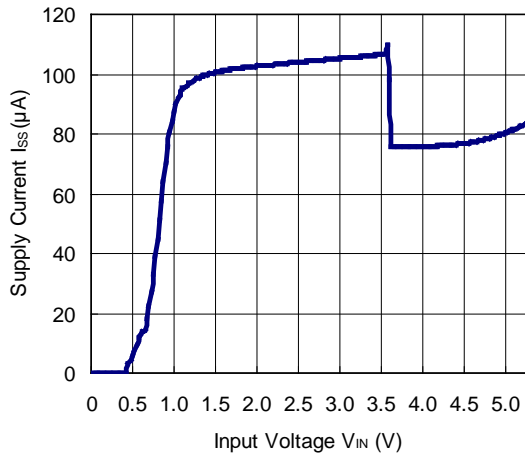

4) Output Voltage vs. Temperature (C1 = Ceramic 1.0 μ F, C2 = Ceramic 1.0 μ F, I_{OUT} = 1 mA)

RP111x071x

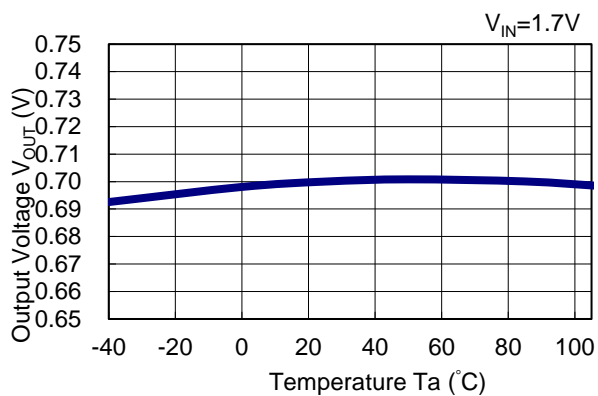

RP111x171x

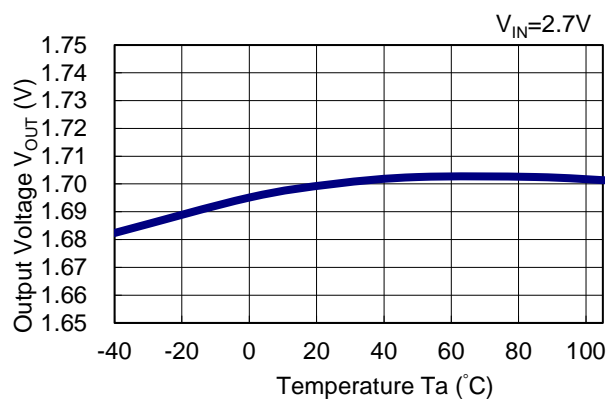

RP111x181x

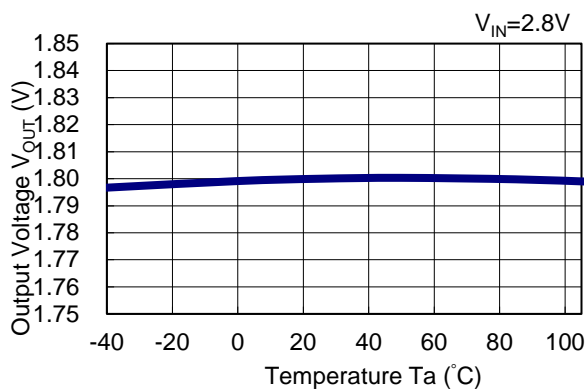

RP111x281x

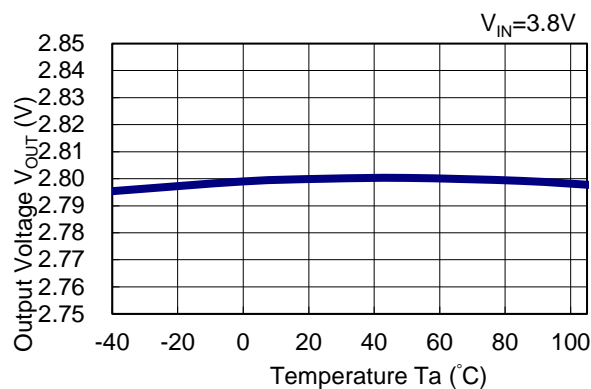

RP111x361x

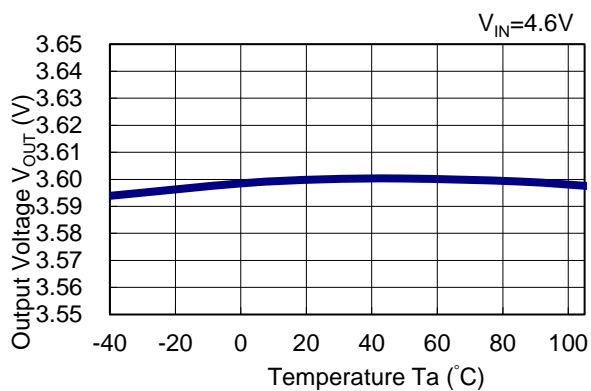

RP111x-YNO.EA-375-200904

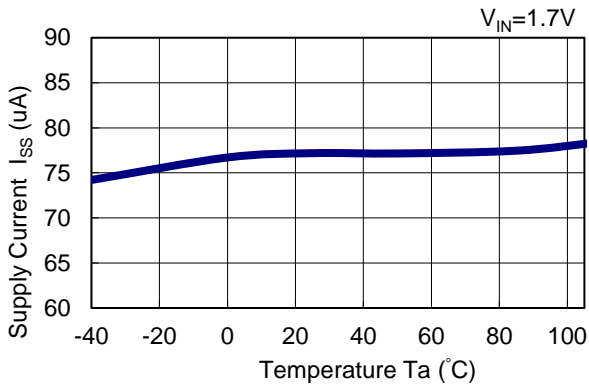
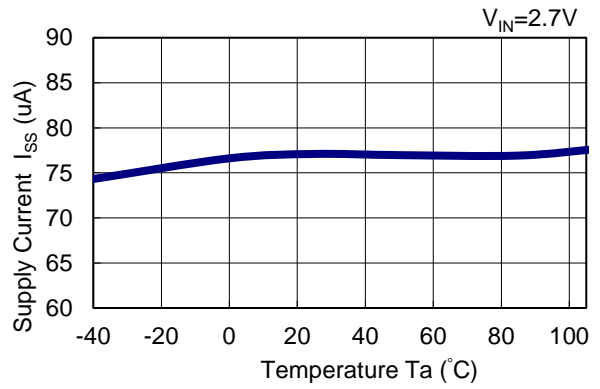
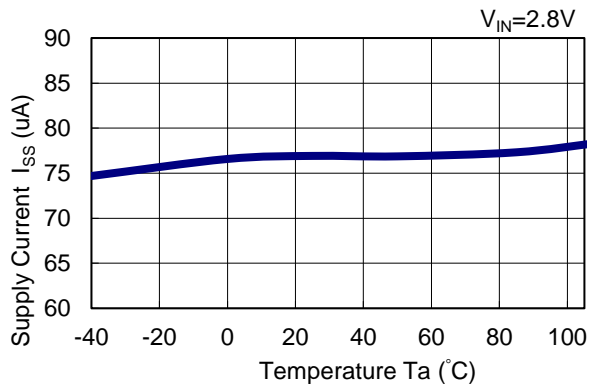
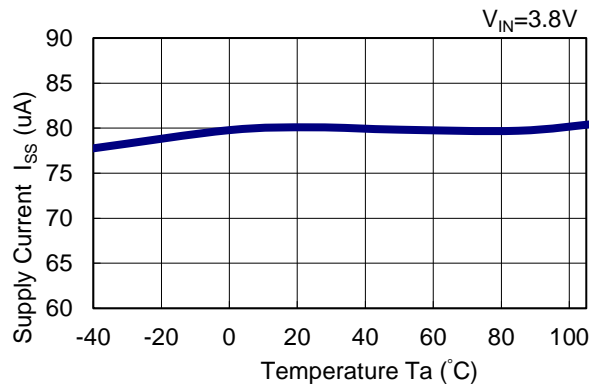
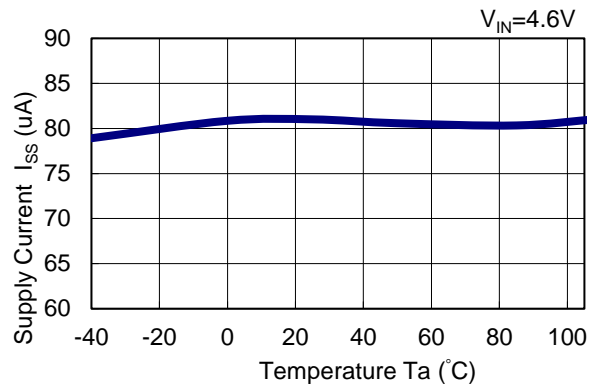
5) Supply Current vs. Temperature (C1 = Ceramic 1.0 μ F, C2 = Ceramic 1.0 μ F, I_{OUT} = 0 mA)**RP111x071x****RP111x171x****RP111x181x****RP111x281x****RP111x361x**

6) Dropout Voltage vs. Output Current (C1 = Ceramic 1.0 μ F, C2 = Ceramic 1.0 μ F)

RP111x071x

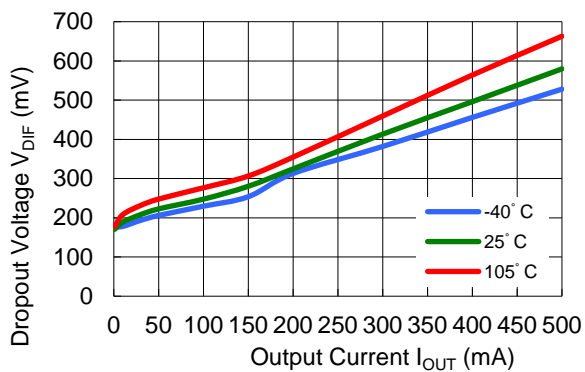

RP111x171x

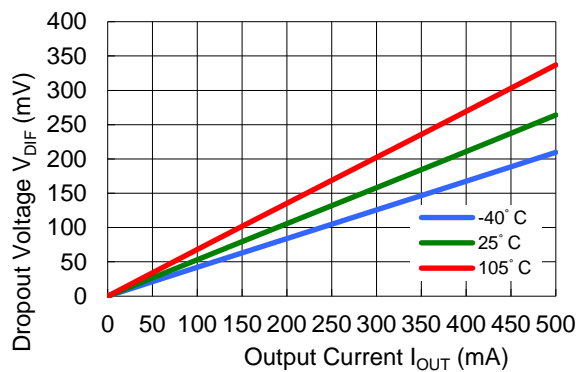

RP111x181x

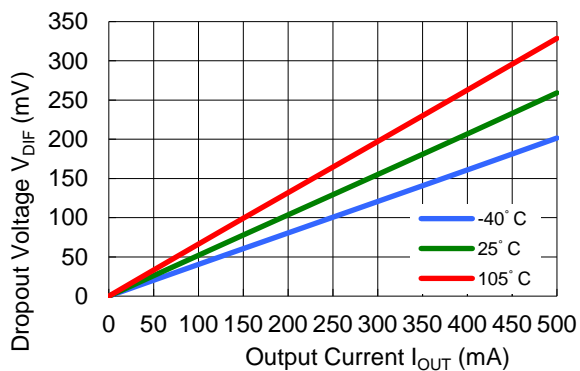

RP111x281x

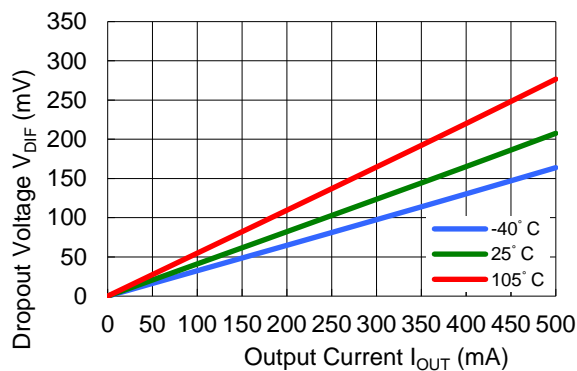

RP111x361x

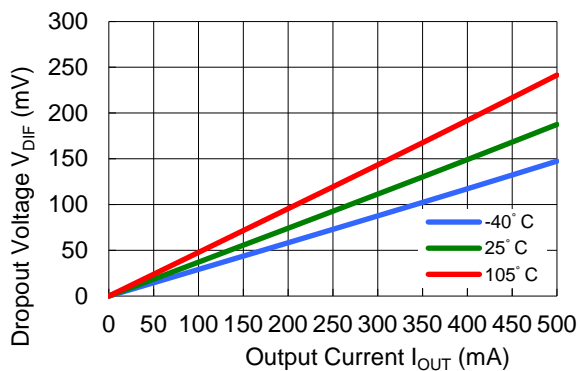

RP111x-Y

NO.EA-375-200904

7) Dropout Voltage vs. Set Output Voltage (C1 = Ceramic 1.0 μ F, C2 = Ceramic 1.0 μ F, Ta = 25°C)

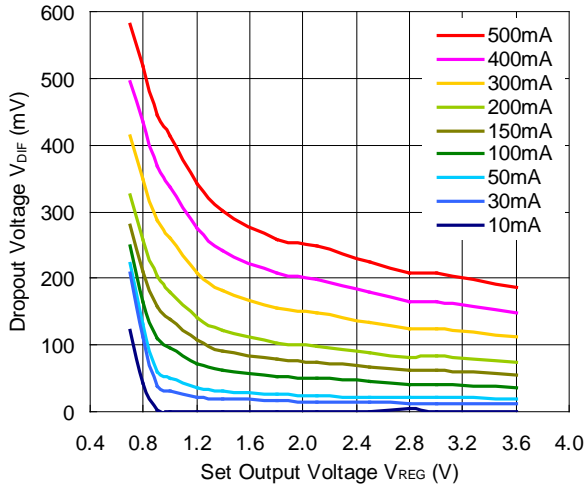

8) Dropout Voltage vs. Temperature (C1 = Ceramic 1.0 μ F, C2 = Ceramic 1.0 μ F)

RP111x071x

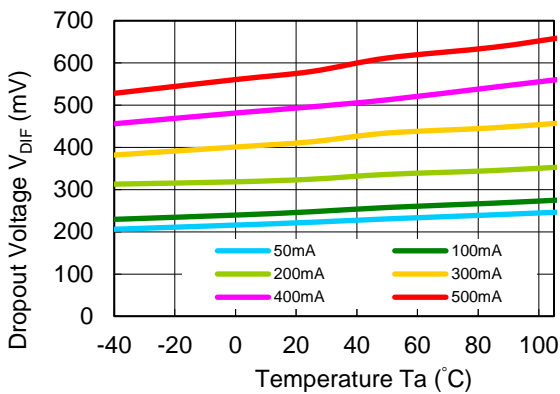

RP111x171xx

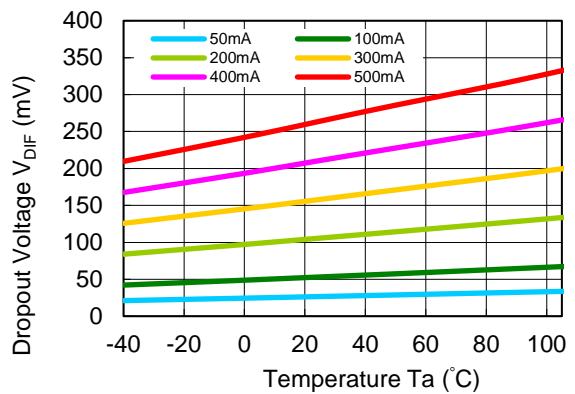

RP111x181x

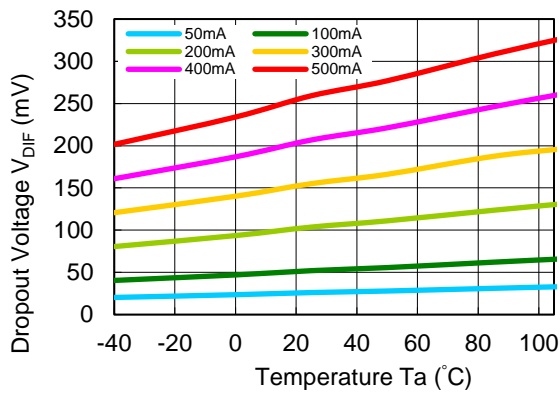

RP111x281x

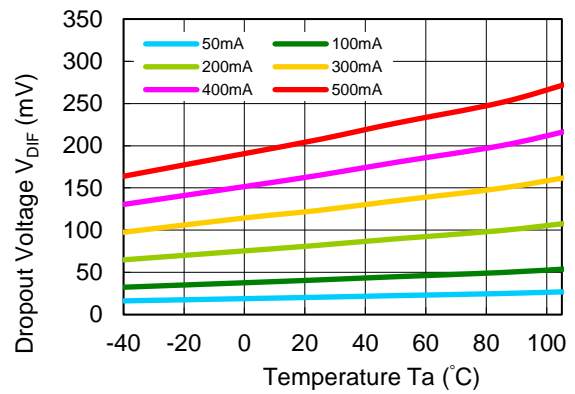

RP111x361x

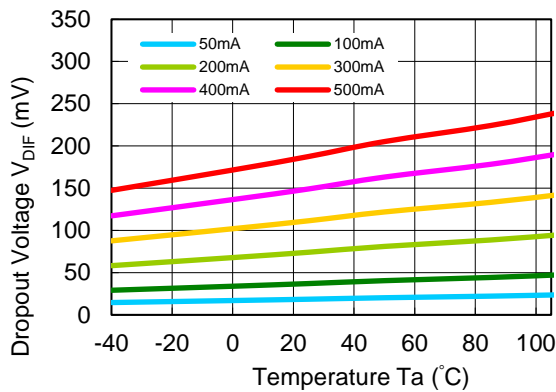

9) Ripple Rejection vs. Input Voltage (C1 = none, C2 = Ceramic 1.0 μF, Ripple = 0.2 V p-p, Ta = 25°C)

RP111x071x

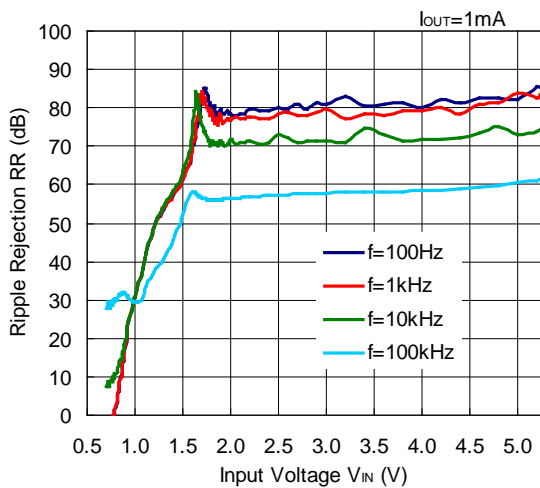

RP111x071x

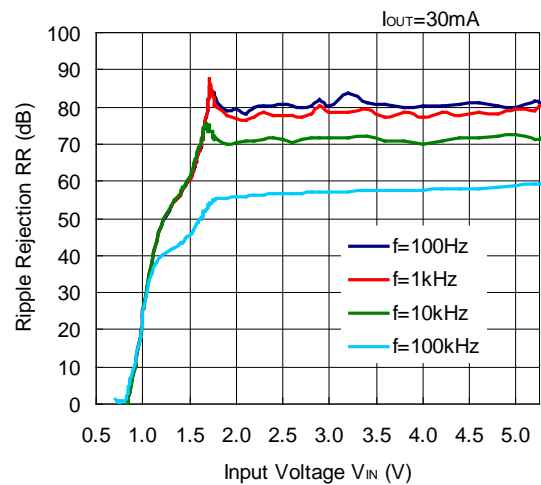

RP111x171x

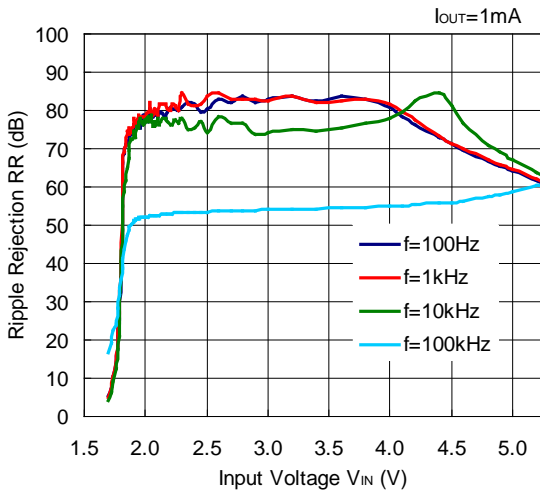

RP111x171x

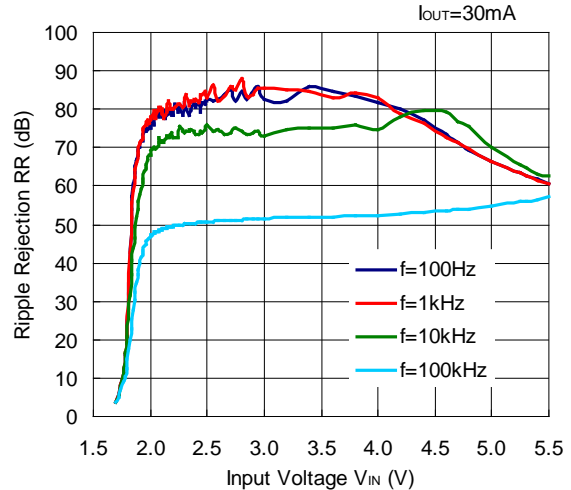

RP111x181x

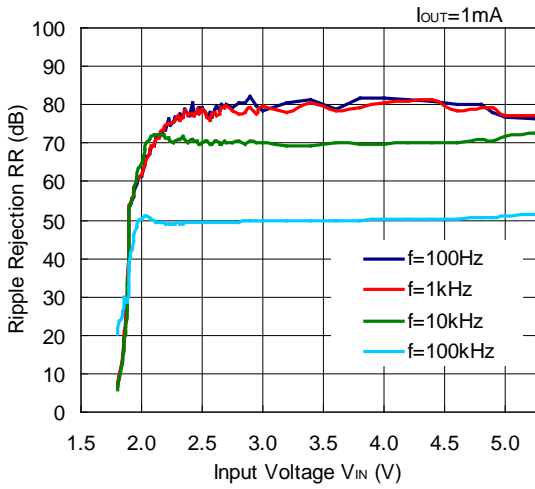

RP111x181x

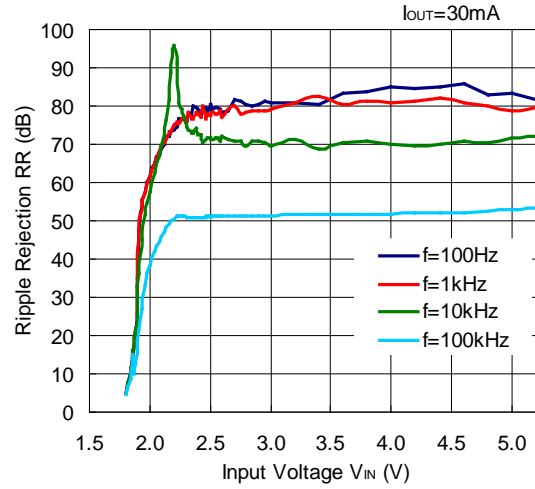

RP111x281x

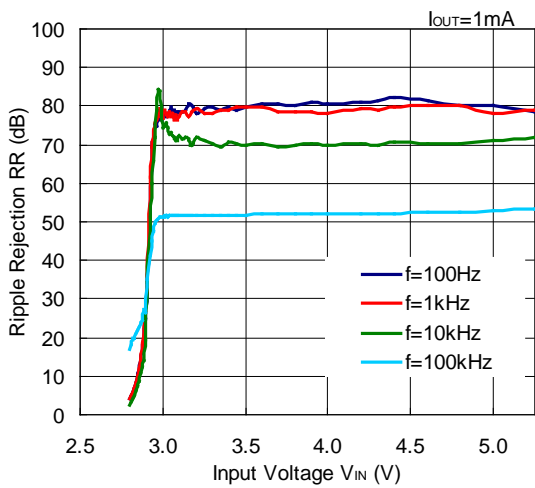

RP111x281x

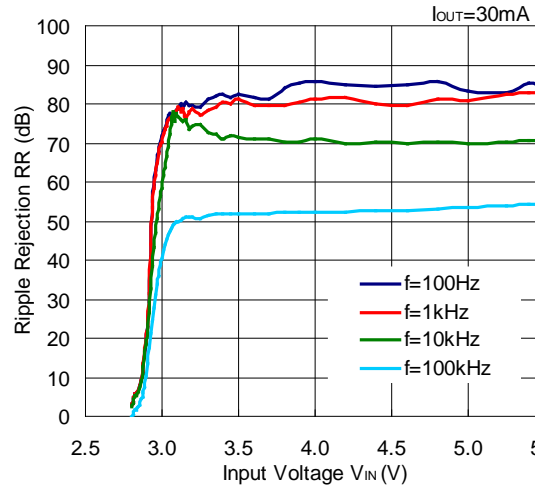

RP111x361x

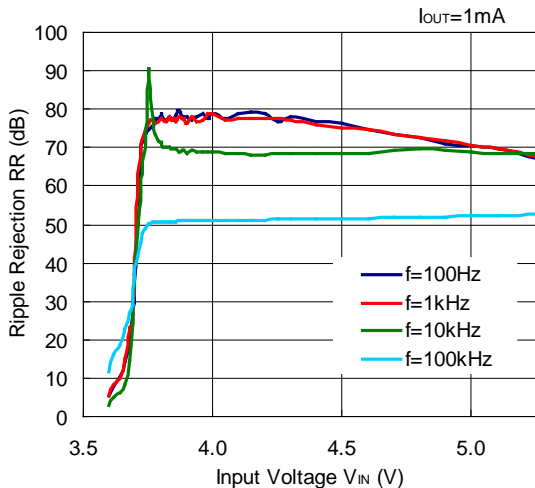

RP111x361x

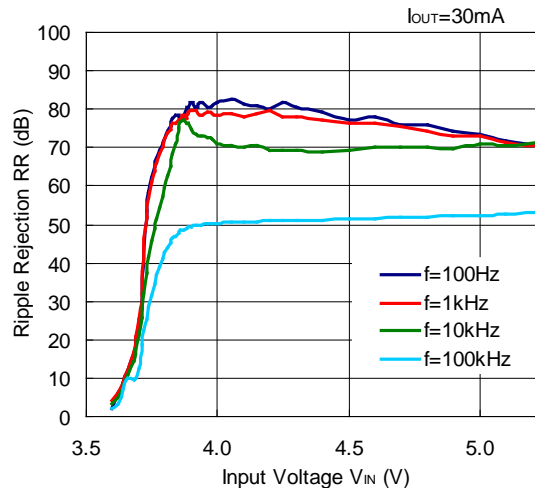

10) Ripple Rejection vs. Frequency (C1 = none, C2 = Ceramic 1.0 μ F, Ripple = 0.2 Vp-p, Ta = 25°C)

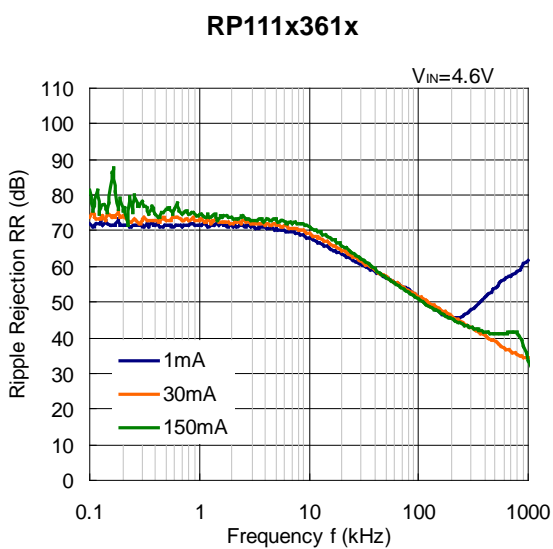
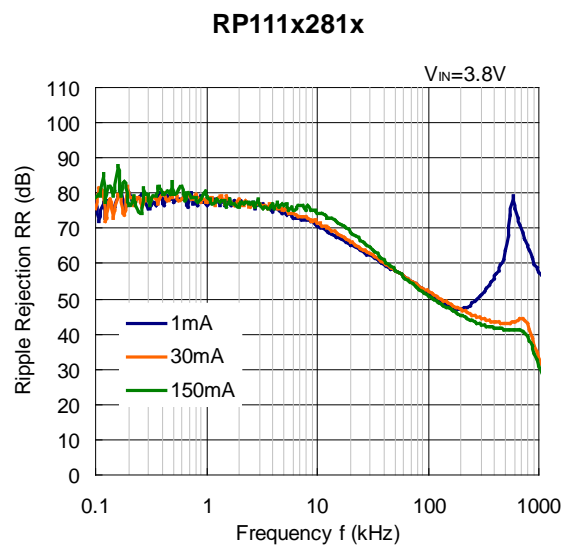
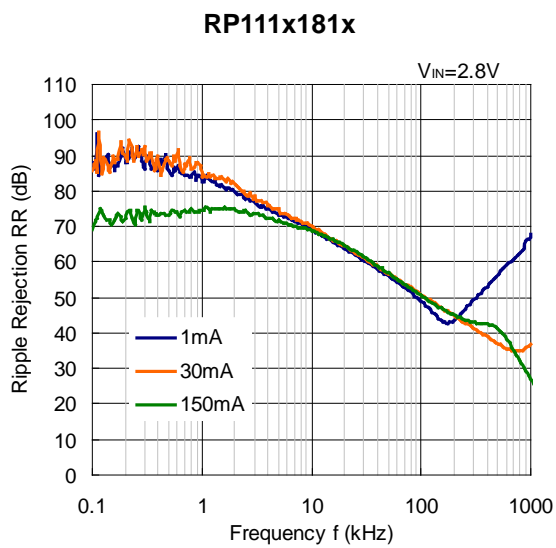
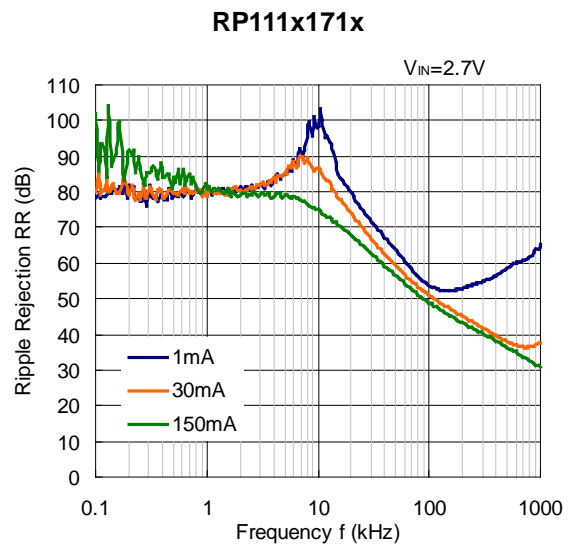
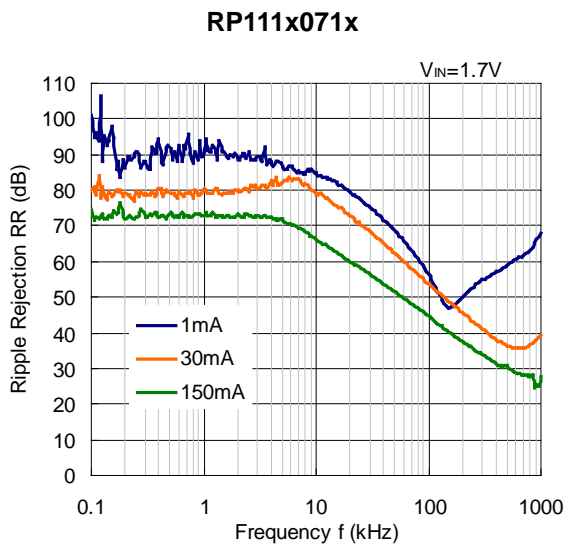

RP111x-Y

NO.EA-375-200904

11) Input Transient Response (C1= none, C2 = Ceramic 1.0 μ F, I_{OUT} = 30 mA, tr = tf = 5 μ s, Ta = 25°C)

RP111x071x

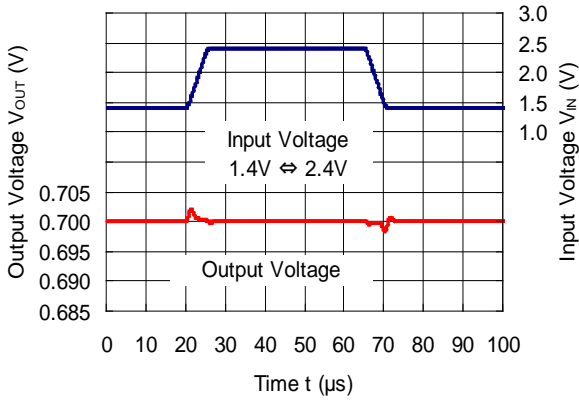

RP111x171x

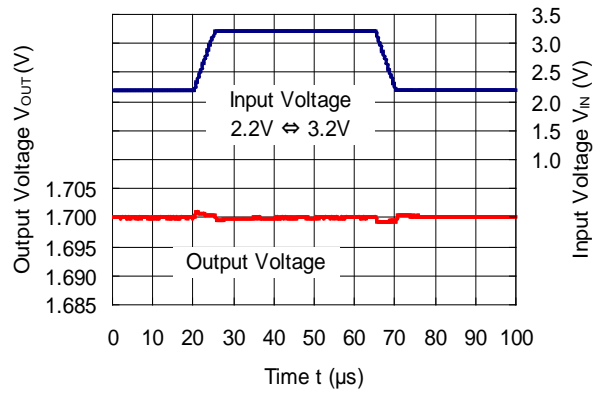

RP111x181x

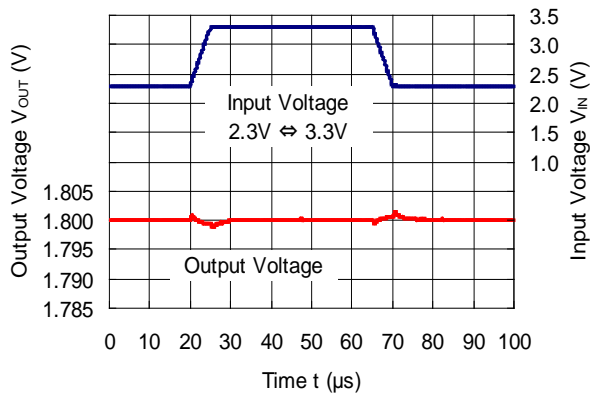

RP111x281x

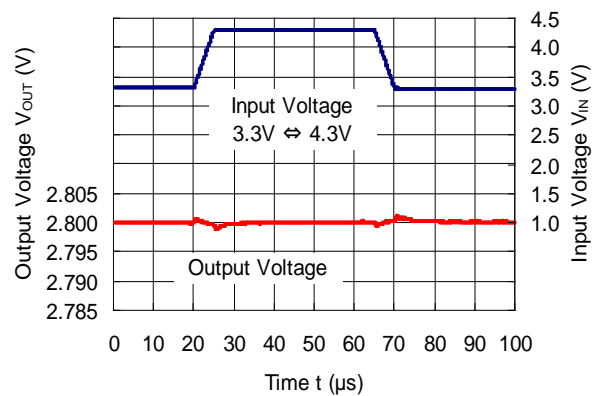

RP111x361x

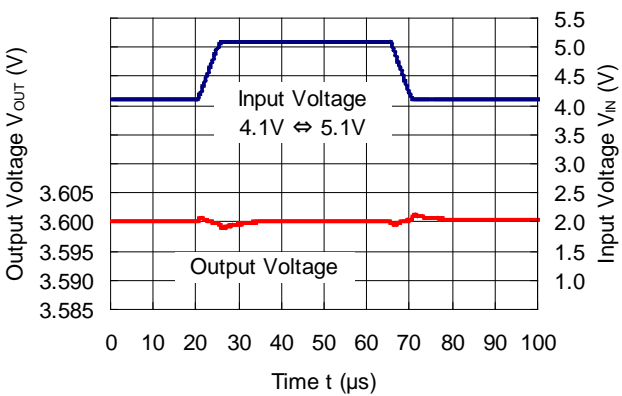

12) Load Transient Response (C1 = Ceramic 1.0 μ F, C2 = Ceramic 1.0 μ F, Ta = 25°C)

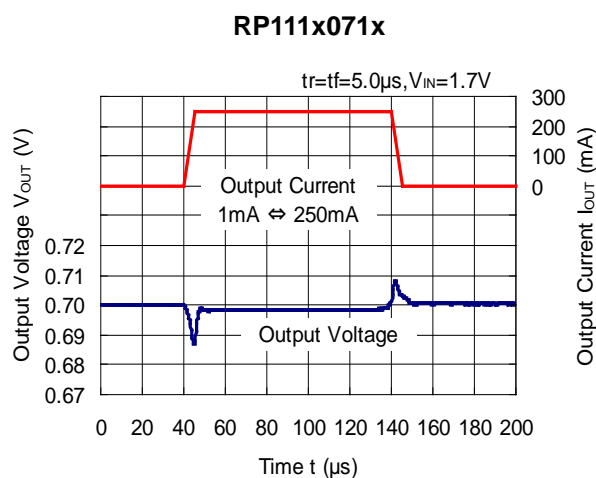
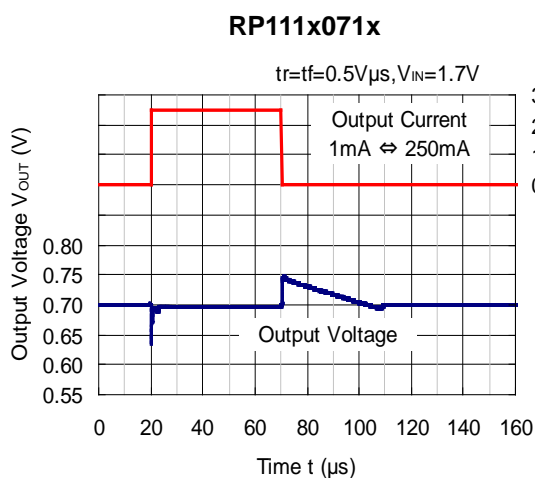
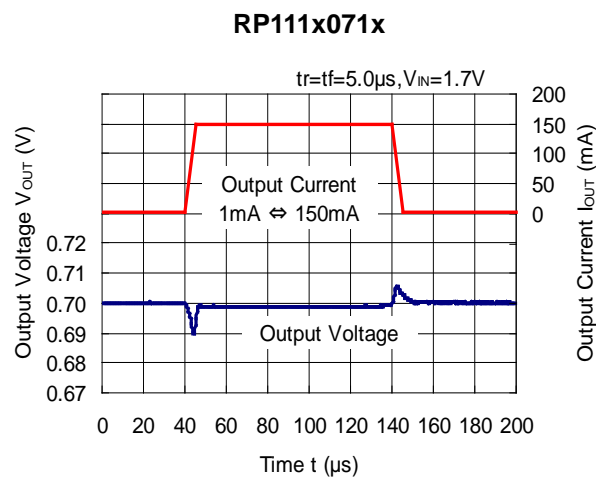
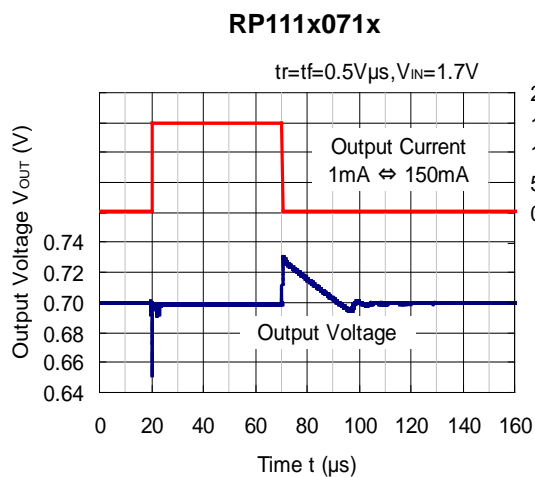
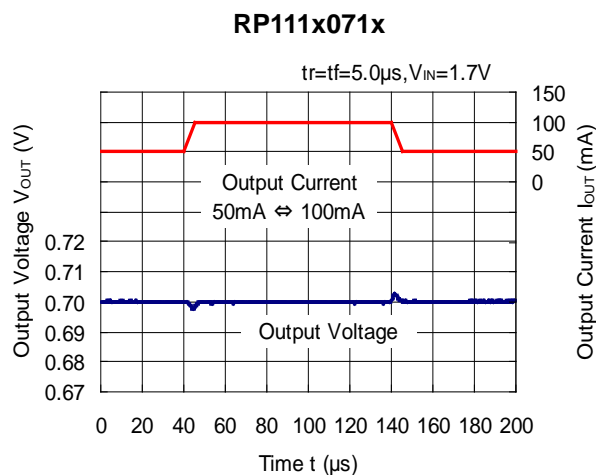
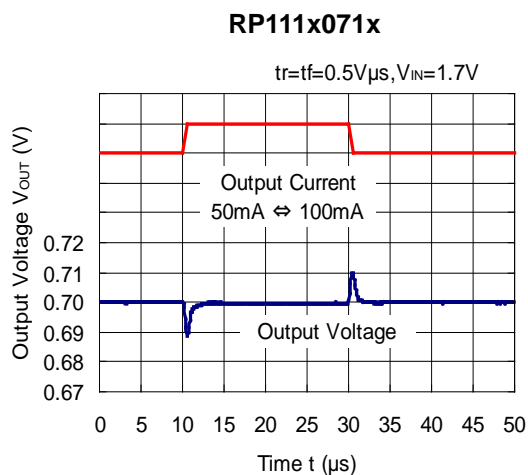

RP111x171x

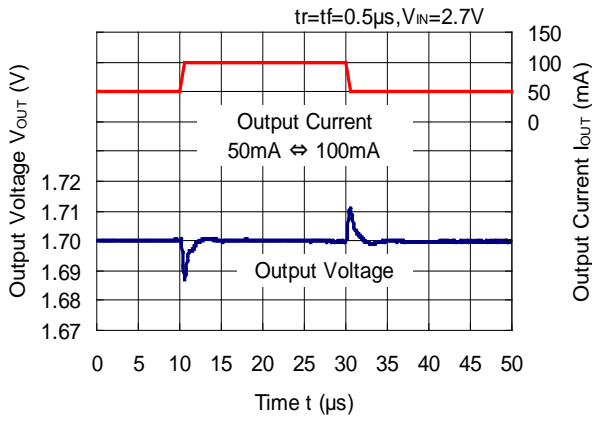

RP111x171x

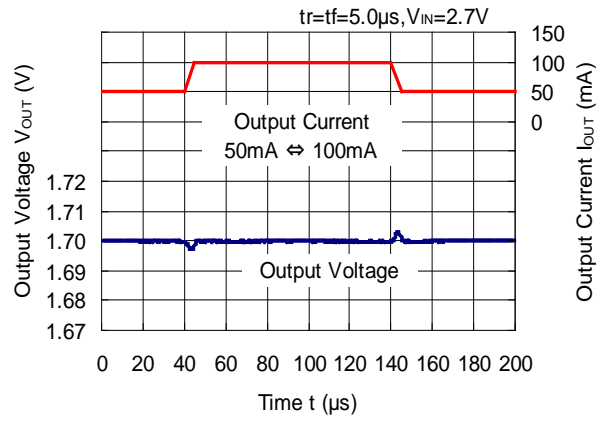

RP111x171x

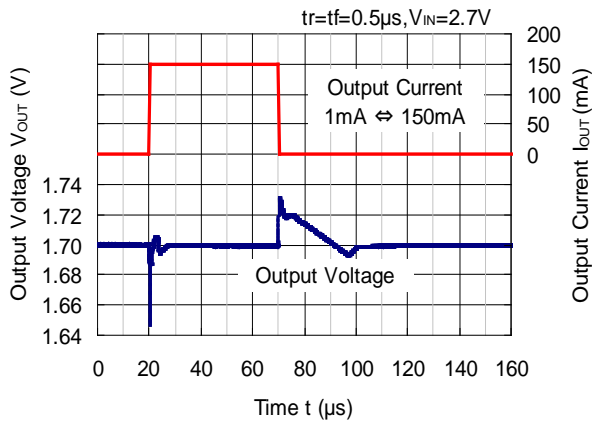

RP111x171x

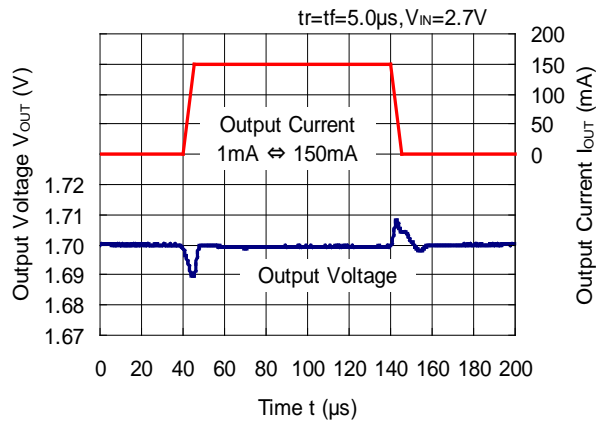

RP111x171x

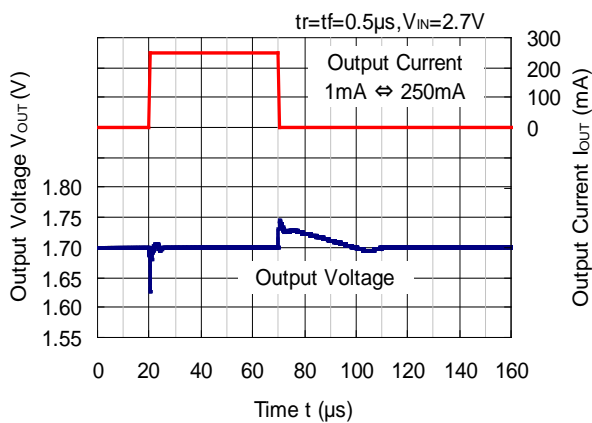

RP111x171x

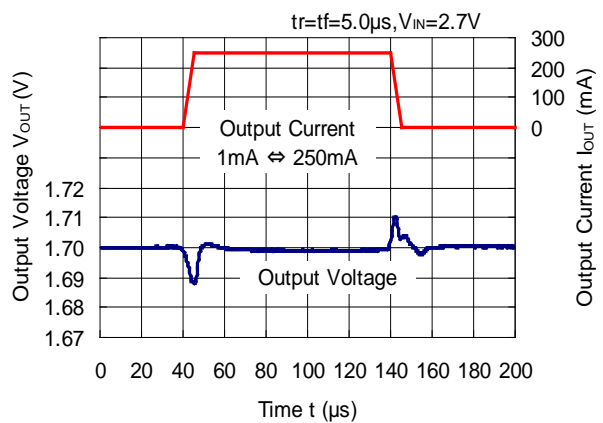

RP111x181x

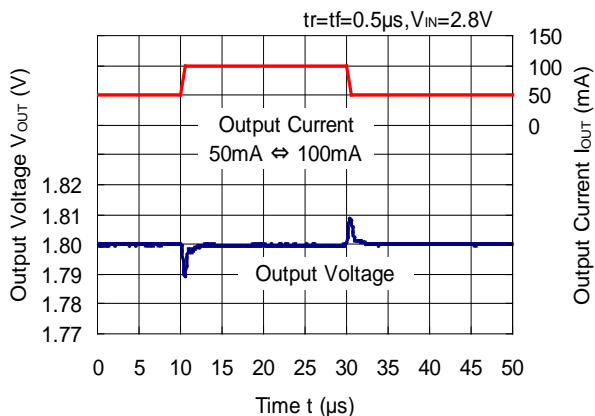

RP111x181x

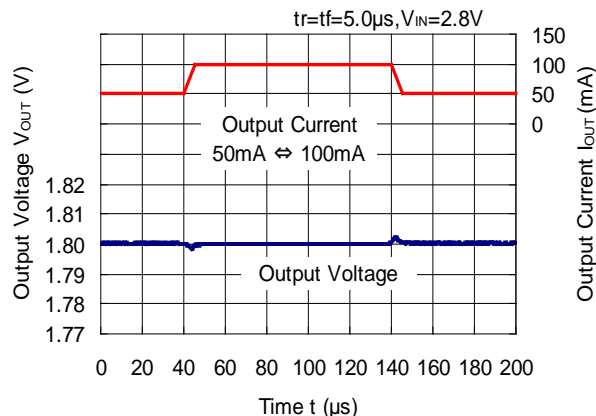

RP111x181x

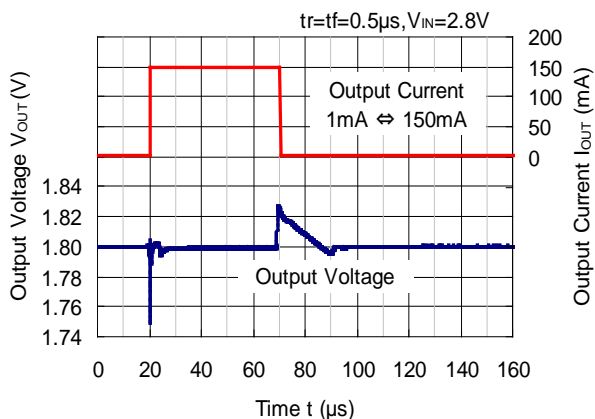

RP111x181x

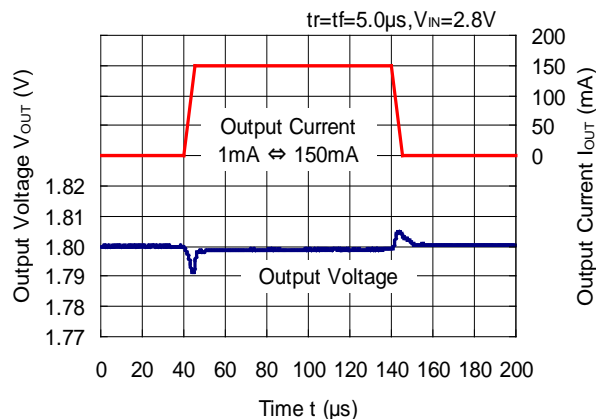

RP111x181x

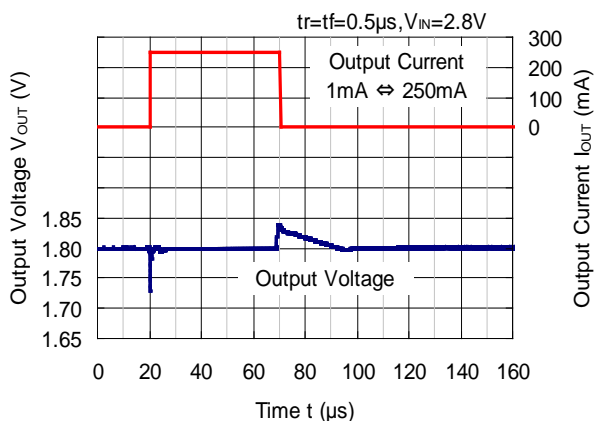

RP111x181x

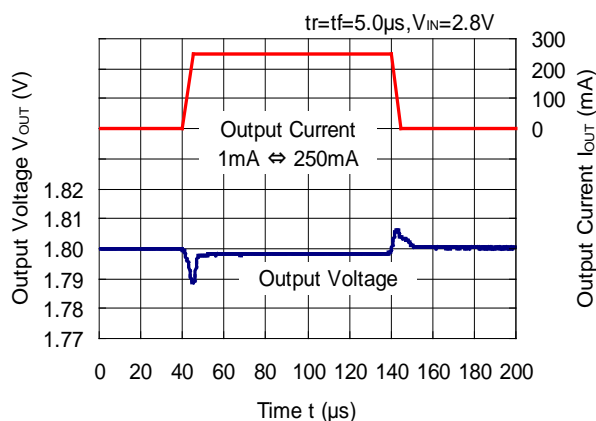

RP111x-Y

NO.EA-375-200904

RP111x281x

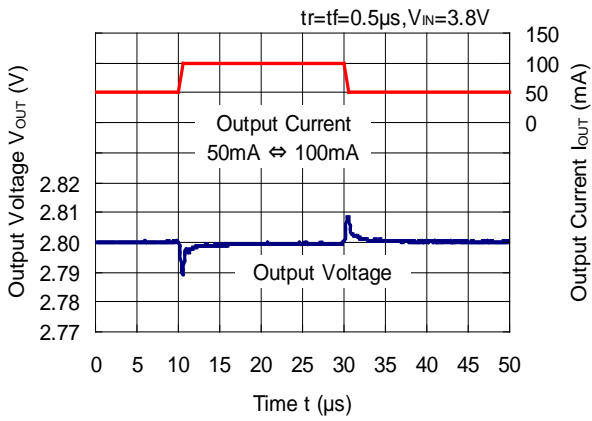

RP111x281x

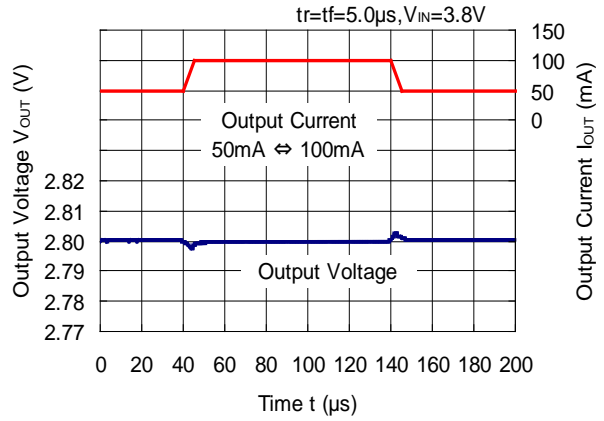

RP111x281x

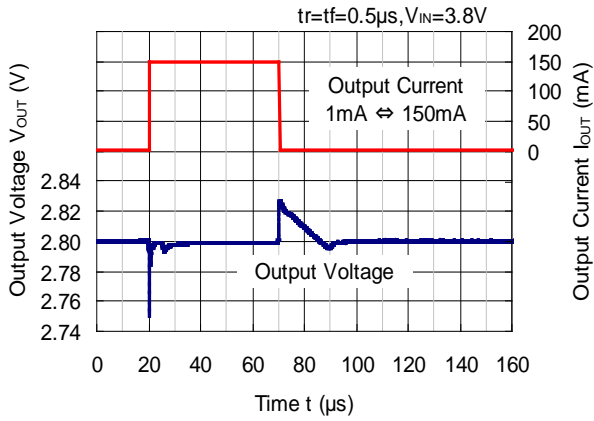

RP111x281x

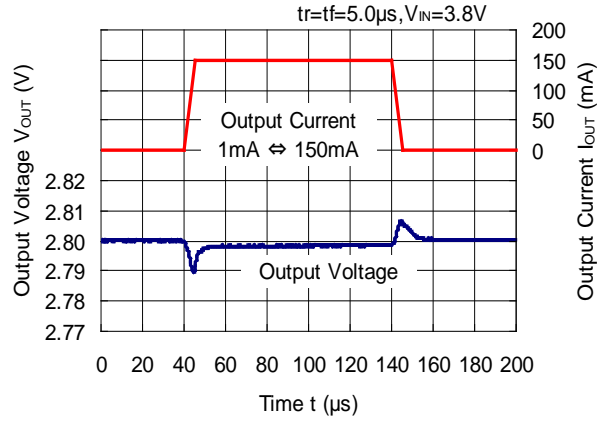

RP111x281x

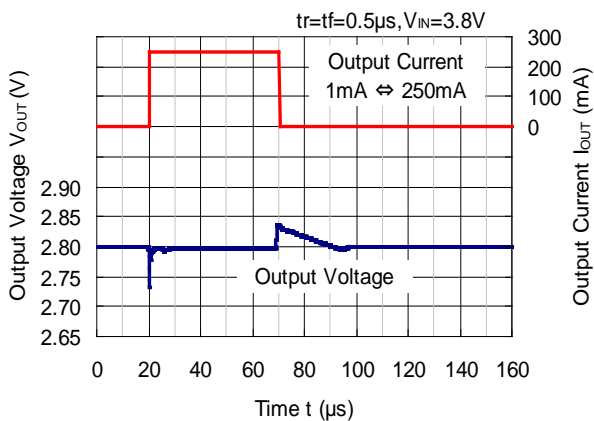

RP111x281x

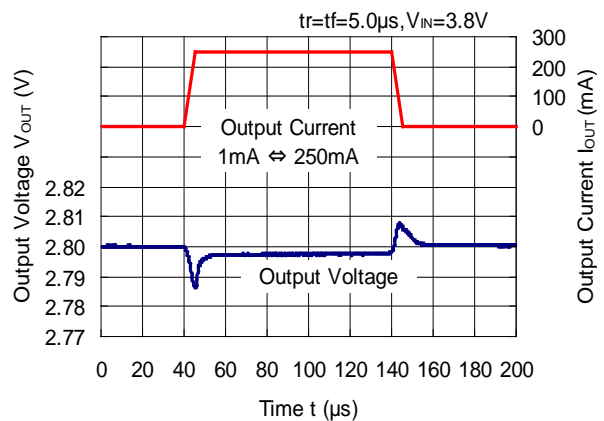

RP111x361x

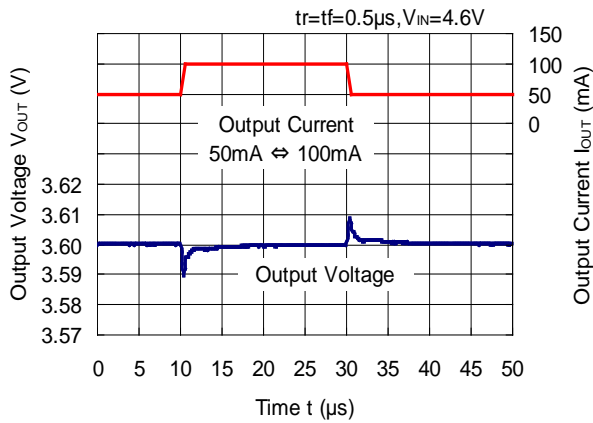

RP111x361x

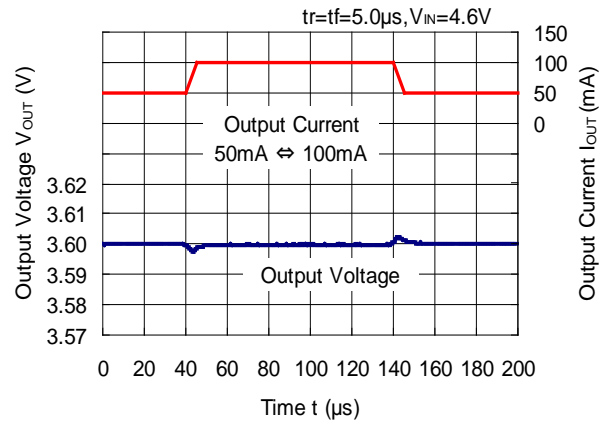

RP111x361x

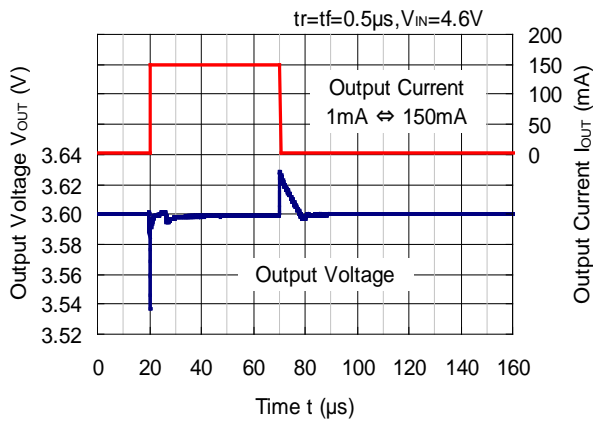

RP111x361x

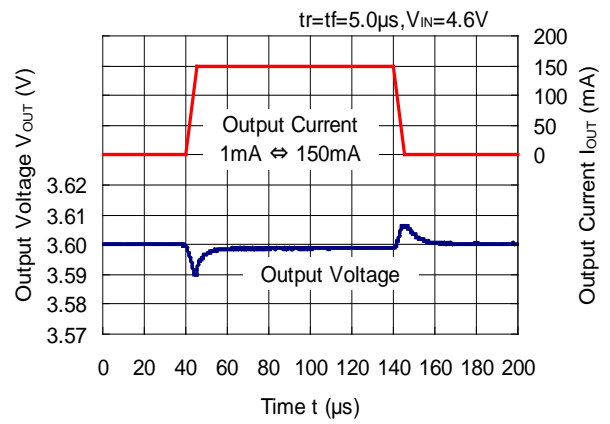

RP111x361x

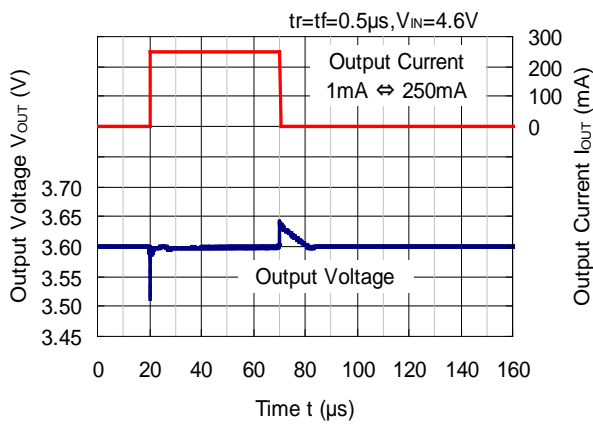

RP111x361x

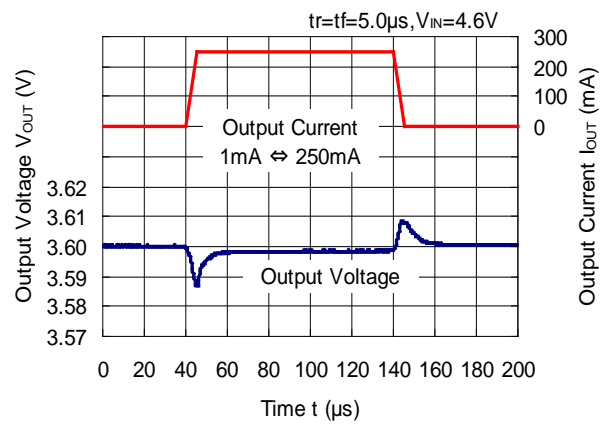

13) Turn on Speed with CE pin (C1 = Ceramic 1.0 μ F, C2 = Ceramic 1.0 μ F, Ta = 25°C)

RP111x071x

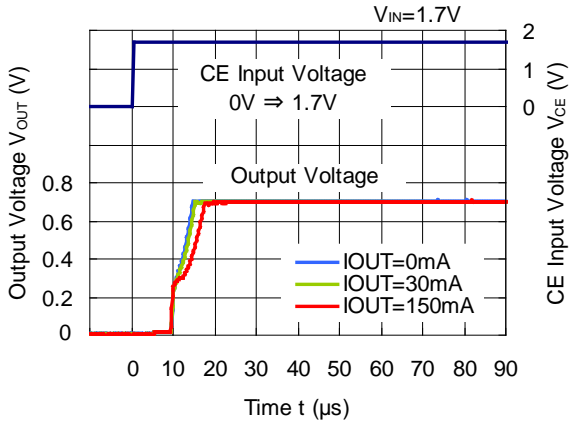

RP111x171x

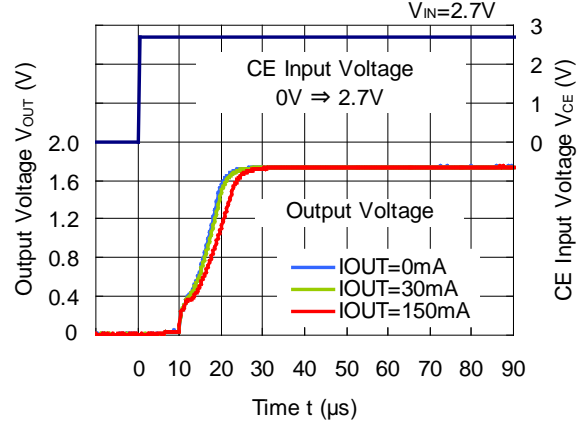

RP111x181x

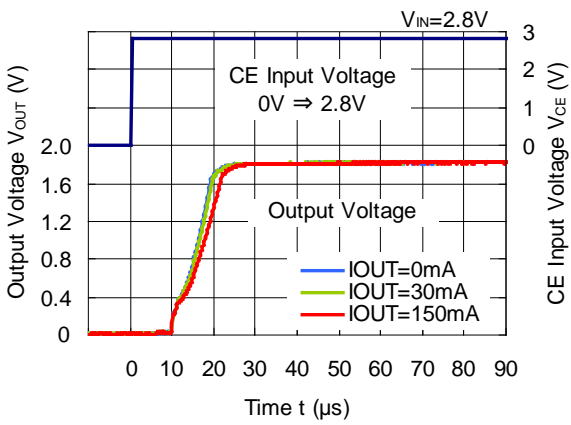

RP111x281x

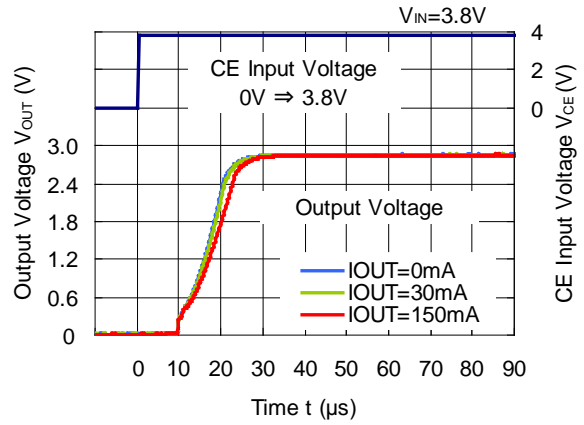

RP111x361

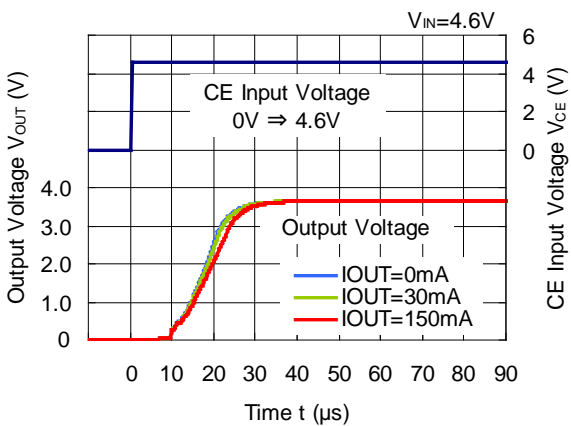

14) Turn off Speed with CE pin (C1 = Ceramic 1.0 μ F, C2 = Ceramic 1.0 μ F, Ta = 25°C)

RP111x071D

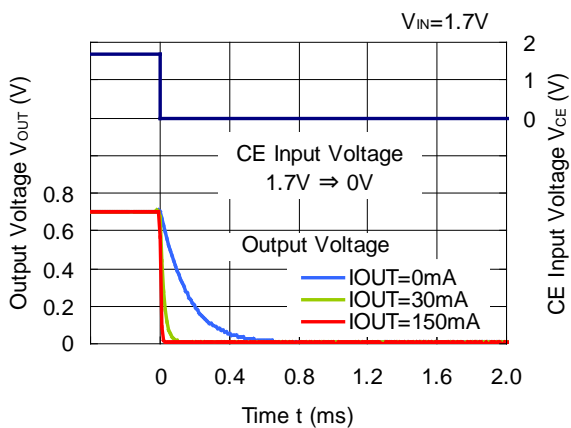

RP111x171D

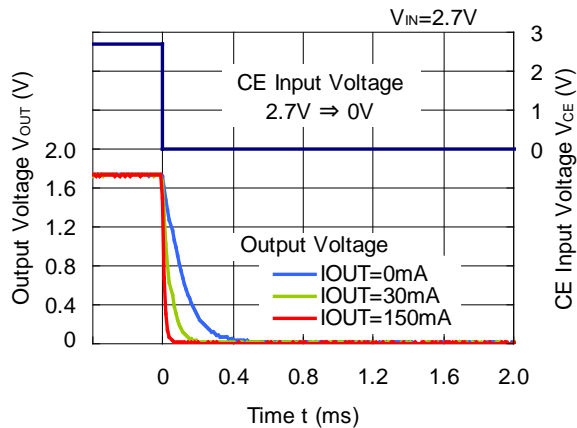

RP111x181D

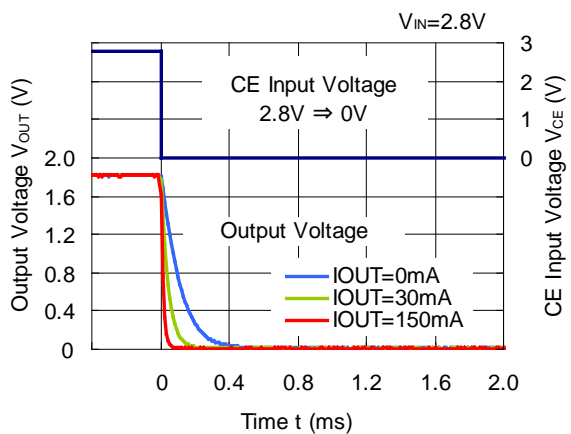

RP111x281D

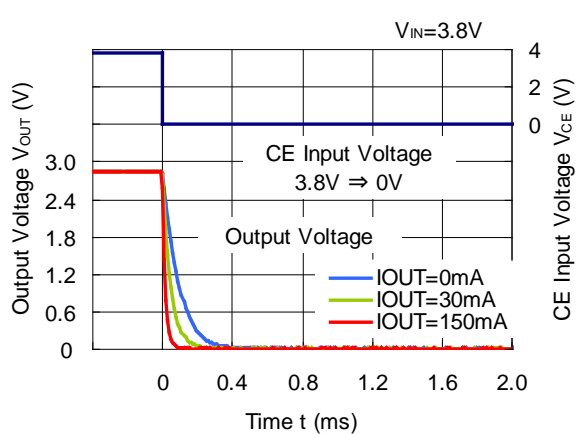

RP111x361D

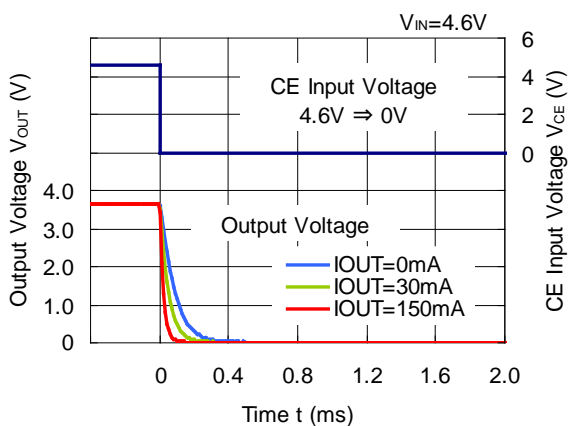

15) Inrush Current (C1 = Ceramic 1.0 μ F, I_{OUT} = 0 mA, Ta = 25°C)

RP111x071x

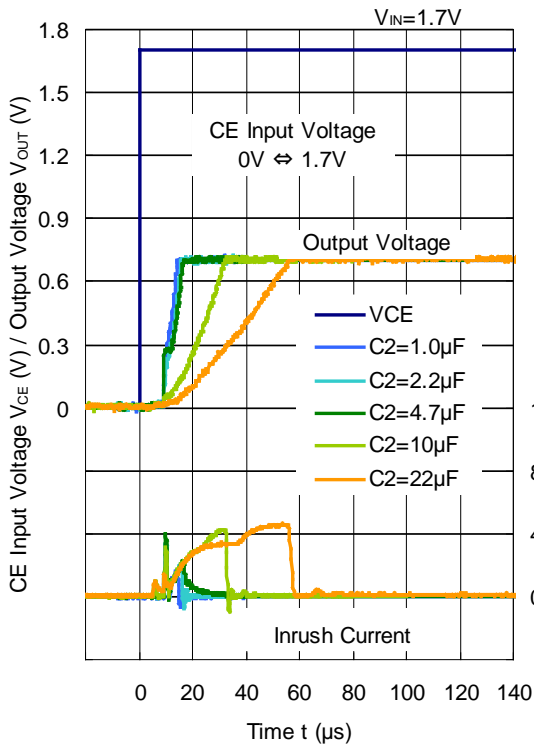

RP111x071x

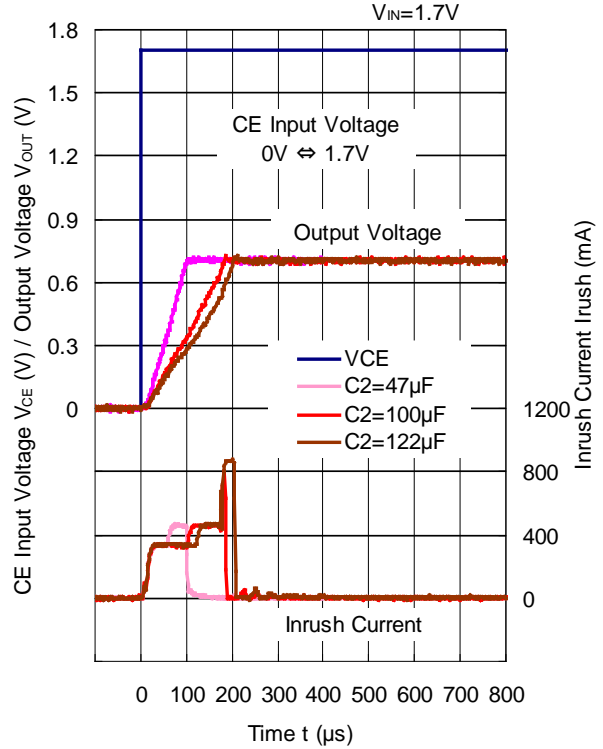

RP111x171x

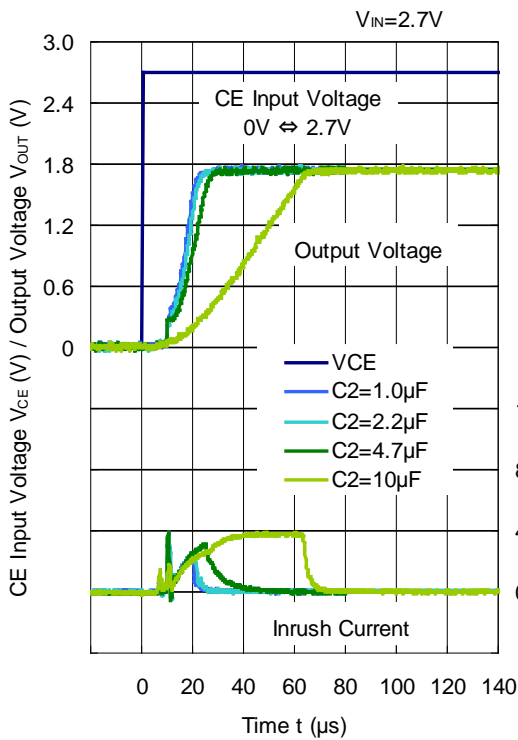

RP111x171x

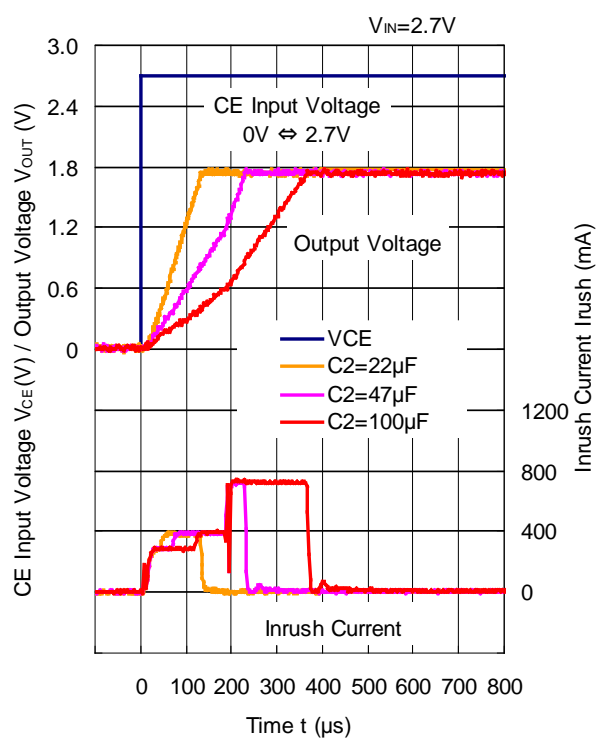

RP111x181x

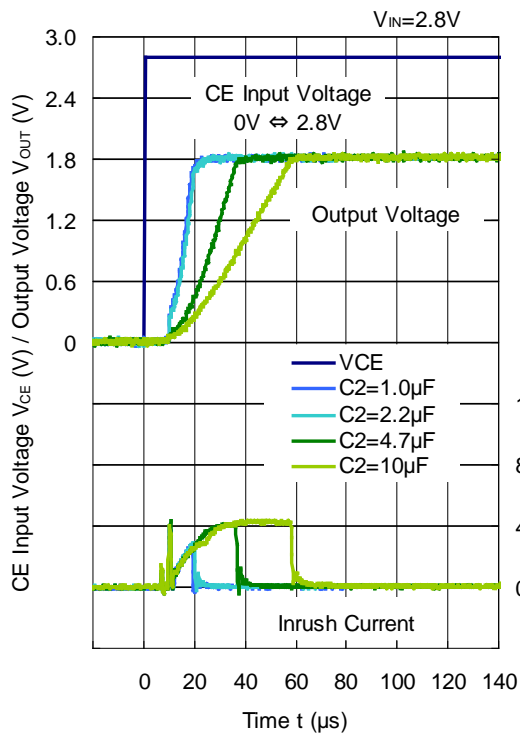

RP111x181x

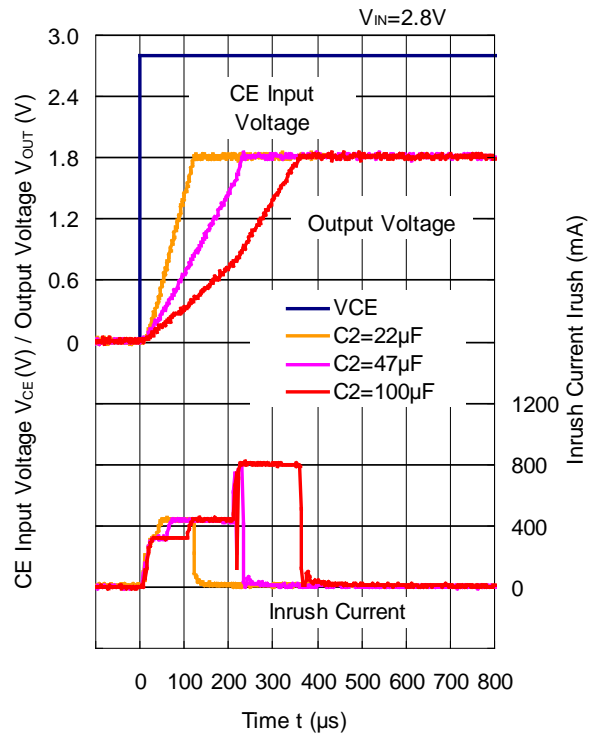

RP111x281x

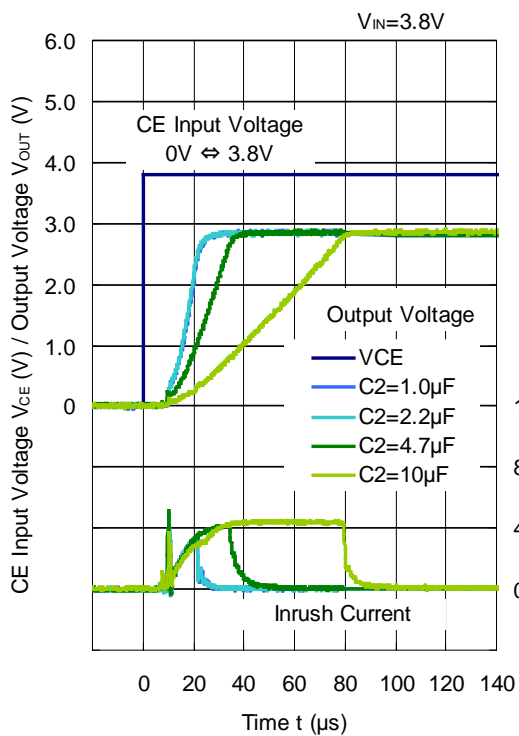

RP111x281x

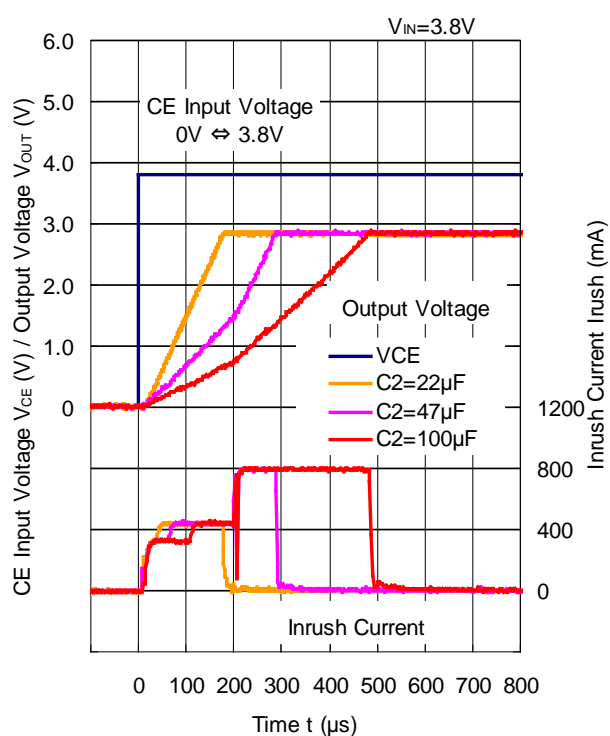

RP111x361x

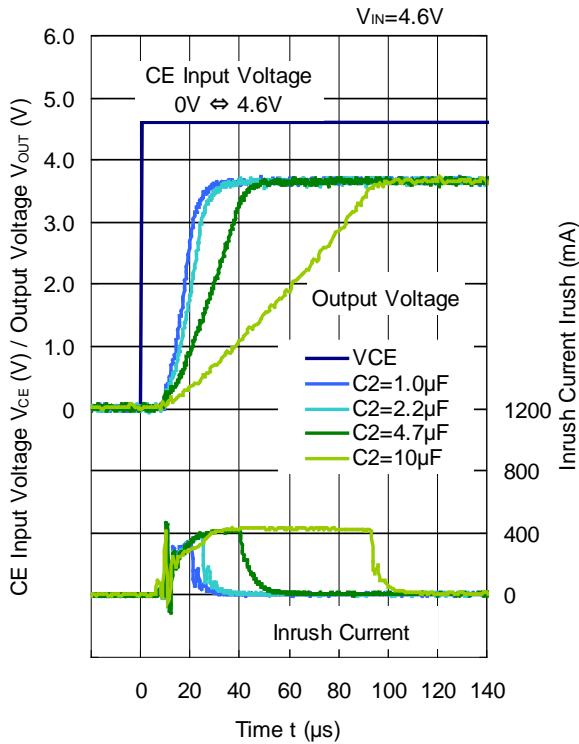

RP111x361x

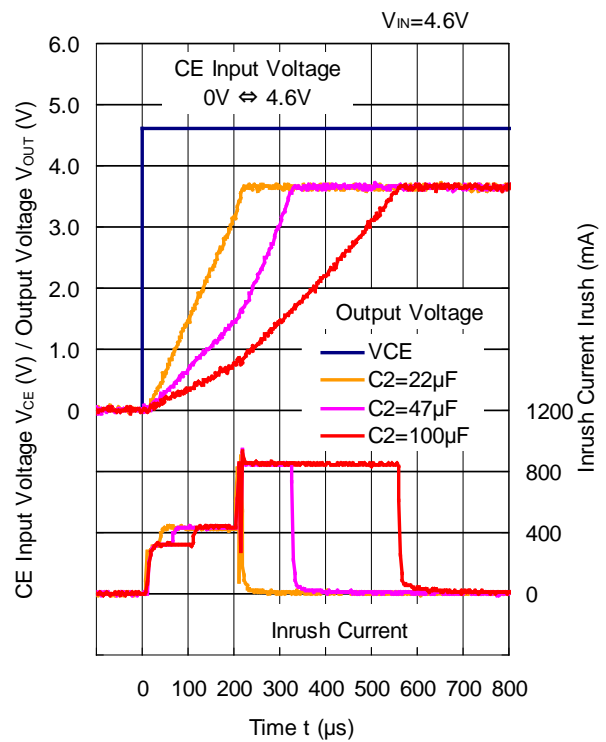

ESR vs. Output Current

When using these ICs, consider the following points: The relations between I_{OUT} (Output Current) and ESR of an output capacitor are shown below. The conditions when the white noise level is under 40 μV (Avg.) are marked as the hatched area in the graph.

Measurement Conditions

- Frequency Band: 10 Hz to 2 MHz
- Temperature : $-40^{\circ}C$ to $85^{\circ}C$
- C1, C2 : 1.0 μF or more

RP111x071x

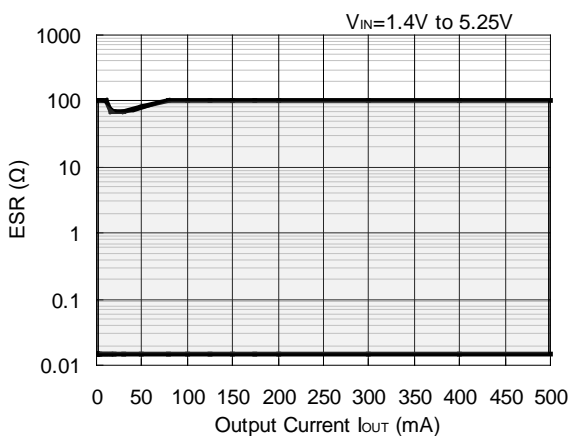

RP111x171x

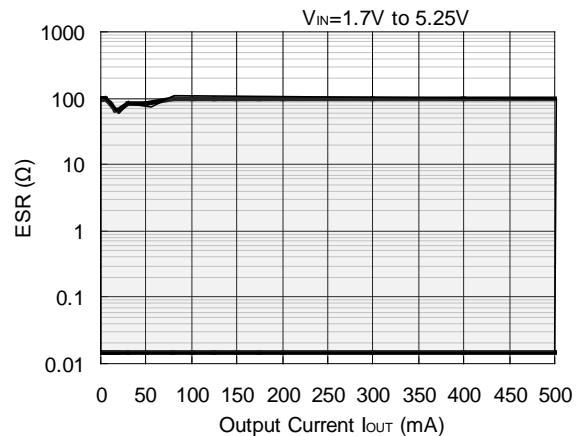

RP111x181x

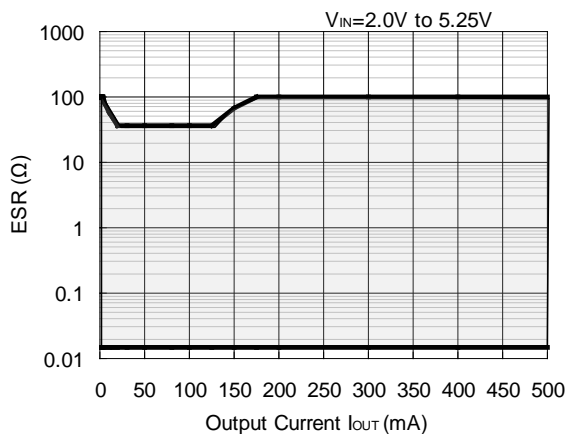

RP111x281x

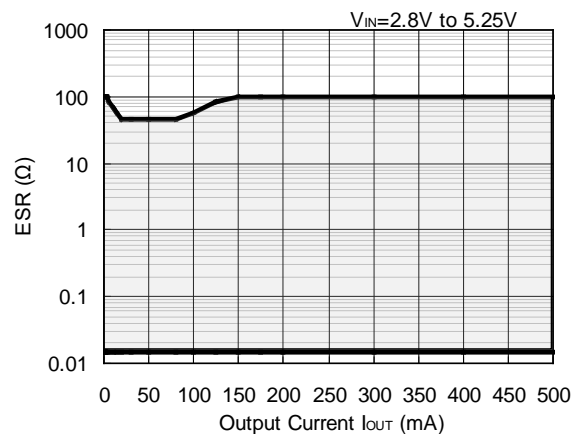

RP111x361x

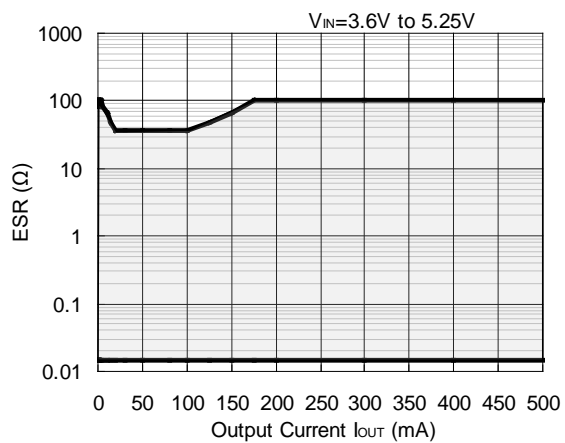



1. The products and the product specifications described in this document are subject to change or discontinuation of production without notice for reasons such as improvement. Therefore, before deciding to use the products, please refer to Ricoh sales representatives for the latest information thereon.
2. The materials in this document may not be copied or otherwise reproduced in whole or in part without prior written consent of Ricoh.
3. Please be sure to take any necessary formalities under relevant laws or regulations before exporting or otherwise taking out of your country the products or the technical information described herein.
4. The technical information described in this document shows typical characteristics of and example application circuits for the products. The release of such information is not to be construed as a warranty of or a grant of license under Ricoh's or any third party's intellectual property rights or any other rights.
5. The products listed in this document are intended and designed for use as general electronic components in standard applications (office equipment, telecommunication equipment, measuring instruments, consumer electronic products, amusement equipment etc.). Those customers intending to use a product in an application requiring extreme quality and reliability, for example, in a highly specific application where the failure or misoperation of the product could result in human injury or death (aircraft, spacevehicle, nuclear reactor control system, traffic control system, automotive and transportation equipment, combustion equipment, safety devices, life support system etc.) should first contact us.
6. We are making our continuous effort to improve the quality and reliability of our products, but semiconductor products are likely to fail with certain probability. In order to prevent any injury to persons or damages to property resulting from such failure, customers should be careful enough to incorporate safety measures in their design, such as redundancy feature, fire containment feature and fail-safe feature. We do not assume any liability or responsibility for any loss or damage arising from misuse or inappropriate use of the products.
7. Anti-radiation design is not implemented in the products described in this document.
8. The X-ray exposure can influence functions and characteristics of the products. Confirm the product functions and characteristics in the evaluation stage.
9. WLCSP products should be used in light shielded environments. The light exposure can influence functions and characteristics of the products under operation or storage.
10. There can be variation in the marking when different AOI (Automated Optical Inspection) equipment is used. In the case of recognizing the marking characteristic with AOI, please contact Ricoh sales or our distributor before attempting to use AOI.
11. Please contact Ricoh sales representatives should you have any questions or comments concerning the products or the technical information.



Ricoh is committed to reducing the environmental loading materials in electrical devices with a view to contributing to the protection of human health and the environment.

Ricoh has been providing RoHS compliant products since April 1, 2006 and Halogen-free products since April 1, 2012.

RICOH RICOH ELECTRONIC DEVICES CO., LTD.

Official website

<https://www.n-redc.co.jp/en/>

Contact us

<https://www.n-redc.co.jp/en/buy/>

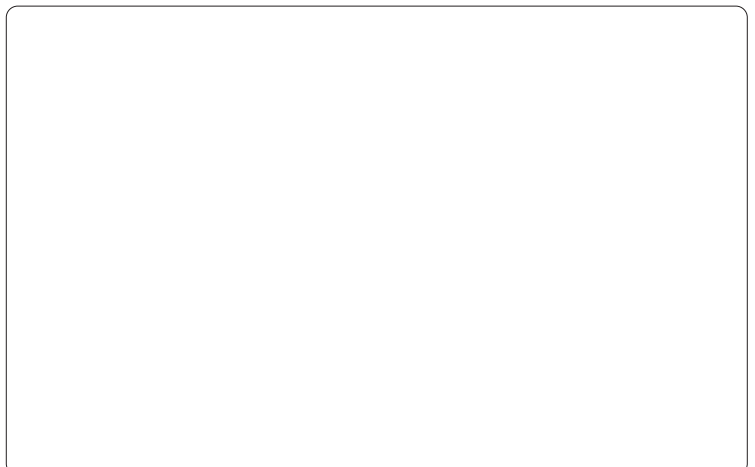

X-ON Electronics

Largest Supplier of Electrical and Electronic Components

Click to view similar products for [LDO Voltage Regulators](#) category:

Click to view products by [Nisshinbo](#) manufacturer:

Other Similar products are found below :

[AP7363-SP-13](#) [L79M05TL-E](#) [PT7M8202B12TA5EX](#) [TCR3DF185,LM\(CT](#) [TCR3DF24,LM\(CT](#) [TCR3DF285,LM\(CT](#) [TCR3DF31,LM\(CT](#)
[TCR3DF45,LM\(CT](#) [MP2013GQ-33-Z](#) [059985X](#) [NCP4687DH15T1G](#) [701326R](#) [TCR2EN28,LF\(S](#) [NCV8170AXV250T2G](#)
[TCR3DF27,LM\(CT](#) [TCR3DF19,LM\(CT](#) [TCR3DF125,LM\(CT](#) [TCR2EN18,LF\(S](#) [AP2112R5A-3.3TRG1](#) [AP7315-25W5-7](#)
[IFX30081LDVGRNXUMA1](#) [NCV47411PAAJR2G](#) [AP2113KTR-G1](#) [AP2111H-1.2TRG1](#) [ZLDO1117QK50TC](#) [AZ1117IH-1.8TRG1](#)
[AZ1117ID-ADJTRG1](#) [TCR3DG12,LF](#) [MIC5514-3.3YMT-T5](#) [MIC5512-1.2YMT-T5](#) [MIC5317-2.8YM5-T5](#) [SCD7912BTG](#)
[NCP154MX180270TAG](#) [SCD33269T-5.0G](#) [NCV8170BMX330TCG](#) [NCV8170AMX120TCG](#) [NCP706ABMX300TAG](#)
[NCP153MX330180TCG](#) [NCP114BMX075TCG](#) [MC33269T-3.5G](#) [CAT6243-ADJCMT5T](#) [TCR3DG33,LF](#) [AP2127N-1.0TRG1](#)
[TCR4DG35,LF](#) [TAR5S15U\(TE85L,F\)](#) [TAR5S18U\(TE85L,F\)](#) [TCR3UG19A,LF](#) [TCR4DG105,LF](#) [NCV8170AMX360TCG](#) [MIC94310-](#)
[NYMT-T5](#)