

Good Transient Response Low Voltage 500mA LDO

NO.EA-241-190523

OUTLINE

The RP111x Series are CMOS-based LDO regulators featuring 500mA output current. The input voltage is as low as 1.4V and the output voltage can be set from 0.7V. Due to a built-in 0.46Ω (at $V_{OUT}=2.8V$) on-resistor, RP111x can provide a low dropout voltage. RP111x also features an excellent line transient response, ripple rejection at 75dB, and low noise. The output voltage accuracy is as high as $\pm 0.8\%$ and the temperature drift coefficient of output voltage is low at $\pm 30\text{ppm}/^\circ\text{C}$. The accuracy of the output voltage of RP111x includes the temperature characteristics and the load transient response has been improved. The typ. and max value of under/overshoot for various output current are shown in the typical characteristics in the datasheet, therefore the accuracy of the output voltage estimation will be easy on the actual operating cases.

In addition to a fold-back protection circuit built into conventional regulators, RP111x contains a thermal shutdown circuit and an inrush current limit circuit. SOT-23-5 and SOT-89-5 packages, a 1.2mm square DFN1212-6 package are available.

FEATURES

- Supply Current Typ. 80μA
- Standby Current Typ. 0.1μA
- Dropout Voltage Typ. 0.23V ($I_{OUT}=500\text{mA}$, $V_{OUT}=2.5V$)
- Ripple Rejection Typ. 75dB ($f=1\text{kHz}$)
Typ. 70dB ($f=10\text{kHz}$)
- Output Voltage Accuracy $\pm 0.8\%$ ($V_{OUT} \geq 1.8V$)
- Output Voltage Temperature Coefficient Typ. $\pm 30\text{ppm}/^\circ\text{C}$ ($V_{OUT} \geq 1.8V$)
- Line Regulation Typ. 0.02%/V
- Packages DFN1212-6, SOT-23-5, SOT-89-5,
- Input Voltage Range 1.4V to 5.25V
- Output Voltage Range 0.7V to 3.6V (0.1V steps)
(For other voltages, please refer to MARK INFORMATION.)
- Built-in Foldback Protection Circuit Typ. 50mA (Current at short mode)
- Thermal Shutdown Temperature 165°C
- Inrush Current Limit Typ. 400mA (for 180μs after start-up)
- Ceramic capacitors are recommended to be used with this IC 1.0μF or more

APPLICATIONS

- Power source for portable communication equipment.
- Power source for electrical appliances such as cameras, VCRs and camcorders.
- Power source for battery-powered equipments.
- Power source for electrical home appliances.

BLOCK DIAGRAMS

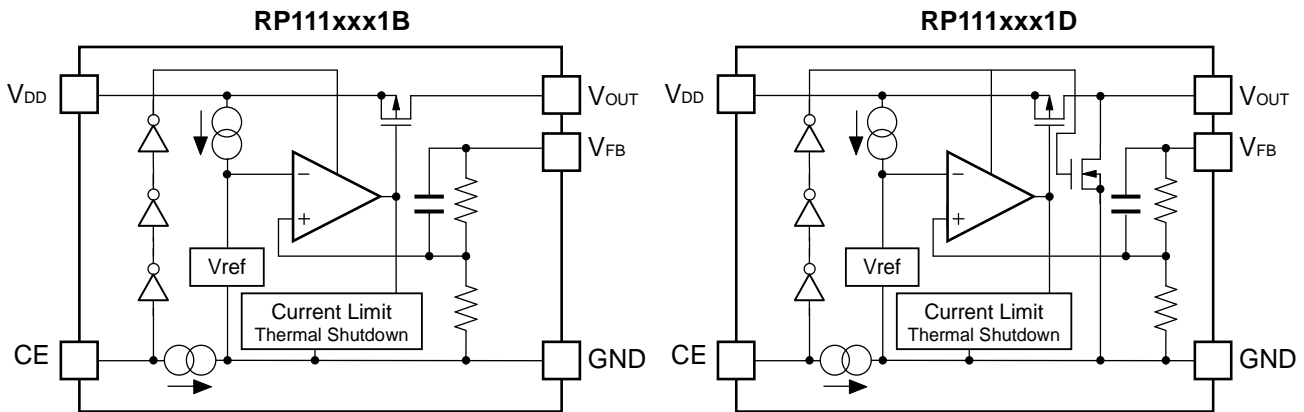

SELECTION GUIDE

The output voltage, auto discharge function, package for the ICs can be selected at the user's request.

Product Name	Package	Quantity per Reel	Pb Free	Halogen Free
RP111Lxx1*-TR	DFN1212-6	5,000 pcs	Yes	Yes
RP111Nxx1*-TR-FE	SOT-23-5	3,000 pcs	Yes	Yes
RP111Hxx1*-T1-FE	SOT-89-5	1,000 pcs	Yes	Yes

xxx: The output voltage can be designated in the range of 0.7V(07) to 3.6V(36) in 0.1V steps.
(For other voltages, please refer to MARK INFORMATIONS.)

* : Auto discharge function at off state are options as follows.
(B) without auto discharge function at off state
(D) with auto discharge function at off state

PIN CONFIGURATIONS

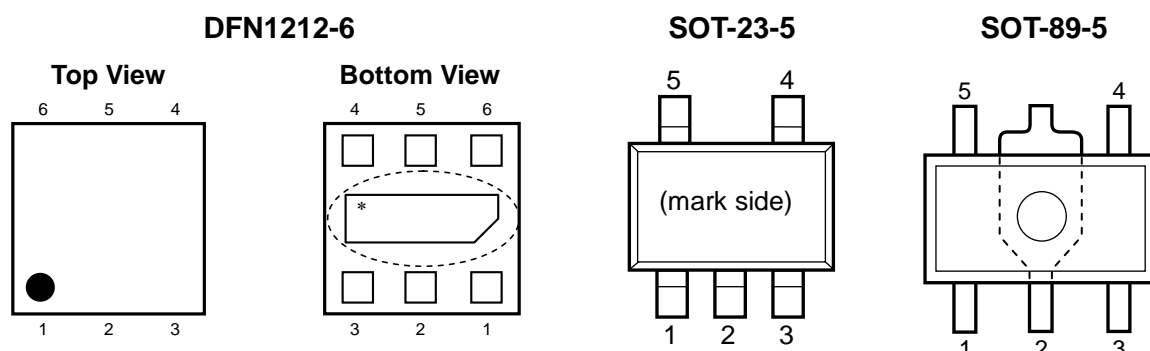

PIN DESCRIPTIONS

• DFN1212-6

Pin No.	Symbol	Description
1	V_{OUT}	Output Pin
2	V_{FB}	Feed Back Pin
3	GND	Ground Pin
4	CE	Chip Enable Pin ("H" Active)
5	NC	No connection
6	V_{DD}	Input Pin

*) Tab is GND level. (They are connected to the reverse side of this IC.)

The tab is better to be connected to the GND, but leaving it open is also acceptable.

• SOT-23-5

Pin No	Symbol	Pin Description
1	V_{DD}	Input Pin
2	GND	Ground Pin
3	CE	Chip Enable Pin ("H" Active)
4	V_{FB}	Feed Back Pin
5	V_{OUT}	Output Pin

• SOT-89-5

Pin No	Symbol	Pin Description
1	V_{FB}	Feed Back Pin
2	GND	Ground Pin
3	CE	Chip Enable Pin ("H" Active)
4	V_{DD}	Input Pin
5	V_{OUT}	Output Pin

Under normal conditions, please connect the V_{OUT} pin to the V_{FB} pin. However, in the case of adjusting the output voltage with the V_{FB} pin, please follow the " ADJUSTABLE OUTPUT VOLTAGE SETTING".

ABSOLUTE MAXIMUM RATINGS

Symbol	Item	Rating	Unit
V _{IN}	Input Voltage	6.0	V
V _{CE}	Input Voltage (CE Pin)	-0.3~6.0	V
V _{OUT}	Output Voltage	-0.3 to V _{IN} +0.3	V
I _{OUT}	Output Current	510	mA
P _D	Power Dissipation (DFN1212-6)*	600	mW
	Power Dissipation (SOT-23-5) *	420	
	Power Dissipation (SOT-89-5) *	900	
T _a	Operating Temperature Range	-40 to 85	°C
T _{stg}	Storage Temperature Range	-55 to 125	°C

*) For Power Dissipation, please refer to PACKAGE INFORMATION.

ABSOLUTE MAXIMUM RATINGS

Electronic and mechanical stress momentarily exceeded absolute maximum ratings may cause permanent damage and may degrade the life time and safety for both device and system using the device in the field. The functional operation at or over these absolute maximum ratings is not assured.

ELECTRICAL CHARACTERISTICS

Unless otherwise noted, $V_{IN} = \text{Set } V_{OUT} + 1.0V (V_{OUT} > 1.5)$, $V_{IN} = 2.5V (V_{OUT} \leq 1.5V)$, $I_{OUT} = 1mA$, $C_{IN} = C_{OUT} = 1.0\mu F$.

The specifications surrounded by are guaranteed by Design Engineering at $-40^{\circ}C \leq T_a \leq 85^{\circ}C$.

● RP111xxx1B/D

$T_a = 25^{\circ}C$

Symbol	Item	Conditions	Min.	Typ.	Max.	Unit	
V_{OUT}	Output Voltage	$T_a = 25^{\circ}C$	$V_{OUT} \geq 1.8V$	$\times 0.992$		$\times 1.008$	V
			$V_{OUT} < 1.8V$	-18		+18	mV
		$-40^{\circ}C \leq T_a \leq 85^{\circ}C$	$V_{OUT} \geq 1.8V$	$\times 0.985$		$\times 1.015$	V
			$V_{OUT} < 1.8V$	-55		50	mV
I_{OUT}	Output Current		500			mA	
$\Delta V_{OUT}/\Delta I_{OUT}$	Load Regulation	$1mA \leq I_{OUT} \leq 500mA$		1	20	mV	
V_{TRLD}	Load Transient Response	$I_{OUT} : 1mA \Leftrightarrow 250mA$ ($tr = tf = 0.5\mu s$)	$C_{OUT} = 1\mu F$		-75 +45	mV	
			$C_{OUT} = 2.2\mu F$		-55 +35		
		$I_{OUT} : 1mA \Leftrightarrow 250mA$ ($tr = tf = 5.0\mu s$)	$C_{OUT} = 1\mu F$		-20 +15		
V_{DIF}	Dropout Voltage	Please refer to "Dropout Voltage".					
I_{SS}	Supply Current	$I_{OUT} = 0mA$		80	125	μA	
$I_{standby}$	Standby Current	$V_{CE} = 0V$		0.1	1.0	μA	
$\Delta V_{OUT}/\Delta V_{IN}$	Line Regulation	Set $V_{OUT} + 0.5V \leq V_{IN} \leq 5.25V$, $V_{IN} \geq 1.4V$		0.02	0.10	%/V	
V_{TRLN}	Input Transient Response	$V_{IN} : \text{Set } V_{OUT} + 0.5V \Leftrightarrow$ Set $V_{OUT} + 1.5V (tr = tf = 5.0\mu s)$, $V_{IN} \geq 1.4V, I_{OUT} = 30mA$		-1.5 +1.5		mV	
RR	Ripple Rejection	$f = 1kHz$, Ripple $0.2Vp-p$, $V_{IN} = \text{Set } V_{OUT} + 1.0V, I_{OUT} = 30mA$ ($V_{OUT} \leq 2.0V, V_{IN} = 3.0V$)		75		dB	
V_{IN}	Input Voltage*		1.4		5.25	V	
$\Delta V_{OUT}/\Delta T_a$	Output Voltage Temperature Coefficient	$40^{\circ}C \leq T_a \leq 85^{\circ}C$	$V_{OUT} \geq 1.8V$		± 30	ppm/ $^{\circ}C$	
			$V_{OUT} < 1.8V$		± 100		
I_{SC}	Short Current Limit	$V_{OUT} = 0V$		50		mA	
I_{PD}	CE Pull-down Current			0.3	0.6	μA	
V_{CEH}	CE Input Voltage "H"		1.0			V	
V_{CEL}	CE Input Voltage "L"				0.4	V	
T_{TSD}	Thermal Shutdown Temperature	Junction Temperature			165	$^{\circ}C$	
T_{TSR}	Thermal Shutdown Released Temperature	Junction Temperature			100		
en	Output Noise	BW = 10Hz ~ 100kHz	$V_{OUT} \geq 1.8V$		$20 \times V_{OUT}$	μV_{rms}	
			$V_{OUT} < 1.8V$		$40 \times V_{OUT}$		

RP111x

NO.EA-241-190523

ELECTRICAL CHARACTERISTICS

Unless otherwise noted, $V_{IN} = \text{Set } V_{OUT} + 1.0V (V_{OUT} > 1.5)$, $V_{IN} = 2.5V (V_{OUT} \leq 1.5V)$, $I_{OUT} = 1\text{mA}$, $C_{IN} = C_{OUT} = 1.0\mu\text{F}$.

The specifications surrounded by are guaranteed by Design Engineering at $-40^\circ\text{C} \leq T_a \leq 85^\circ\text{C}$.

● RP111xxx1B/D

$T_a = 25^\circ\text{C}$

Symbol	Item	Conditions	Min.	Typ.	Max.	Unit
R_{LOW}	Low Output Nch Tr. ON Resistance (of D version)	$V_{IN} = 4.0V$, $V_{CE} = 0V$		60		Ω

All of units are tested and specified under load conditions such that $T_j = T_a = 25^\circ\text{C}$ except for Output Voltage Temperature Coefficient, Load Transient Response, Input Transient Response, Output Noise and Ripple Rejection.

*) When Input Voltage is 5.5V, the total operational time must be within 500hrs.

● Dropout Voltage

$T_a = 25^\circ\text{C}$

Output Voltage V_{OUT} (V)	Dropout Voltage V_{DIF} (V)		
	Condition	Typ.	Max.
$0.7 \leq V_{OUT} < 0.8$	$I_{OUT} = 500\text{mA}$	0.58	<input type="checkbox"/> 0.88
$0.8 \leq V_{OUT} < 0.9$		0.52	<input type="checkbox"/> 0.80
$0.9 \leq V_{OUT} < 1.0$		0.45	<input type="checkbox"/> 0.70
$1.0 \leq V_{OUT} < 1.2$		0.42	<input type="checkbox"/> 0.64
$1.2 \leq V_{OUT} < 1.4$		0.35	<input type="checkbox"/> 0.53
$1.4 \leq V_{OUT} < 1.8$		0.31	<input type="checkbox"/> 0.48
$1.8 \leq V_{OUT} < 2.1$		0.27	<input type="checkbox"/> 0.41
$2.1 \leq V_{OUT} < 2.5$		0.25	<input type="checkbox"/> 0.38
$2.5 \leq V_{OUT} < 3.0$		0.23	<input type="checkbox"/> 0.34
$3.0 \leq V_{OUT} \leq 3.6$		0.22	<input type="checkbox"/> 0.32

RECOMMENDED OPERATING CONDITIONS (ELECTRICAL CHARACTERISTICS)

All of electronic equipment should be designed that the mounted semiconductor devices operate within the recommended operating conditions. The semiconductor devices cannot operate normally over the recommended operating conditions, even if they are used over such conditions by momentary electronic noise or surge. And the semiconductor devices may receive serious damage when they continue to operate over the recommended operating conditions.

TYPICAL APPLICATIONS

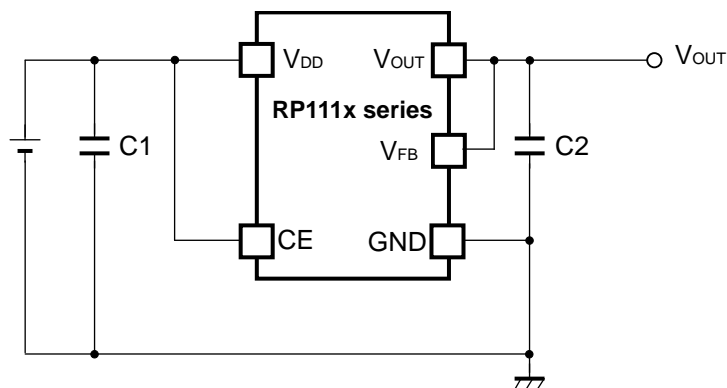

External Parts Example:

C1, C2: Ceramic Capacitor 1.0 μ F, Murata, GRM155B31A105KE15

Under normal conditions, please connect the V_{OUT} pin to the V_{FB} pin. However, in the case of adjusting the output voltage with the V_{FB} pin, please follow the "ADJUSTABLE OUTPUT VOLTAGE SETTING".

TECHNICAL NOTES

Phase Compensation

In these ICs, phase compensation is made for securing stable operation even if the load current is varied. For this purpose, use a 1.0 μ F or more capacitor C2.

In case of using a tantalum capacitor, the output may be unstable due to inappropriate ESR. Therefore, the full range of operating conditions for the capacitor in the application should be considered.

PCB Layout

Make V_{DD} and GND lines sufficient. If their impedance is high, noise pickup or unstable operation may result. Connect a capacitor C1 with a capacitance value as much as 1.0 μ F or more between V_{DD} and GND pin, and as close as possible to the pins.

Set external components, especially the output capacitor C2, as close as possible to the ICs, and make wiring as short as possible.

ADJUSTABLE OUTPUT VOLTAGE SETTING

Output Voltage Setting

RP111x is capable of adjusting the output voltage by using the external divider resistors. If the V_{FB} voltage fixed in the device is described as $setV_{FB}$, the output voltage can be set by using the following formulas.

$$I1 = I_{IC} + I2 \dots\dots\dots (1)$$

$$I2 = setV_{FB} / R2 \dots\dots\dots (2)$$

Thus,

$$I1 = I_{IC} + setV_{FB} / R2 \dots\dots\dots (3)$$

Therefore,

$$V_{OUT} = setV_{FB} + R1 \times I1 \dots\dots\dots (4)$$

Put formula (3) into formula (4), then

$$\begin{aligned} V_{OUT} &= setV_{FB} + R1 \times (I_{IC} + setV_{FB} / R2) \\ &= setV_{FB} \times (1 + R1/R2) + R1 \times I_{IC} \dots\dots\dots (5) \end{aligned}$$

In formula (5), $R1 \times I_{IC}$ is the error-causing factor in V_{OUT} .

As for I_{IC} ,

$$I_{IC} = setV_{FB} / R_{IC} \dots\dots\dots (6)$$

Therefore, the error-causing factor $R1 \times I_{IC}$ can be described as follows.

$$\begin{aligned} R1 \times I_{IC} &= R1 \times setV_{FB} / R_{IC} \\ &= setV_{FB} \times R1 / R_{IC} \dots\dots\dots (7) \end{aligned}$$

For better accuracy, choosing $R1 \ll R_{IC}$ reduces this error.

Without the error-causing factor $R1 \times I_{IC}$, the output voltage can be calculated by the following formula.

$$V_{OUT} = setV_{FB} \times ((R1 + R2) / R2) \dots\dots\dots (8)$$

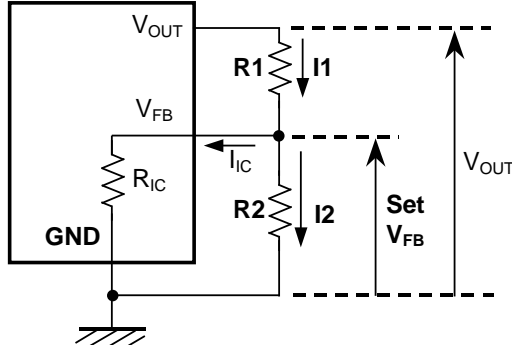

The output voltage of the externally adjustable output voltage type should be set to 3.6 V or less. The resistance of R2 should be 16 kΩ or less.

The graph below shows the relation between the V_{FB} pin voltage ($setV_{FB}$) and the internal resistance of the V_{FB} pin (R_{IC}). For example, R_{IC} will be 200 kΩ typically if $setV_{FB}$ is 0.7 V.

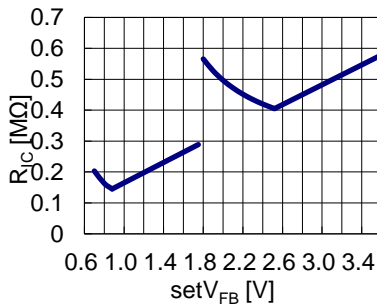

V_{FB} Pin Voltage ($setV_{FB}$) vs. Internal Resistance (R_{IC})

Typical Applications for Adjustable Output Voltage Setting

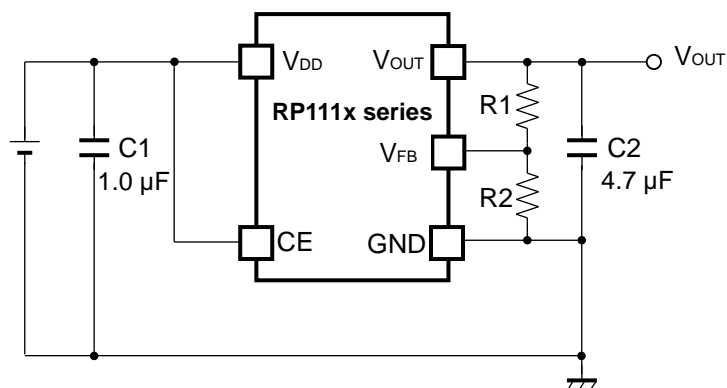

Phase Compensation

Similar to the Fixed Output Voltage Type, Phase compensation is made for the Adjustable Output Voltage Type for securing stable operation even if the load current is varied. For this purpose, use a 4.7μF or more capacitor C2 between V_{OUT} pin and GND pin, and as close as possible to the pins.

PCB Layout

Make V_{DD} and GND lines sufficient. If their impedance is high, noise pickup or unstable operation may result. Connect a capacitor C1 with a capacitance value as much as 1.0μF or more between V_{DD} and GND pin, and as close as possible to the pins.

Transient Response

When using the Adjustable Output Voltage Type, the transient response could be affected by the external resistors. Evaluate the circuit taking the actual conditions of use into account.

TRANSIENT RESPONSE

The RP111x Series have been improved in overall output voltage characteristics including temperature and transient response. The load transient response indicated under the Electrical Characteristics is guaranteed by design based on the condition when I_{OUT} changes from 1mA to 250mA or 250mA to 1mA. The output voltage variations under the other load conditions, the characteristic examples are shown below.

RP111x151x

$V_{IN}=2.5V, -40^{\circ}C \leq T_a \leq 85^{\circ}C$

$C_{IN}=1.0\mu F, C_{OUT}=1.0\mu F, I_{OUT}=1mA \leftrightarrow$ Peak Output Current ($t_r=t_f=0.5\mu s$)

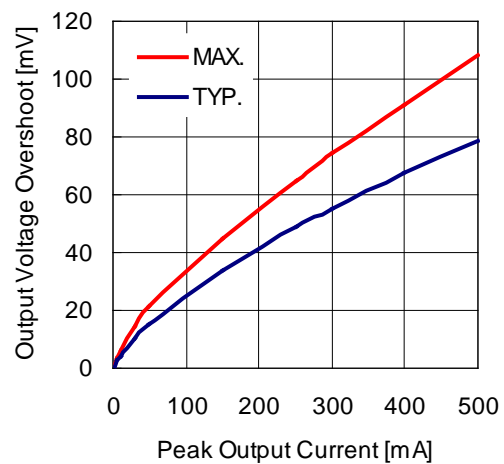
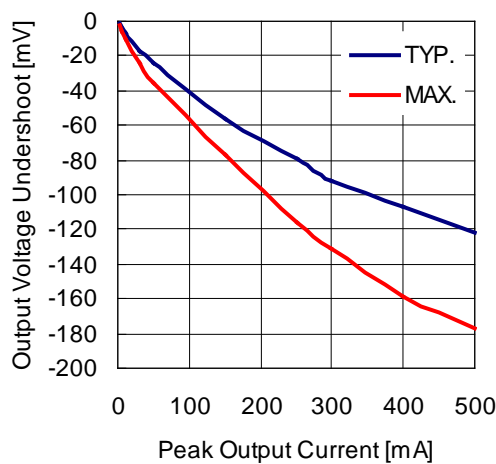

$C_{IN}=1.0\mu F, C_{OUT}=2.2\mu F, I_{OUT}=1mA \leftrightarrow$ Peak Output Current ($t_r=t_f=0.5\mu s$)

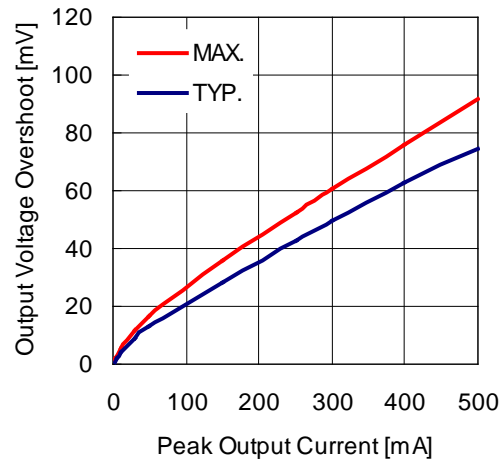
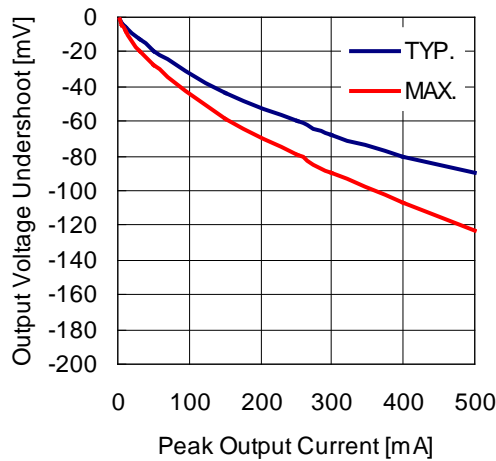

$C_{IN}=1.0\mu F$, $C_{OUT}=1.0\mu F$, $I_{OUT}=1mA \Leftrightarrow$ Peak Output Current ($t_r=t_f=5.0\mu s$)

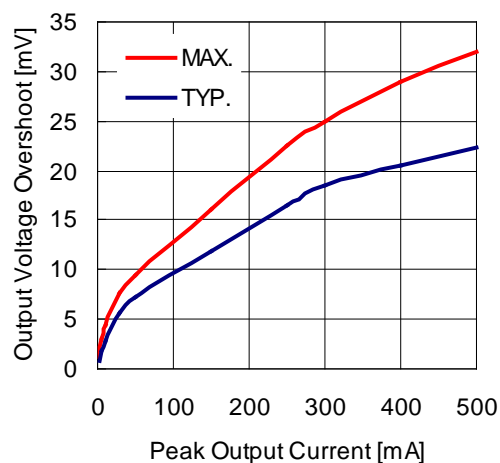
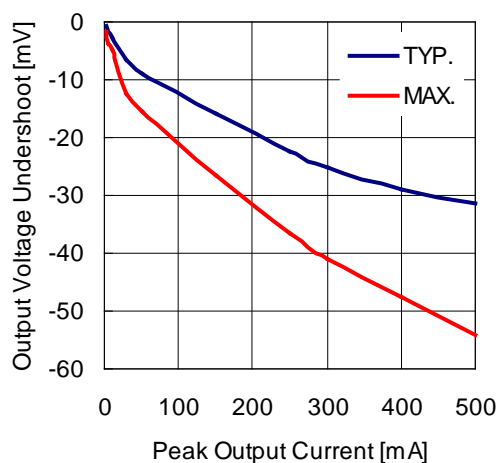

RP111x281x

$V_{IN}=3.8V$, $-40^{\circ}C \leq T_a \leq 85^{\circ}C$

$C_{IN}=1.0\mu F$, $C_{OUT}=1.0\mu F$, $I_{OUT}=1mA \Leftrightarrow$ Peak Output Current ($t_r=t_f=0.5\mu s$)

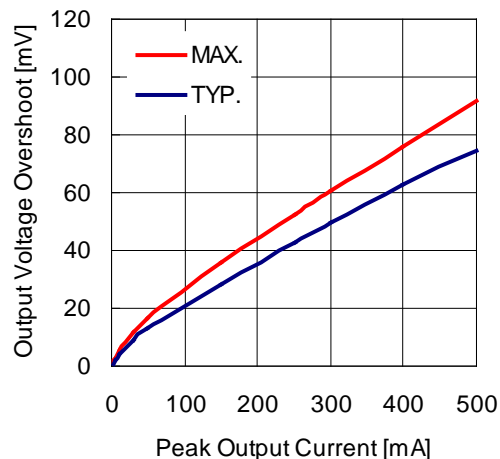
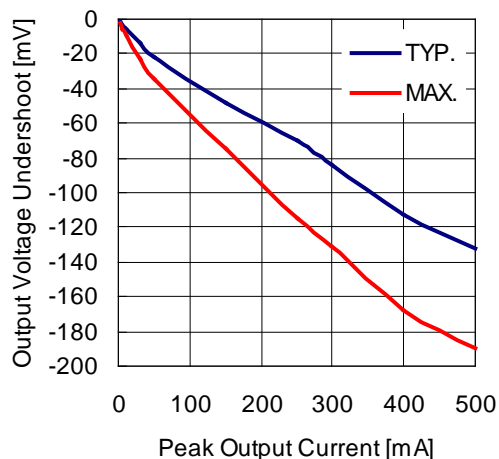

$C_{IN}=1.0\mu F$, $C_{OUT}=2.2\mu F$, $I_{OUT}=1mA \Leftrightarrow$ Peak Output Current ($t_r=t_f=0.5\mu s$)

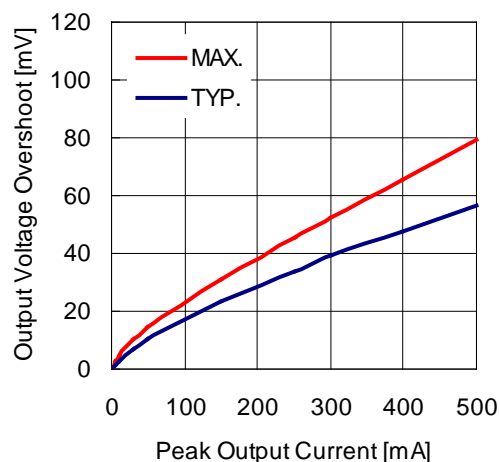
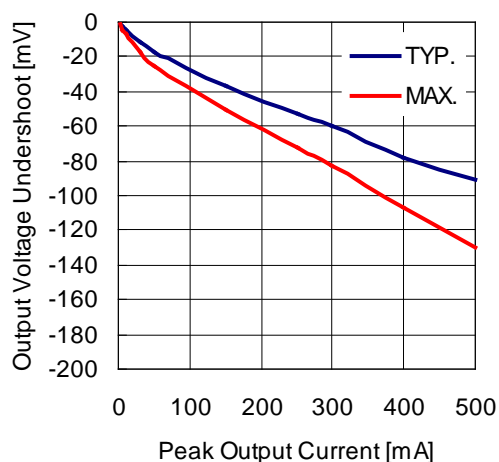

$C_{IN}=1.0\mu F$, $C_{OUT}=1.0\mu F$, $I_{OUT}=1mA \Leftrightarrow$ Peak Output Current ($t_r=t_f=5.0\mu s$)

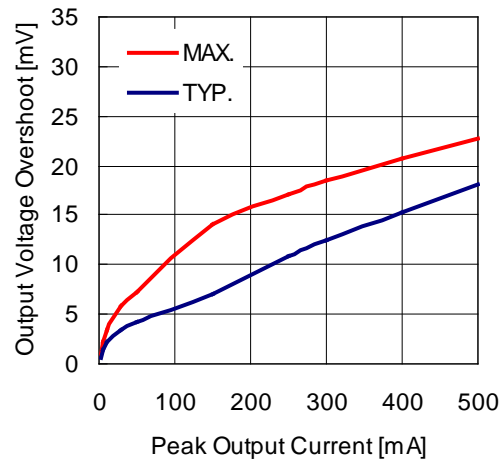
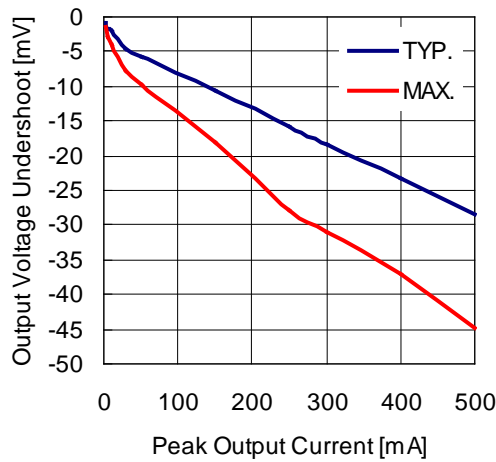

Input Transient Response has the output voltage dependency. Please refer to the characteristics examples below.

V_{IN} : Set $V_{OUT}+0.5V \Leftrightarrow$ Set $V_{OUT}+1.5V$ ($t_r=t_f=5.0\mu s$), $V_{IN} \geq 1.4V$,
 $C_{OUT}=1.0\mu F$, $I_{OUT}=30mA$

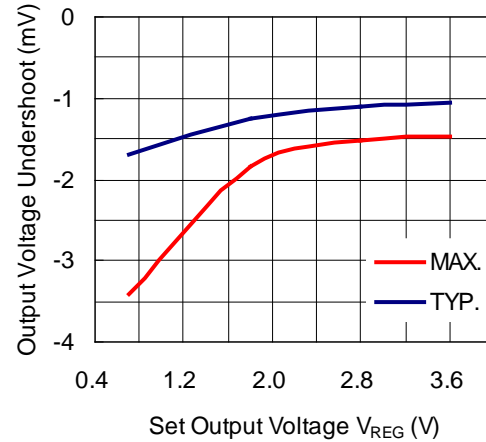
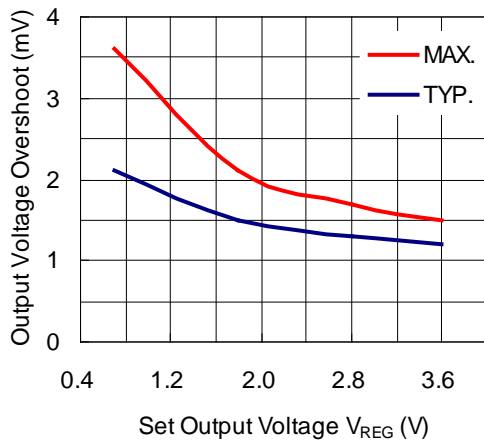

The graphs shown above are reference data.

For the better transient response, a capacitor with higher capacitance is recommended and the wire impedance of GND and V_{OUT} should be minimized as possible.

The transient response characteristics depend on the external parts and PCB layout. Therefore, the operating conditions for the transient response in the application should be considered and evaluation is necessary.

Package Information

• Power Dissipation (DFN1212-6)

Power Dissipation (P_D) depends on conditions of mounting on board. This specification is based on the measurement at the condition below:

Measurement Conditions

	Standard Test Land Pattern
Environment	Mounting on Board (Wind velocity=0m/s)
Board Material	Glass cloth epoxy plastic (Double-sided)
Board Dimensions	40mm x 40mm x 1.6mm
Copper Ratio	Top side: Approx. 50%, Back side: Approx. 50%
Through-holes	ϕ 0.5mm x 28pcs

Measurement Result

($T_a=25^\circ\text{C}$, $T_{j\text{max}}=125^\circ\text{C}$)

	Standard Test Land Pattern
Power Dissipation	600mW ($T_{j\text{max}}=125^\circ\text{C}$) 750mW ($T_{j\text{max}}=150^\circ\text{C}$)
Thermal Resistance	$\theta_{ja}=(125-25^\circ\text{C})/0.6\text{W}=167^\circ\text{C/W}$ $\theta_{jc}=30^\circ\text{C/W}$

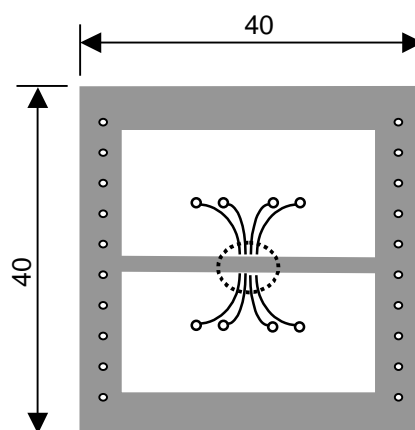
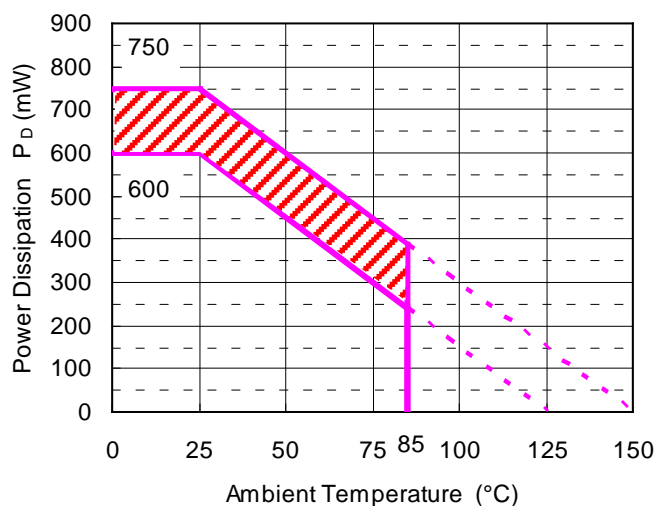

Measurement Board Pattern

IC Mount Area (Unit: mm)

Note: The above graph shows the power dissipation of the package based on $T_{j\text{max}}=125^\circ\text{C}$ and $T_{j\text{max}}=150^\circ\text{C}$. Operating the IC within the shaded area in the graph might have an influence on its lifetime. Operating time must be within the time limit described in the table below.

Operating Time	Estimated Years (Operating 4 hrs/ day)
13,000 hours	9 Years

• Package Dimensions (DFN1212-6)

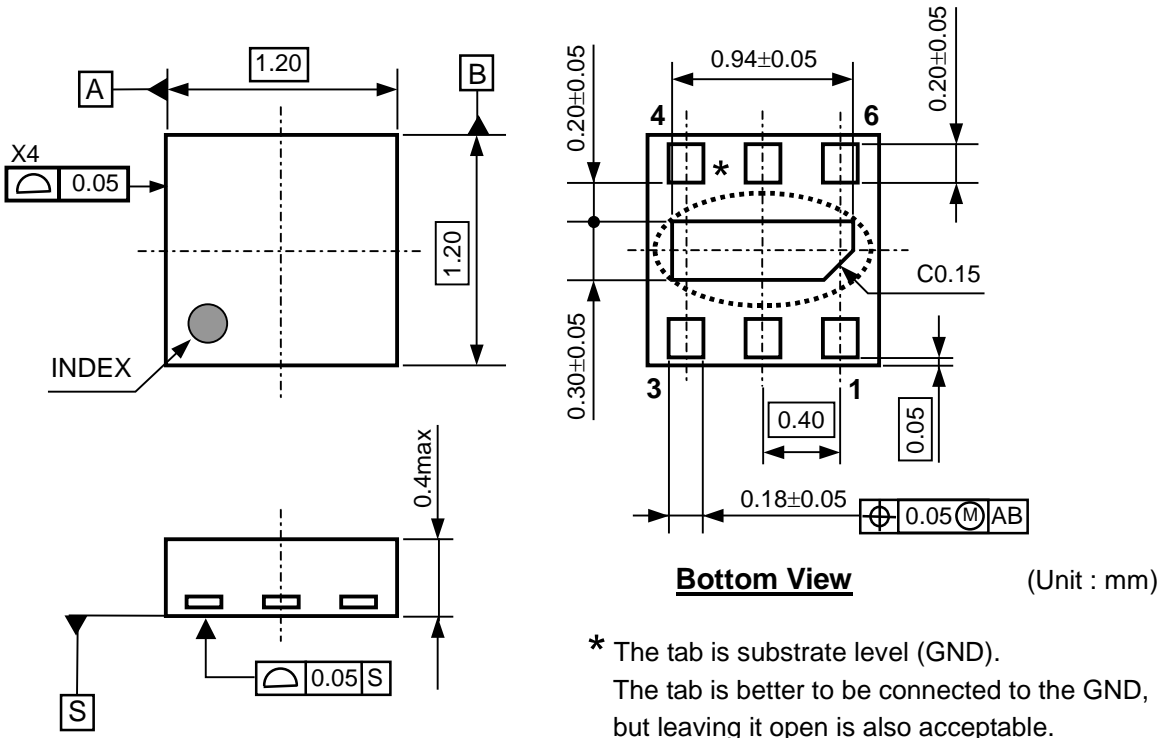

• Mark Specification (DFN1212-6)

- ①②: Product Code ... Refer to "RP111L Series Mark Specification Table (DFN1212-6)".
- ③④: Lot Number ... Alphanumeric Serial Number

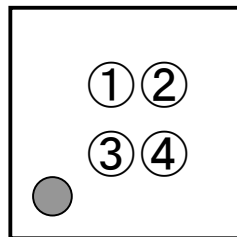

● RP111L Series Mark Specification Table (DFN1212-6)

RP111Lxx1B

Product Name	①②	Vset
RP111L071B	7A	0.7V
RP111L071B5	7B	0.75V
RP111L081B	7C	0.8V
RP111L091B	7D	0.9V
RP111L101B	7E	1.0V
RP111L111B	7F	1.1V
RP111L121B	7G	1.2V
RP111L121B5	7H	1.25V
RP111L131B	7J	1.3V
RP111L141B	7K	1.4V
RP111L151B	7L	1.5V
RP111L161B	7M	1.6V
RP111L171B	7N	1.7V
RP111L181B	7P	1.8V
RP111L181B5	7Q	1.85V
RP111L191B	7R	1.9V
RP111L201B	7S	2.0V
RP111L211B	7T	2.1V
RP111L221B	7U	2.2V
RP111L231B	7V	2.3V
RP111L241B	7W	2.4V
RP111L251B	7X	2.5V
RP111L261B	7Y	2.6V
RP111L271B	7Z	2.7V
RP111L281B	8A	2.8V
RP111L281B5	8B	2.85V
RP111L291B	8C	2.9V
RP111L301B	8D	3.0V
RP111L311B	8E	3.1V
RP111L321B	8F	3.2V
RP111L331B	8G	3.3V
RP111L341B	8H	3.4V
RP111L351B	8J	3.5V
RP111L361B	8K	3.6V
RP111L101B5	8L	1.05V

RP111Lxx1D

Product Name	①②	Vset
RP111L071D	9A	0.7V
RP111L071D5	9B	0.75V
RP111L081D	9C	0.8V
RP111L091D	9D	0.9V
RP111L101D	9E	1.0V
RP111L111D	9F	1.1V
RP111L121D	9G	1.2V
RP111L121D5	9H	1.25V
RP111L131D	9J	1.3V
RP111L141D	9K	1.4V
RP111L151D	9L	1.5V
RP111L161D	9M	1.6V
RP111L171D	9N	1.7V
RP111L181D	9P	1.8V
RP111L181D5	9Q	1.85V
RP111L191D	9R	1.9V
RP111L201D	9S	2.0V
RP111L211D	9T	2.1V
RP111L221D	9U	2.2V
RP111L231D	9V	2.3V
RP111L241D	9W	2.4V
RP111L251D	9X	2.5V
RP111L261D	9Y	2.6V
RP111L271D	9Z	2.7V
RP111L281D	0A	2.8V
RP111L281D5	0B	2.85V
RP111L291D	0C	2.9V
RP111L301D	0D	3.0V
RP111L311D	0E	3.1V
RP111L321D	0F	3.2V
RP111L331D	0G	3.3V
RP111L341D	0H	3.4V
RP111L351D	0J	3.5V
RP111L361D	0K	3.6V
RP111L101D5	0L	1.05V

• **Power Dissipation (SOT-23-5)**

Power Dissipation (P_D) depends on conditions of mounting on board. This specification is based on the measurement at the condition below:

(Power Dissipation (SOT-23-5) is substitution of SOT-23-6.)

Measurement Conditions

Standard Test Land Pattern	
Environment	Mounting on Board (Wind velocity=0m/s)
Board Material	Glass cloth epoxy plastic (Double-sided)
Board Dimensions	40mm x 40mm x 1.6mm
Copper Ratio	Top side: Approx. 50%, Back side: Approx. 50%
Through-holes	ϕ 0.5mm x 44pcs

Measurement Result

($T_a=25^\circ\text{C}$)

	Standard Land Pattern	Free Air
Power Dissipation	420mW ($T_{jmax}=125^\circ\text{C}$) 525mW ($T_{jmax}=150^\circ\text{C}$)	250mW ($T_{jmax}=125^\circ\text{C}$)
Thermal Resistance	$\theta_{ja}=(125-25^\circ\text{C})/0.42\text{W}=238^\circ\text{C/W}$	400 $^\circ\text{C/W}$

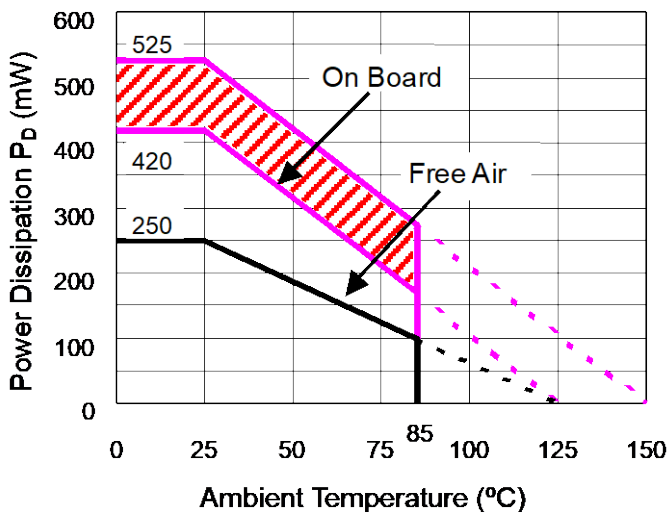

Power Dissipation

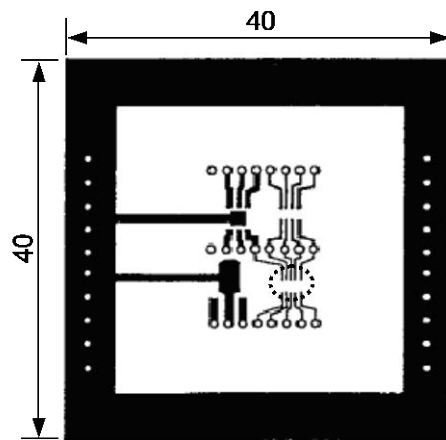

Measurement Board Pattern

IC Mount Area (Unit: mm)

Note: The above graph shows the power dissipation of the package based on $T_{jmax}=125^\circ\text{C}$ and $T_{jmax}=150^\circ\text{C}$. Operating the IC within the shaded area in the graph might have an influence on its lifetime. Operating time must be within the time limit described in the table below.

Operating Time	Estimated Years (Operating 4 hrs/ day)
13,000 hours	9 Years

• Package Dimensions (SOT-23-5)

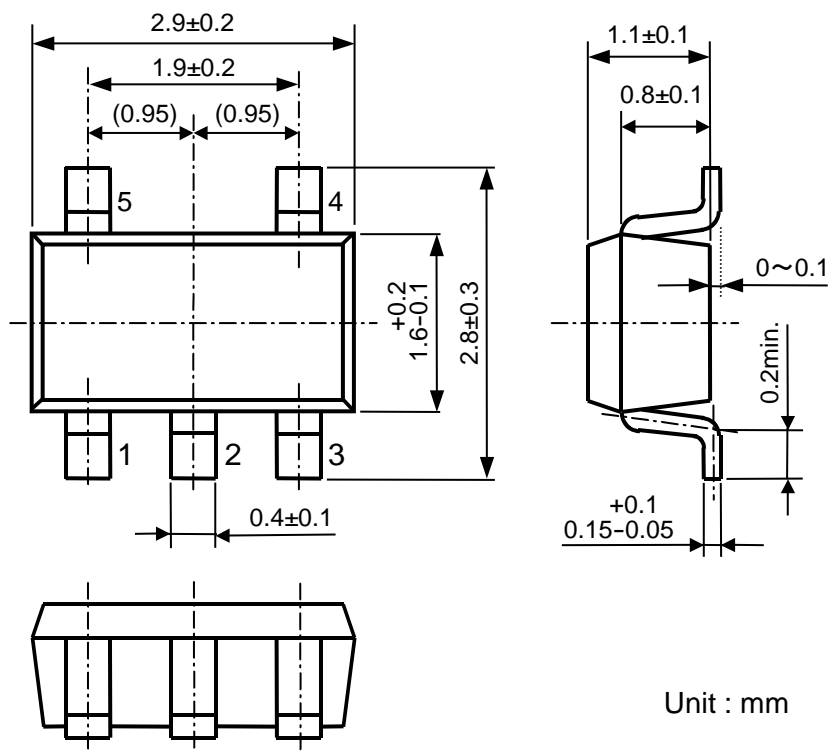

• Mark Specification (SOT-23-5)

- ①②③: Product Code ... Refer to "RP111N Series Mark Specification Table".
- ④⑤ : Lot Number ... Alphanumeric Serial Number.

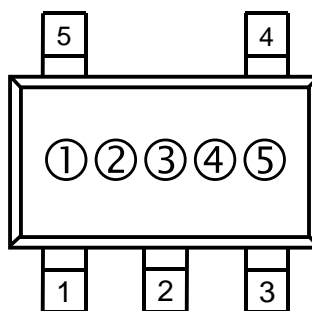

RP111xNO.EA-241-190523

● **RP111N Series Mark Specification Table (SOT-23-5)****RP111Nxx1B**

Product Name	①②③	Vset
RP111N071B	H07	0.7V
RP111N081B	H08	0.8V
RP111N091B	H09	0.9V
RP111N101B	H10	1.0V
RP111N111B	H11	1.1V
RP111N121B	H12	1.2V
RP111N131B	H13	1.3V
RP111N141B	H14	1.4V
RP111N151B	H15	1.5V
RP111N161B	H16	1.6V
RP111N171B	H17	1.7V
RP111N181B	H18	1.8V
RP111N191B	H19	1.9V
RP111N201B	H20	2.0V
RP111N211B	H21	2.1V
RP111N221B	H22	2.2V
RP111N231B	H23	2.3V
RP111N241B	H24	2.4V
RP111N251B	H25	2.5V
RP111N261B	H26	2.6V
RP111N271B	H27	2.7V
RP111N281B	H28	2.8V
RP111N291B	H29	2.9V
RP111N301B	H30	3.0V
RP111N311B	H31	3.1V
RP111N321B	H32	3.2V
RP111N331B	H33	3.3V
RP111N341B	H34	3.4V
RP111N351B	H35	3.5V
RP111N361B	H36	3.6V
RP111N071B5	H37	0.75V
RP111N121B5	H38	1.25V
RP111N181B5	H39	1.85V
RP111N281B5	H40	2.85V
RP111N101B5	H41	1.05V

RP111Nxx1D

Product Name	①②③	Vset
RP111N071D	J07	0.7V
RP111N081D	J08	0.8V
RP111N091D	J09	0.9V
RP111N101D	J10	1.0V
RP111N111D	J11	1.1V
RP111N121D	J12	1.2V
RP111N131D	J13	1.3V
RP111N141D	J14	1.4V
RP111N151D	J15	1.5V
RP111N161D	J16	1.6V
RP111N171D	J17	1.7V
RP111N181D	J18	1.8V
RP111N191D	J19	1.9V
RP111N201D	J20	2.0V
RP111N211D	J21	2.1V
RP111N221D	J22	2.2V
RP111N231D	J23	2.3V
RP111N241D	J24	2.4V
RP111N251D	J25	2.5V
RP111N261D	J26	2.6V
RP111N271D	J27	2.7V
RP111N281D	J28	2.8V
RP111N291D	J29	2.9V
RP111N301D	J30	3.0V
RP111N311D	J31	3.1V
RP111N321D	J32	3.2V
RP111N331D	J33	3.3V
RP111N341D	J34	3.4V
RP111N351D	J35	3.5V
RP111N361D	J36	3.6V
RP111N071D5	J37	0.75V
RP111N121D5	J38	1.25V
RP111N181D5	J39	1.85V
RP111N281D5	J40	2.85V
RP111N101D5	J41	1.05V

• Power Dissipation (SOT-89-5)

Power Dissipation (P_D) depends on conditions of mounting on board. This specification is based on the Measurement Conditions below.

Measurement Conditions

	High Wattage Land Pattern	Standard Land Pattern
Environment	Mounting on Board (Wind Velocity=0m/s)	Mounting on Board (Wind Velocity=0m/s)
Board Material	Glass Cloth Epoxy Plastic (Double-sided)	Glass Cloth Epoxy Plastic (Double-sided)
Board Dimensions	30mm x 30mm x 1.6mm	50mm x 50mm x 1.6mm
Copper Ratio	Topside: Approx. 20% Backside: Approx. 100%	Topside: Approx. 10% Backside: Approx. 100%
Through-hole	$\phi 0.85\text{mm} \times 10\text{pcs}$	-

Measurement Result

($T_a=25^\circ\text{C}$)

	High Wattage Land Pattern	Standard Land Pattern	Free Air
Power Dissipation	1300mW	900mW ($T_{j\max}=125^\circ\text{C}$) 1125mW ($T_{j\max}=150^\circ\text{C}$)	500mW
Thermal Resistance	77°C/W	111°C/W	200°C/W

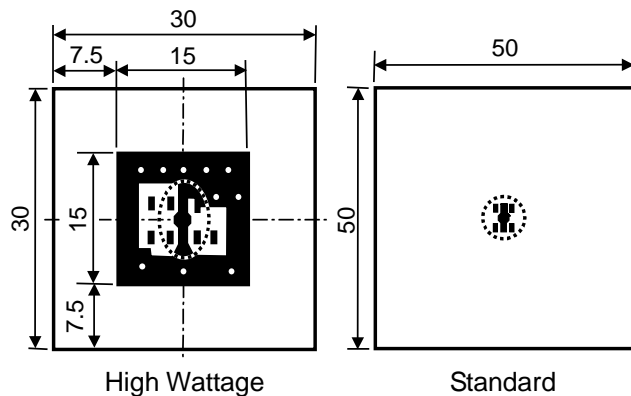
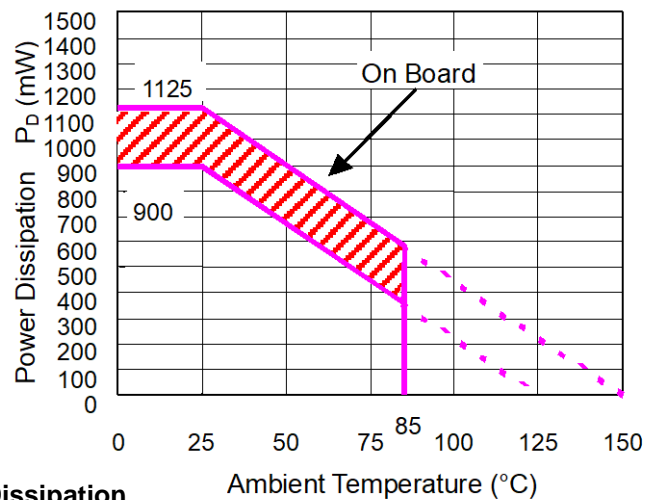
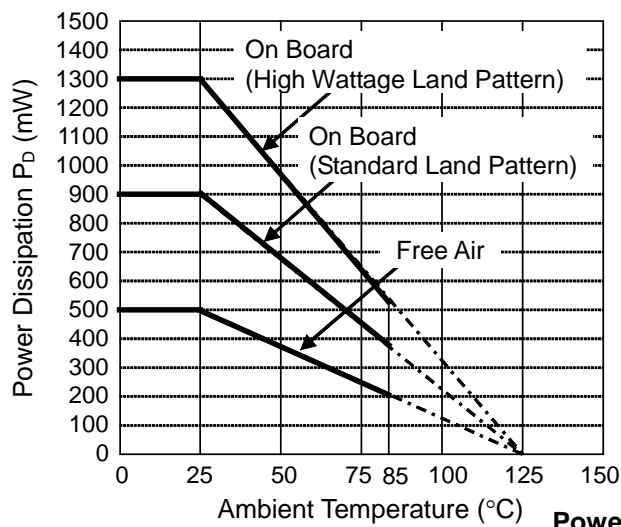

IC Mount Area Unit: mm

Note: The above graph shows the power dissipation of the package based on $T_{j\max}=125^\circ\text{C}$ and $T_{j\max}=150^\circ\text{C}$. Operating the IC within the shaded area in the graph might have an influence on its lifetime. Operating time must be within the time limit described in the table below.

Operating Time	Estimated years (Operating four hours/day)
13,000 hours	9 years

Package Dimensions (SOT-89-5)

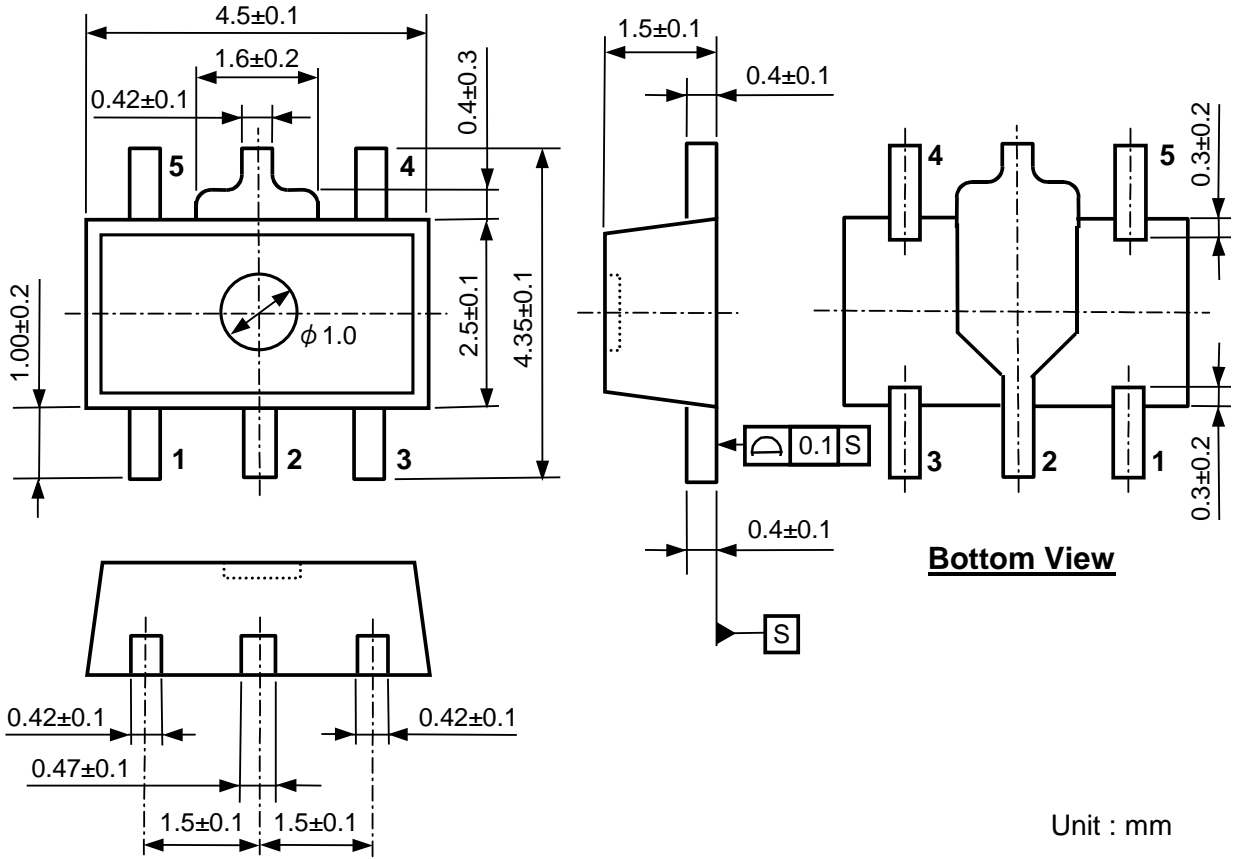

• Mark Specification (SOT-89-5)

- ①②③④: Product Code ... Refer to "RP111H Series Mark Specification Table".
- ⑤⑥ : Lot Number ... Alphanumeric Serial Number

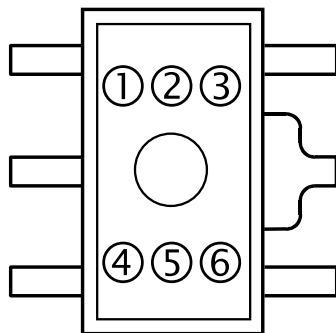

RP111H Series Mark Specification Table (SOT-89-5)

RP111Hxx1B

Product Name	①②③④	Vset
RP111H071B	A07B	0.7V
RP111H081B	A08B	0.8V
RP111H091B	A09B	0.9V
RP111H101B	A10B	1.0V
RP111H111B	A11B	1.1V
RP111H121B	A12B	1.2V
RP111H131B	A13B	1.3V
RP111H141B	A14B	1.4V
RP111H151B	A15B	1.5V
RP111H161B	A16B	1.6V
RP111H171B	A17B	1.7V
RP111H181B	A18B	1.8V
RP111H191B	A19B	1.9V
RP111H201B	A20B	2.0V
RP111H211B	A21B	2.1V
RP111H221B	A22B	2.2V
RP111H231B	A23B	2.3V
RP111H241B	A24B	2.4V
RP111H251B	A25B	2.5V
RP111H261B	A26B	2.6V
RP111H271B	A27B	2.7V
RP111H281B	A28B	2.8V
RP111H291B	A29B	2.9V
RP111H301B	A30B	3.0V
RP111H311B	A31B	3.1V
RP111H321B	A32B	3.2V
RP111H331B	A33B	3.3V
RP111H341B	A34B	3.4V
RP111H351B	A35B	3.5V
RP111H361B	A36B	3.6V
RP111H071B5	A37B	0.75V
RP111H121B5	A38B	1.25V
RP111H181B5	A39B	1.85V
RP111H281B5	A40B	2.85V
RP111H101B5	A41B	1.05V

RP111Hxx1D

Product Name	①②③④	Vset
RP111H071D	A07D	0.7V
RP111H081D	A08D	0.8V
RP111H091D	A09D	0.9V
RP111H101D	A10D	1.0V
RP111H111D	A11D	1.1V
RP111H121D	A12D	1.2V
RP111H131D	A13D	1.3V
RP111H141D	A14D	1.4V
RP111H151D	A15D	1.5V
RP111H161D	A16D	1.6V
RP111H171D	A17D	1.7V
RP111H181D	A18D	1.8V
RP111H191D	A19D	1.9V
RP111H201D	A20D	2.0V
RP111H211D	A21D	2.1V
RP111H221D	A22D	2.2V
RP111H231D	A23D	2.3V
RP111H241D	A24D	2.4V
RP111H251D	A25D	2.5V
RP111H261D	A26D	2.6V
RP111H271D	A27D	2.7V
RP111H281D	A28D	2.8V
RP111H291D	A29D	2.9V
RP111H301D	A30D	3.0V
RP111H311D	A31D	3.1V
RP111H321D	A32D	3.2V
RP111H331D	A33D	3.3V
RP111H341D	A34D	3.4V
RP111H351D	A35D	3.5V
RP111H361D	A36D	3.6V
RP111H071D5	A37D	0.75V
RP111H121D5	A38D	1.25V
RP111H181D5	A39D	1.85V
RP111H281D5	A40D	2.85V
RP111H101D5	A41D	1.05V

TEST CIRCUIT

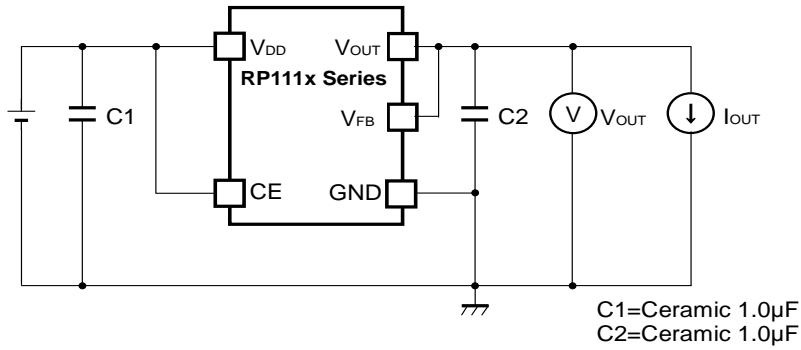

Basic Test Circuit

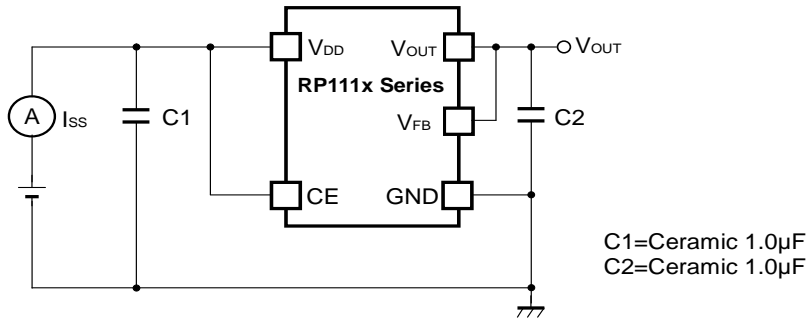

Test Circuit for Supply Current

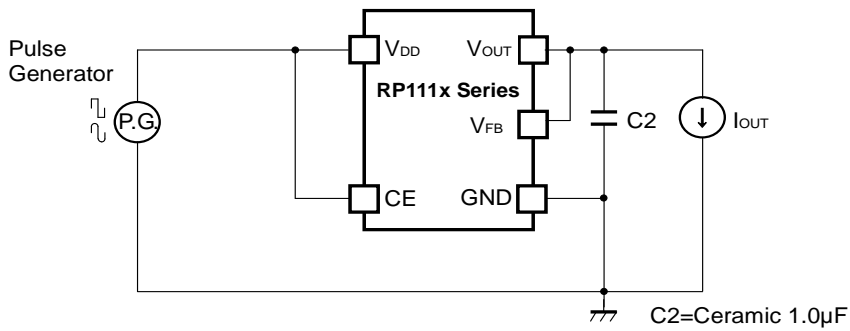

Test Circuit for Ripple Rejection

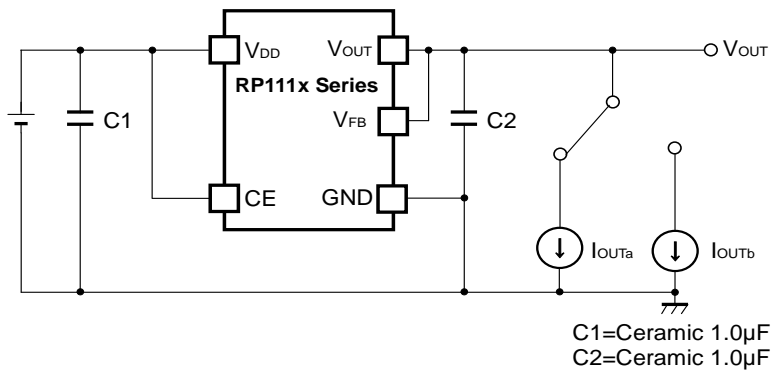

Test Circuit for Load Transient Response

TYPICAL CHARACTERISTICS

1) Output Voltage vs. Output Current (C1=1.0μF, C2=Ceramic 1.0μF, Ta=25°C)

RP111x071x

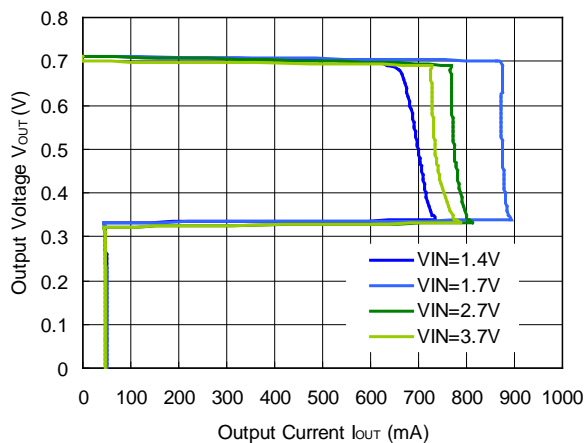

RP111x171x

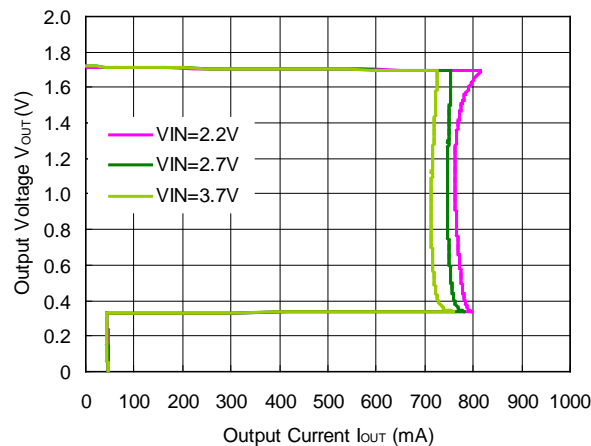

RP111x181x

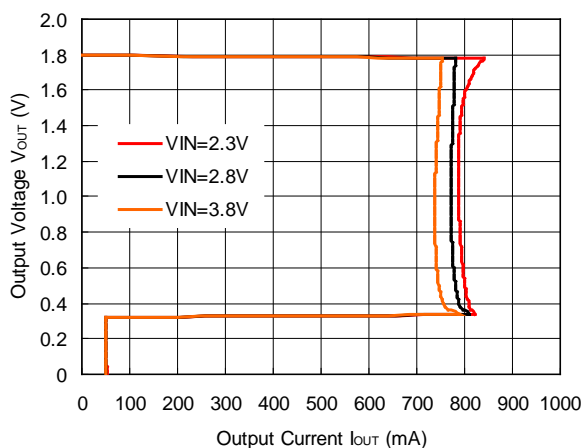

RP111x281x

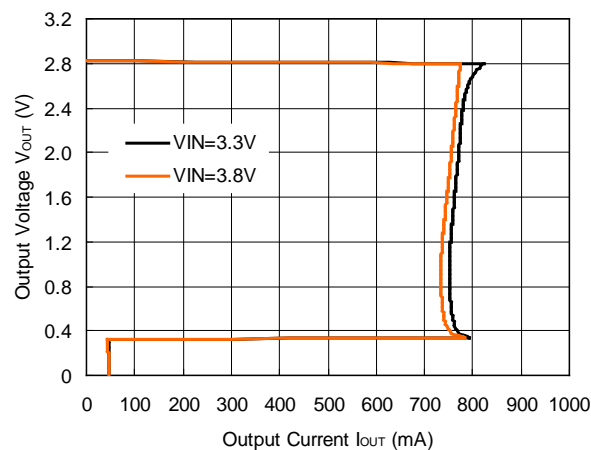

RP111x361x

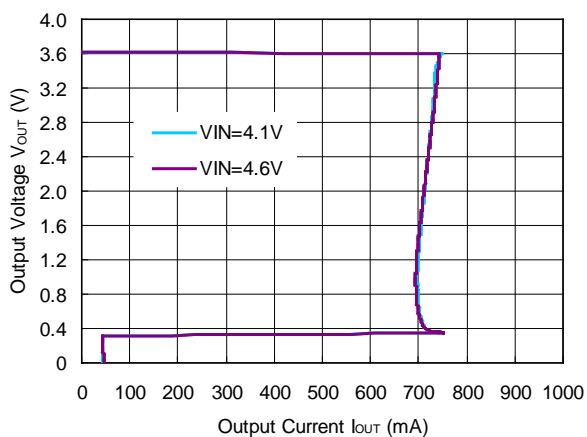

RP111x

NO.EA-241-190523

2) Output Voltage vs. Input Voltage (C1=Ceramic 1.0 μ F, C2=Ceramic 1.0 μ F, Ta=25°C)

RP111x071x

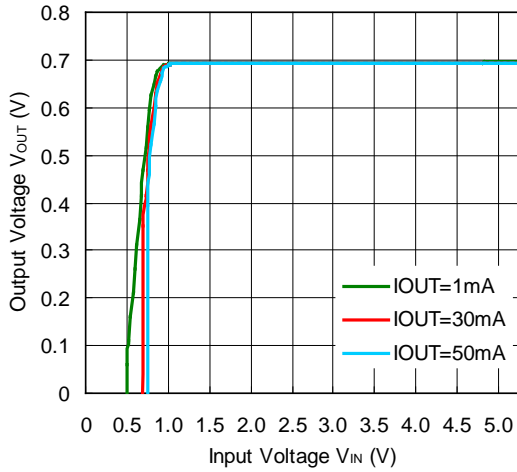

RP111x171x

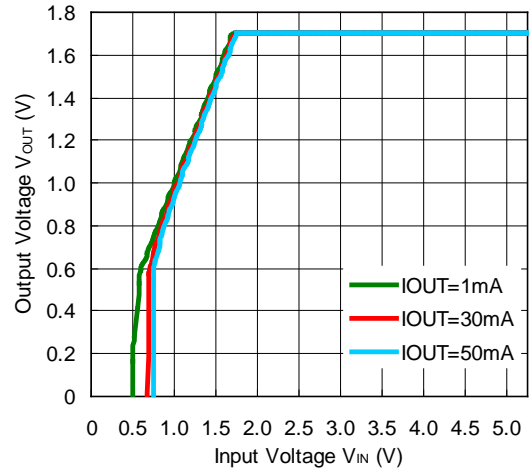

RP111x181x

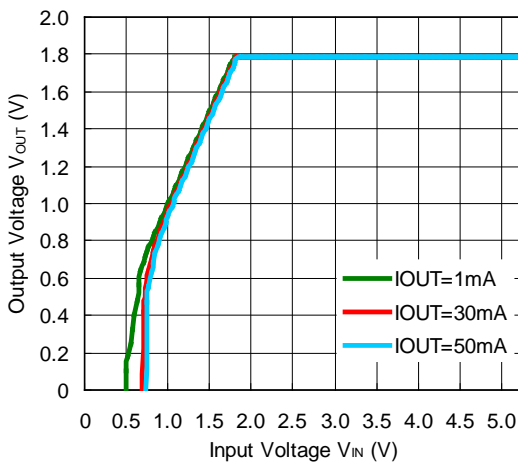

RP111x281x

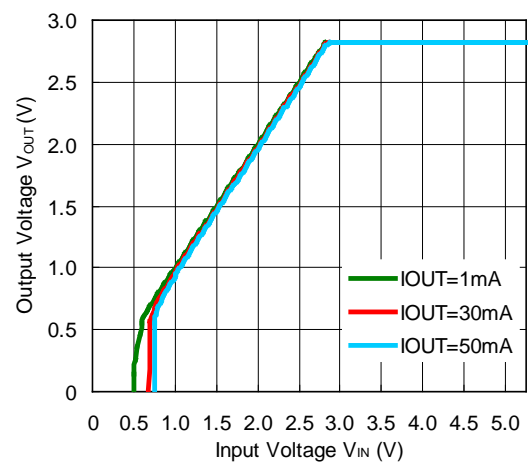

RP111x361x

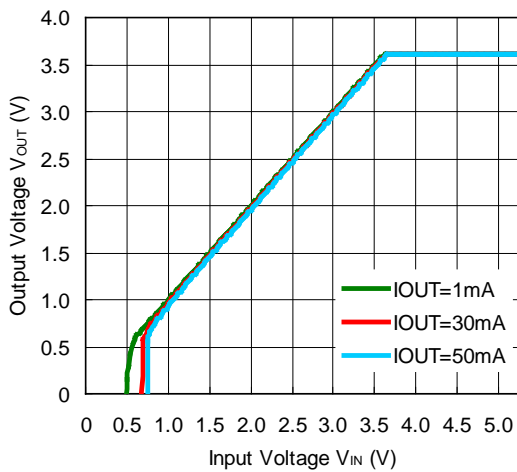

3) Supply Current vs. Input Voltage (C1=Ceramic 1.0 μ F, C2=Ceramic 1.0 μ F, Ta=25°C)

RP111x071x

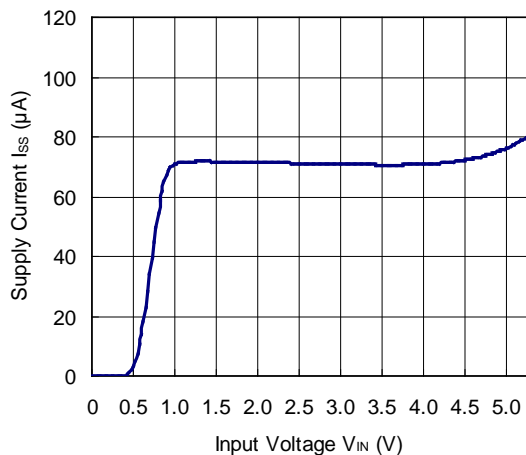

RP111x171x

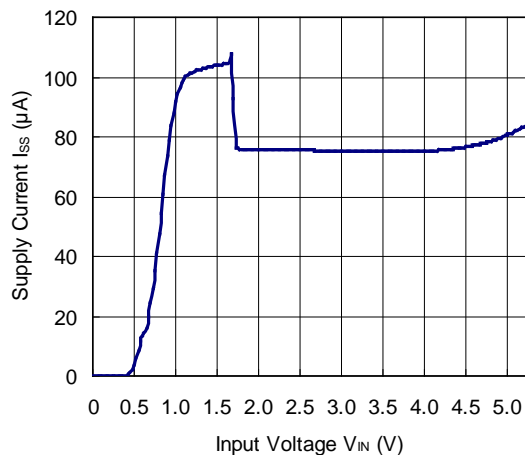

RP111x181x

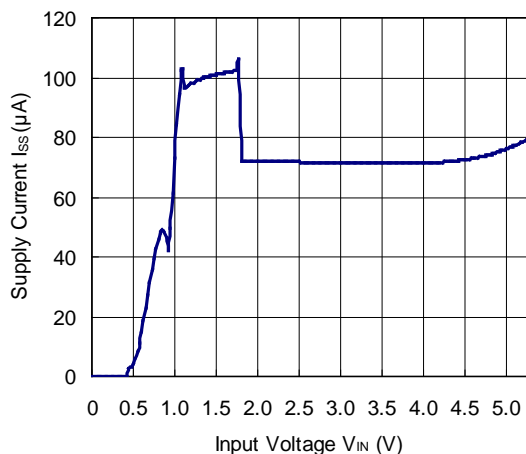

RP111x281x

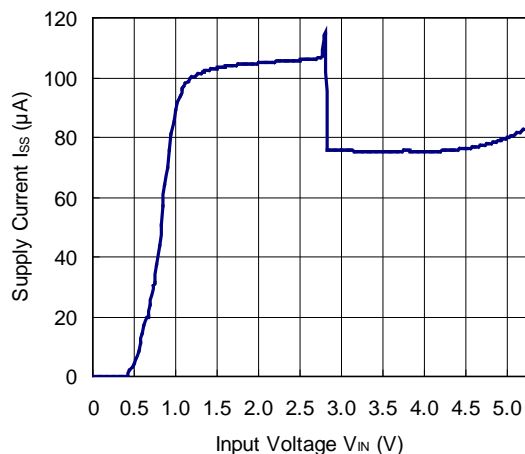

RP111x361x

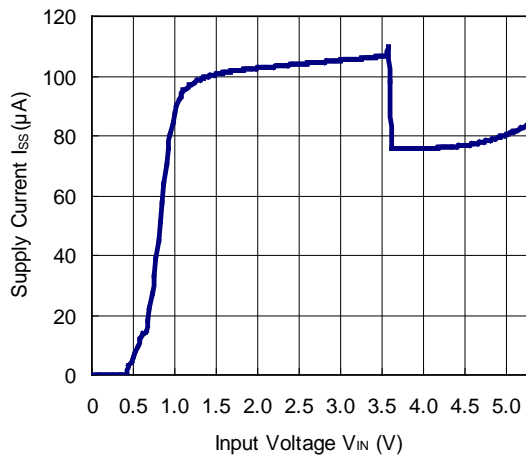

RP111xNO.EA-241-190523

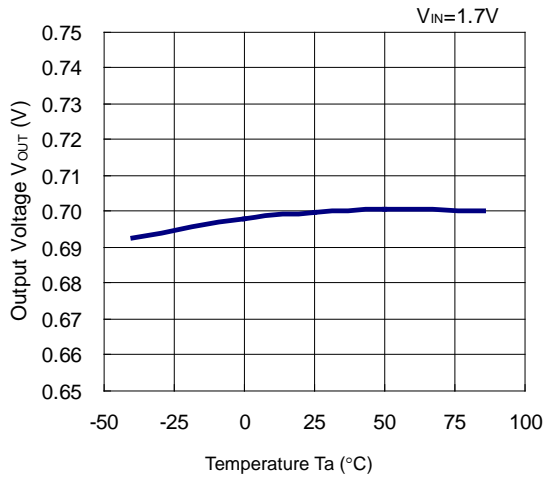
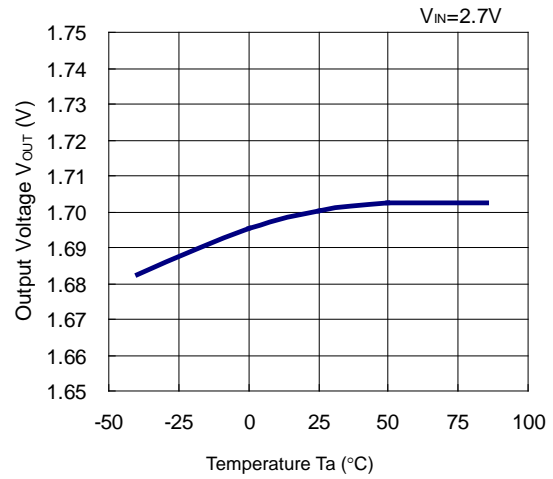
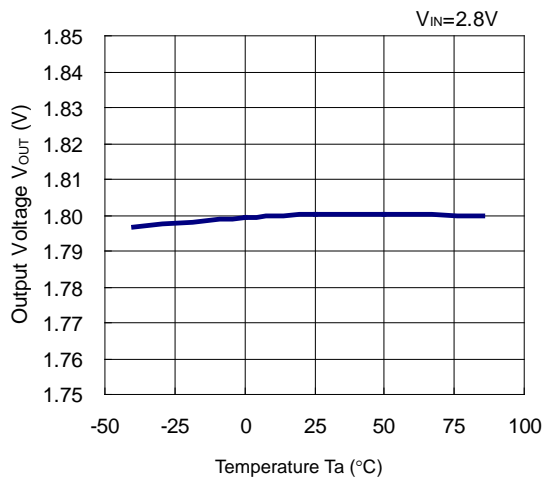
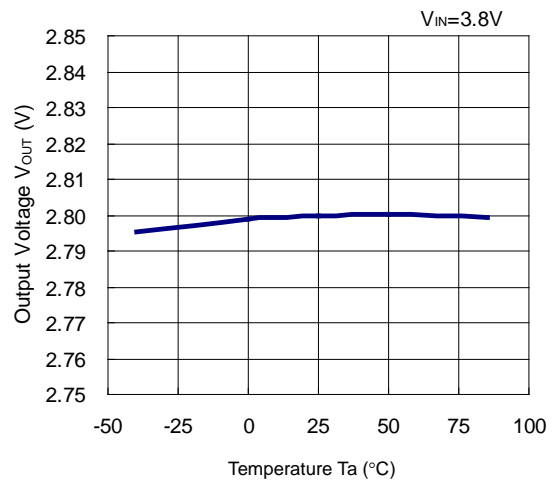
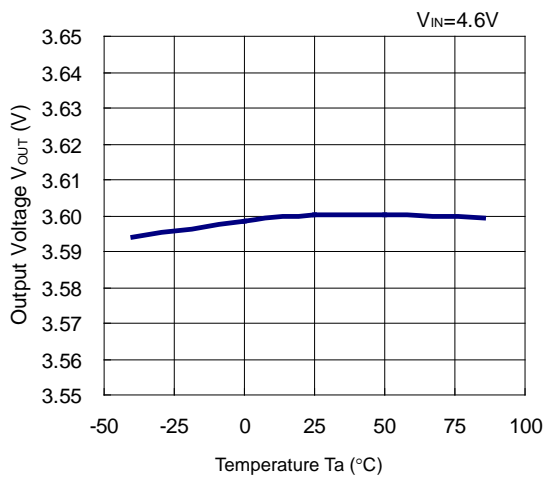
4) Output Voltage vs. Temperature (C1=Ceramic 1.0 μ F, C2=Ceramic 1.0 μ F, I_{OUT}=1mA)**RP111x071x****RP111x171x****RP111x181x****RP111x281x****RP111x361x**

5) Supply Current vs. Temperature (C1=Ceramic 1.0μF, C2=Ceramic 1.0μF, I_{OUT}=0mA)

RP111x071x

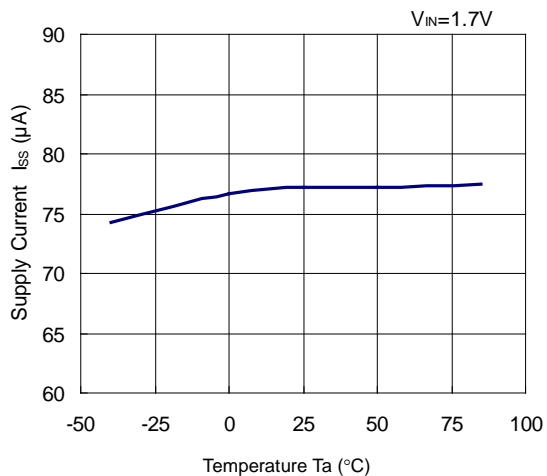

RP111x171x

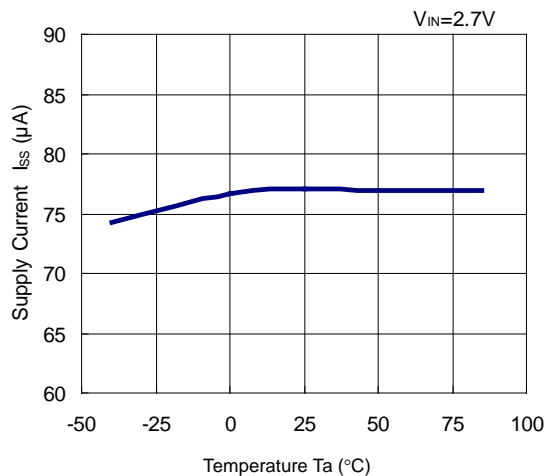

RP111x181x

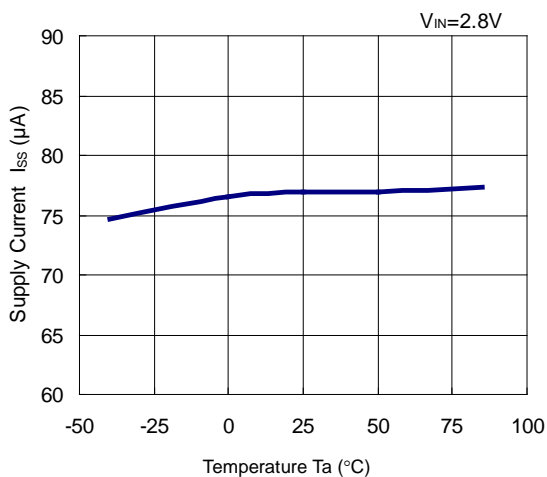

RP111x281x

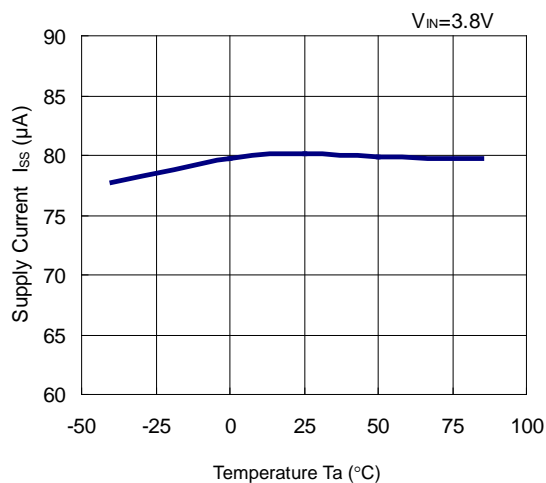

RP111x361x

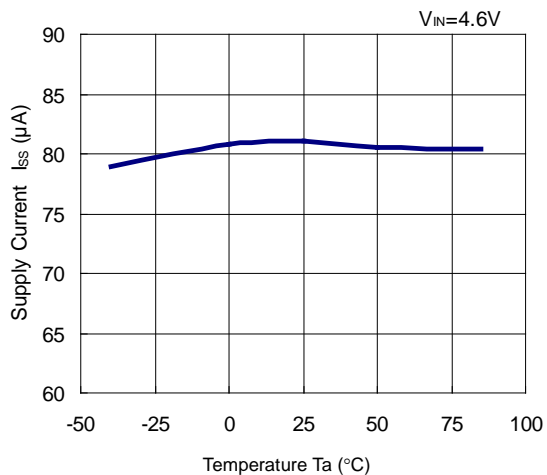

RP111x

NO.EA-241-190523

6) Dropout Voltage vs. Output Current (C1=Ceramic 1.0 μ F, C2=Ceramic 1.0 μ F)

RP111x071x

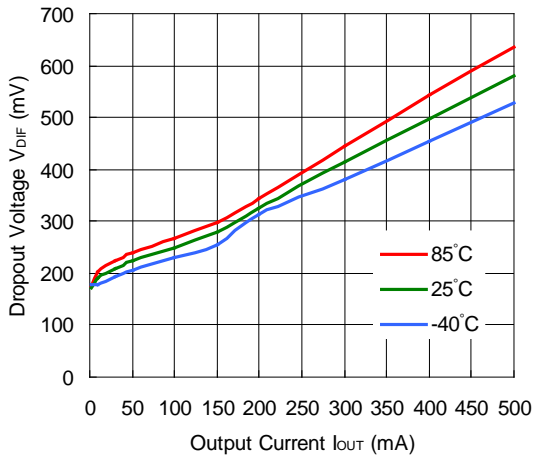

RP111x171x

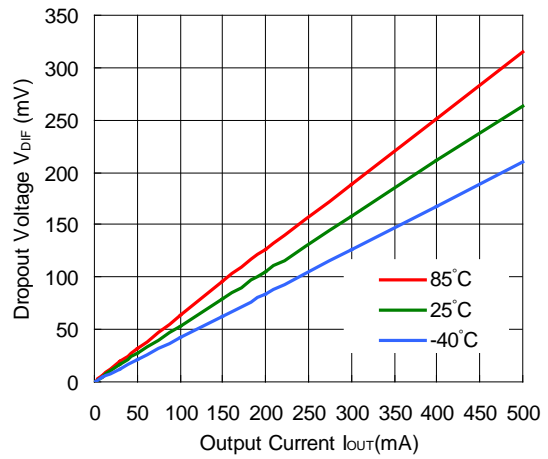

RP111x181x

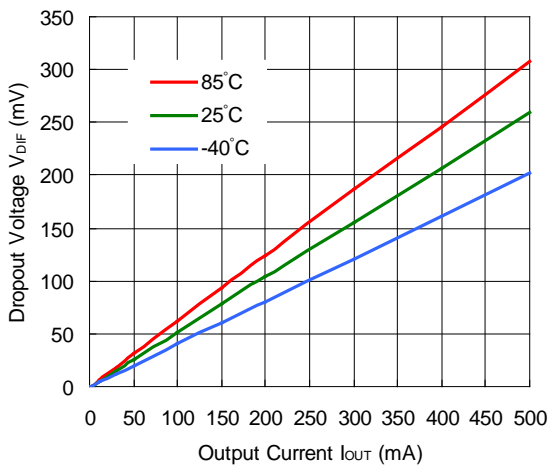

RP111x281x

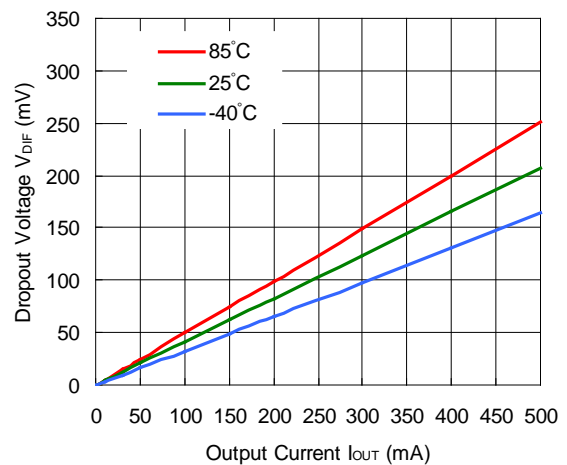

RP111x361x

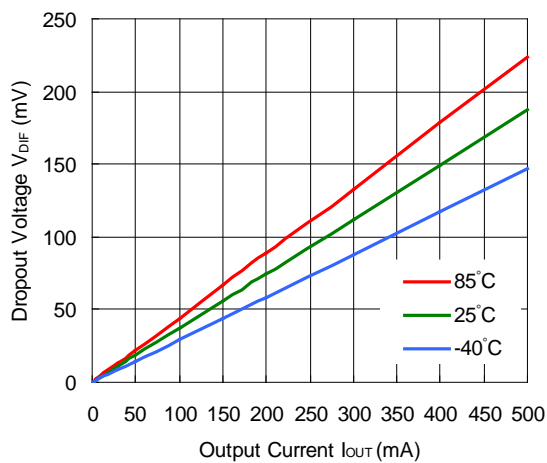

7) Dropout Voltage vs. Set Output Voltage (C1=Ceramic 1.0μF, C2=Ceramic 1.0μF, Ta=25°C)

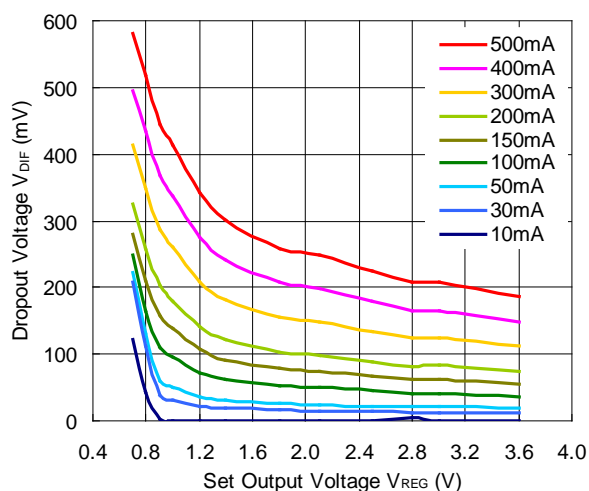

8) Dropout Voltage vs. Temperature (C1=Ceramic 1.0μF, C2=Ceramic 1.0μF)

RP111x071x

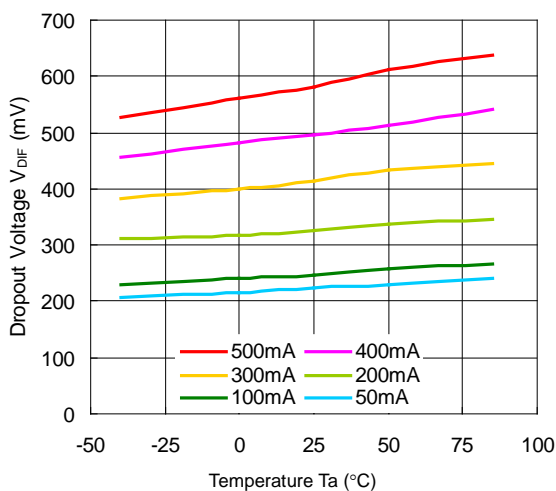

RP111x171xx

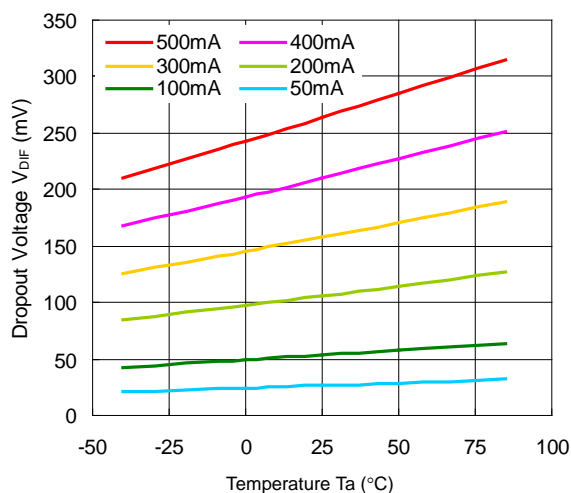

RP111x181x

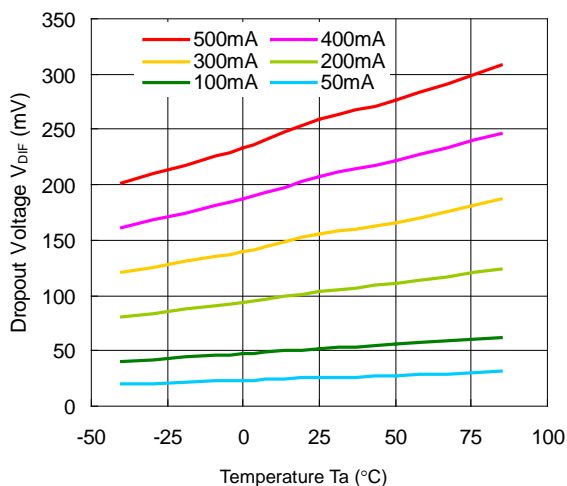

RP111x281x

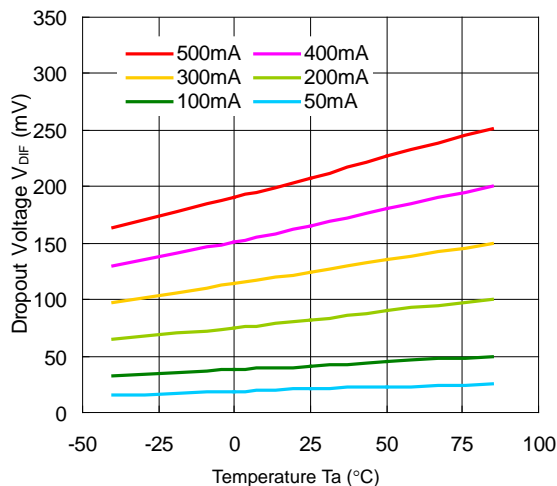

RP111x

NO.EA-241-190523

RP111x361x

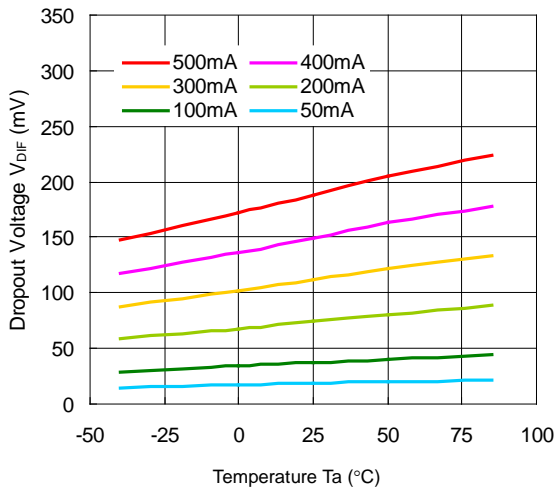

9) Ripple Rejection vs. Input Voltage (C1=none, C2=Ceramic 1.0μF, Ripple=0.2Vp-p, Ta=25°C)

RP111x071x

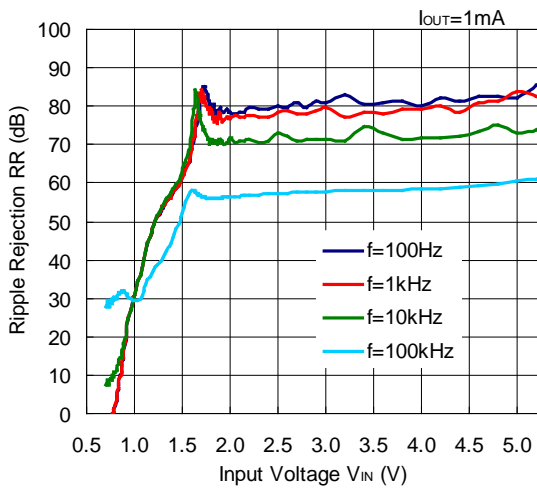

RP111x071x

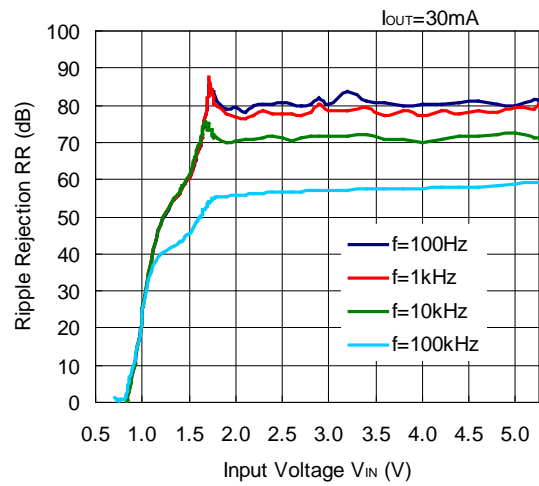

RP111x171x

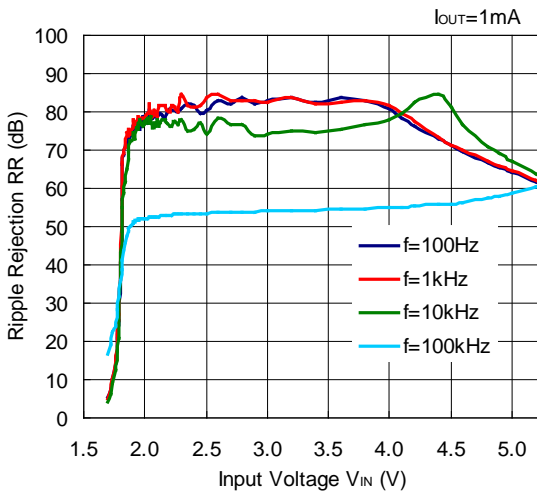

RP111x171x

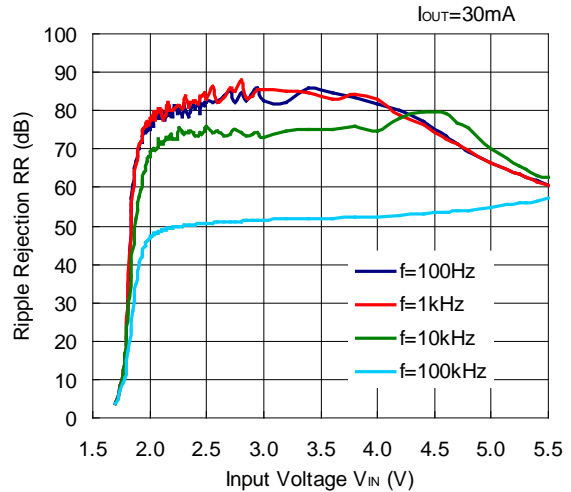

RP111x181x

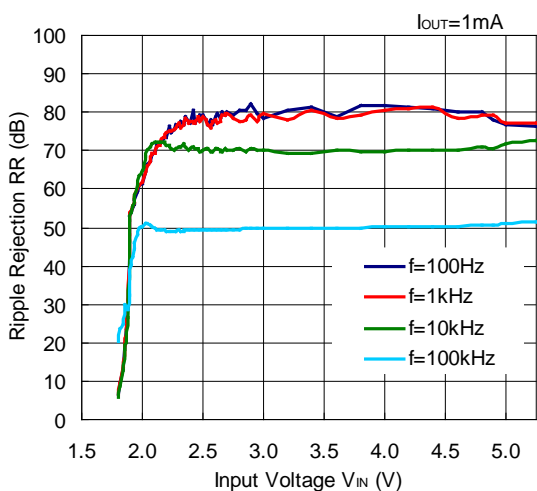

RP111x181x

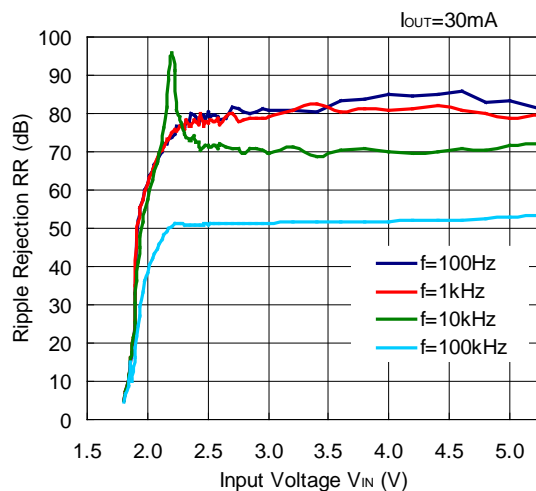

RP111x281x

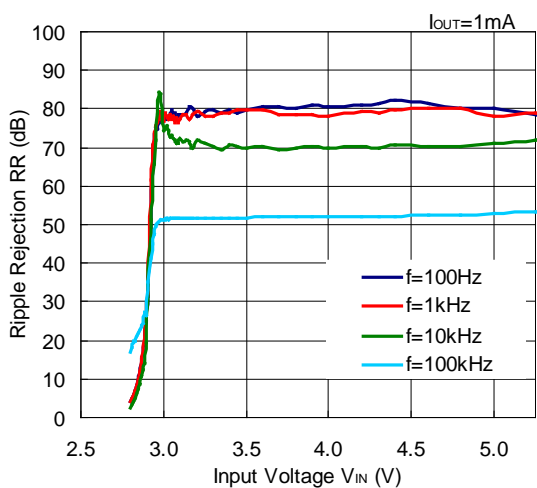

RP111x281x

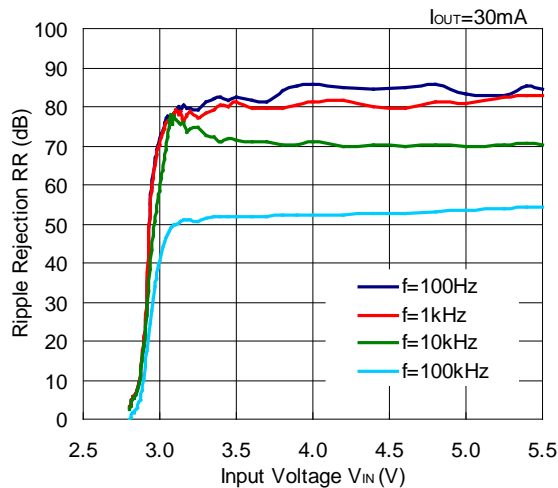

RP111x361x

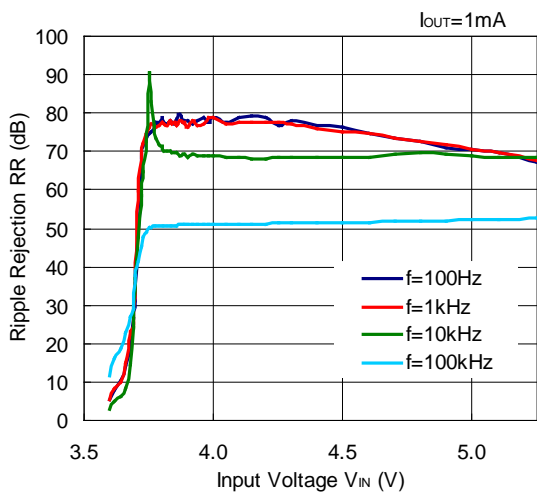

RP111x361x

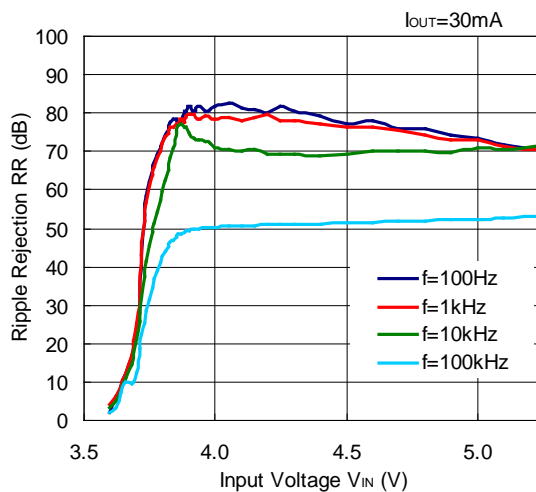

10) Ripple Rejection vs. Frequency (C1=none, C2=Ceramic 1.0μF, Ripple=0.2Vp-p, Ta=25°C)

RP111x071x

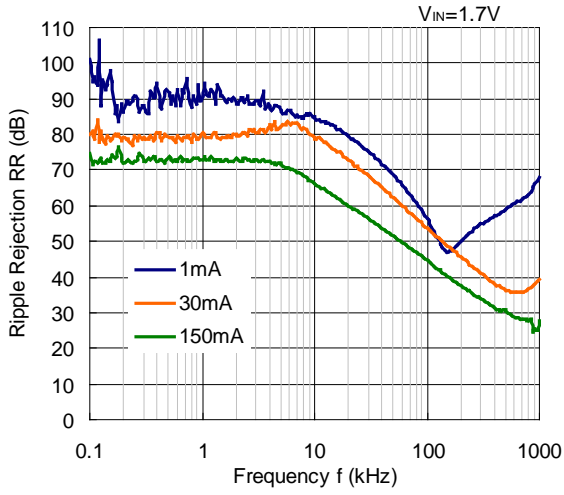

RP111x171x

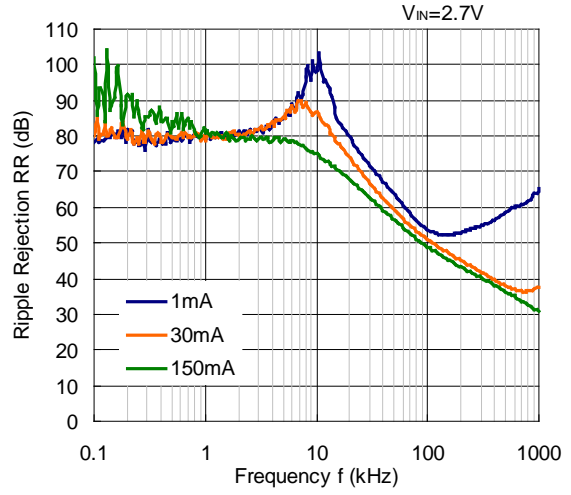

RP111x181x

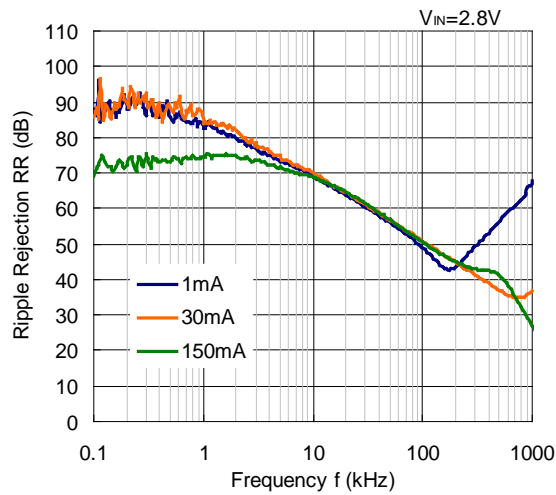

RP111x281x

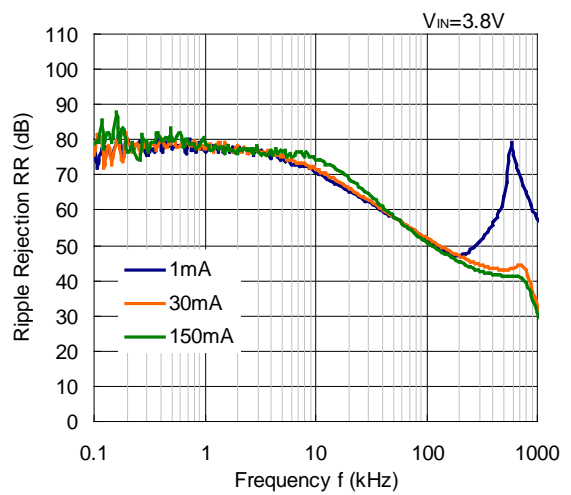

RP111x361x

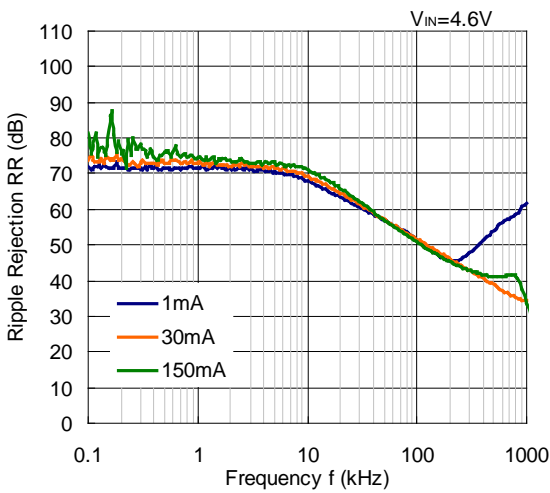

11) Input Transient Response (C1=none, C2=Ceramic 1.0μF, I_{OUT}=30mA, tr=tf=5μs, Ta=25°C)

RP111x071x

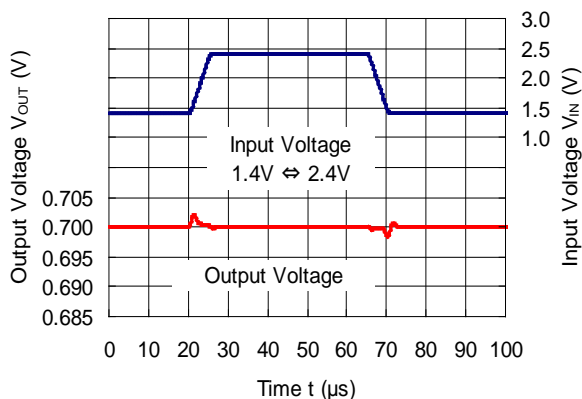

RP111x171x

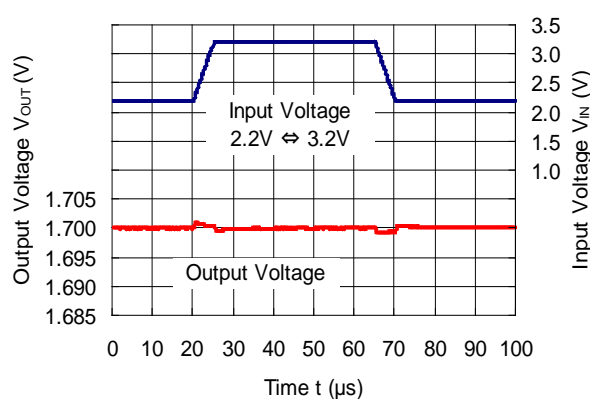

RP111x181x

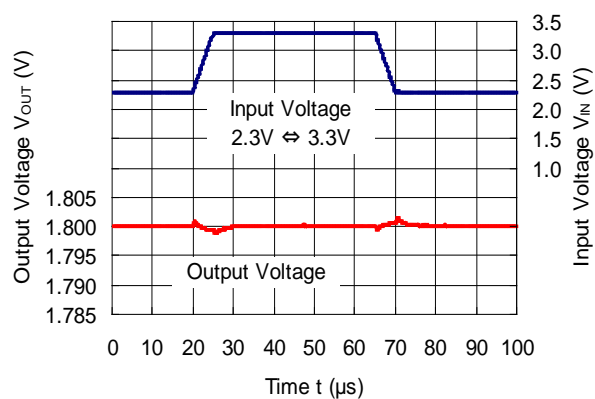

RP111x281x

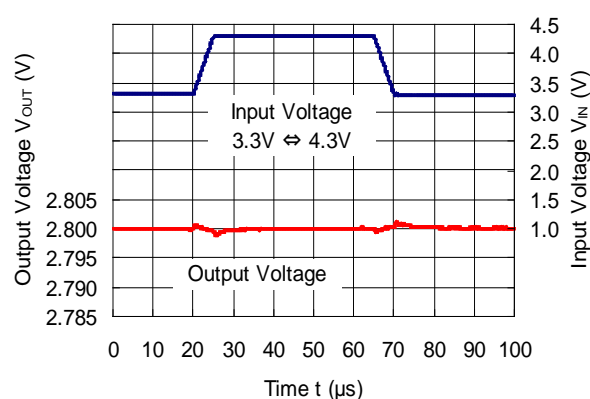

RP111x361x

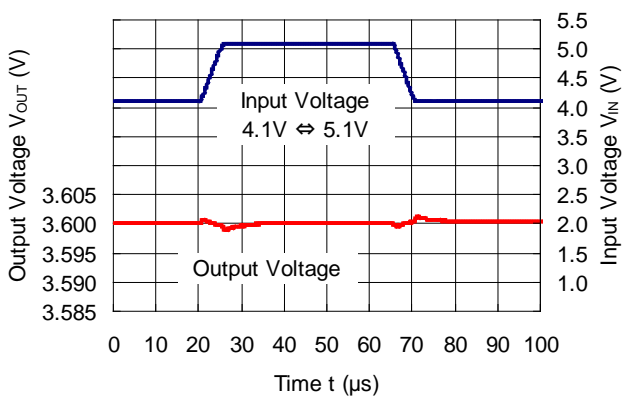

12) Load Transient Response (C1=Ceramic 1.0μF, C2=Ceramic 1.0μF, Ta=25°C)

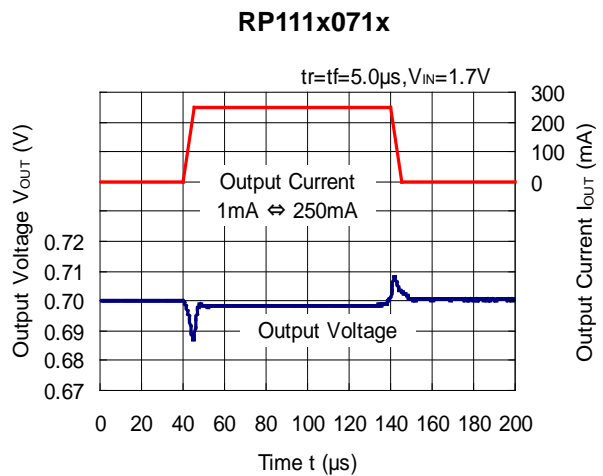
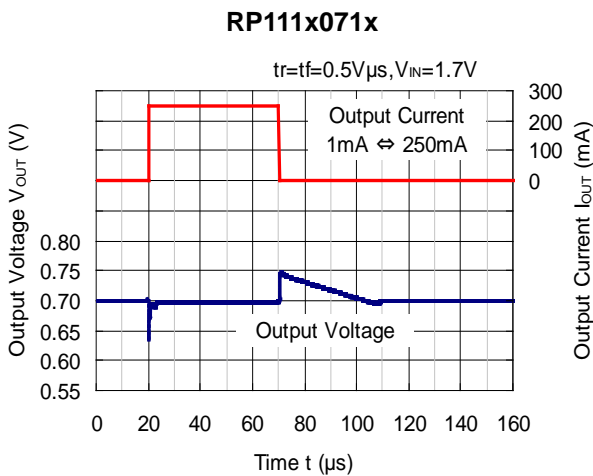
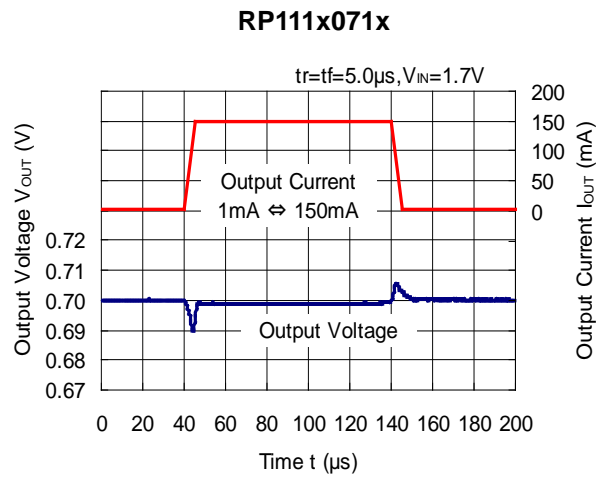
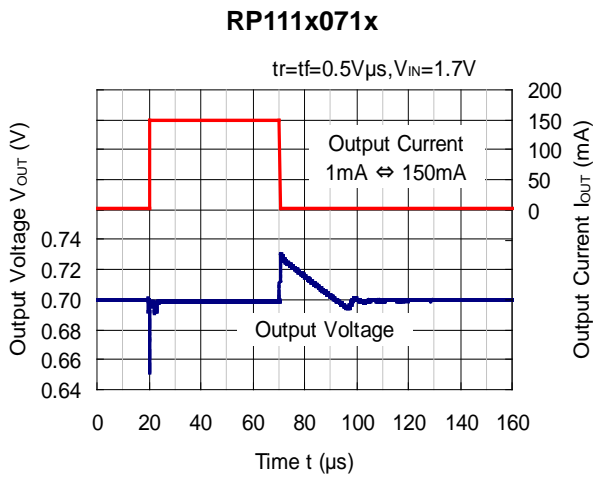
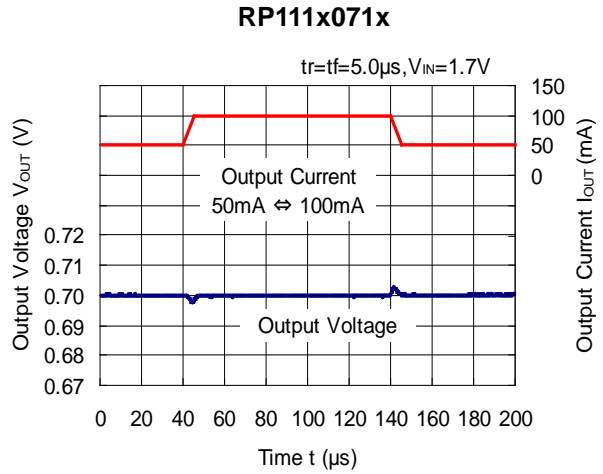
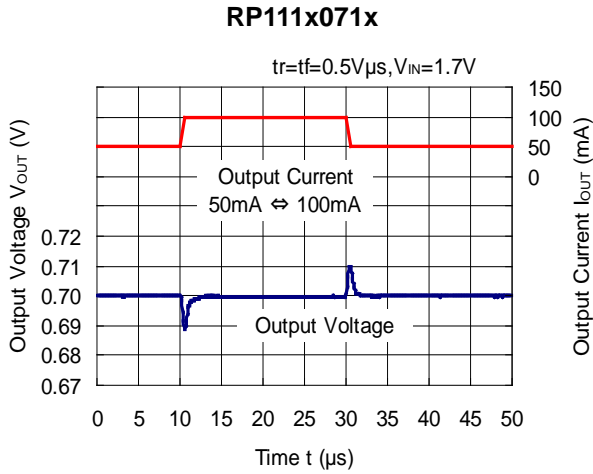

RP111x171x

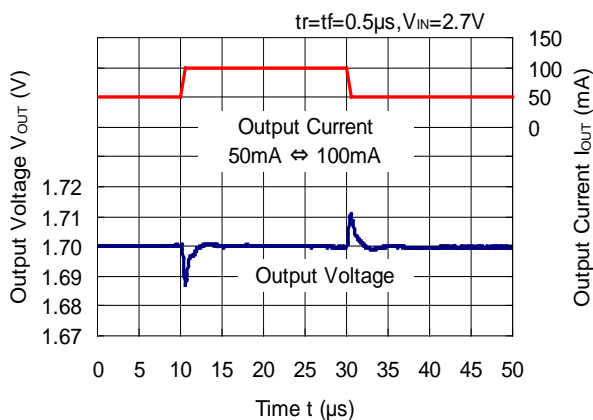

RP111x171x

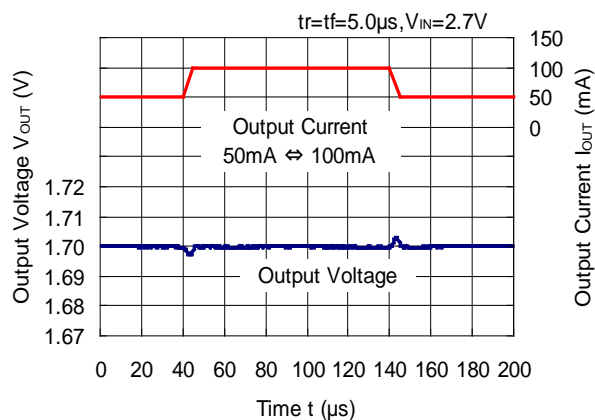

RP111x171x

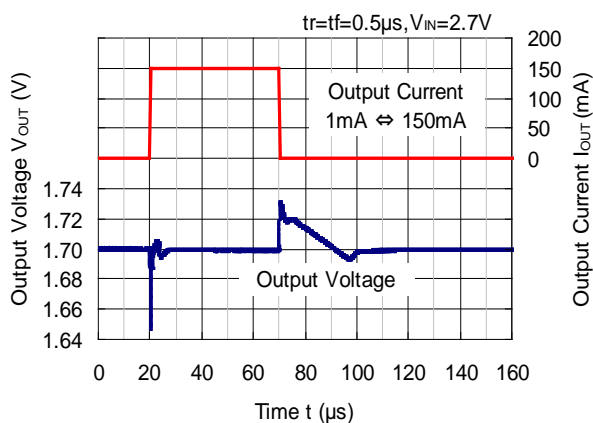

RP111x171x

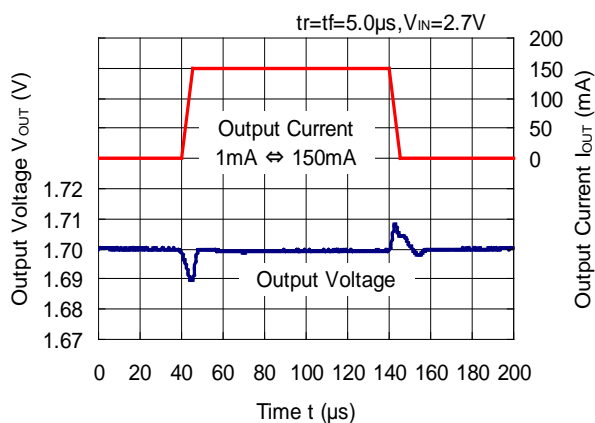

RP111x171x

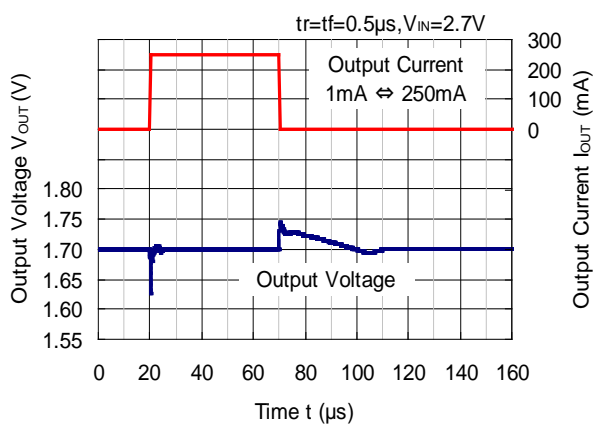

RP111x171x

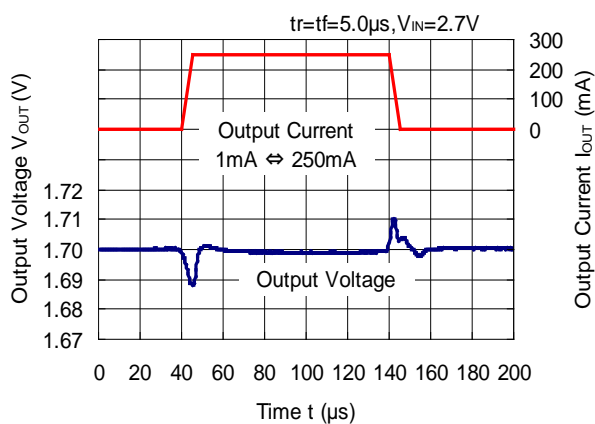

RP111x181x

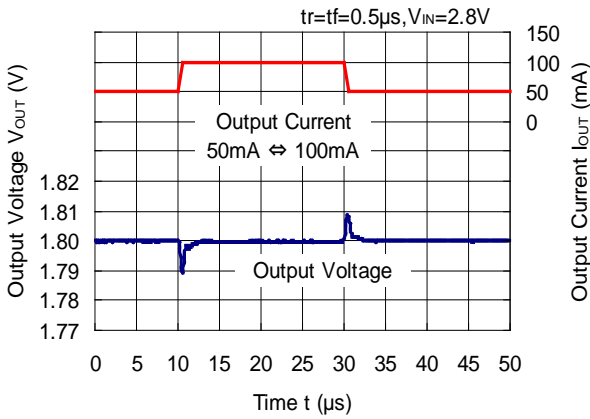

RP111x181x

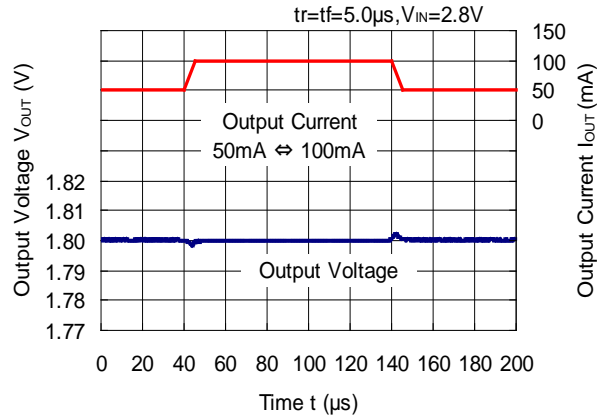

RP111x181x

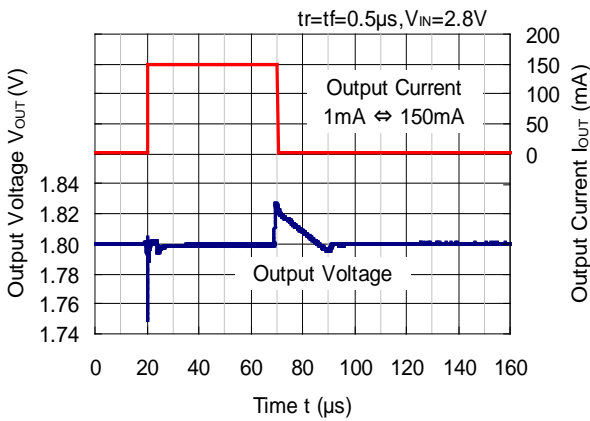

RP111x181x

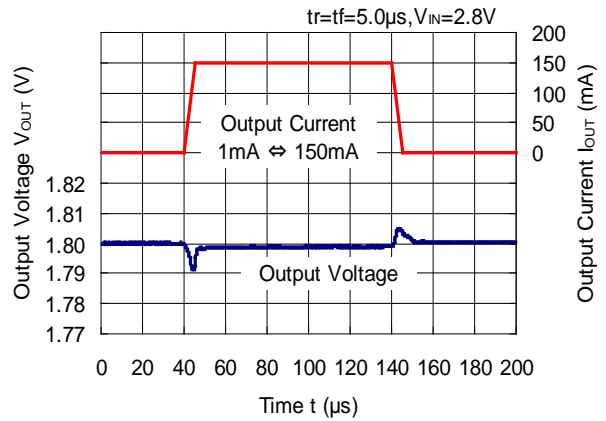

RP111x181x

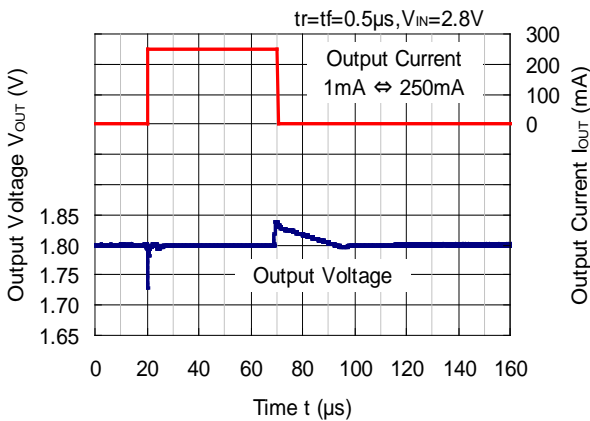

RP111x181x

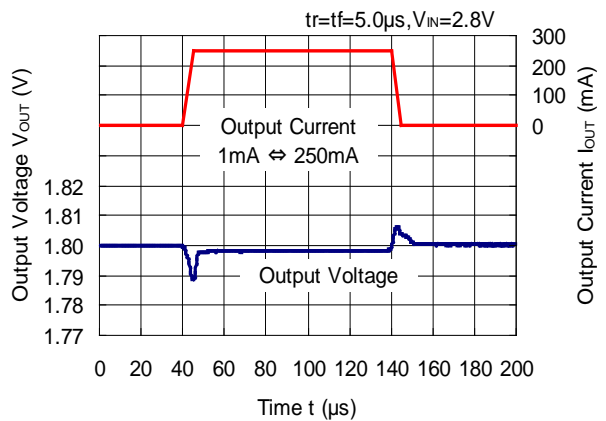

RP111x281x

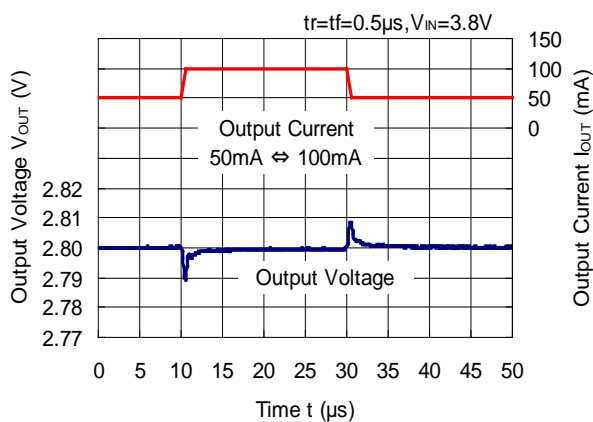

RP111x281x

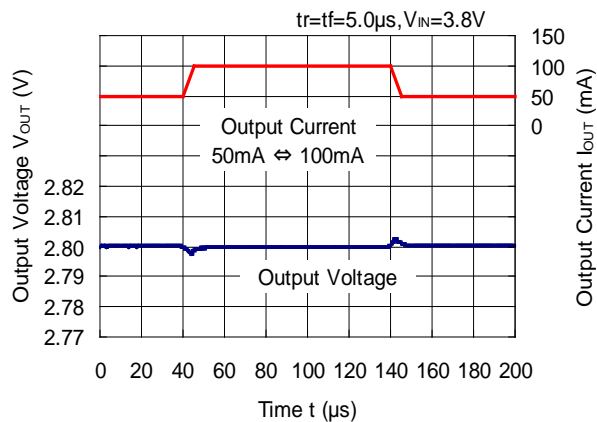

RP111x281x

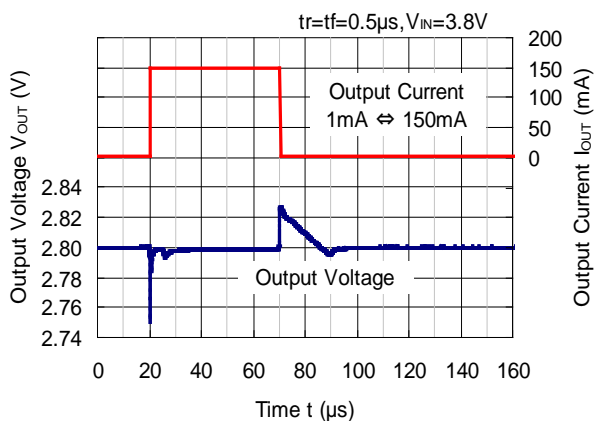

RP111x281x

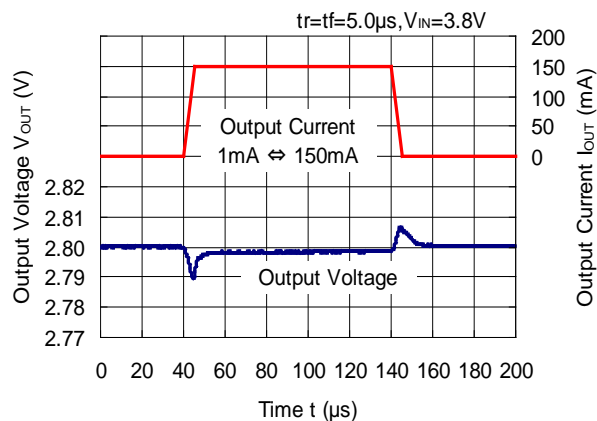

RP111x281x

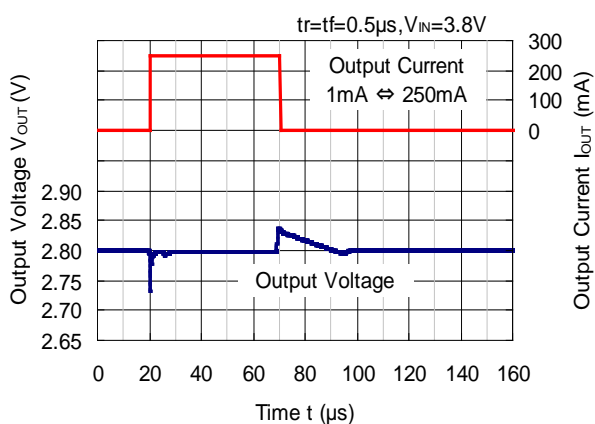

RP111x281x

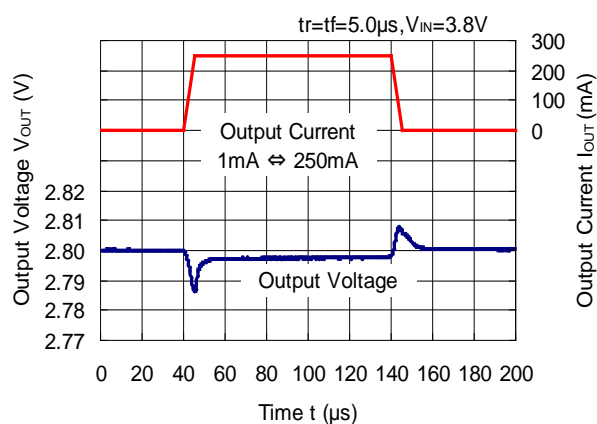

RP111x361x

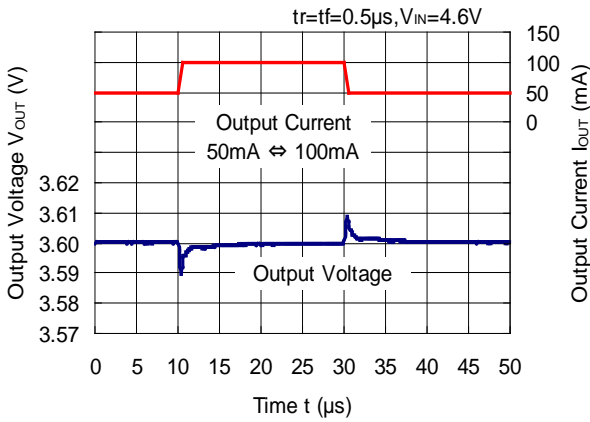

RP111x361x

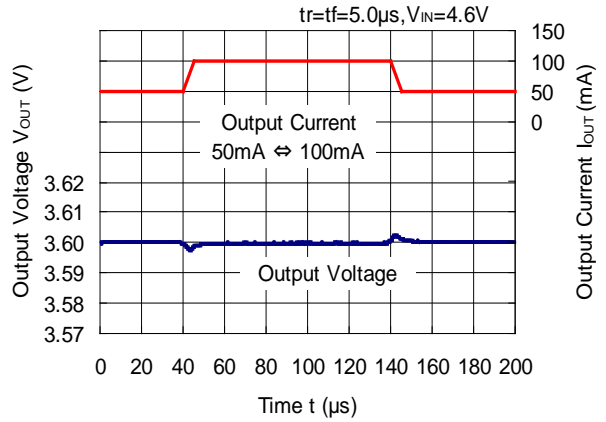

RP111x361x

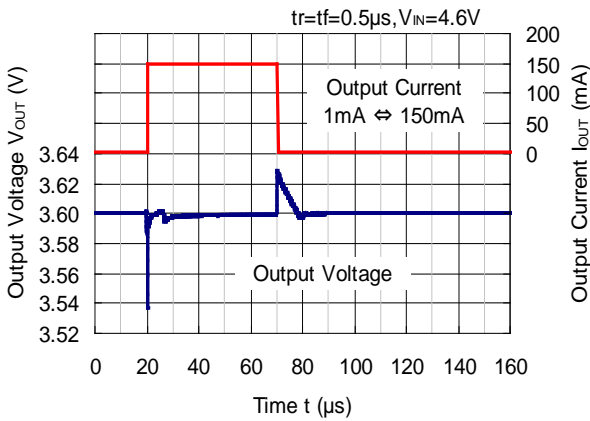

RP111x361x

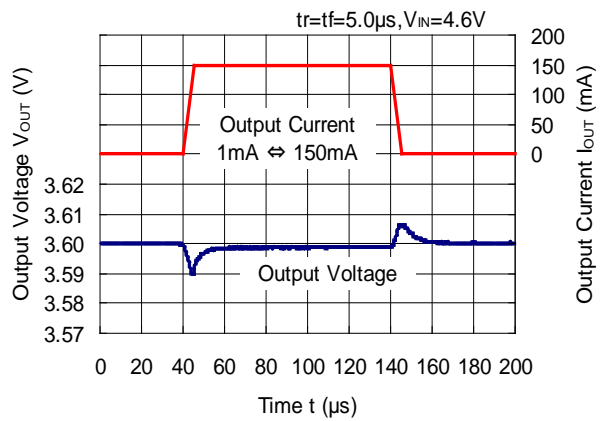

RP111x361x

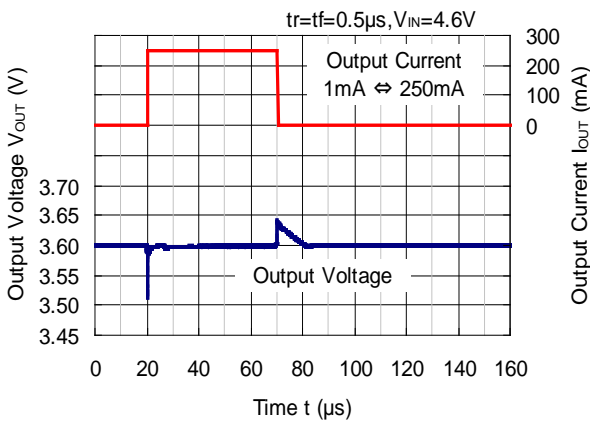

RP111x361x

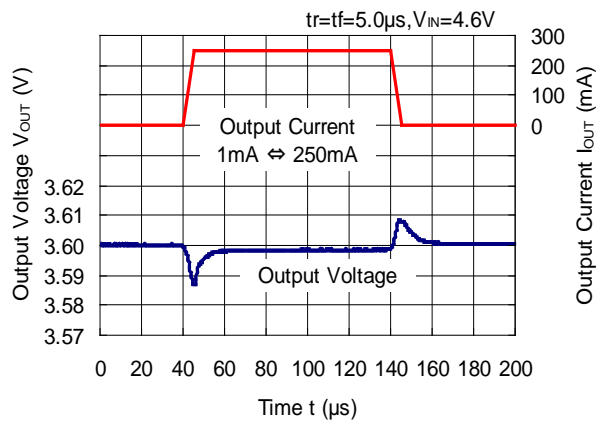

13) Turn on Speed with CE pin (C1=Ceramic 1.0 μ F, C2=Ceramic 1.0 μ F, Ta=25°C)

RP111x071x

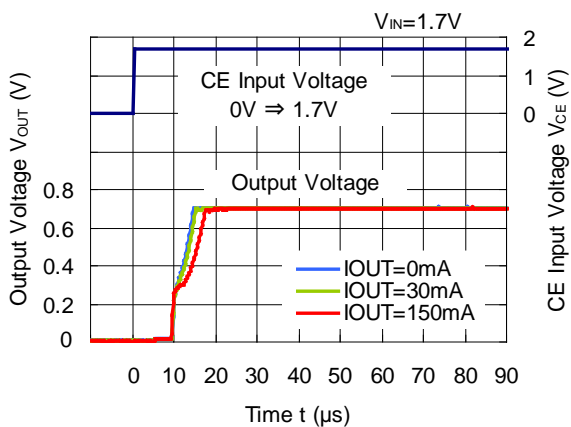

RP111x171x

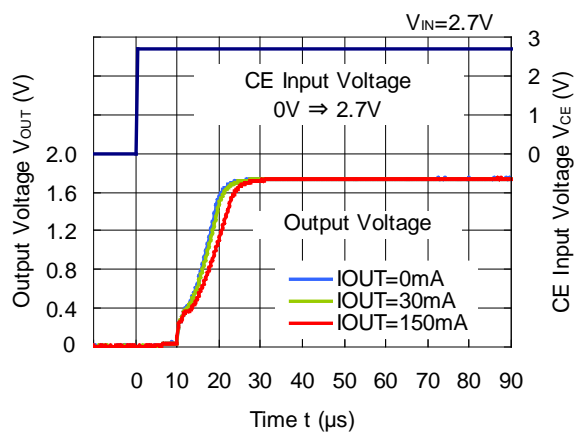

RP111x181x

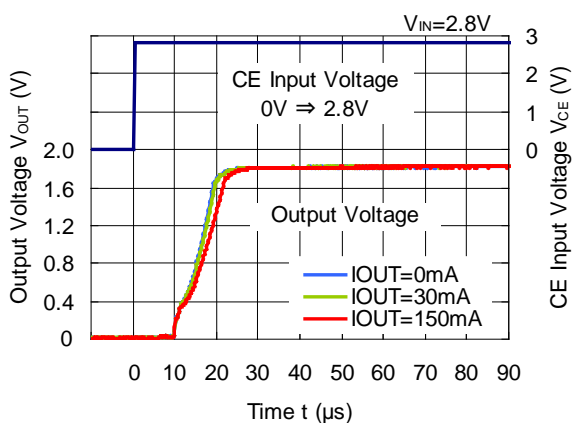

RP111x281x

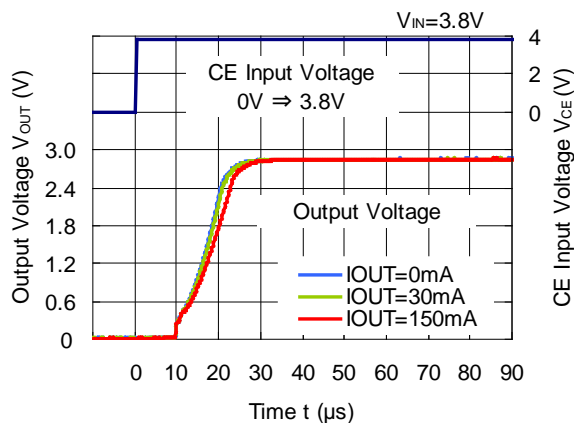

RP111x361

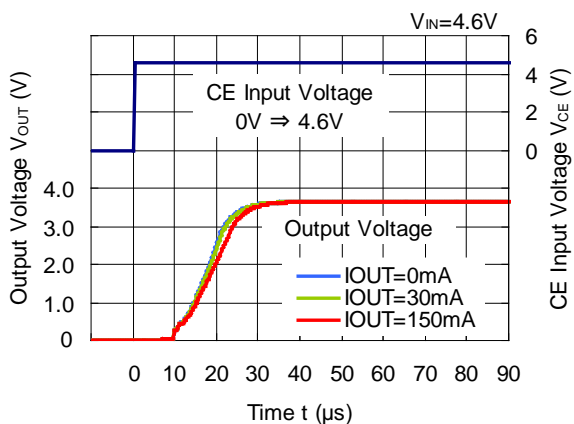

14) Turn off Speed with CE pin (C1=Ceramic 1.0μF, C2=Ceramic 1.0μF, Ta=25°C)

RP111x071D

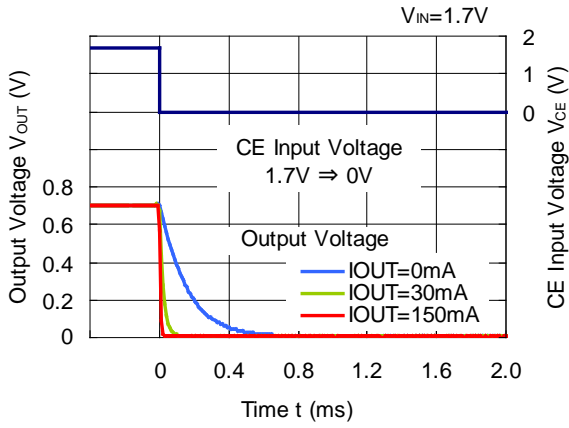

RP111x171D

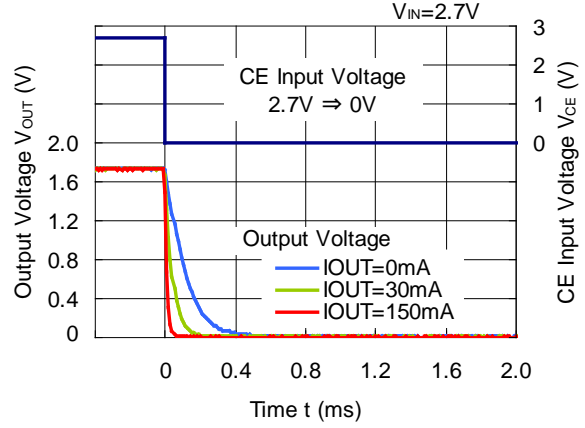

RP111x181D

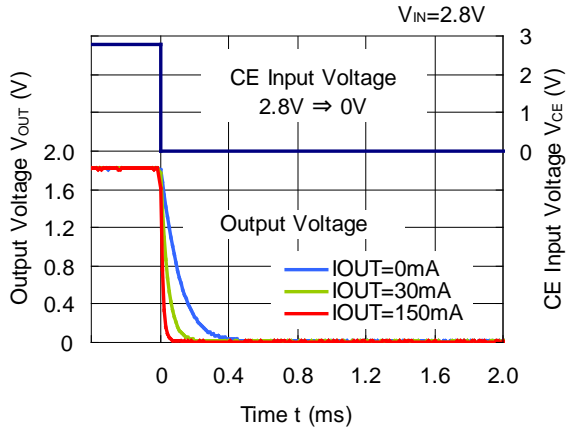

RP111x281D

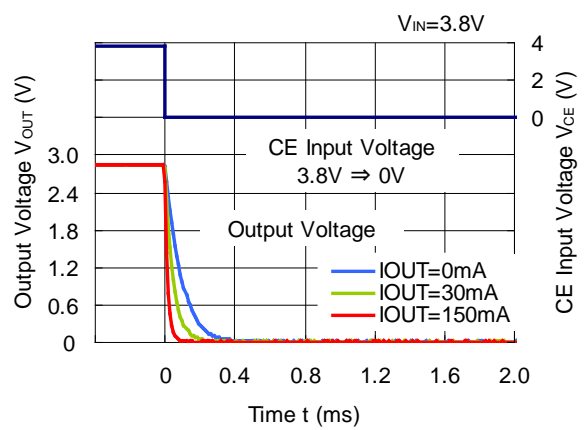

RP111x361D

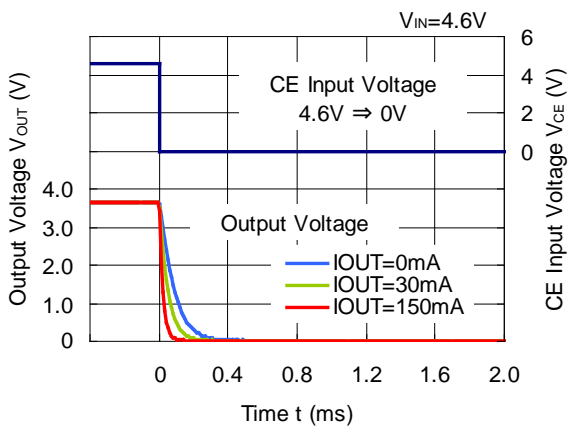

15) Inrush Current (C1=Ceramic 1.0μF, I_{OUT}=0mA, Ta=25°C)

RP111x071x

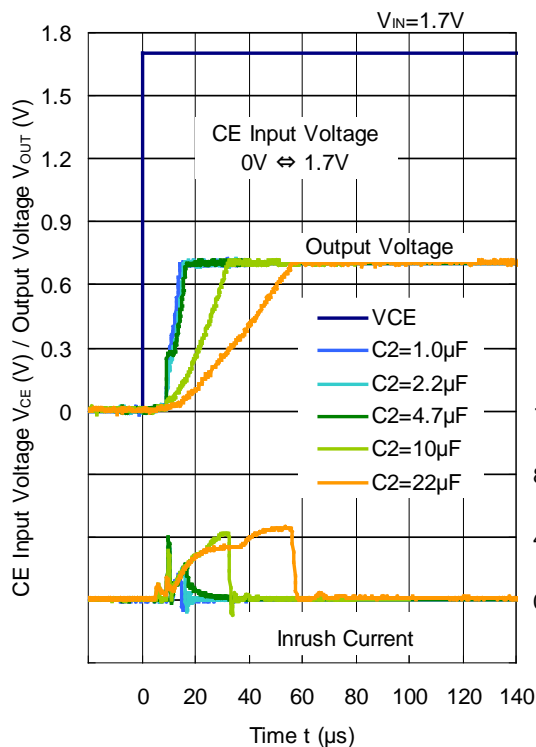

RP111x071x

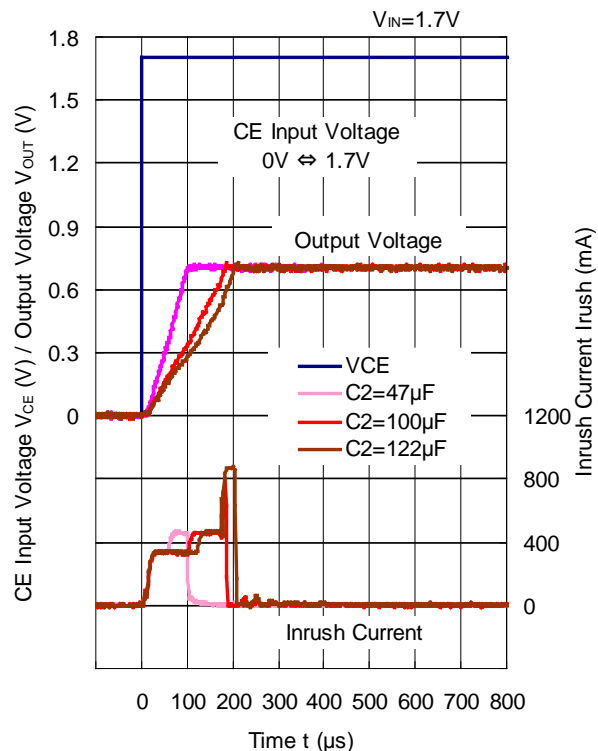

RP111x171x

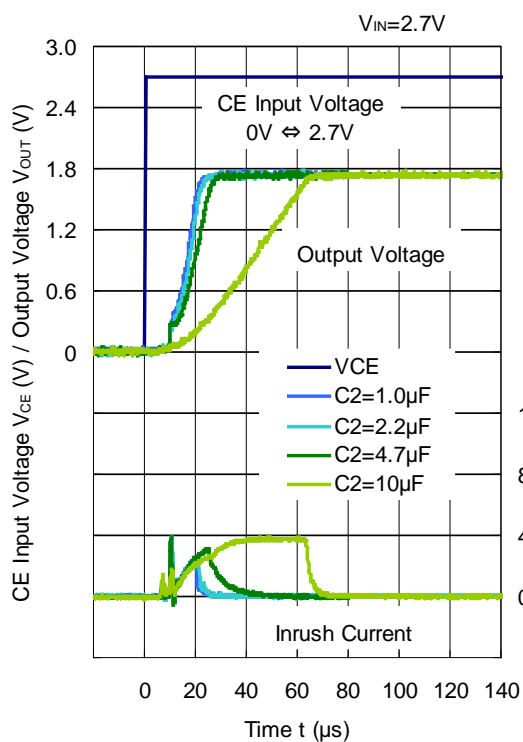

RP111x171x

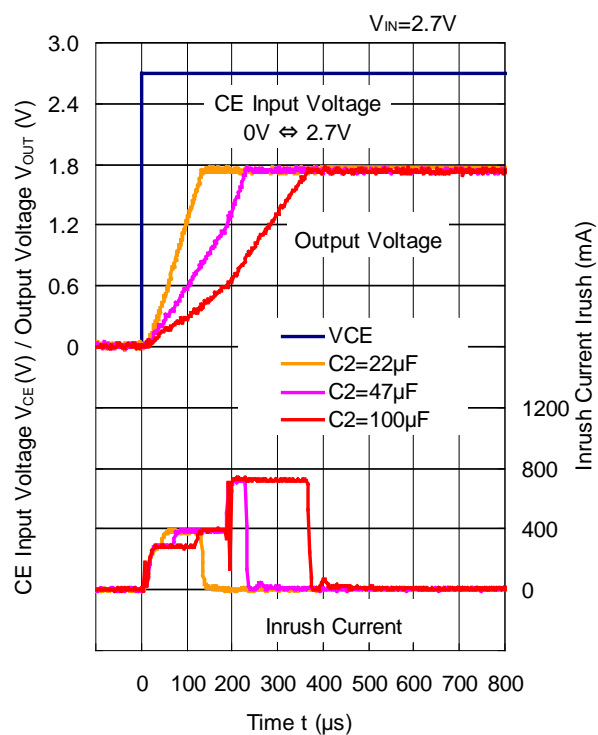

RP111x181x

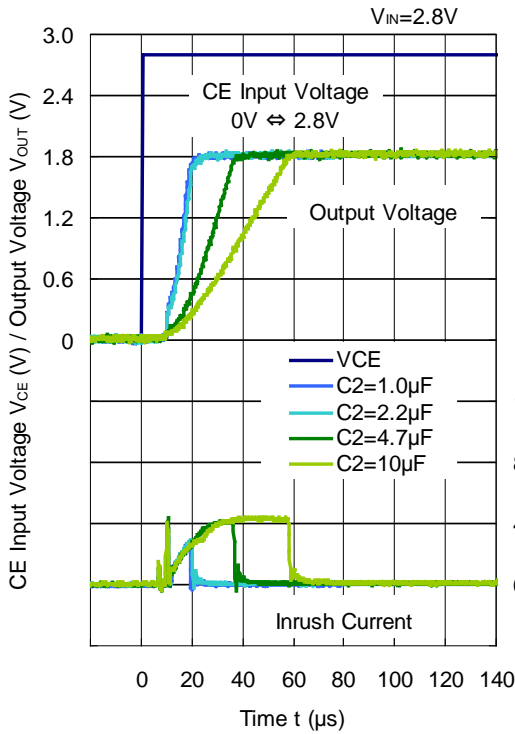

RP111x181x

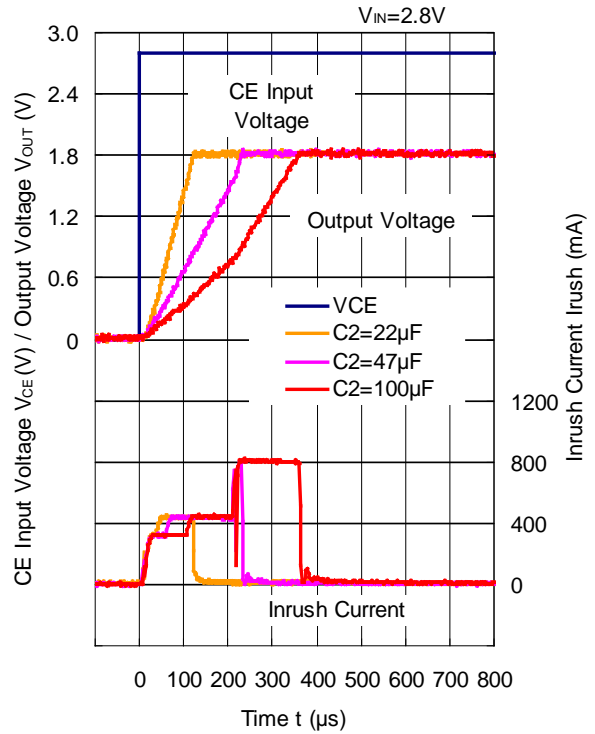

RP111x281x

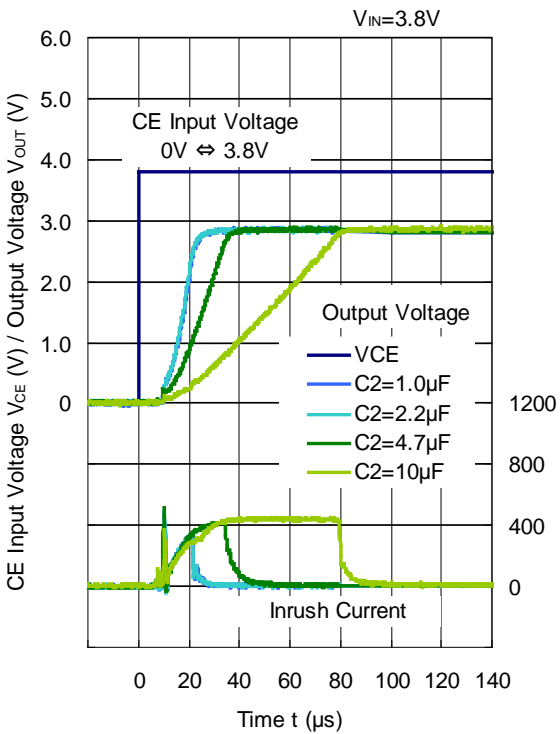

RP111x281x

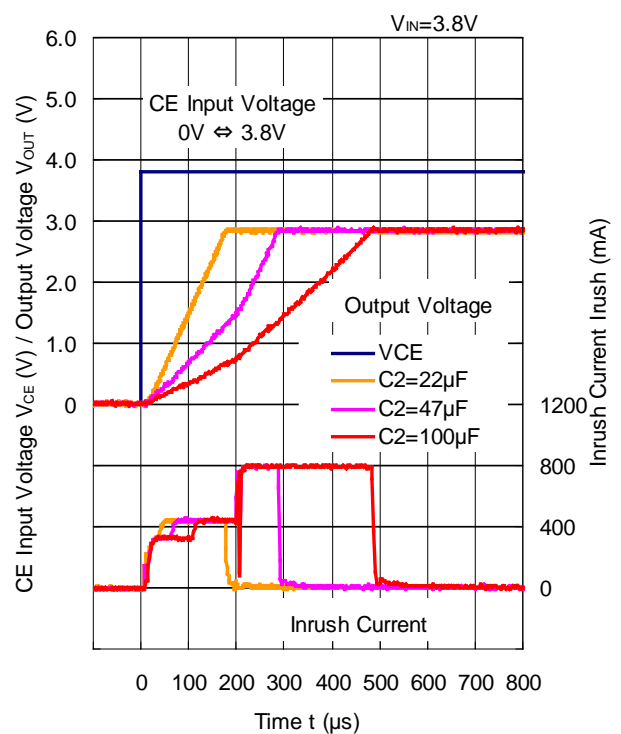

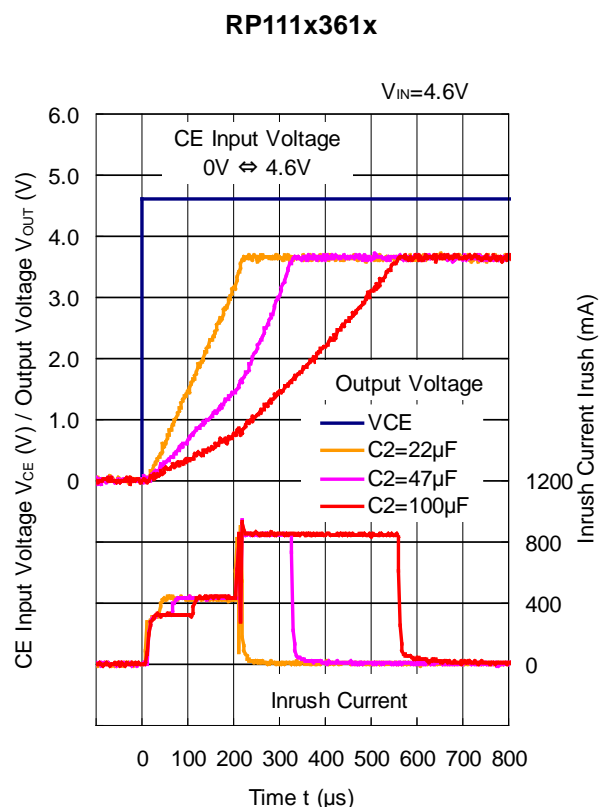
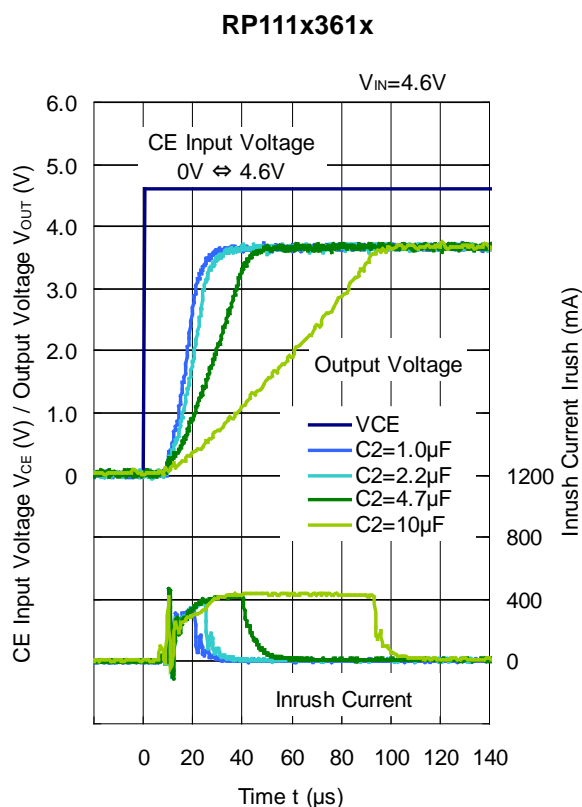

ESR vs. Output Current

When using these ICs, consider the following points: The relations between I_{OUT} (Output Current) and ESR of an output capacitor are shown below. The conditions when the white noise level is under $40\mu V$ (Avg.) are marked as the hatched area in the graph.

Measurement Conditions

Frequency Band : 10Hz to 2MHz
 Temperature : $-40^{\circ}C$ to $85^{\circ}C$
 $C1, C2$: $1.0\mu F$ or more

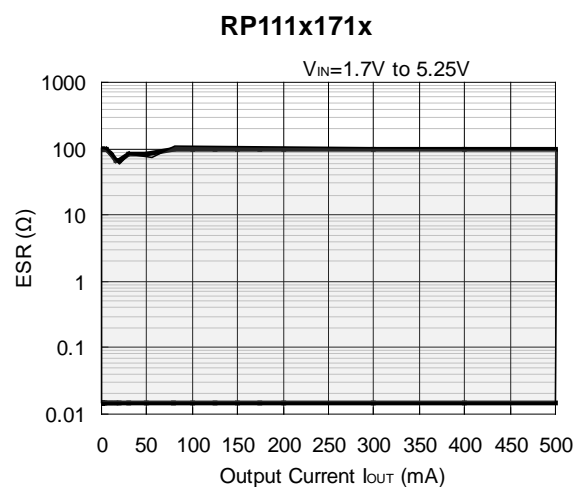
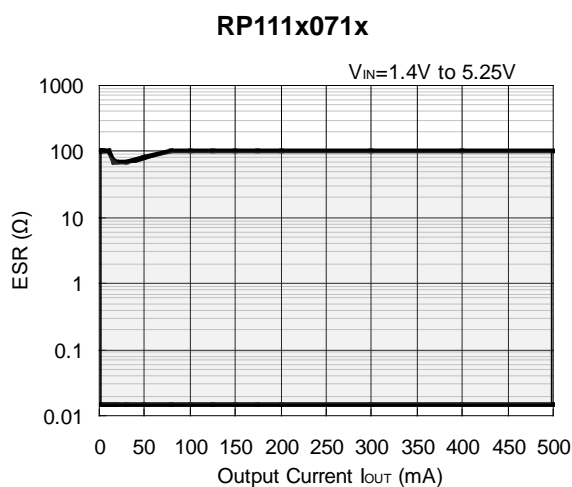

RP111xNO.EA-241-190523

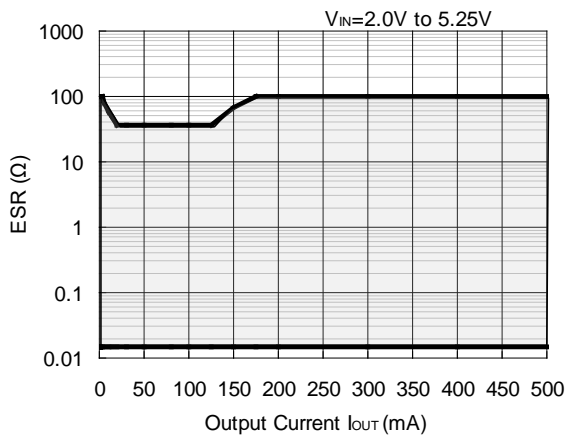
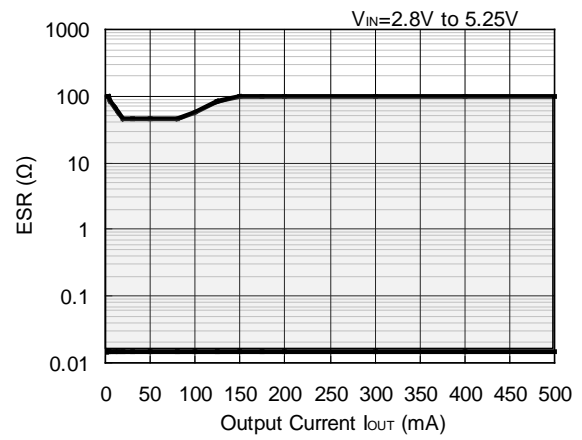
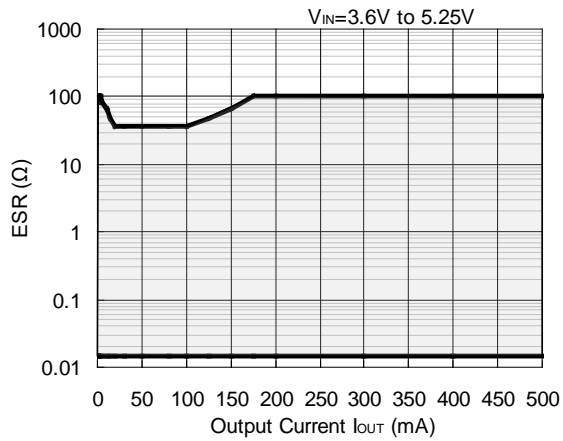
RP111x181x**RP111x281x****RP111x361x**



1. The products and the product specifications described in this document are subject to change or discontinuation of production without notice for reasons such as improvement. Therefore, before deciding to use the products, please refer to our sales representatives for the latest information thereon.
2. The materials in this document may not be copied or otherwise reproduced in whole or in part without prior written consent of our company.
3. Please be sure to take any necessary formalities under relevant laws or regulations before exporting or otherwise taking out of your country the products or the technical information described herein.
4. The technical information described in this document shows typical characteristics of and example application circuits for the products. The release of such information is not to be construed as a warranty of or a grant of license under our company's or any third party's intellectual property rights or any other rights.
5. The products listed in this document are intended and designed for use as general electronic components in standard applications (office equipment, telecommunication equipment, measuring instruments, consumer electronic products, amusement equipment etc.). Those customers intending to use a product in an application requiring extreme quality and reliability, for example, in a highly specific application where the failure or misoperation of the product could result in human injury or death (aircraft, spacevehicle, nuclear reactor control system, traffic control system, automotive and transportation equipment, combustion equipment, safety devices, life support system etc.) should first contact us.
6. We are making our continuous effort to improve the quality and reliability of our products, but semiconductor products are likely to fail with certain probability. In order to prevent any injury to persons or damages to property resulting from such failure, customers should be careful enough to incorporate safety measures in their design, such as redundancy feature, fire containment feature and fail-safe feature. We do not assume any liability or responsibility for any loss or damage arising from misuse or inappropriate use of the products.
7. Anti-radiation design is not implemented in the products described in this document.
8. The X-ray exposure can influence functions and characteristics of the products. Confirm the product functions and characteristics in the evaluation stage.
9. WLCSP products should be used in light shielded environments. The light exposure can influence functions and characteristics of the products under operation or storage.
10. There can be variation in the marking when different AOI (Automated Optical Inspection) equipment is used. In the case of recognizing the marking characteristic with AOI, please contact our sales or our distributor before attempting to use AOI.
11. Please contact our sales representatives should you have any questions or comments concerning the products or the technical information.



Nisshinbo Micro Devices Inc.

Official website

<https://www.nisshinbo-microdevices.co.jp/en/>

Purchase information

<https://www.nisshinbo-microdevices.co.jp/en/buy/>

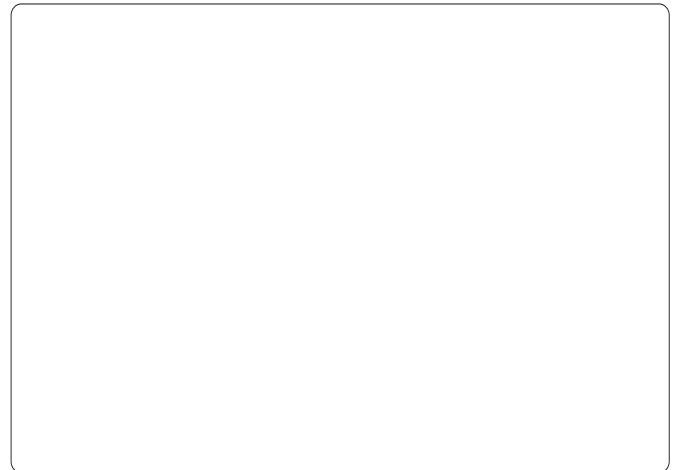

X-ON Electronics

Largest Supplier of Electrical and Electronic Components

Click to view similar products for [LDO Voltage Regulators](#) category:

Click to view products by [Nisshinbo](#) manufacturer:

Other Similar products are found below :

[AP7363-SP-13](#) [NCV8664CST33T3G](#) [L79M05TL-E](#) [AP7362-HA-7](#) [PT7M8202B12TA5EX](#) [TCR3DF185,LM\(CT](#) [TLF4949EJ](#)
[NCP4687DH15T1G](#) [NCV8703MX30TCG](#) [LP2951CN](#) [NCV4269CPD50R2G](#) [AP7315-25W5-7](#) [NCV47411PAAJR2G](#) [AP2111H-1.2TRG1](#)
[ZLDO1117QK50TC](#) [AZ1117ID-ADJTRG1](#) [NCV4263-2CPD50R2G](#) [NCP706ABMX300TAG](#) [NCP114BMX075TCG](#) [MC33269T-3.5G](#)
[TLE4471GXT](#) [AP7315-33SA-7](#) [NCV4266-2CST33T3G](#) [NCP715SQ15T2G](#) [NCV8623MN-50R2G](#) [NCV563SQ18T1G](#) [NCV8664CDT33RKG](#)
[NCV4299CD250R2G](#) [NCP715MX30TBG](#) [NCV8702MX25TCG](#) [TLE7270-2E](#) [NCV562SQ25T1G](#) [AP2213D-3.3TRG1](#) [AP2202K-2.6TRE1](#)
[NCV8170BMX300TCG](#) [NCV8152MX300180TCG](#) [NCP700CMT45TBG](#) [AP7315-33W5-7](#) [NCP154MX180300TAG](#) [AP2113AMTR-G1](#)
[NJW4104U2-33A-TE1](#) [MP2013AGG-5-P](#) [NCV8775CDT50RKG](#) [NJM2878F3-45-TE1](#) [S-19214B00A-V5T2U7](#) [S-19214B50A-V5T2U7](#) [S-](#)
[19213B50A-V5T2U7](#) [S-19214BC0A-E8T1U7*1](#) [S-19213B00A-V5T2U7](#) [S-19213B33A-V5T2U7](#)