200 mA LDO Regulator with Alternative Dual-Voltage Level Output

NO.EA-334-190610

OUTLINE

The RP155Z is a 200-mA LDO regulator with a selectable dual-voltage level output. It provides the VSEL pin that is used to select one of two preset output voltage levels.

Excellent ripple rejection, input transient response, and load transient response make the RP155Z ideal for the application for mobile communication equipment.

For protection, the RP155Z provides a short-current limiting circuit, a thermal shutdown circuit and an inrush current limiting circuit.

The RP155Z is offered in a 5-pin WLCSP-5-P1 package which achieves the smallest possible footprint solution on boards where area is limited.

FEATURES

- Input Voltage Range (Maximum Ratings)..... 1.9 V to 5.25 V (6.0 V)
- Supply Current..... Typ. 80 μ A
- Standby Current..... Typ. 0.1 μ A
- Dropout Voltage Typ. 0.085 V, $I_{OUT} = 200$ mA, $V_{SET} = 2.5$ V
- Ripple Rejection..... Typ. 75 dB, $f = 1$ kHz,
Typ. 70 dB, $f = 10$ kHz
- Output Voltage Accuracy..... $\pm 1.0\%$
- Output Voltage Temperature Coefficient Typ. ± 30 ppm/ $^{\circ}$ C
- Output Voltage Range 1.6 V to 3.6 V
- Line Regulation..... Typ. 0.02%/V
- Short-current Limiting Typ. 50 mA
- Overcurrent Protection Fold-back Type
- Thermal Shutdown Typ. 165 $^{\circ}$ C
- Inrush Current Limiting Typ. 160 mA during 180 μ s after start-up
- Ceramic Capacitor Compatible..... 1.0 μ F or more
- Package..... WLCSP-5-P1, 1.346 mm x 0.98 mm

APPLICATIONS

- Printers and PCs with SD Card Slots
- Battery-powered Equipment: Portable Music Players, IC Recorders, Cameras and Camcorders
- Portable Communication Equipment: Smartphones, Feature Phones
- Electronic Equipment System that Requires Two Levels of Output Voltage Regulation in Normal Mode/Power-Saving Mode

RP155Z

NO.EA-334-190610

SELECTION GUIDE

The set output voltage, the package type and the auto discharge function⁽¹⁾ are user-selectable options.

Selection Guide

Product Name	Package	Quantity per Reel	Pb Free	Halogen Free
RP155Zxxx*-E2-F	WLCSP-5-P1	5,000 pcs	Yes	Yes

xxx: Specify a combination of two set output voltages (V_{SET1}/V_{SET2}).

V_{SET1}/V_{SET2} can be selected within the range of 1.6 V to 3.6 V.

*: Specify the auto-discharge option.

B: Auto discharge function included

BLOCK DIAGRAM

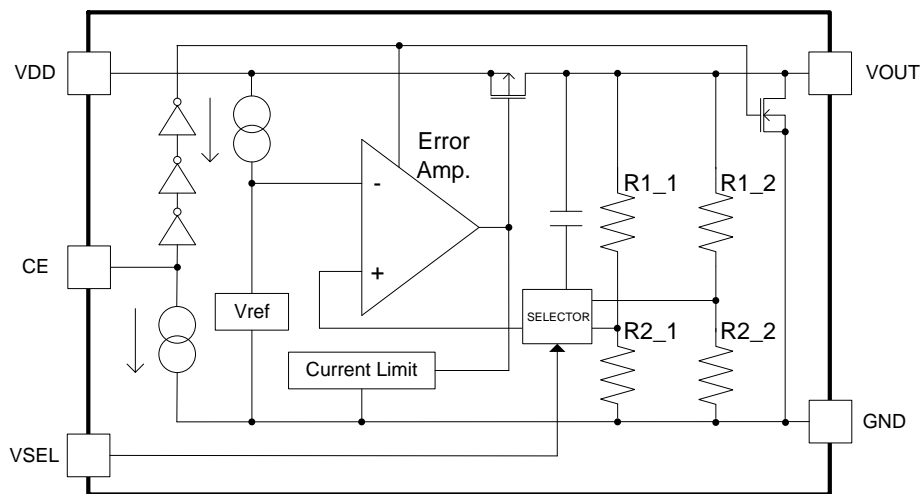

RP155Z Block Diagram

⁽¹⁾ Auto-discharge function quickly lowers the output voltage to 0 V, when the chip enable signal is switched from the active mode to the standby mode, by releasing the electrical charge accumulated in the external capacitor.

PIN DESCRIPTIONS

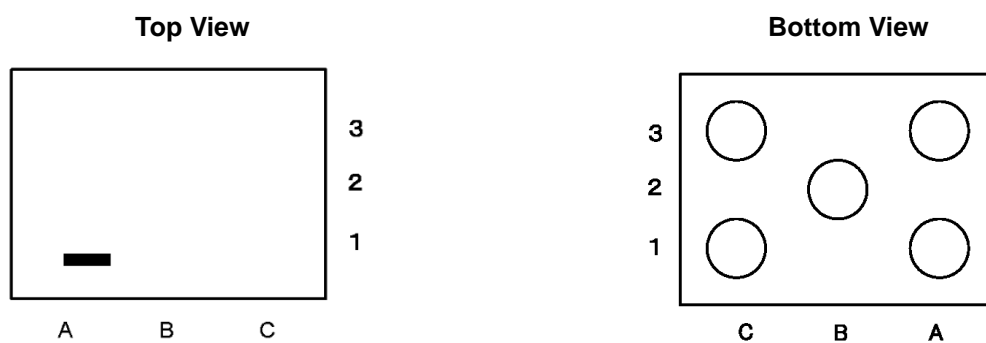

WLCSP-5-P1 Pin Configurations

WLCSP-5-P1 Pin Descriptions

Pin No.	Symbol	Description
A1	CE	Chip Enable Pin, Active-high
A3	VSEL	Output Voltage Selector Pin, V_{SET1} -low, V_{SET2} -high
B2	GND	Ground Pin
C1	VOUT	Output Pin
C3	VDD	Input Pin

RP155Z

NO.EA-334-190610

ABSOLUTE MAXIMUM RATINGS

Absolute Maximum Ratings

Symbol	Item	Rating	Unit
V_{IN}	Input Voltage	-0.3 to 6.0	V
V_{CE}	CE Pin Input Voltage	-0.3 to 6.0	V
V_{SEL}	VSEL Pin Input Voltage	-0.3 to 6.0	V
V_{OUT}	VOUT Pin Output Voltage	-0.3 to $V_{IN}+0.3$	V
I_{OUT}	Output Current	510	mA
P_D	Power Dissipation (JEDEC STD.51) ⁽¹⁾	550	mW
T_j	Junction Temperature	-40 to 125	°C
T_{stg}	Storage Temperature	-55 to 125	°C

ABSOLUTE MAXIMUM RATINGS

Electronic and mechanical stress momentarily exceeded absolute maximum ratings may cause permanent damage and may degrade the life time and safety for both device and system using the device in the field. The functional operation at or over these absolute maximum ratings is not assured.

RECOMMENDED OPERATING CONDITIONS

Recommended Operating Conditions

Symbol	Item	Rating	Unit
V_{IN}	Input Voltage ⁽²⁾	1.9 to 5.25	V
T_a	Operating Temperature	-40 to 85	°C

RECOMMENDED OPERATING CONDITIONS

All of electronic equipment should be designed that the mounted semiconductor devices operate within the recommended operating conditions. The semiconductor devices cannot operate normally over the recommended operating conditions, even if they are used over such conditions by momentary electronic noise or surge. And the semiconductor devices may receive serious damage when they continue to operate over the recommended operating conditions.

⁽¹⁾ Refer to *POWER DISSIPATION* for detailed information.

⁽²⁾ In case of operating the device beyond 5.25 V, do not exceed 5.5 V with 500 total operating hours.

ELECTRICAL CHARACTERISTICS

$V_{IN} = V_{SET} + 1.0 \text{ V}$, $I_{OUT} = 1 \text{ mA}$, $C_{IN} = C_{OUT} = 1.0 \mu\text{F}$, $V_{SEL} = \text{low/ high}$, unless otherwise noted.

The specifications surrounded by are guaranteed by design engineering at $-40^\circ\text{C} \leq T_a \leq 85^\circ\text{C}$.

RP155Z Electrical Characteristics

($T_a = 25^\circ\text{C}$)

Symbol	Item	Conditions	Min.	Typ.	Max.	Unit
V_{OUT}	Output Voltage	$T_a = 25^\circ\text{C}$	x0.990		x1.010	V
		$-40^\circ\text{C} \leq T_a \leq 85^\circ\text{C}$	x0.985		x1.015	V
I_{OUT}	Output Current		200			mA
$\frac{\Delta V_{OUT}}{\Delta I_{OUT}}$	Load Regulation	$1 \text{ mA} \leq I_{OUT} \leq 200 \text{ mA}$		1	10	mV
V_{DIF}	Dropout Voltage	$I_{OUT} = 200 \text{ mA}$	Refer to <i>Product-specific Electrical Characteristics</i>			
I_{SS}	Supply Current	$I_{OUT} = 0 \text{ mA}$		80	125	μA
$I_{standby}$	Standby Current	$V_{CE} = 0 \text{ V}$		0.1	1.0	μA
$\frac{\Delta V_{OUT}}{\Delta V_{IN}}$	Line Regulation	$V_{SET} + 0.5 \text{ V} \leq V_{IN} \leq 5.25 \text{ V}$		0.02	0.10	%/V
RR	Ripple Rejection	$f = 1 \text{ kHz}$, Ripple 0.2 Vp-p, $V_{IN} = V_{SET} + 1.0 \text{ V}$, $I_{OUT} = 30 \text{ mA}$ ($V_{OUT} \leq 2.0 \text{ V}$, $V_{IN} = 3.0 \text{ V}$)		75		dB
$\frac{\Delta V_{OUT}}{\Delta T_a}$	Output Voltage Temperature Coefficient	$-40^\circ\text{C} \leq T_a \leq 85^\circ\text{C}$		± 30		ppm/ $^\circ\text{C}$
I_{SC}	Short Current Limit	$V_{OUT} = 0 \text{ V}$		50		mA
I_{PD}	CE Pull-down Current			0.3	0.6	μA
V_{CEH}	CE Input Voltage "H"		1.0			V
V_{CEL}	CE Input Voltage "L"				0.4	V
V_{VSELH}	VSEL Input Voltage "H"		1.0			V
V_{VSELL}	VSEL Input Voltage "L"				0.4	V
T_{TSD}	Thermal Shutdown Temperature	Junction Temperature		165		$^\circ\text{C}$
T_{TSR}	Thermal Shutdown Released Temperature	Junction Temperature		100		$^\circ\text{C}$
en	Output Noise	BW = 10 Hz to 100 kHz		$17 \times V_{SET} + 8$		μVrms
R_{LOW}	Low Output Nch Tr. ON Resistance	$V_{IN} = 4.0 \text{ V}$, $V_{CE} = 0 \text{ V}$		60		Ω

All test items listed under *ELECTRICAL CHARACTERISTICS* are done under the pulse load condition ($T_j \approx T_a = 25^\circ\text{C}$) except Output Voltage Temperature Coefficient, Output Noise and Ripple Rejection.

RP155Z

NO.EA-334-190610

ELECTRICAL CHARACTERISTICS (continued) $V_{IN} = V_{SET} + 1.0 \text{ V}$, $I_{OUT} = 1 \text{ mA}$, $C_{IN} = C_{OUT} = 1.0 \mu\text{F}$, $V_{SEL} = \text{low/high}$, unless otherwise noted.The specifications surrounded by are guaranteed by design engineering at $-40^\circ\text{C} \leq T_a \leq 85^\circ\text{C}$.**RP155Z Product-specific Electrical Characteristics**

(Ta = 25°C)

Product Name	V _{SET1} / V _{SET2}	V _{OUT} [V]						V _{DIF} [V]	
		Ta = 25°C			-40°C ≤ Ta ≤ 85°C			Typ.	Max.
		Min.	Typ.	Max.	Min.	Typ.	Max.		
RP155Z001B	V _{SET1}	1.782	1.800	1.818	1.773	1.800	1.827	0.100	0.138
	V _{SET2}	2.822	2.850	2.878	2.808	2.850	2.892	0.085	0.117
RP155Z003B	V _{SET1}	1.584	1.600	1.616	1.576	1.600	1.624	-(1)	-1
	V _{SET2}	3.564	3.600	3.636	3.546	3.600	3.654	0.071	0.105
RP155Z004B	V _{SET1}	1.782	1.800	1.818	1.773	1.800	1.827	0.100	0.138
	V _{SET2}	3.267	3.300	3.333	3.251	3.300	3.349	0.071	0.105
RP155Z005B	V _{SET1}	3.267	3.300	3.333	3.251	3.300	3.349	0.071	0.105
	V _{SET2}	1.782	1.800	1.818	1.773	1.800	1.827	0.100	0.138
RP155Z006B	V _{SET1}	2.871	2.900	2.929	2.857	2.900	2.943	0.085	0.117
	V _{SET2}	1.782	1.800	1.818	1.773	1.800	1.827	0.100	0.138

⁽¹⁾ The input voltage should be equal or more than the minimum operating voltage (1.9 V).

TYPICAL APPLICATION

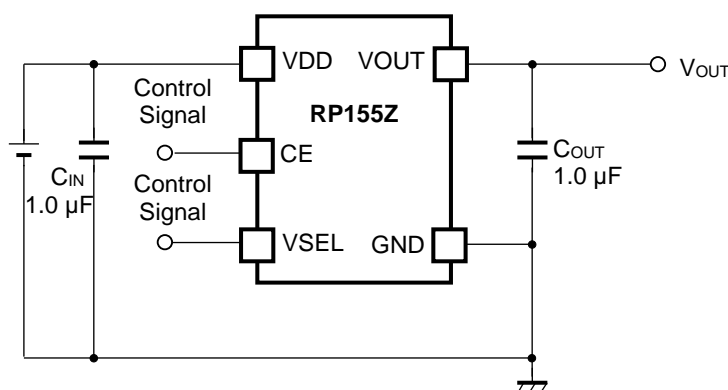

RP155Z Typical Application Circuit

Technical Notes on the External Components

- Ensure the VDD and GND lines are sufficiently robust. If their impedances are too high, noise pickup or unstable operation may result. Connect a 1.0 μF or more input capacitor (C_{IN}) between the VDD and GND pins with shortest-distance wiring. Using ceramic capacitors (voltage rating of 6.3 V or more) with small Equivalent Series Resistance (ESR), Equivalent Series Inductance (ESL) and temperature dependence, such as X7R and X5R are recommended.
- In this device, phase compensation is provided to secure stable operation even when the load current is varied. For this purpose, connect a 1.0 μF or more output capacitor (C_{OUT}) between the VOUT and GND pins with shortest-distance wiring. In addition, as capacitance of a ceramic capacitor depends on temperature, DC bias and a package size, select capacitors with attention to influence by them bearing in mind the effective capacitance indicated below.

Set Output Voltage (V_{SET})	Effective Capacitance
$1.6 \text{ V} \leq V_{\text{SET}} < 2.1 \text{ V}$	0.75 μF or more
$2.1 \text{ V} \leq V_{\text{SET}} < 2.6 \text{ V}$	0.70 μF or more
$2.6 \text{ V} \leq V_{\text{SET}} < 3.2 \text{ V}$	0.65 μF or more
$3.2 \text{ V} \leq V_{\text{SET}} \leq 3.6 \text{ V}$	0.60 μF or more

Using tantalum capacitors with large ESR may cause unstable output. Fully evaluate characteristics including frequency to ensure stable output.

TYPICAL CHARACTERISTICS

Note: Typical Characteristics are intended to be used as reference data, they are not guaranteed.

1) Output Voltage vs. Output Current (C_{IN} = Ceramic 1.0 μ F, C_{OUT} = Ceramic 1.0 μ F, T_a = 25°C)
 1.6 V (V_{SET1}/V_{SET2}) 1.8 V (V_{SET1}/V_{SET2})

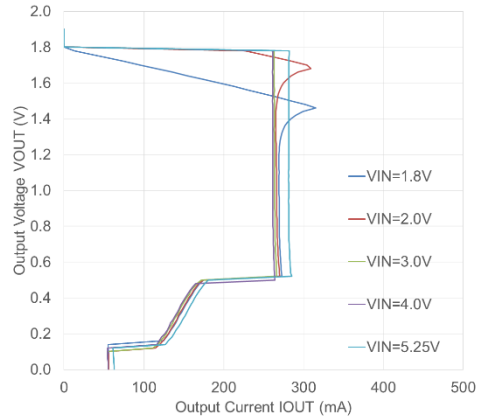
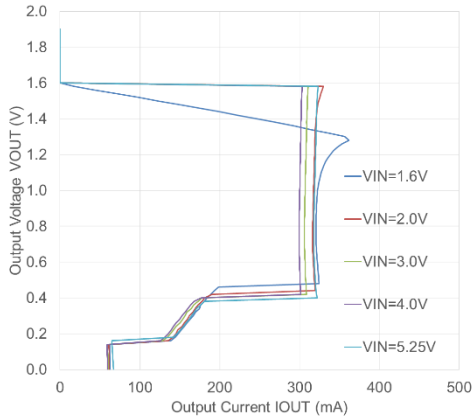

2.85 V (V_{SET1}/V_{SET2})

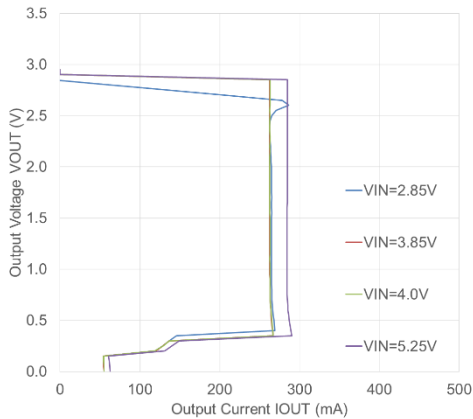

3.6 V (V_{SET1}/V_{SET2})

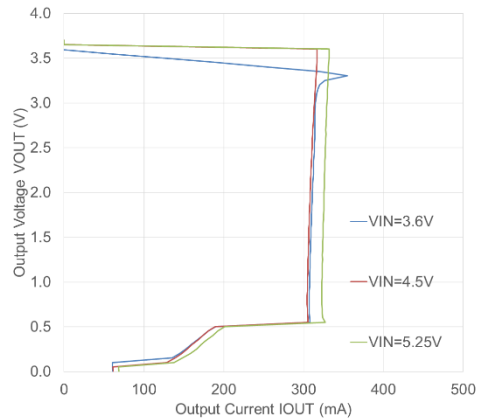

2) Output Voltage vs. Input Voltage (C_{IN} = Ceramic 1.0 μ F, C_{OUT} = Ceramic 1.0 μ F, T_a = 25°C)
 1.6 V (V_{SET1}/V_{SET2}) 1.8 V (V_{SET1}/V_{SET2})

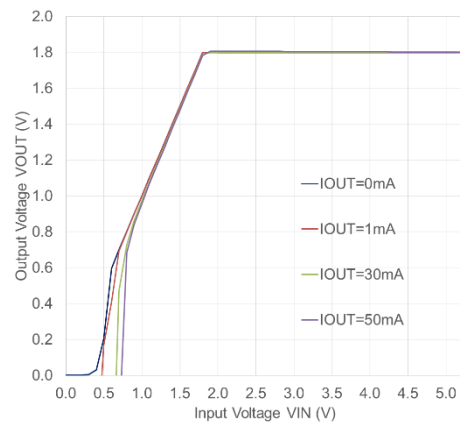
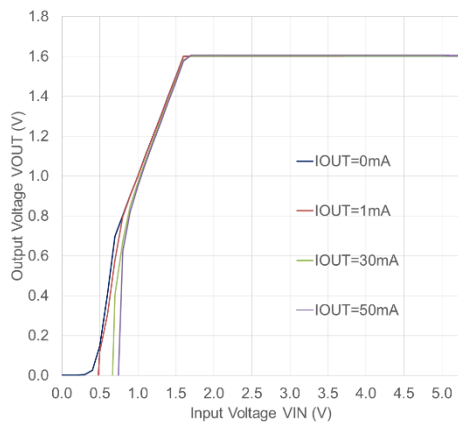

2.85 V (V_{SET1}/V_{SET2})

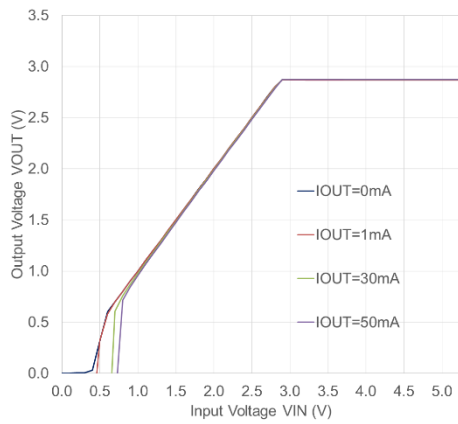

3.6 V (V_{SET1}/V_{SET2})

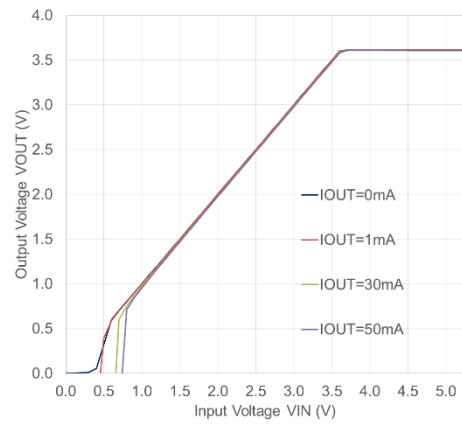

3) Supply Current vs. Input Voltage ($C_{IN} = \text{Ceramic } 1.0 \mu\text{F}$, $C_{OUT} = \text{Ceramic } 1.0 \mu\text{F}$, $T_a = 25^\circ\text{C}$)

1.6 V (V_{SET1}/V_{SET2})

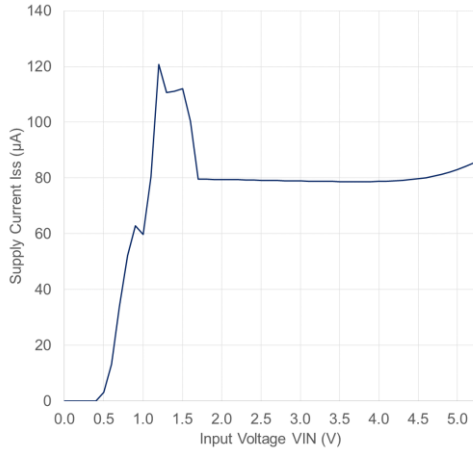

1.8 V (V_{SET1}/V_{SET2})

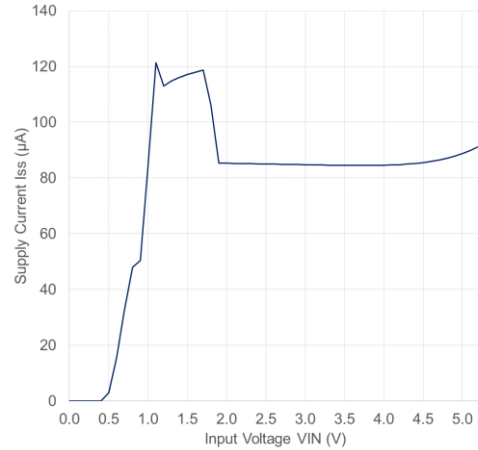

2.85 V (V_{SET1}/V_{SET2})

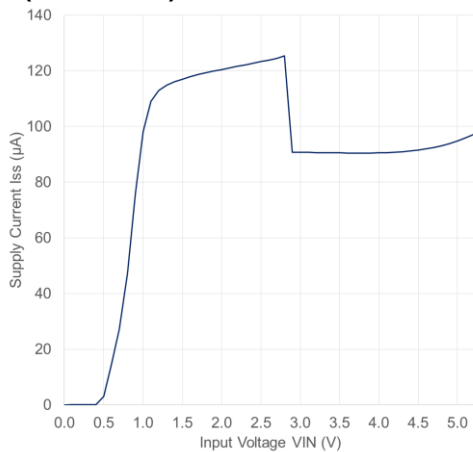

3.6 V (V_{SET1}/V_{SET2})

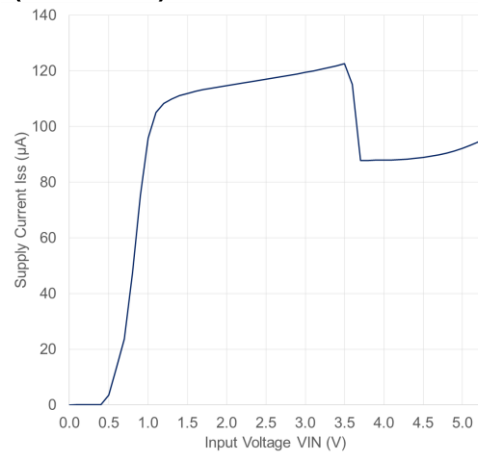

4) Output Voltage vs. Temperature (C_{IN} = Ceramic 1.0 μ F, C_{OUT} = Ceramic 1.0 μ F)

1.6 V (V_{SET1}/V_{SET2})

$V_{IN} = 2.6$ V, $I_{OUT} = 1$ mA

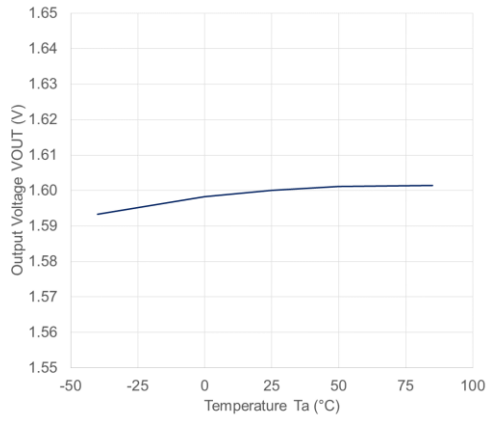

1.8 V (V_{SET1}/V_{SET2})

$V_{IN} = 2.8$ V, $I_{OUT} = 1$ mA

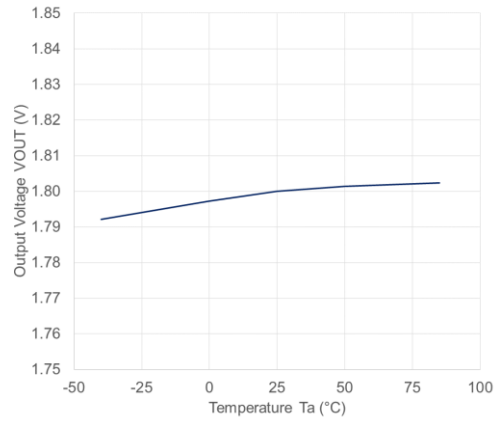

2.85 V (V_{SET1}/V_{SET2})

$V_{IN} = 3.85$ V, $I_{OUT} = 1$ mA

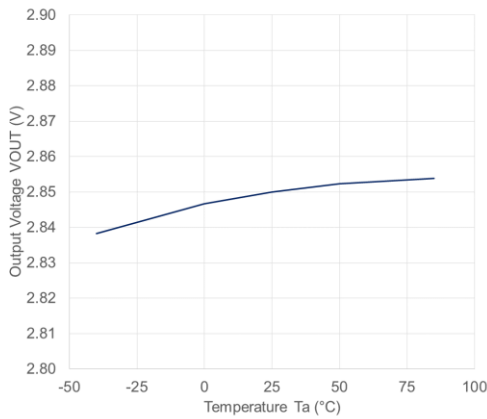

3.6 V (V_{SET1}/V_{SET2})

$V_{IN} = 4.6$ V, $I_{OUT} = 1$ mA

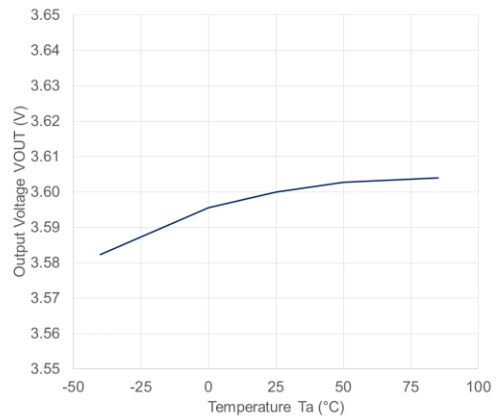

5) Supply Current vs. Temperature

1.6 V (V_{SET1}/V_{SET2})

$V_{IN} = 2.6$ V, $I_{OUT} = 0$ mA

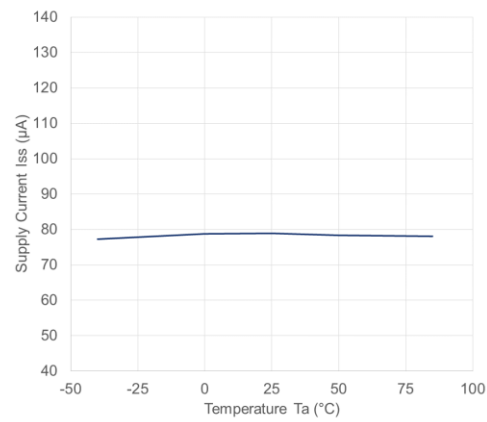

1.8 V (V_{SET1}/V_{SET2})

$V_{IN} = 2.8$ V, $I_{OUT} = 0$ mA

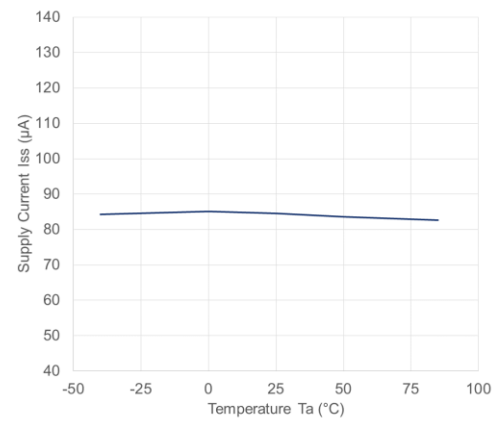

2.85 V (V_{SET1}/V_{SET2})
 $V_{IN} = 3.85\text{ V}, I_{OUT} = 0\text{ mA}$

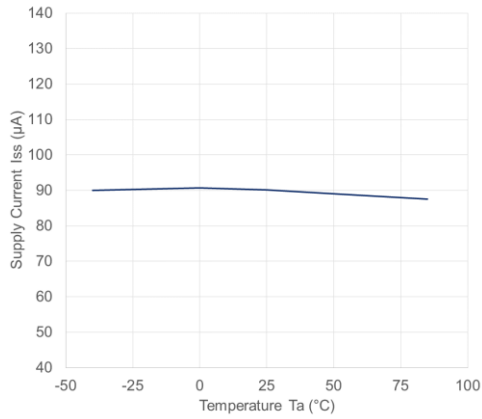

3.6 V (V_{SET1}/V_{SET2})
 $V_{IN} = 4.6\text{ V}, I_{OUT} = 0\text{ mA}$

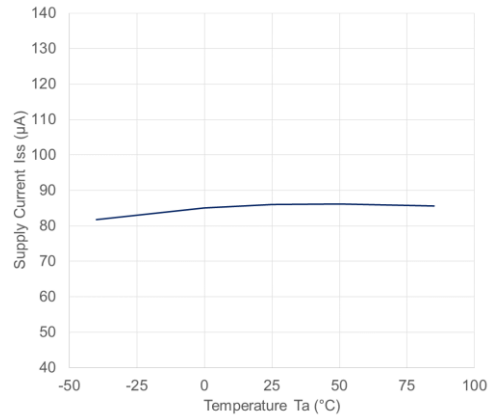

6) Dropout Voltage vs. Output Current ($C_{IN} = \text{Ceramic } 1.0\ \mu\text{F}, C_{OUT} = \text{Ceramic } 1.0\ \mu\text{F}$)

1.6 V (V_{SET1}/V_{SET2})

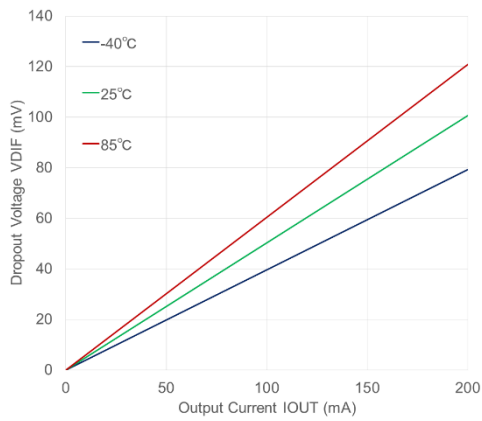

1.8 V (V_{SET1}/V_{SET2})

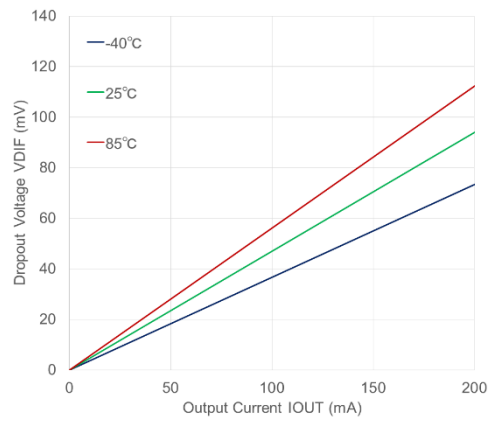

2.85 V (V_{SET1}/V_{SET2})

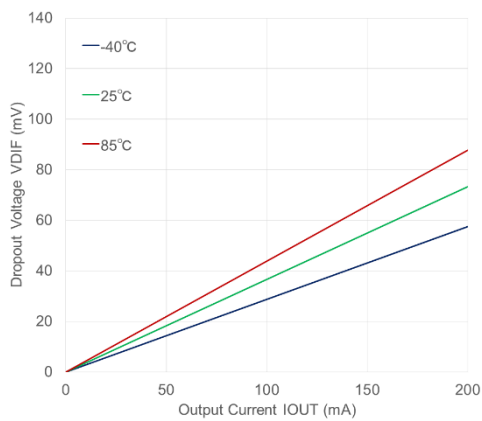

3.6 V (V_{SET1}/V_{SET2})

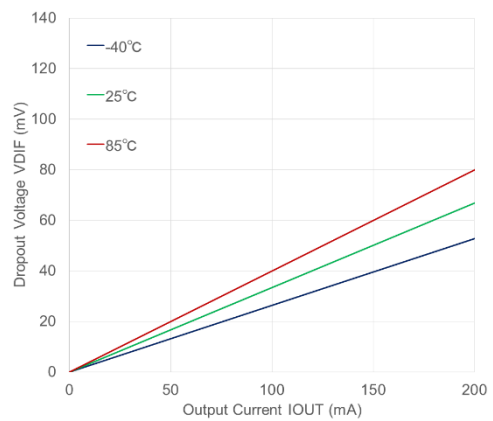

7) Dropout Voltage vs. V_{R_VSET} ($C_{IN} = \text{Ceramic } 1.0 \mu\text{F}$, $C_{OUT} = \text{Ceramic } 1.0 \mu\text{F}$, $T_a = 25^\circ\text{C}$)
 V_{SET1}/V_{SET2}

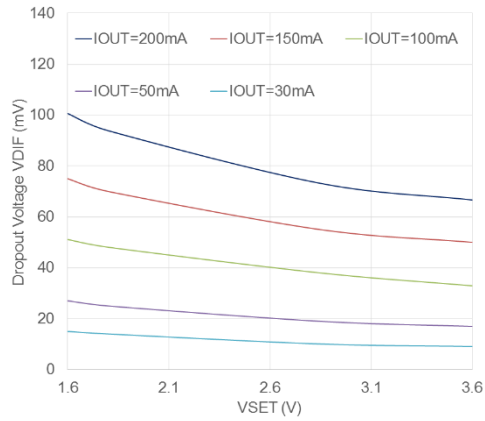

8) Dropout Voltage vs. Temperature ($C_{IN} = \text{Ceramic } 1.0 \mu\text{F}$, $C_{OUT} = \text{Ceramic } 1.0 \mu\text{F}$)
1.6 V (V_{SET1}/V_{SET2}) **1.8 V (V_{SET1}/V_{SET2})**

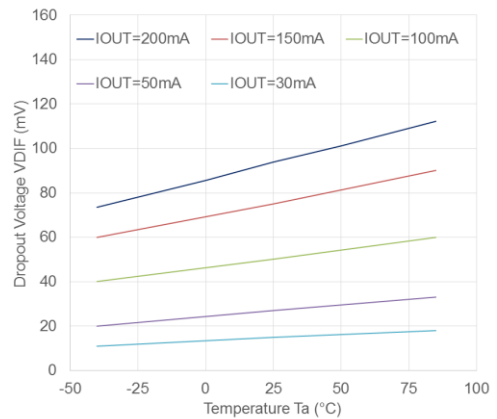
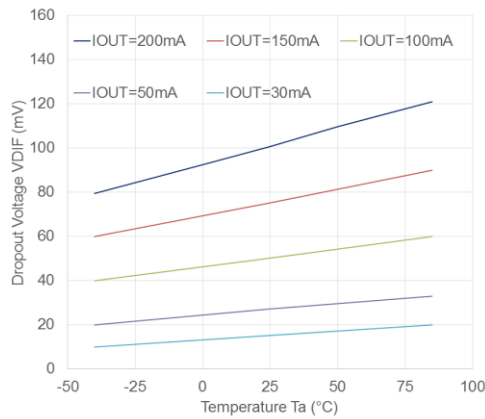

2.85 V (V_{SET1}/V_{SET2})

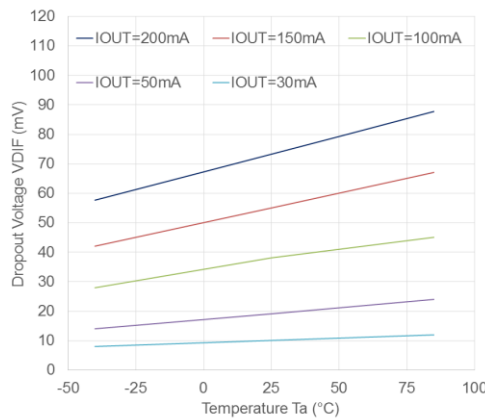

3.6 V (V_{SET1}/V_{SET2})

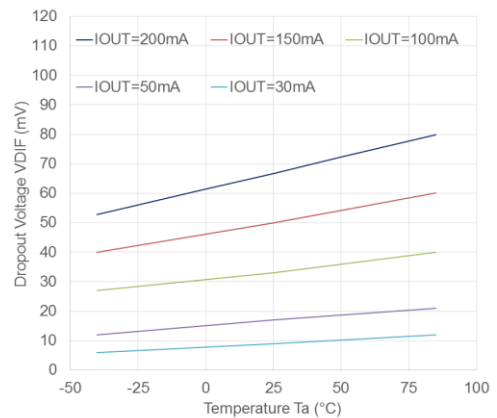

9) Ripple Rejection vs. Input Bias (C_{IN} = none, C_{OUT} = Ceramic 1.0 μ F, Input Ripple = 0.2 Vp-p, T_a = 25°C)
1.6 V (V_{SET1}/V_{SET2})

$I_{OUT} = 1$ mA

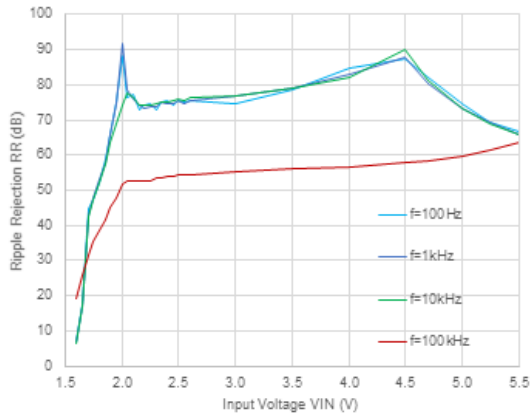

$I_{OUT} = 30$ mA

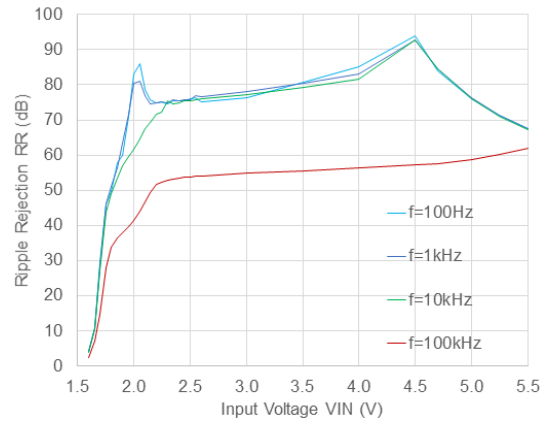

1.8 V (V_{SET1}/V_{SET2})

$I_{OUT} = 1$ mA

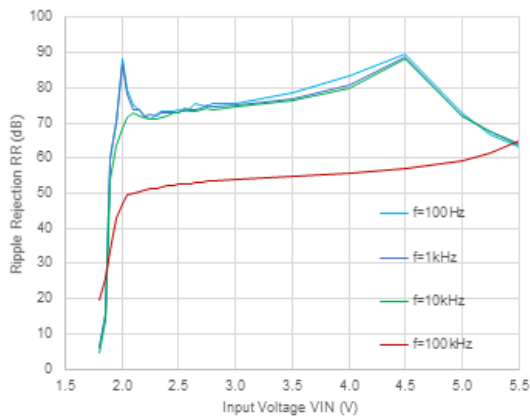

$I_{OUT} = 30$ mA

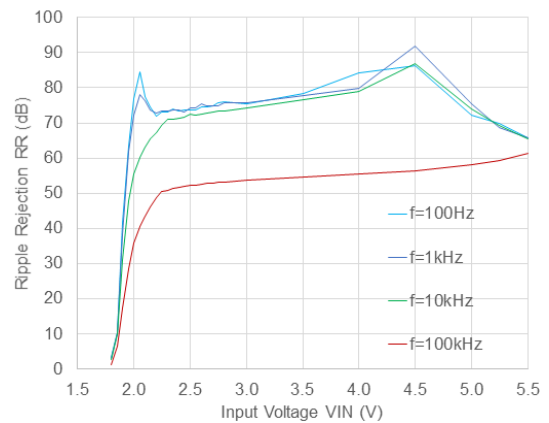

2.85 V (V_{SET1}/V_{SET2})

$I_{OUT} = 1$ mA

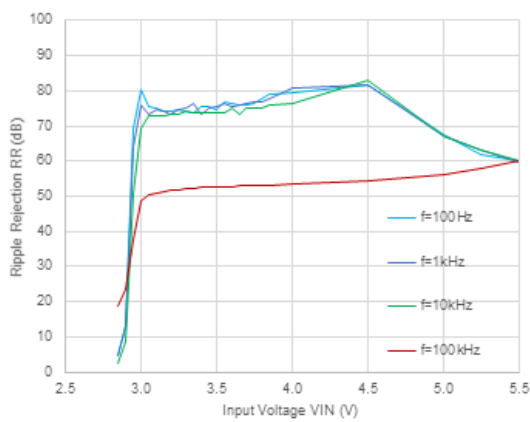

$I_{OUT} = 30$ mA

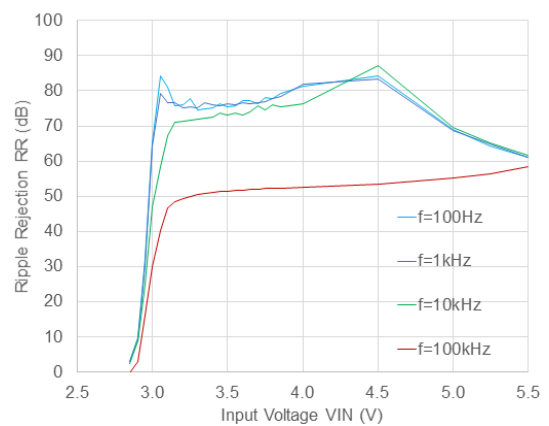

RP155Z

NO.EA-334-190610

3.6 V (V_{SET1}/V_{SET2})
 $I_{OUT} = 1\text{ mA}$

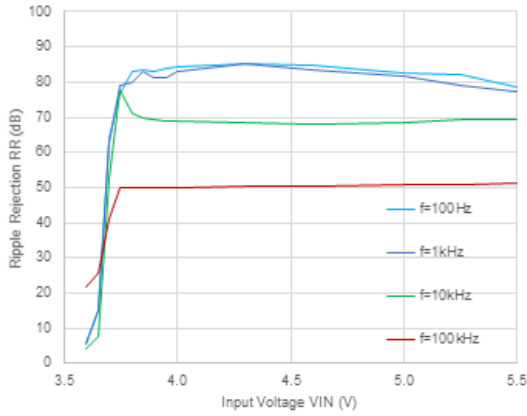

$I_{OUT} = 30\text{ mA}$

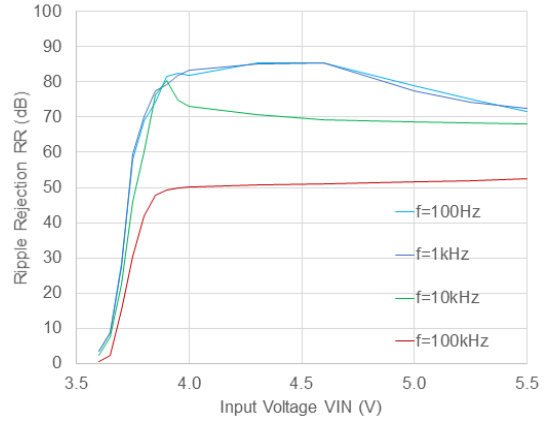

10) Ripple Rejection vs. Frequency ($C_{IN} = \text{none}$, $C_{OUT} = \text{Ceramic } 1.0\ \mu\text{F}$, Input Ripple = 0.2 Vp-p , $T_a = 25^\circ\text{C}$)

1.6 V (V_{SET1}/V_{SET2}), $V_{IN} = 2.6\text{ V}$

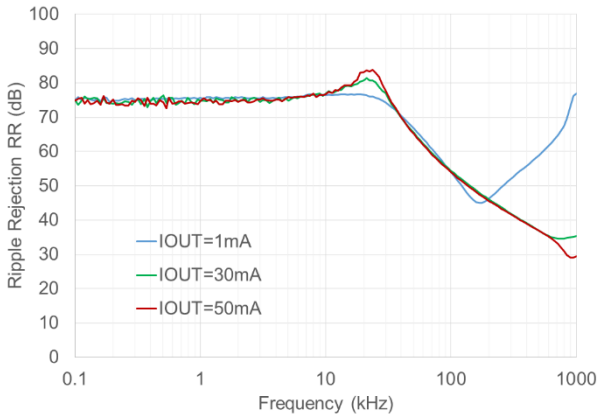

1.8 V (V_{SET1}/V_{SET2}), $V_{IN} = 2.8\text{ V}$

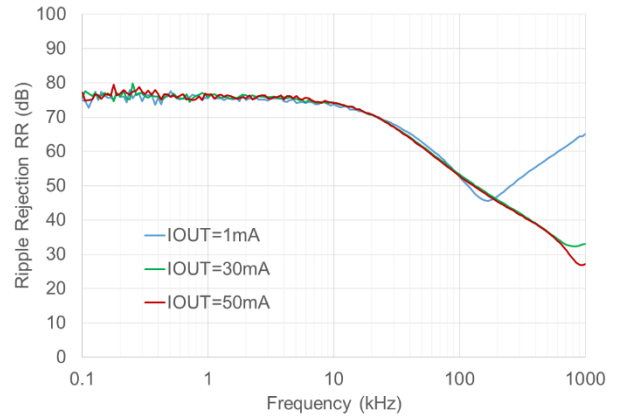

2.85 V (V_{SET1}/V_{SET2}), $V_{IN} = 3.85\text{ V}$

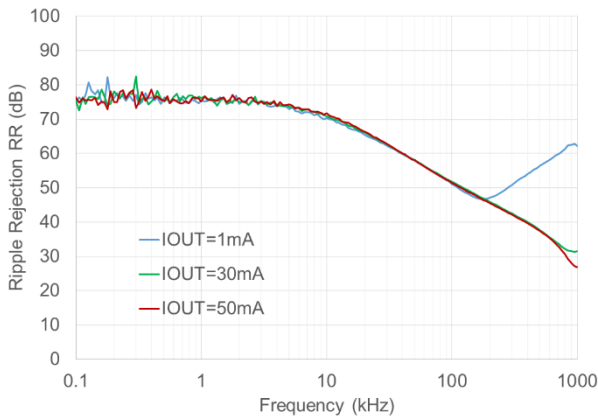

3.6 V (V_{SET1}/V_{SET2}), $V_{IN} = 4.6\text{ V}$

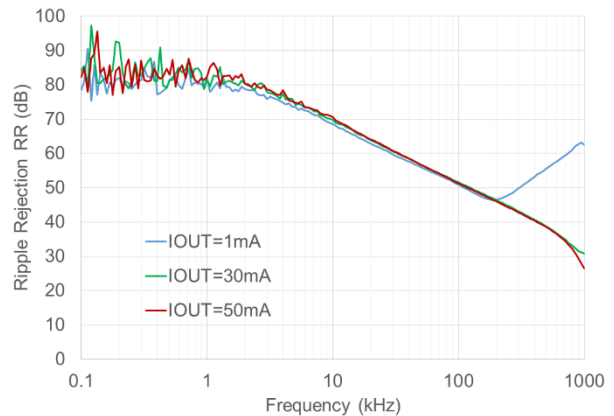

11) Input Transient Response (C_{IN} = none, C_{OUT} = Ceramic 1.0 μ F, I_{OUT} = 30 mA, $t_r = t_f = 5 \mu$ s, $T_a = 25^\circ$ C)

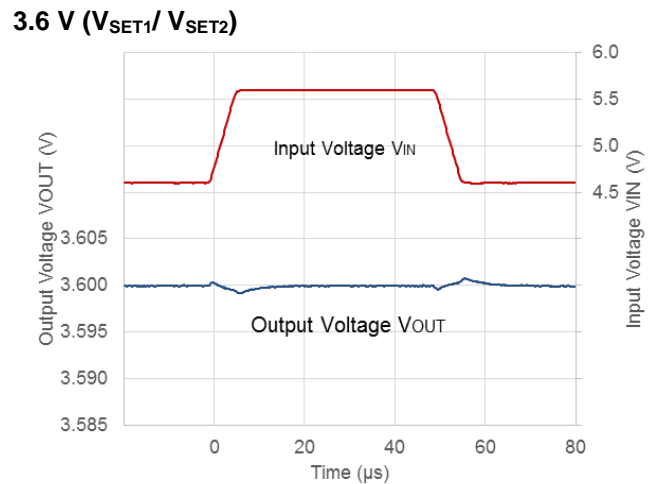
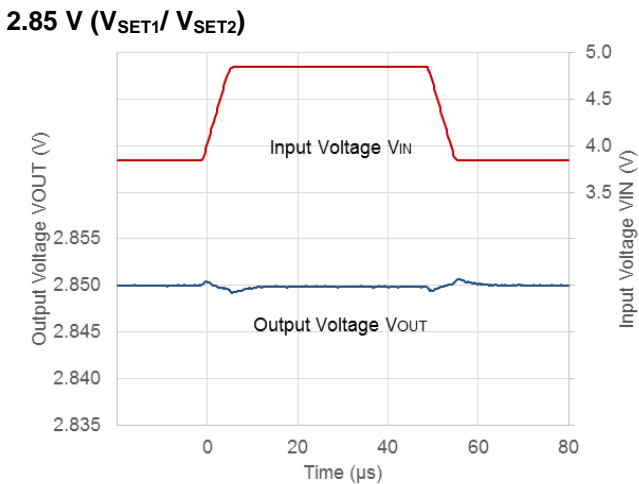
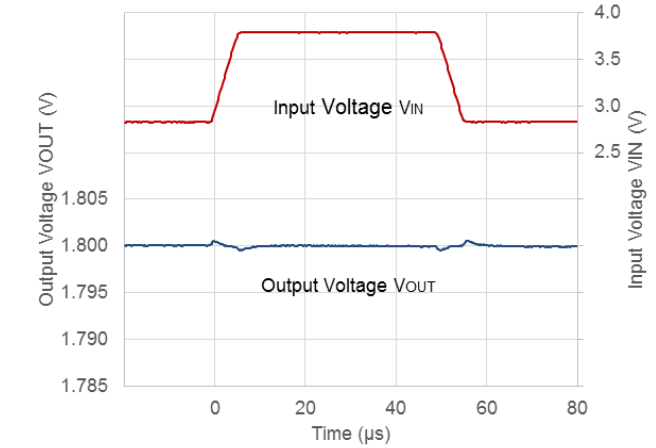
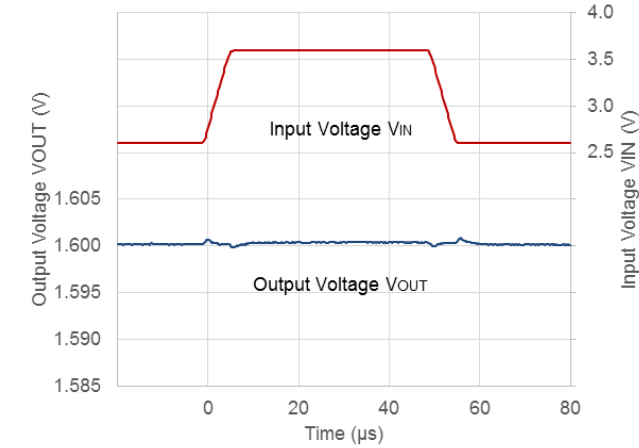

12) Load Transient Response (C_{IN} = Ceramic 1.0 μ F, C_{OUT} = Ceramic 1.0 μ F, $t_r = t_f = 0.5 \mu$ s, $T_a = 25^\circ$ C)

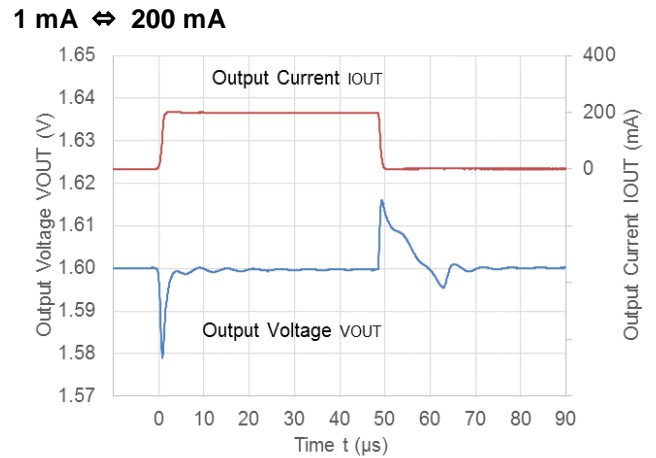
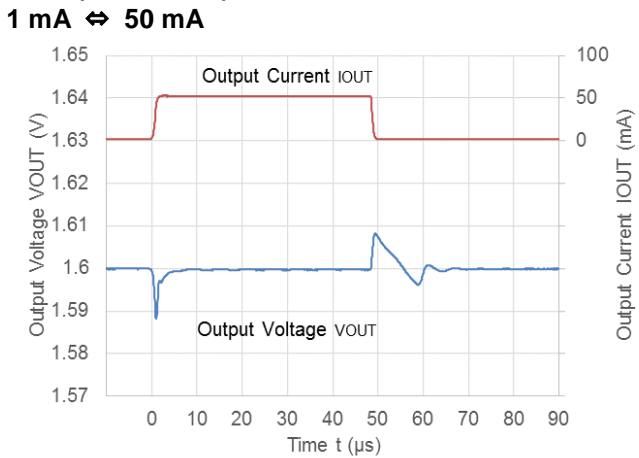

RP155Z

NO.EA-334-190610

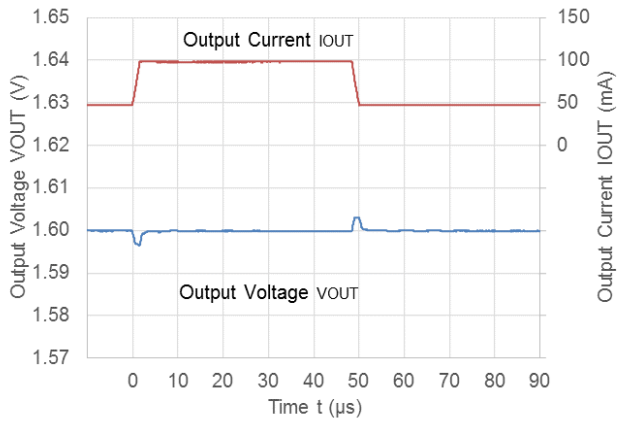
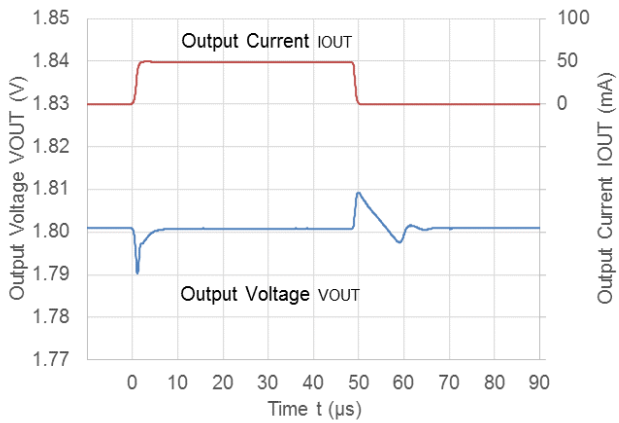
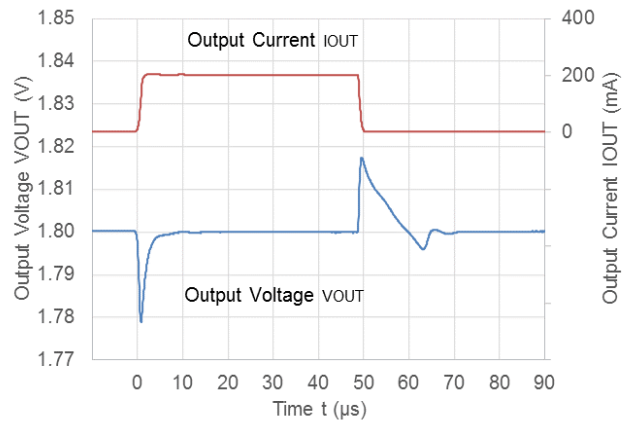
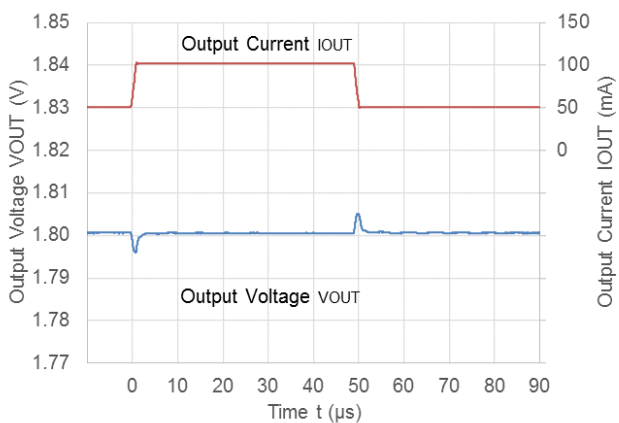
50 mA \leftrightarrow 200 mA**1.8 V ($V_{\text{SET1}}/V_{\text{SET2}}$), $V_{\text{IN}} = 2.8 \text{ V}$** **1 mA \leftrightarrow 50 mA****1 mA \leftrightarrow 200 mA****50 mA \leftrightarrow 200 mA**

2.85 V (V_{SET1}/V_{SET2}), $V_{IN} = 3.85$ V
1 mA \leftrightarrow 50 mA

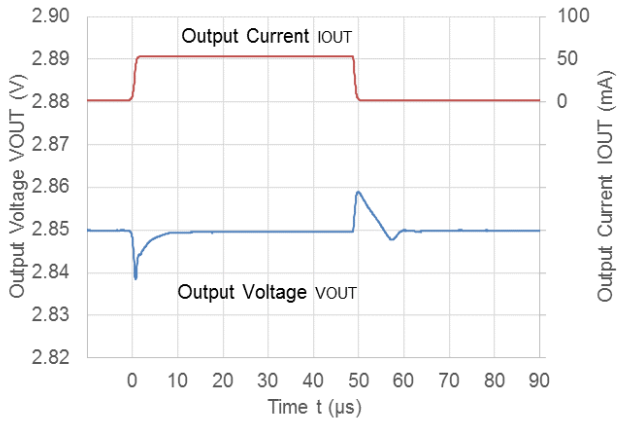

1 mA \leftrightarrow 200 mA

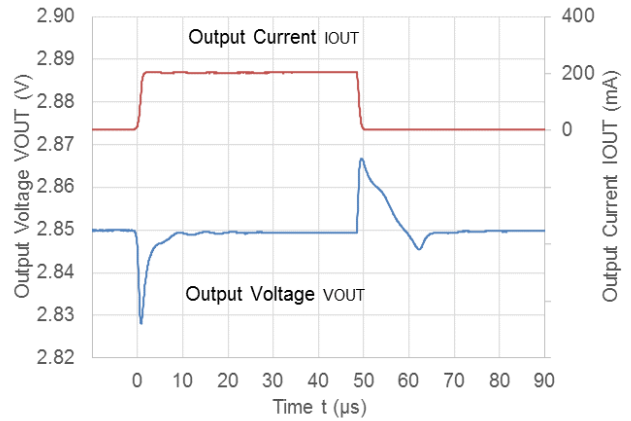

50 mA \leftrightarrow 200 mA

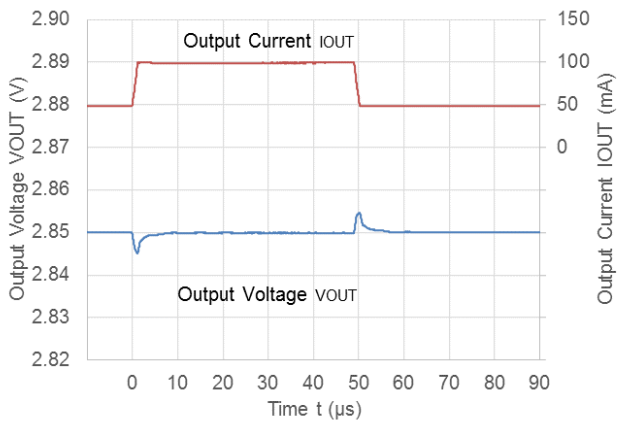

3.6 V (V_{SET1}/V_{SET2}), $V_{IN} = 4.6$ V
1 mA \leftrightarrow 50 mA

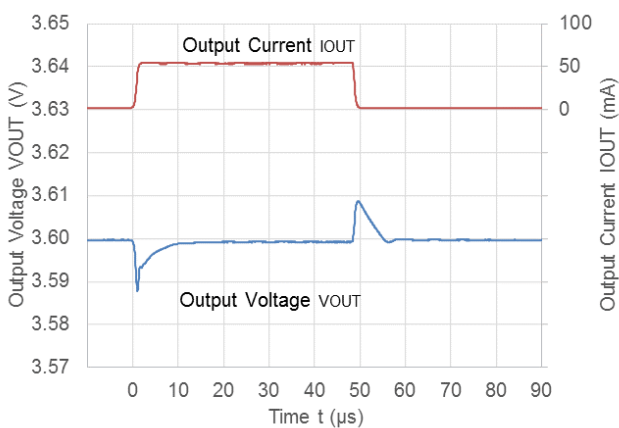

1 mA \leftrightarrow 200 mA

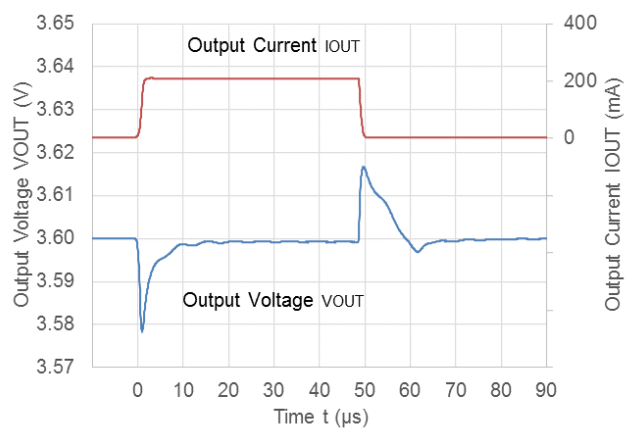

RP155Z

NO.EA-334-190610

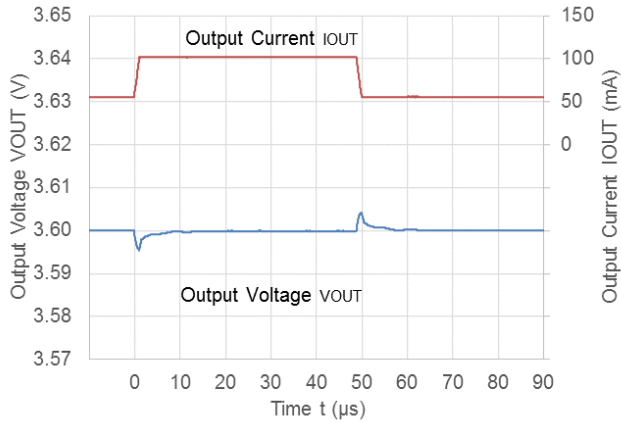
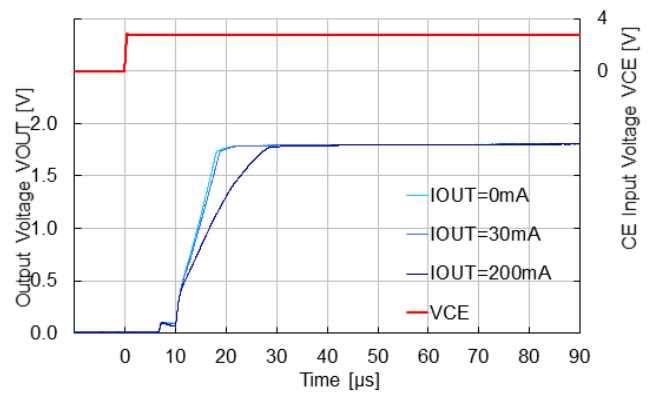
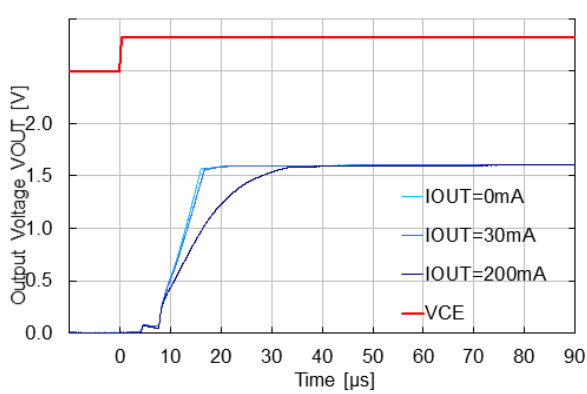
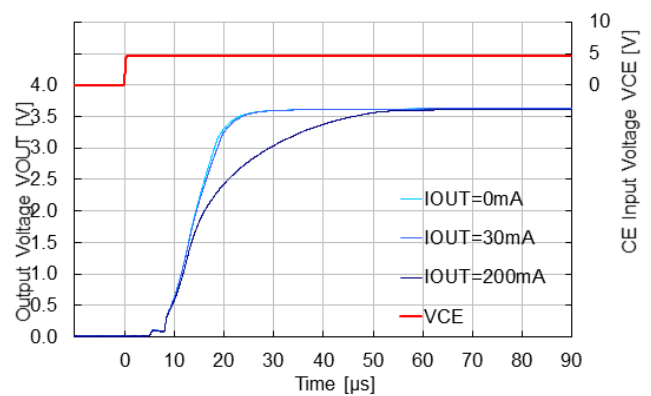
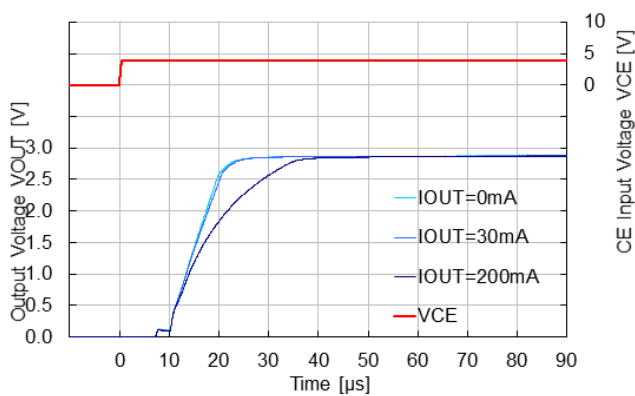
50 mA \leftrightarrow 200 mA**13) Turn On Speed with CE pin (C_{IN} = Ceramic 1.0 μ F, C_{OUT} = Ceramic 1.0 μ F, T_a = 25°C)****1.6 V (V_{SET1}/V_{SET2}), V_{IN} = 2.6 V****1.8 V (V_{SET1}/V_{SET2}), V_{IN} = 2.8 V****2.85 V (V_{SET1}/V_{SET2}), V_{IN} = 3.85 V****3.6 V (V_{SET1}/V_{SET2}), V_{IN} = 4.6 V**

14) Turn Off Speed with CE pin ($C_{IN} = \text{Ceramic } 1.0 \mu\text{F}$, $C_{OUT} = \text{Ceramic } 1.0 \mu\text{F}$, $T_a = 25^\circ\text{C}$)
RP155ZxxxB **RP155ZxxxB**
1.6 V (V_{SET1}/V_{SET2}), $V_{IN} = 2.6 \text{ V}$ **1.8 V (V_{SET1}/V_{SET2}), $V_{IN} = 2.8 \text{ V}$**

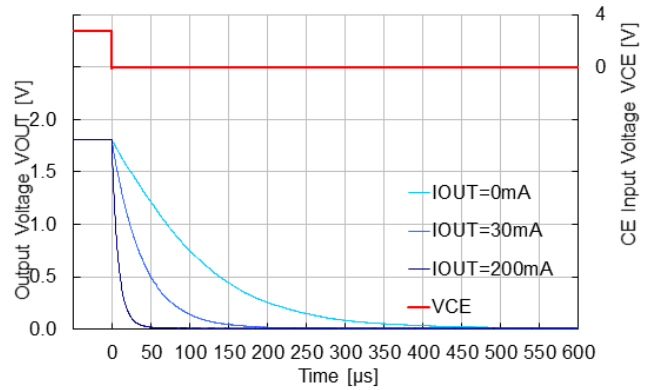
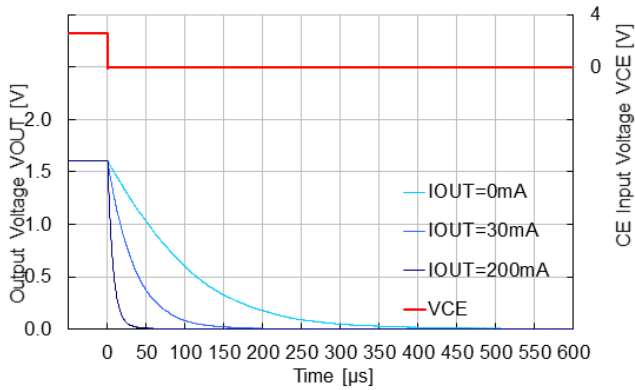

RP155ZxxxB
2.85 V (V_{SET1}/V_{SET2}), $V_{IN} = 3.85 \text{ V}$

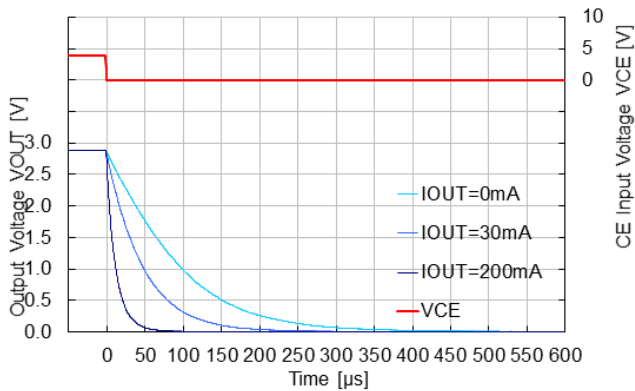

RP155ZxxxB
3.6 V (V_{SET1}/V_{SET2}), $V_{IN} = 4.6 \text{ V}$

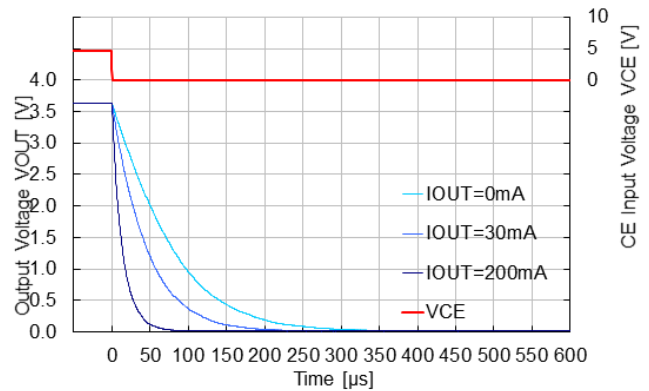

15) V_{OUT} Transient Response with VSEL Pin ($C_{IN} = \text{Ceramic } 1.0 \mu\text{F}$, $C_{OUT} = \text{Ceramic } 1.0 \mu\text{F}$, $t_r = t_f = 5 \mu\text{s}$, $T_a = 25^\circ\text{C}$)
RP155Z001B **RP155Z001B**
 $V_{SET1} (1.8 \text{ V}) \Rightarrow V_{SET2} (2.85 \text{ V})$ **$V_{SET2} (2.85 \text{ V}) \Rightarrow V_{SET1} (1.8 \text{ V})$**

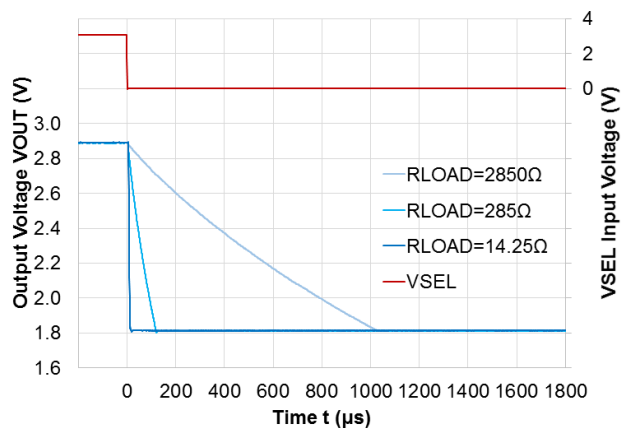
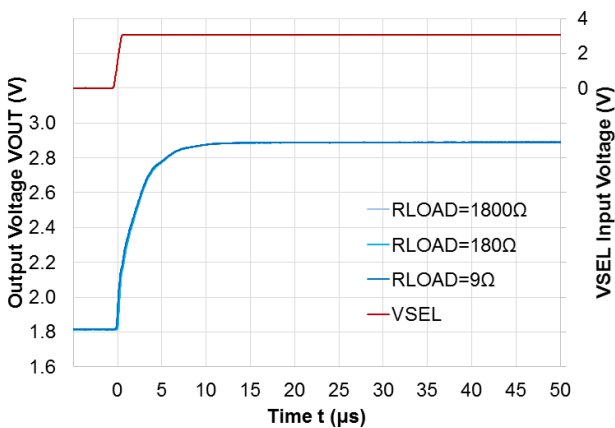

16) Inrush Current ($C_{IN} = \text{Ceramic } 1.0 \mu\text{F}$, $I_{OUT} = 0 \text{ mA}$, $T_a = 25^\circ\text{C}$)

1.6 V (V_{SET1}/V_{SET2}), $V_{IN} = 2.6 \text{ V}$

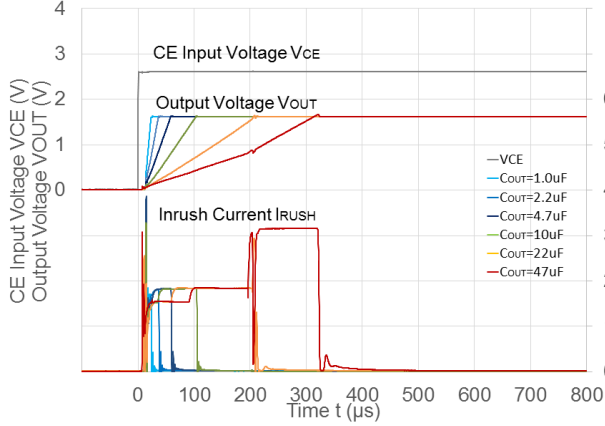

1.8 V (V_{SET1}/V_{SET2}), $V_{IN} = 2.8 \text{ V}$

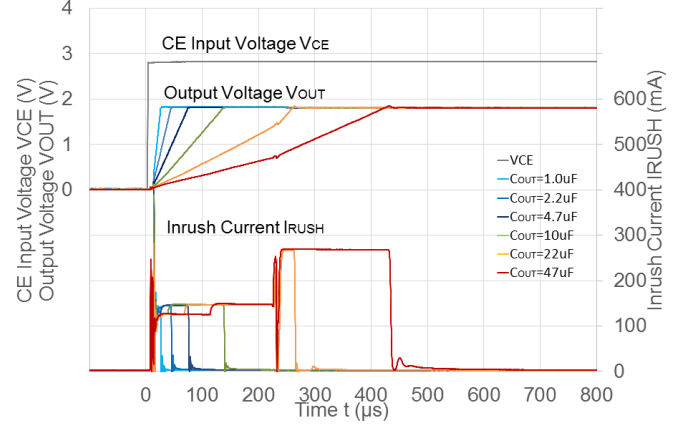

2.85 V (V_{SET1}/V_{SET2}), $V_{IN} = 3.85 \text{ V}$

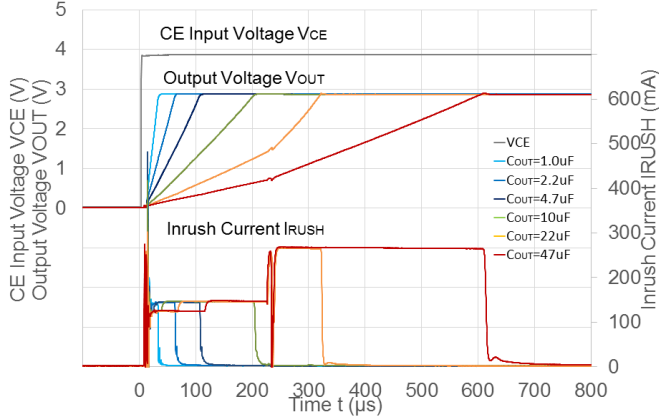

3.6 V (V_{SET1}/V_{SET2}), $V_{IN} = 4.6 \text{ V}$

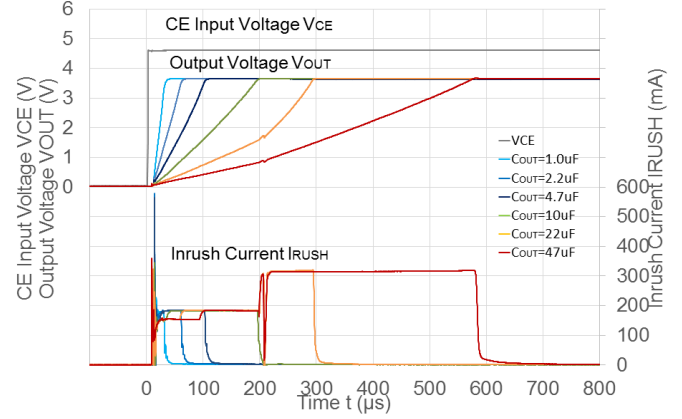

Test Circuit

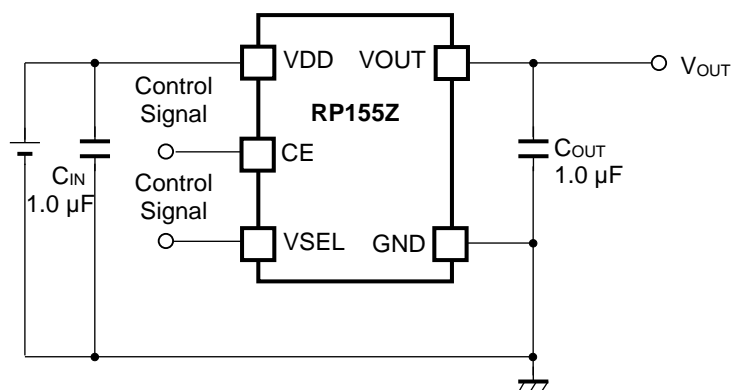

RP155Z circuit for measuring Typical Characteristics

Measurement Components of Typical Characteristics

Symbol	Description
C _{IN} , C _{OUT}	Ceramic Capacitor, 1.0 µF, GRM155B31A105KE15, MURATA

EQUIVALENT SERIES RESISTANCE VS. OUTPUT CURRENT

A ceramic output capacitor is recommended to be used but any output capacitor with low ESR could also be used. The graphs below show the relations between output current and ESR of an output capacitor when the average white noise level is 40 μV or less.

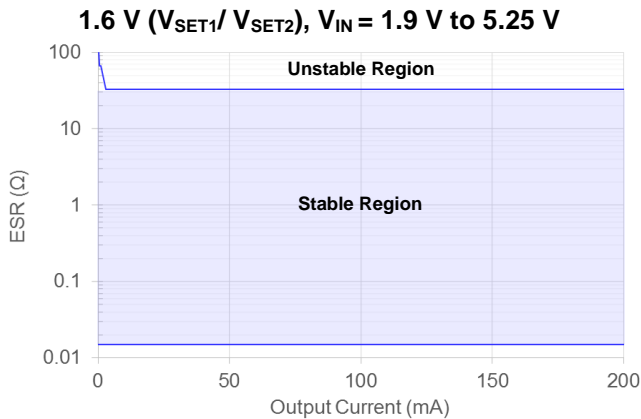
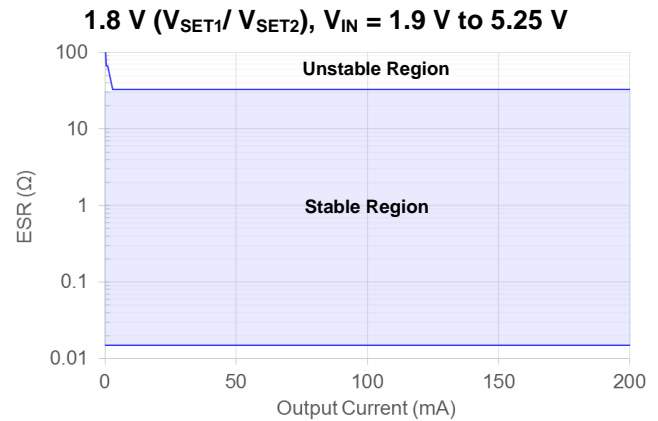
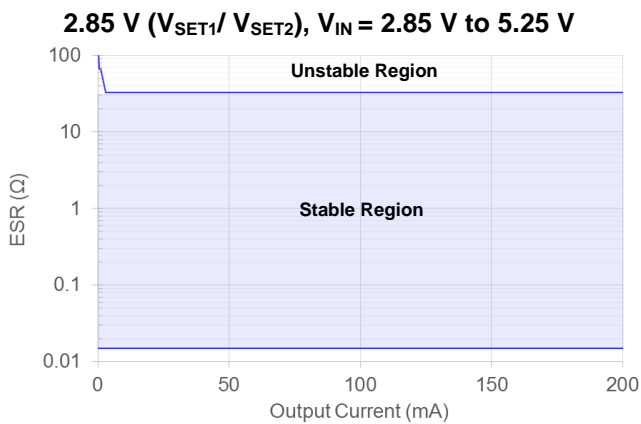
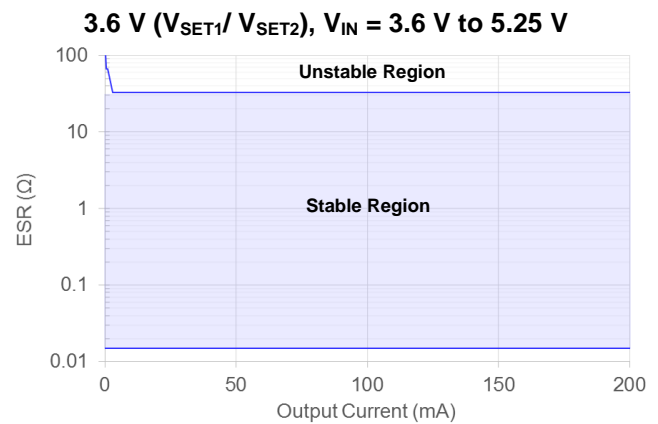
**Fig. 1 Range of Stable ESR Values****Fig. 2 Range of Stable ESR Values****Fig. 3 Range of Stable ESR Values****Fig. 4 Range of Stable ESR Values**

The power dissipation of the package is dependent on PCB material, layout, and environmental conditions. The following measurement conditions are based on JEDEC STD. 51.

Measurement Conditions

Item	Measurement Conditions
Environment	Mounting on Board (Wind Velocity = 0 m/s)
Board Material	Glass Cloth Epoxy Plastic (Four-Layer Board)
Board Dimensions	101.5 mm x 114.5 mm x 1.6 mm
Copper Ratio	Outer Layer (First Layer): 10% 50um Inner Layers (Second and Third Layers): 99.5 x 99.5mm 100% 70um Outer Layer (Fourth Layer): 10% 50um

Measurement Result

(Ta = 25°C, Tjmax = 125°C)

Item	Measurement Result
Power Dissipation	550 mW
Thermal Resistance (θ_{ja})	$\theta_{ja} = 180^{\circ}\text{C/W}$

θ_{ja} : Junction-to-Ambient Thermal Resistance

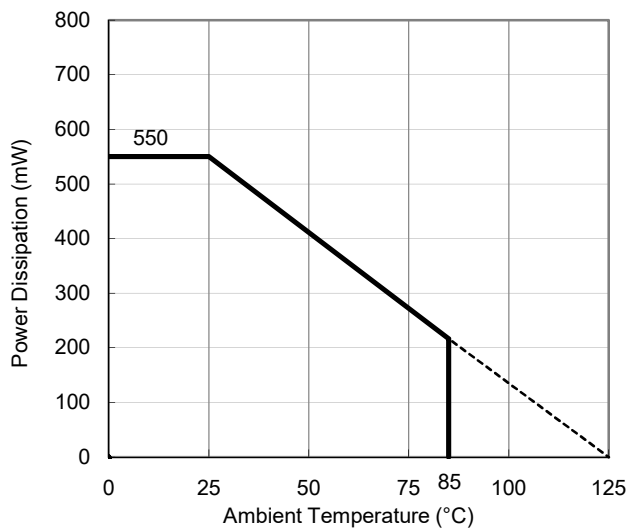

Power Dissipation vs. Ambient Temperature

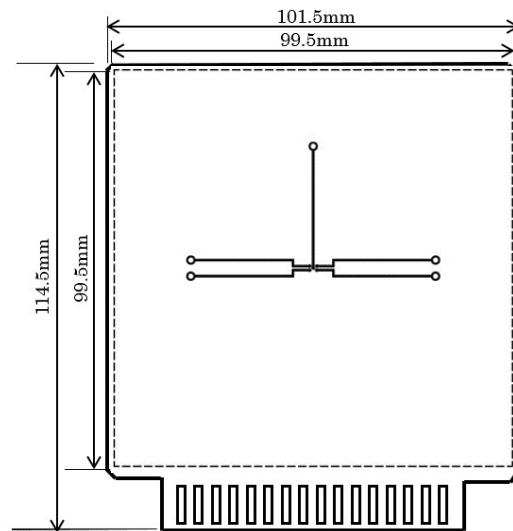

Measurement Board Pattern

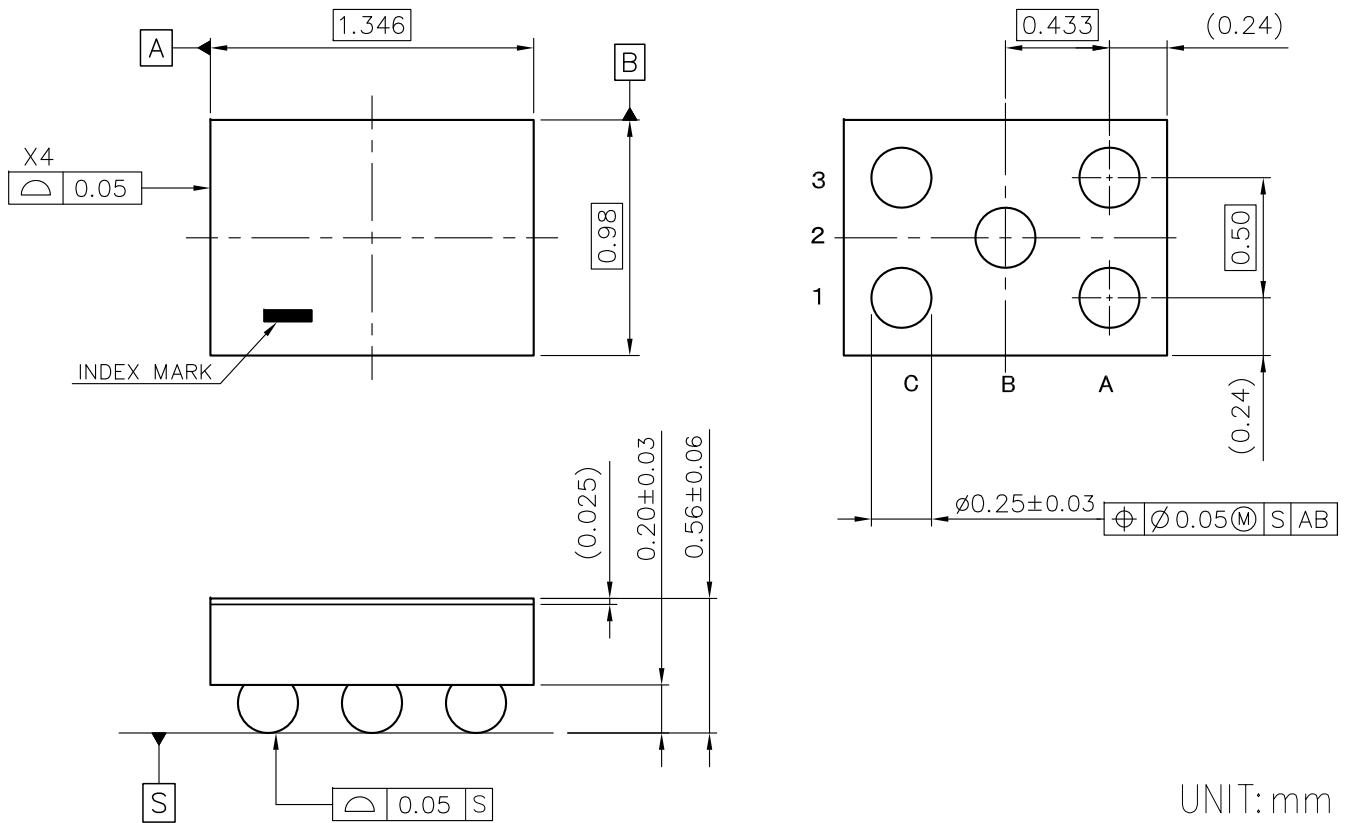

UNIT: mm

WLCSP-5-P1 Package Dimensions



1. The products and the product specifications described in this document are subject to change or discontinuation of production without notice for reasons such as improvement. Therefore, before deciding to use the products, please refer to Ricoh sales representatives for the latest information thereon.
2. The materials in this document may not be copied or otherwise reproduced in whole or in part without prior written consent of Ricoh.
3. Please be sure to take any necessary formalities under relevant laws or regulations before exporting or otherwise taking out of your country the products or the technical information described herein.
4. The technical information described in this document shows typical characteristics of and example application circuits for the products. The release of such information is not to be construed as a warranty of or a grant of license under Ricoh's or any third party's intellectual property rights or any other rights.
5. The products listed in this document are intended and designed for use as general electronic components in standard applications (office equipment, telecommunication equipment, measuring instruments, consumer electronic products, amusement equipment etc.). Those customers intending to use a product in an application requiring extreme quality and reliability, for example, in a highly specific application where the failure or misoperation of the product could result in human injury or death (aircraft, spacevehicle, nuclear reactor control system, traffic control system, automotive and transportation equipment, combustion equipment, safety devices, life support system etc.) should first contact us.
6. We are making our continuous effort to improve the quality and reliability of our products, but semiconductor products are likely to fail with certain probability. In order to prevent any injury to persons or damages to property resulting from such failure, customers should be careful enough to incorporate safety measures in their design, such as redundancy feature, fire containment feature and fail-safe feature. We do not assume any liability or responsibility for any loss or damage arising from misuse or inappropriate use of the products.
7. Anti-radiation design is not implemented in the products described in this document.
8. The X-ray exposure can influence functions and characteristics of the products. Confirm the product functions and characteristics in the evaluation stage.
9. WLCSP products should be used in light shielded environments. The light exposure can influence functions and characteristics of the products under operation or storage.
10. There can be variation in the marking when different AOI (Automated Optical Inspection) equipment is used. In the case of recognizing the marking characteristic with AOI, please contact Ricoh sales or our distributor before attempting to use AOI.
11. Please contact Ricoh sales representatives should you have any questions or comments concerning the products or the technical information.



Ricoh is committed to reducing the environmental loading materials in electrical devices with a view to contributing to the protection of human health and the environment.

Ricoh has been providing RoHS compliant products since April 1, 2006 and Halogen-free products since April 1, 2012.

RICOH RICOH ELECTRONIC DEVICES CO., LTD.

<https://www.e-devices.ricoh.co.jp/en/>

Sales & Support Offices

Ricoh Electronic Devices Co., Ltd.

Shin-Yokohama Office (International Sales)

2-3, Shin-Yokohama 3-chome, Kohoku-ku, Yokohama-shi, Kanagawa, 222-8530, Japan
Phone: +81-50-3814-7687 Fax: +81-45-474-0074

Ricoh Americas Holdings, Inc.

675 Campbell Technology Parkway, Suite 200 Campbell, CA 95008, U.S.A.
Phone: +1-408-610-3105

Ricoh Europe (Netherlands) B.V.

Semiconductor Support Centre

Prof. W.H. Keesomlaan 1, 1183 DJ Amstelveen, The Netherlands
Phone: +31-20-5474-309

Ricoh International B.V. - German Branch

Semiconductor Sales and Support Centre

Oberrather Strasse 6, 40472 Düsseldorf, Germany
Phone: +49-211-6546-0

Ricoh Electronic Devices Korea Co., Ltd.

3F, Haesung Bldg, 504, Teheran-ro, Gangnam-gu, Seoul, 135-725, Korea
Phone: +82-2-2135-5700 Fax: +82-2-2051-5713

Ricoh Electronic Devices Shanghai Co., Ltd.

Room 403, No.2 Building, No.690 Bibo Road, Pu Dong New District, Shanghai 201203,
People's Republic of China
Phone: +86-21-5027-3200 Fax: +86-21-5027-3299

Ricoh Electronic Devices Shanghai Co., Ltd.

Shenzhen Branch

1205, Block D (Jinlong Building), Kingkey 100, Hongbao Road, Luohu District,
Shenzhen, China
Phone: +86-755-8348-7600 Ext 225

Ricoh Electronic Devices Co., Ltd.

Taipei office

Room 109, 10F-1, No.51, Hengyang Rd., Taipei City, Taiwan
Phone: +886-2-2313-1621/1622 Fax: +886-2-2313-1623

X-ON Electronics

Largest Supplier of Electrical and Electronic Components

Click to view similar products for [LDO Voltage Regulators](#) category:

Click to view products by [Nisshinbo](#) manufacturer:

Other Similar products are found below :

[AP7363-SP-13](#) [L79M05TL-E](#) [TCR3DF185,LM\(CT](#) [TCR3DF24,LM\(CT](#) [TCR3DF285,LM\(CT](#) [TCR3DF31,LM\(CT](#) [TCR3DF45,LM\(CT](#)
[MP2013GQ-33-Z](#) [059985X](#) [NCP4687DH15T1G](#) [701326R](#) [TCR2EN28,LF\(S](#) [NCV8170AXV250T2G](#) [TCR3DF27,LM\(CT](#)
[TCR3DF19,LM\(CT](#) [TCR3DF125,LM\(CT](#) [TCR2EN18,LF\(S](#) [AP2112R5A-3.3TRG1](#) [AP7315-25W5-7](#) [IFX30081LDVGRNXUMA1](#)
[NCV47411PAAJR2G](#) [AP2113KTR-G1](#) [AP2111H-1.2TRG1](#) [ZLDO1117QK50TC](#) [AZ1117IH-1.8TRG1](#) [AZ1117ID-ADJTRG1](#)
[TCR3DG12,LF](#) [MIC5514-3.3YMT-T5](#) [MIC5512-1.2YMT-T5](#) [MIC5317-2.8YM5-T5](#) [SCD7912BTG](#) [NCP154MX180270TAG](#) [SCD33269T-](#)
[5.0G](#) [NCV8170BMX330TCG](#) [NCV8170AMX120TCG](#) [NCP706ABMX300TAG](#) [NCP153MX330180TCG](#) [NCP114BMX075TCG](#)
[MC33269T-3.5G](#) [CAT6243-ADJCMT5T](#) [TCR3DG33,LF](#) [AP2127N-1.0TRG1](#) [TCR4DG35,LF](#) [LT1117CST-3.3](#) [TAR5S15U\(TE85L,F\)](#)
[TAR5S18U\(TE85L,F\)](#) [TCR3UG19A,LF](#) [TCR4DG105,LF](#) [NCV8170AMX360TCG](#) [MIC94310-NYMT-T5](#)