300 mA 10 V Input LDO Regulator for Industrial Applications

NO. EA-341-160613

OUTLINE

The RP170x Series are LDO regulators featuring 300 mA output current that are developed with CMOS process technology. Because of the 10 V maximum input voltage, RP170x can be used in the industrial equipments such as FAs and smart meters. The supply current is Typ. 23 μ A though an excellent response characteristics. The output voltage range from 1.2 V is possible. The output voltage accuracy and temperature-drift coefficient of output voltage of the RP170x Series are excellent.

RP170x has a fold-back protection circuit and a thermal shutdown circuit. Moreover, a standby mode with ultra low supply current can be realized with the chip enable function.

SOT-23-5 and SOT-89-5 with high power dissipation packages are available.

This is a high-reliability semiconductor device for industrial applications (-Y) that has passed both the screening at high temperature and the reliability test with extended hours. This line of products operate in a wide temperature range from low temperature to high temperature to support harsh environment applications.

FEATURES

- Input Voltage Range (Maximum Rating)2.6 V to 10.0 V (12 V)
- Operating Temperature..... -50°C to 105°C
- Supply Current.....Typ. 23 μ A
- Standby ModeTyp. 0.1 μ A
- Dropout Voltage.....Typ. 0.20 V ($I_{OUT} = 100$ mA, $V_{OUT} = 3.0$ V)
.....Typ. 0.77 V ($I_{OUT} = 300$ mA, $V_{OUT} = 2.8$ V)
- Ripple RejectionTyp. 70 dB (f = 1 kHz)
- Temperature-Drift Coefficient of Output VoltageTyp. ± 80 ppm/°C
- Line Regulation.....Typ. 0.02%/V
- Output Voltage Accuracy $\pm 1.0\%$
- Packages.....SOT-23-5, SOT-89-5
- Output Voltage Range1.2 V/ 1.5 V/ 1.8 V/ 2.5 V/ 2.8 V/3.0 V/ 3.3 V/ 3.4 V/ 5.0 V/ 6.0 V
Contact Ricoh sales representatives for other voltages.
- Built-in Fold Back Protection Circuit..... Typ. 40mA (Current at short mode)
- Built-in Thermal Shutdown Circuit..... Shutdown Temperature at 165°C
- Built-in Constant Slope Circuit (Soft-start Function)
- Ceramic capacitors are recommended to be used with this IC.....1.0 μ F or more

APPLICATIONS

- Industrial equipments such as FAs and smart meters
- Equipments used under high-temperature conditions such as surveillance camera and vending machine
- Equipments accompanied by self-heating such as motor and lighting

BLOCK DIAGRAMS

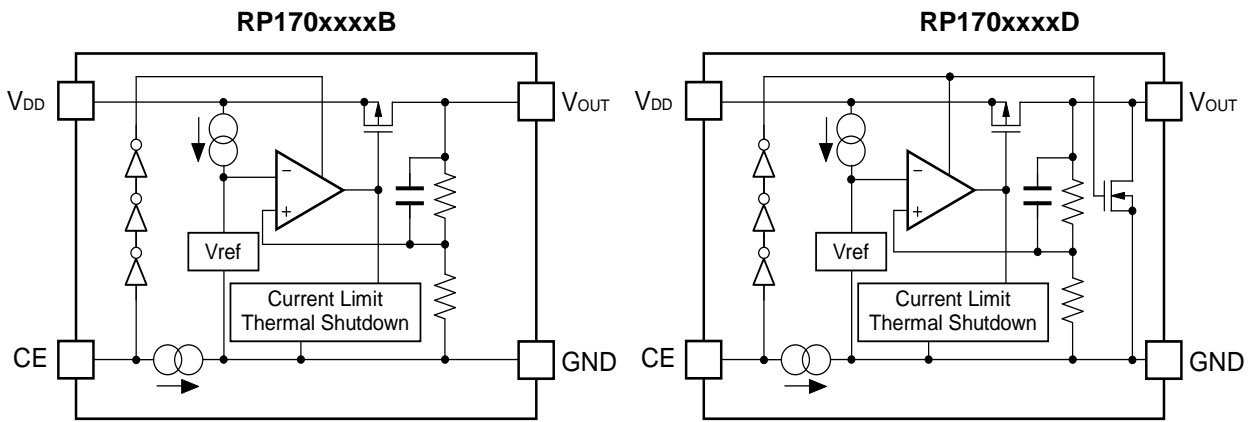

SELECTION GUIDE

The output voltage, auto discharge function, and package for the ICs can be selected at the user's request.

Product Name	Package	Quantity per Reel	Pb Free	Halogen Free
RP170Nxx1*-TR-YE	SOT-23-5	3,000 pcs	Yes	Yes
RP170Hxx1*-T1-YE	SOT-89-5	1,000 pcs	Yes	Yes

xx: Specify the set output voltage (V_{SET})
 1.2 V (12) / 1.5 V (15) / 1.8 V (18) / 2.5 V (25) / 2.8 V (28) / 3.0 V (30) / 3.3 V (33) /
 3.4 V (34) / 5.0 V (50) / 6.0 V (60)
 Contact Ricoh sales representatives for other voltages.

* : The auto discharge functions at off state are as follows.
 (B) without auto discharge function at off state
 (D) with auto discharge function at off state

Auto-discharge function quickly lowers the output voltage to 0 V by releasing the electrical charge accumulated in the external capacitor when the chip enable signal is switched from the active mode to the standby mode.

PIN DESCRIPTIONS

• SOT-23-5

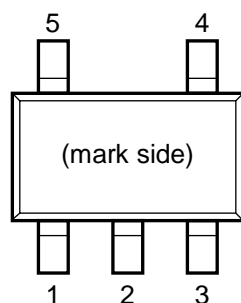

• SOT-89-5

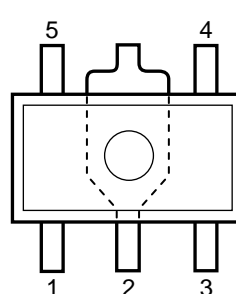

• SOT-23-5

Pin No	Symbol	Pin Description
1	V_{DD}	Input Pin
2	GND	Ground Pin
3	CE	Chip Enable Pin ("H" Active)
4	NC	No Connection
5	V_{OUT}	Output Pin

• SOT-89-5

Pin No	Symbol	Pin Description
1	V_{OUT}	Output Pin
2	GND	Ground Pin
3	CE	Chip Enable Pin ("H" Active)
4	NC	No Connection
5	V_{DD}	Input Pin

ABSOLUTE MAXIMUM RATINGS

Symbol	Item		Rating	Unit
V_{IN}	Input Voltage		12	V
V_{CE}	Input Voltage (CE Pin)		12	V
V_{OUT}	Output Voltage		-0.3 to $V_{IN} + 0.3$	V
I_{OUT}	Output Current		330	mA
P_D	Power Dissipation (SOT-23-5)*	Standard Land Pattern	525	mW
	Power Dissipation (SOT-89-5)*	High Wattage Land Pattern	1620	
		Standard Land Pattern	1120	
T_j	Junction Temperature		-50 to 150	°C
T_{stg}	Storage Temperature Range		-55 to 150	°C

* Please refer to *PACKAGE INFORMATION* for detailed information.

ABSOLUTE MAXIMUM RATINGS

Electronic and mechanical stress momentarily exceeded absolute maximum ratings may cause the permanent damages and may degrade the life time and safety for both device and system using the device in the field. The functional operation at or over these absolute maximum ratings is not assured.

RECOMMENDED OPERATING CONDITIONS

Symbol	Item	Rating	Unit
V_{IN}	Input Voltage	2.6 to 10	V
T_a	Operating Temperature Range	-50 to 105	°C

RECOMMENDED OPERATING CONDITIONS

All of electronic equipment should be designed that the mounted semiconductor devices operate within the recommended operating conditions. The semiconductor devices cannot operate normally over the recommended operating conditions, even if when they are used over such conditions by momentary electronic noise or surge. And the semiconductor devices may receive serious damage when they continue to operate over the recommended operating conditions.

ELECTRICAL CHARACTERISTICS

$V_{IN} = V_{SET} + 1\text{ V}$, $I_{OUT} = 1\text{ mA}$, unless otherwise noted.

The specifications surrounded by are guaranteed by design engineering at $-50^{\circ}\text{C} \leq T_a \leq 105^{\circ}\text{C}$.

RP170xxxxB/D

($T_a = 25^{\circ}\text{C}$)

Symbol	Item	Conditions	Min.	Typ.	Max.	Unit	
V_{OUT}	Output Voltage	$1.5\text{ V} < V_{SET}$	$T_a = 25^{\circ}\text{C}$	$V_{SET} \times 0.99$		$V_{SET} \times 1.01$	V
			$-50^{\circ}\text{C} \leq T_a \leq 105^{\circ}\text{C}$	$V_{SET} \times 0.965$		$V_{SET} \times 1.03$	
		$V_{SET} \leq 1.5\text{ V}$	$T_a = 25^{\circ}\text{C}$	-15		15	mV
			$-50^{\circ}\text{C} \leq T_a \leq 105^{\circ}\text{C}$	-53		45	
I_{OUT}	Output Current		300			mA	
$\frac{\Delta V_{OUT}}{\Delta I_{OUT}}$	Load Regulation	$0.1\text{ mA} \leq I_{OUT} \leq 300\text{ mA}$		10	80	mV	
V_{DIF}	Dropout Voltage	$I_{OUT} = 300\text{ mA}$	Refer to the <i>Product-specific Electrical Characteristics</i>				
I_{SS}	Supply Current	$I_{OUT} = 0\text{ mA}$		23	45	μA	
Istandby	Supply Current (Standby Mode)	$V_{IN} = 10.0\text{ V}$ $V_{CE} = \text{GND}$		0.1	1.2	μA	
$\frac{\Delta V_{OUT}}{\Delta V_{IN}}$	Line Regulation	$V_{SET} + 0.5\text{ V} \leq V_{IN} \leq 10.0\text{ V}$ (When $V_{SET} \leq 2.1\text{ V}$, $2.6\text{ V} \leq V_{IN} \leq 10.0\text{ V}$)		± 0.02	± 0.25	%/V	
I_{SC}	Short Current Limit	$V_{OUT} = 0\text{ V}$		40		mA	
I_{PD}	CE Pull-down Current			0.30		μA	
V_{CEH}	CE Input Voltage "H"		1.7			V	
V_{CEL}	CE Input Voltage "L"				0.8	V	
T_{TSD}	Thermal Shutdown Temperature	Junction Temperature		165		$^{\circ}\text{C}$	
T_{TSR}	Thermal Shutdown Released Temperature	Junction Temperature		110		$^{\circ}\text{C}$	
R_{LOW}	Nch On Resistance for Auto Discharge (D Version Only)	$V_{CE} = 0\text{ V}$ $V_{IN} = 7.0\text{ V}$		250		Ω	

All test items listed under Electrical Characteristics are done under the pulse load condition ($T_j \approx T_a = 25^{\circ}\text{C}$).

RP170x-Y

NO. EA-341-160613

 $V_{IN} = V_{SET} + 1\text{ V}$, $I_{OUT} = 1\text{ mA}$, unless otherwise noted.The specifications surrounded by are guaranteed by design engineering at $-50^{\circ}\text{C} \leq T_a \leq 105^{\circ}\text{C}$.**Product-specific Electrical Characteristics**

(Ta = 25°C)

Product Name	V _{OUT} [V] (Ta = 25°C)			V _{OUT} [V] (Ta = -50 to 105°C)			V _{DIF} [V]	
	MIN.	TYP.	MAX.	MIN.	TYP.	MAX.	TYP.	MAX.
RP170x121x	1.185	1.200	1.215	1.147	1.200	1.245	1.400	1.925
RP170x151x	1.485	1.500	1.515	1.447	1.500	1.545	1.200	1.655
RP170x181x	1.782	1.800	1.818	1.737	1.800	1.854	0.980	1.305
RP170x251x	2.475	2.500	2.525	2.413	2.500	2.575	0.770	1.185
RP170x281x	2.772	2.800	2.828	2.702	2.800	2.884		
RP170x301x	2.970	3.000	3.030	2.895	3.000	3.090	0.600	0.995
RP170x331x	3.267	3.300	3.333	3.185	3.300	3.399		
RP170x341x	3.366	3.400	3.434	3.281	3.400	3.502		
RP170x501x	4.950	5.000	5.050	4.825	5.000	5.150	0.500	0.875
RP170x601x	5.940	6.000	6.060	5.790	6.000	6.180		

TYPICAL APPLICATION

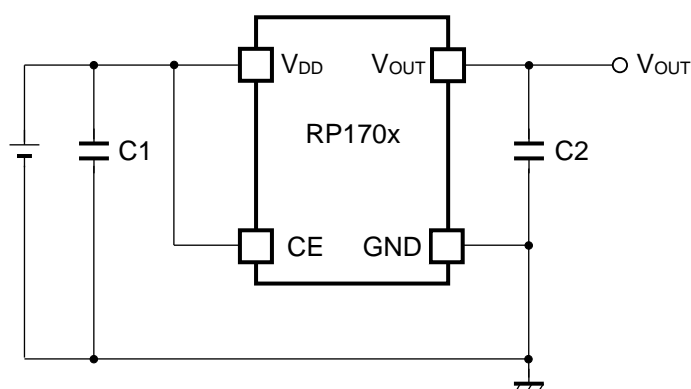

External Components:

Symbol	Description
C2	Ceramic 1.0 μ F (MURATA GRM155B31A105KE15)

TECHNICAL NOTES

When using these ICs, consider the following points:

Phase Compensation

In these ICs, phase compensation is made for securing stable operation even if the load current is varied. For this purpose, use a capacitor C2 with 1.0 μ F or more and good ESR (Equivalent Series Resistance).

(Note: If additional ceramic capacitors are connected with parallel to the output pin with an output capacitor for phase compensation, the operation might be unstable. Because of this, test these ICs with as same external components as ones to be used on the PCB.)

PCB Layout

Make V_{DD} and GND lines sufficient. If their impedance is high, noise pickup or unstable operation may result. Connect a capacitor C1 with a capacitance value as much as 1.0 μ F or more between V_{DD} and GND, and as close as possible to the pins.

Set external components, especially the output capacitor C2, as close as possible to the ICs, and make wiring as short as possible.

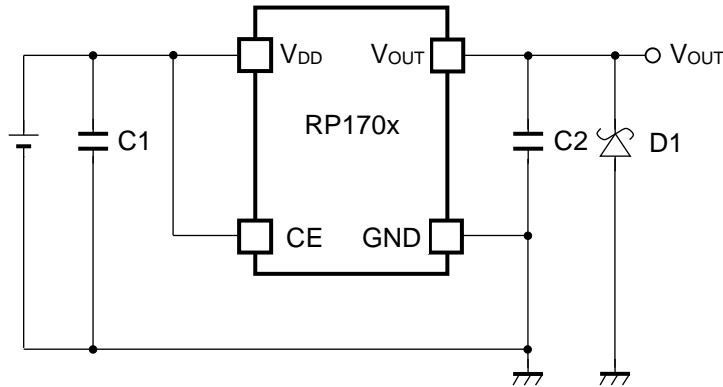
TYPICAL APPLICATION FOR IC CHIP BREAKDOWN PREVENTION**External Components:**

Symbol	Description
C2	1.0 μ F (Ceramic), MURATA, GRM155B31A105KE15

When a sudden surge of electrical current travels along the V_{OUT} pin and GND due to a short-circuit, electrical resonance of a circuit involving an output capacitor (C2) and a short circuit inductor generates a negative voltage and may damage the device or the load devices. Connecting a schottky diode (D1) between the V_{OUT} pin and GND has the effect of preventing damage to them.

PACKAGE INFORMATION

POWER DISSIPATION (SOT-23-5)

The power dissipation of the package is dependent on PCB material, layout, and environmental conditions. The following conditions are used in this measurement.

Measurement Conditions

	Standard Test Land Pattern
Environment	Mounting on Board (Wind Velocity = 0 m/s)
Board Material	Glass Cloth Epoxy Plastic (Double-Sided Board)
Board Dimensions	40 mm × 40 mm × 1.6 mm
Copper Ratio	Top Side: Approx. 50% Bottom Side: Approx. 50%
Through-holes	φ 0.5 mm × 44 pcs

Measurement Result

(Ta = 25°C, Tjmax = 150°C)

	Standard Test Land Pattern	Free Air
Power Dissipation	525 mW	310 mW
Thermal Resistance	$\theta_{ja} = (150 - 25^\circ\text{C}) / 0.525 \text{ W} = 238^\circ\text{C/W}$	400°C/W

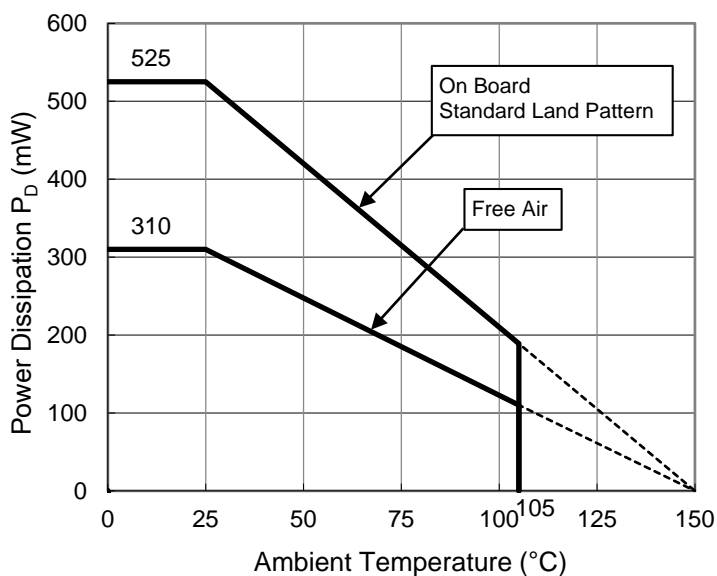

Power Dissipation vs. Ambient Temperature

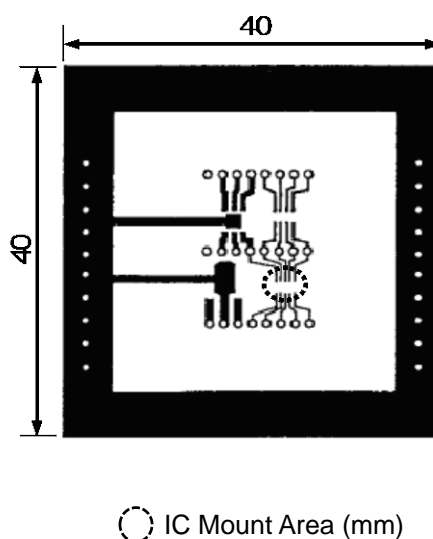

Measurement Board Pattern

RP170x-Y

NO. EA-341-160613

PACKAGE DIMENSIONS (SOT-23-5)

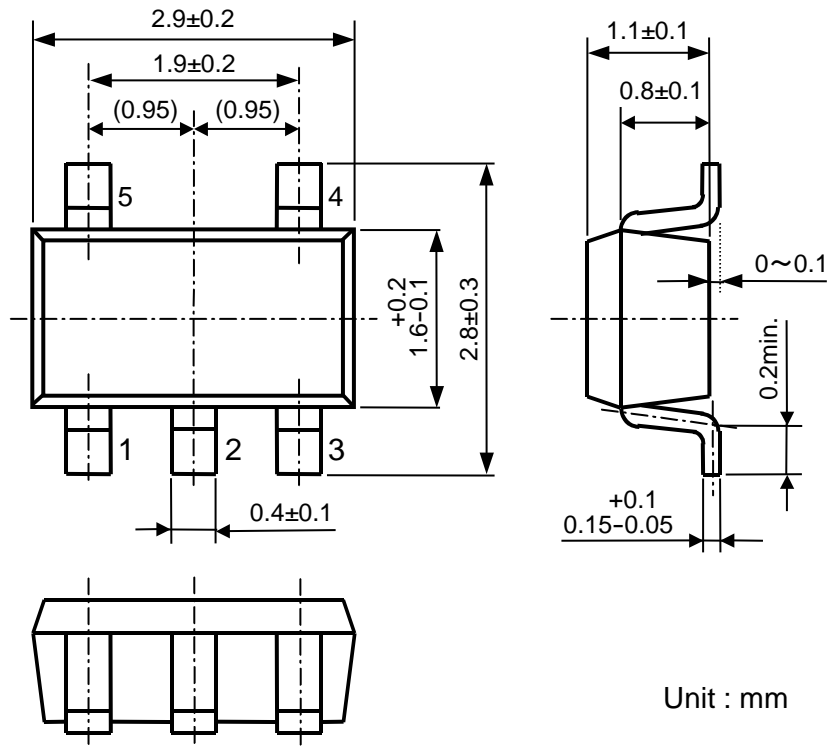

SOT-23-5 Package Dimensions

MARK SPECIFICATION (SOT-23-5)

①②③: Product Code ... Refer to MARK SPECIFICATION TABLE (SOT-23-5).

④⑤: Lot Number ... Alphanumeric Serial Number

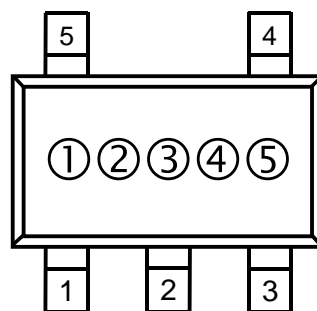

SOT-23-5 Mark Specification

MARK SPECIFICATION TABLE (SOT-23-5)
RP170Nxx1B

Product Name	①	②	③	V _{SET}
RP170N121B	F	A	A	1.2 V
RP170N151B	F	A	E	1.5 V
RP170N181B	F	A	H	1.8 V
RP170N251B	F	A	R	2.5 V
RP170N281B	F	A	U	2.8 V
RP170N301B	F	A	X	3.0 V
RP170N331B	G	A	A	3.3 V
RP170N341B	G	A	B	3.4 V
RP170N501B	G	A	T	5.0 V
RP170N601B	H	A	D	6.0 V

RP170Nxx1D

Product Name	①	②	③	V _{SET}
RP170N121D	F	B	A	1.2 V
RP170N151D	F	B	E	1.5 V
RP170N181D	F	B	H	1.8 V
RP170N251D	F	B	R	2.5 V
RP170N281D	F	B	U	2.8 V
RP170N301D	F	B	X	3.0 V
RP170N331D	G	B	A	3.3 V
RP170N341D	G	B	B	3.4 V
RP170N501D	G	B	T	5.0 V
RP170N601D	H	B	D	6.0 V

RP170x-Y

NO. EA-341-160613

POWER DISSIPATION (SOT-89-5)

The power dissipation of the package is dependent on PCB material, layout, and environmental conditions. The following conditions are used in this measurement.

Measurement Conditions

	High Wattage Test Land Pattern	Standard Test Land Pattern
Environment	Mounting on Board (Wind Velocity = 0 m/s)	Mounting on Board (Wind Velocity = 0 m/s)
Board Material	Glass Cloth Epoxy Plastic (Double-sided Board)	Glass Cloth Epoxy Plastic (Double-sided Board)
Board Dimensions	30 mm x 30 mm x 1.6 mm	50 mm x 50 mm x 1.6 mm
Copper Ratio	Top Side: Approx. 20% Bottom Side: Approx. 100%	Top Side: Approx. 10% Bottom Side: Approx. 100%
Through-holes	φ 0.85 mm x 10 pcs	-

Measurement Result

(Ta = 25°C, Tjmax = 150°C)

	High Wattage Test Land Pattern	Standard	Free Air
Power Dissipation	1620 mW	1120 mW	620 mW
Thermal Resistance	77°C/W	111°C/W	200°C/W

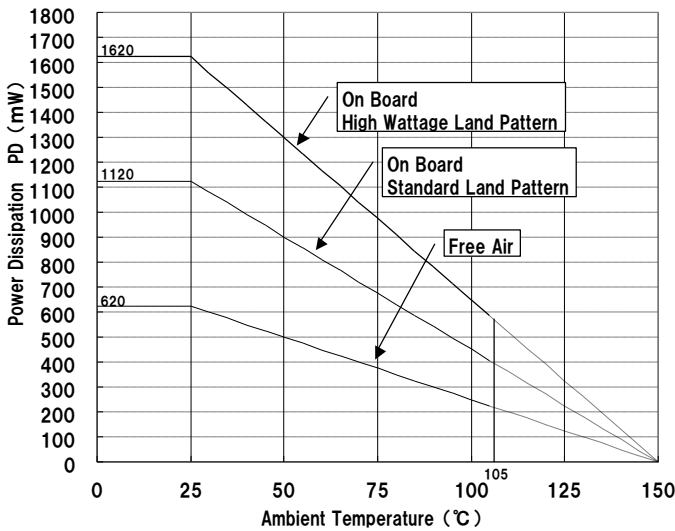

Power Dissipation vs. Ambient Temperature

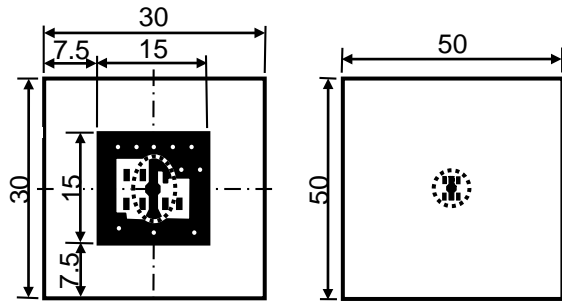

High Wattage

Standard

○ IC Mount Area (mm)

Measurement Board Pattern

PACKAGE DIMENSIONS (SOT-89-5)

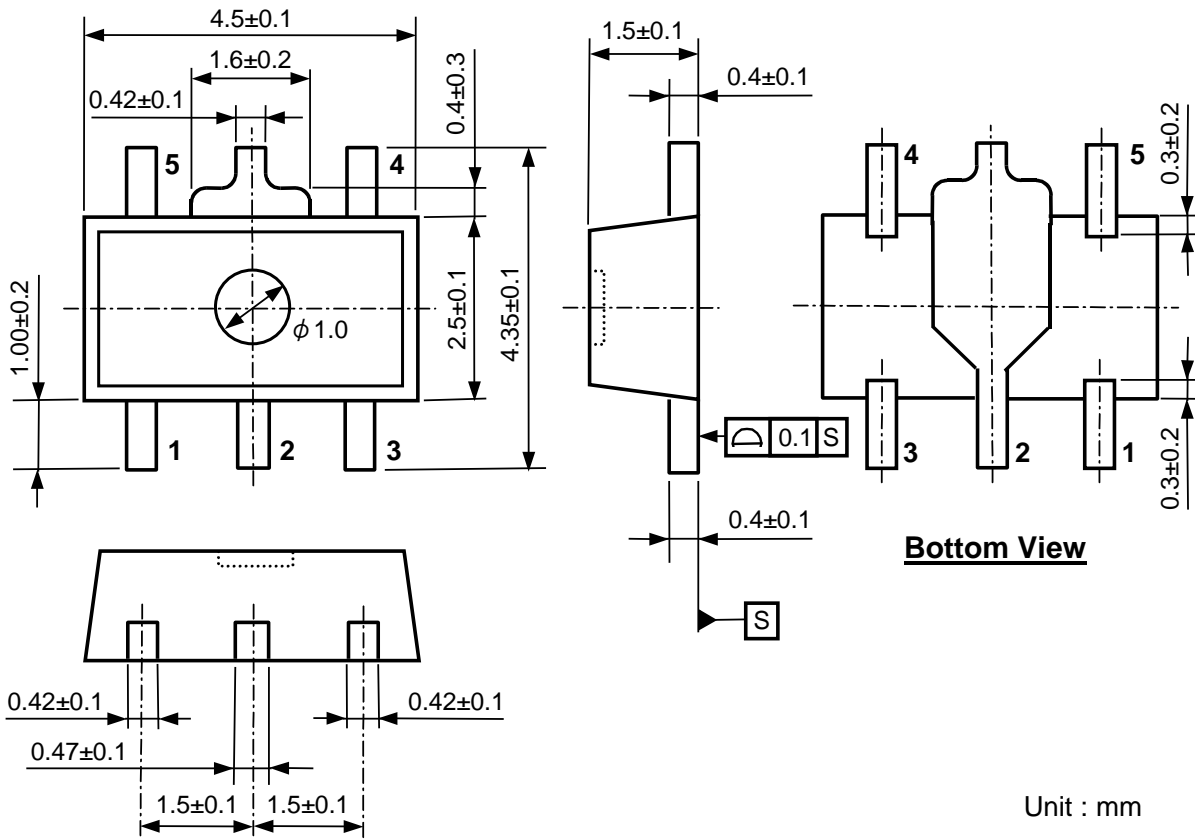

MARK SPECIFICATION (SOT-89-5)

①②③④: Product Code ... Refer to MARK SPECIFICATION TABLE (SOT-89-5)

⑤⑥: Lot Number ... Alphanumeric Serial Number

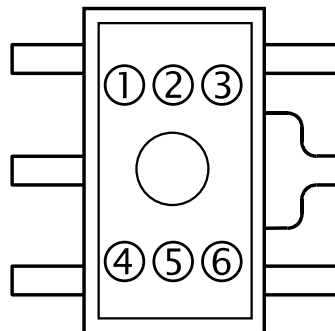

RP170x-Y

NO. EA-341-160613

MARK SPECIFICATION TABLE (SOT-89-5)**RP170Hxx1B**

Product Name	①	②	③	④	V _{SET}
RP170H121B	Y	1	2	B	1.2 V
RP170H151B	Y	1	5	B	1.5 V
RP170H181B	Y	1	8	B	1.8 V
RP170H251B	Y	2	5	B	2.5 V
RP170H281B	Y	2	8	B	2.8 V
RP170H301B	Y	3	0	B	3.0 V
RP170H331B	Y	3	3	B	3.3 V
RP170H341B	Y	3	4	B	3.4 V
RP170H501B	Y	5	0	B	5.0 V
RP170H601B	Y	6	0	B	6.0 V

RP170Hxx1D

Product Name	①	②	③	④	V _{SET}
RP170H121D	Y	1	2	D	1.2 V
RP170H151D	Y	1	5	D	1.5 V
RP170H181D	Y	1	8	D	1.8 V
RP170H251D	Y	2	5	D	2.5 V
RP170H281D	Y	2	8	D	2.8 V
RP170H301D	Y	3	0	D	3.0 V
RP170H331D	Y	3	3	D	3.3 V
RP170H341D	Y	3	4	D	3.4 V
RP170H501D	Y	5	0	D	5.0 V
RP170H601D	Y	6	0	D	6.0 V

TEST CIRCUITS

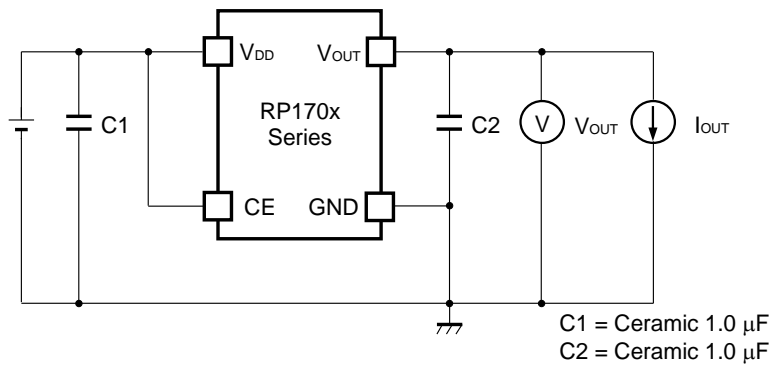

Basic Test Circuit

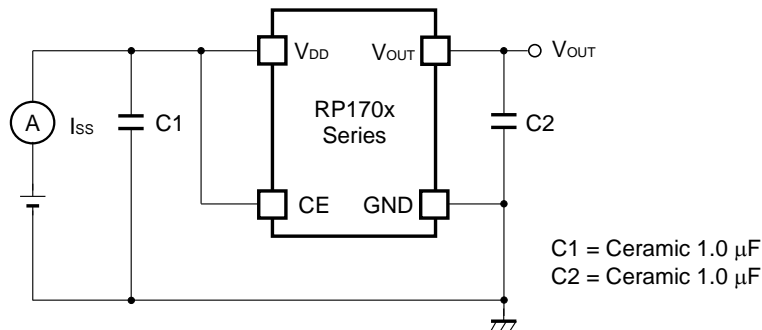

Test Circuit for Supply Current

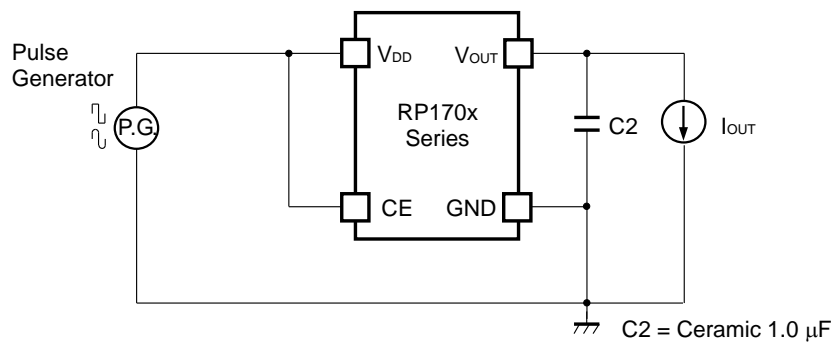

Test Circuit for Ripple Rejection

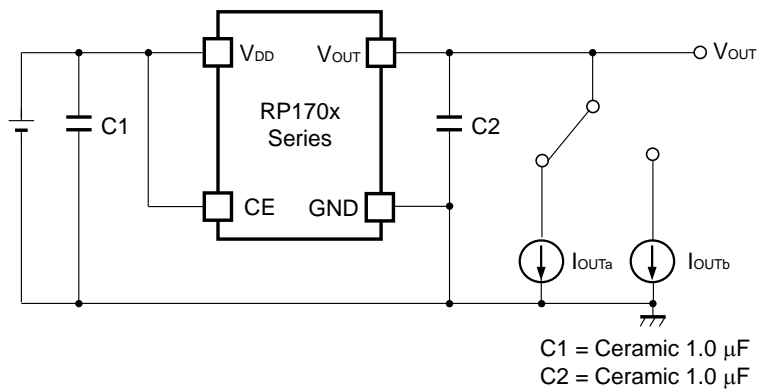

Test Circuit for Load Transient Response

TYPICAL CHARACTERISTICS

Note: Typical Characteristics are intended to be used as reference data; they are not guaranteed.

1) Output Voltage vs. Output Current (Ta = 25°C)

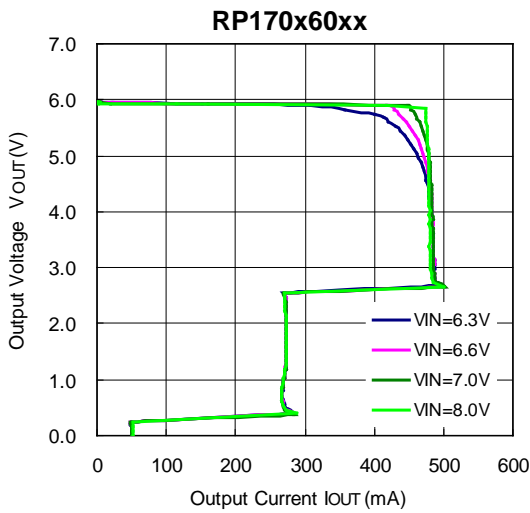
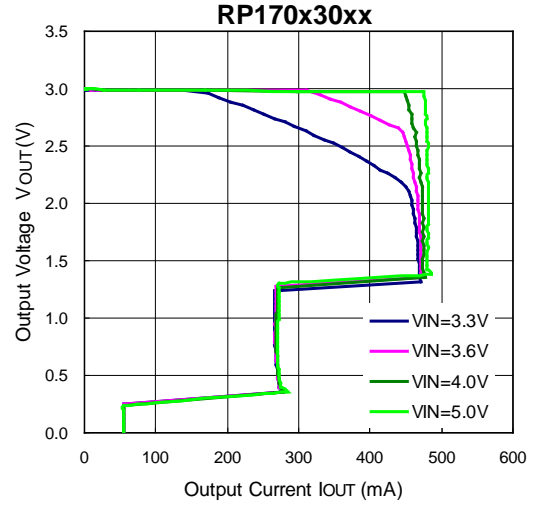
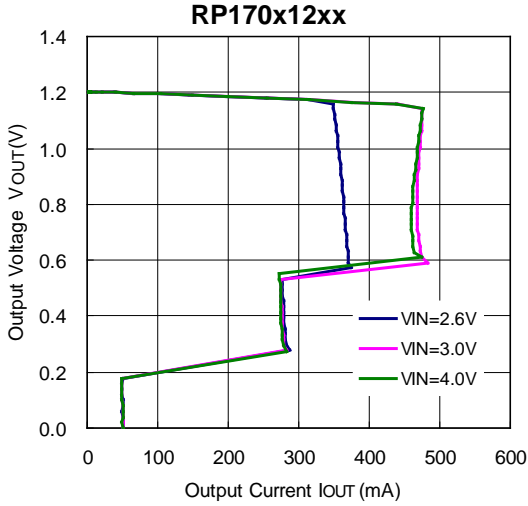

2) Output Voltage vs. Input Voltage (Ta = 25°C)

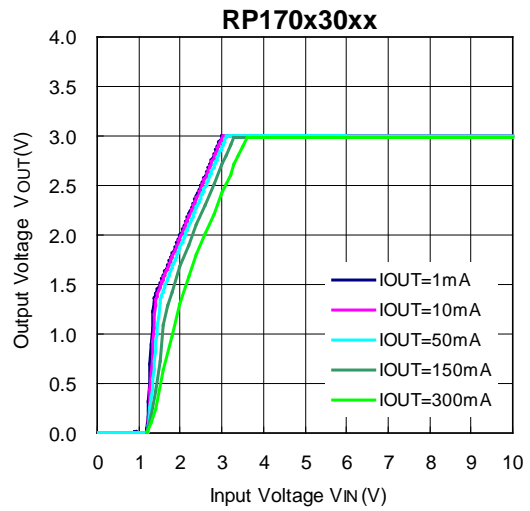
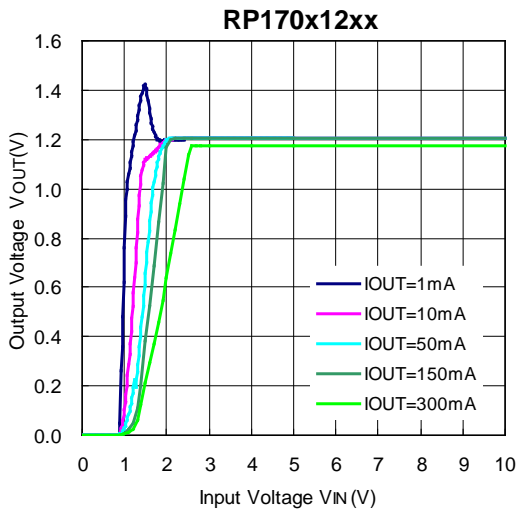

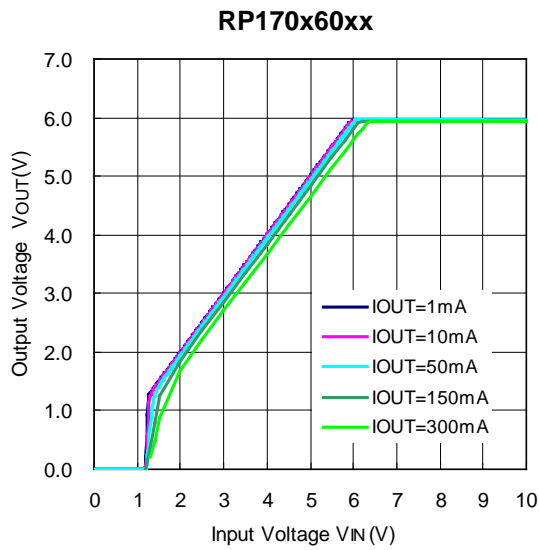

3) Supply Current vs. Input Voltage ($T_a = 25^\circ\text{C}$)

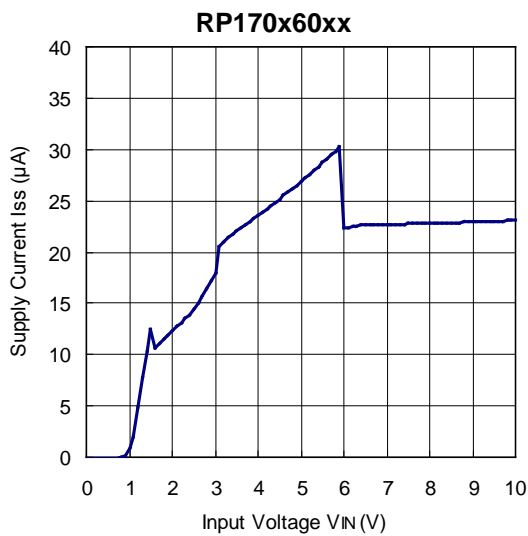
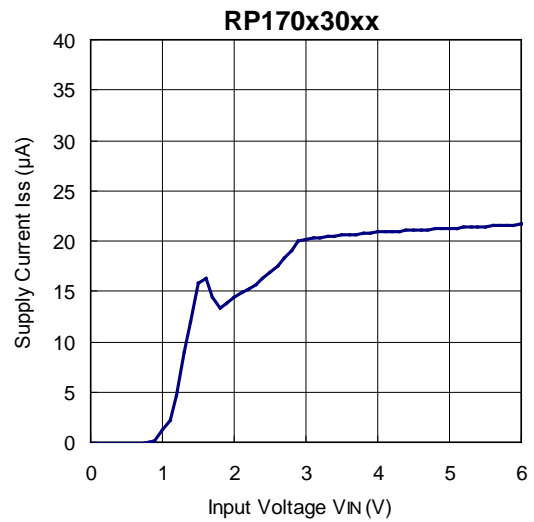
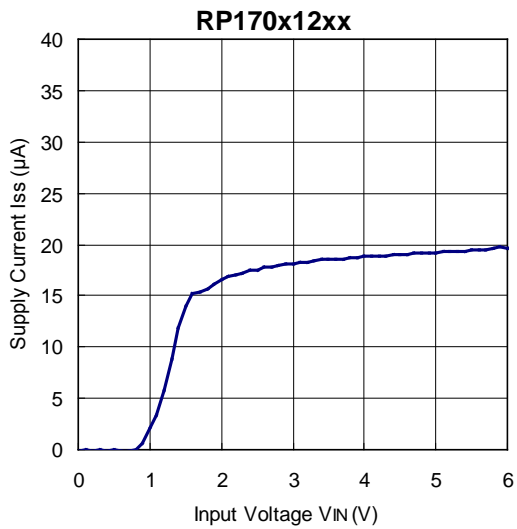

4) Supply Current vs. Output Current (Ta = 25°C)

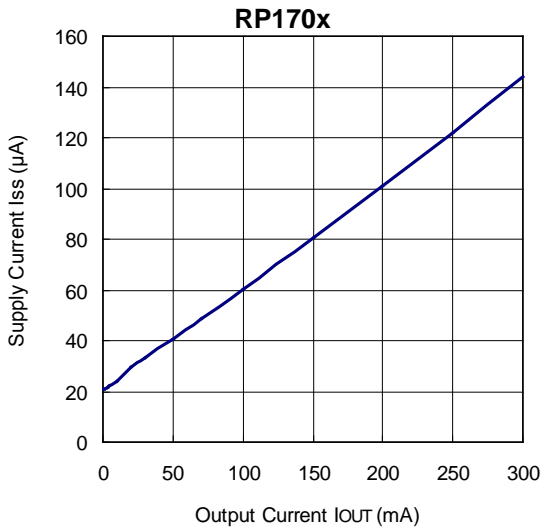

5) Output Voltage vs. Temperature

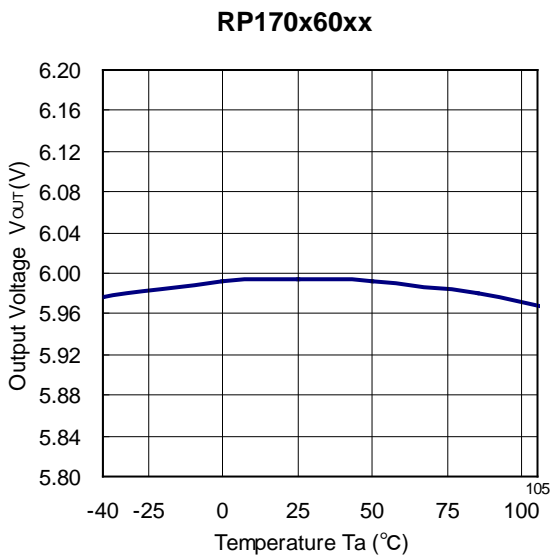
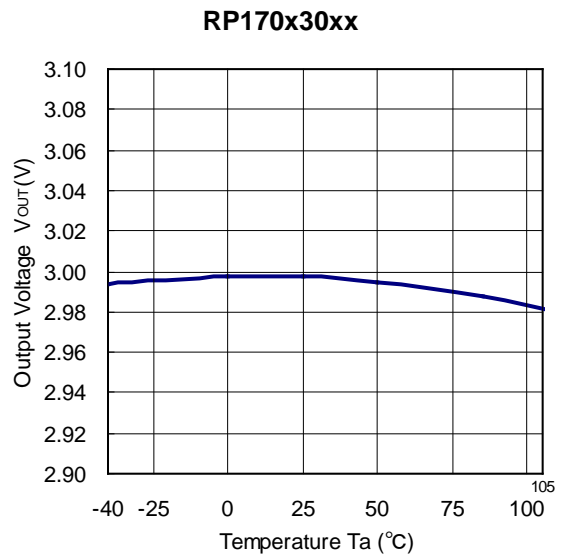
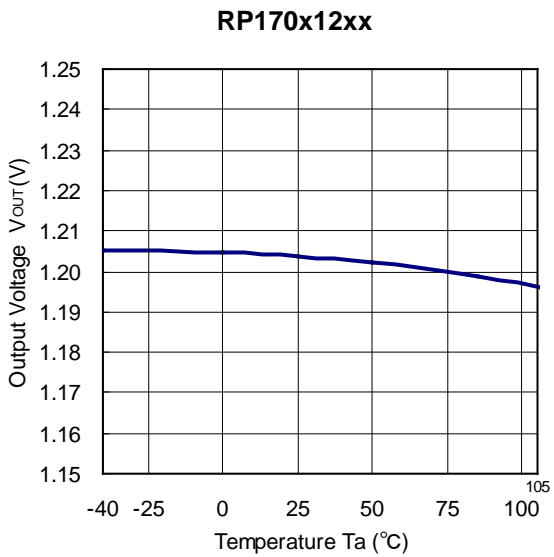

6) Supply Current vs. Temperature

RP170x12xx

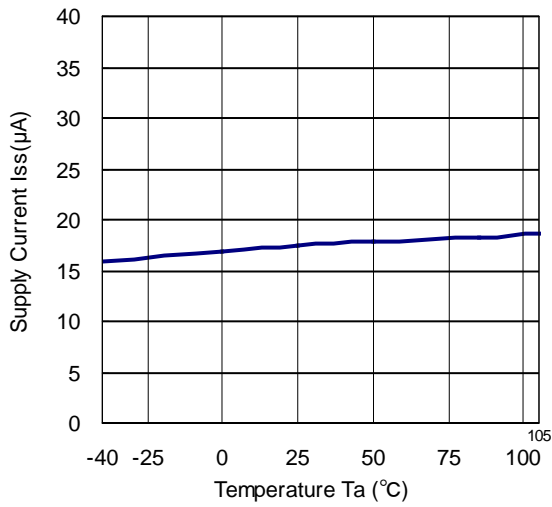

RP170x30xx

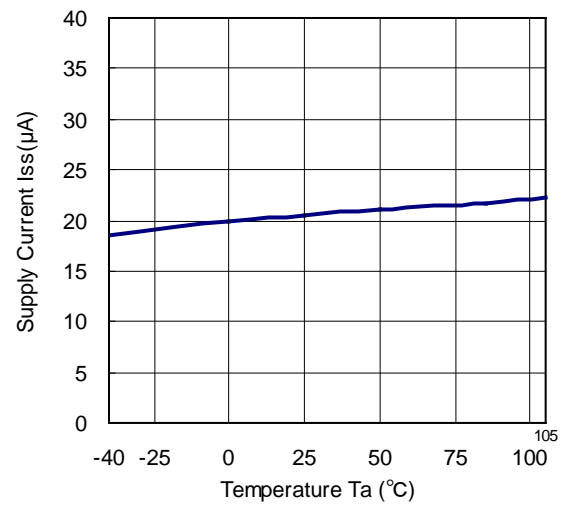

RP170x60xx

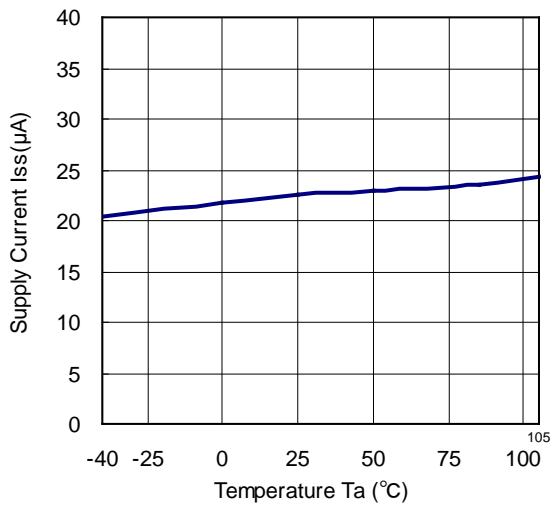

7) Dropout Voltage vs. Output Current

RP170x12xx

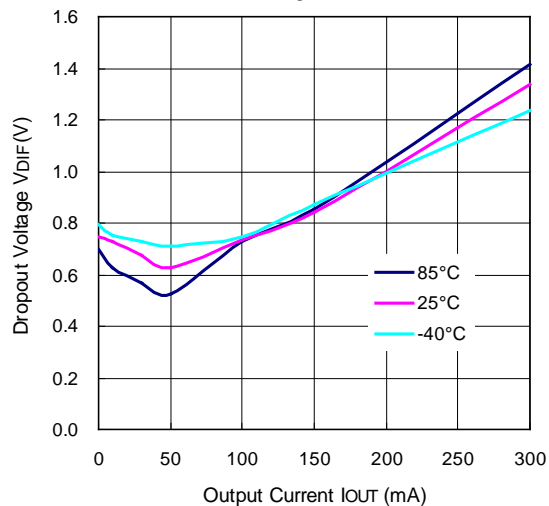

RP170x30xx

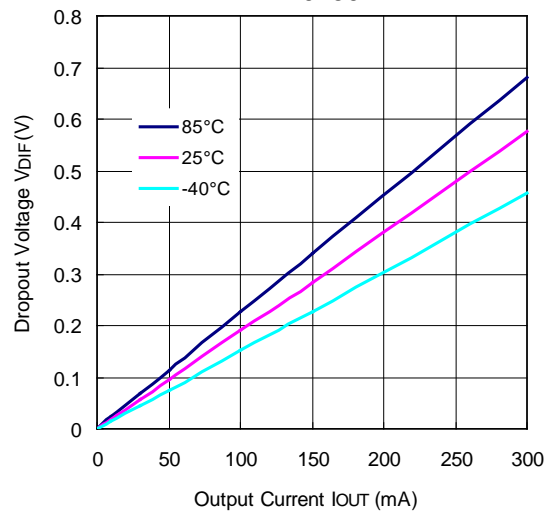

RP170x-Y

NO. EA-341-160613

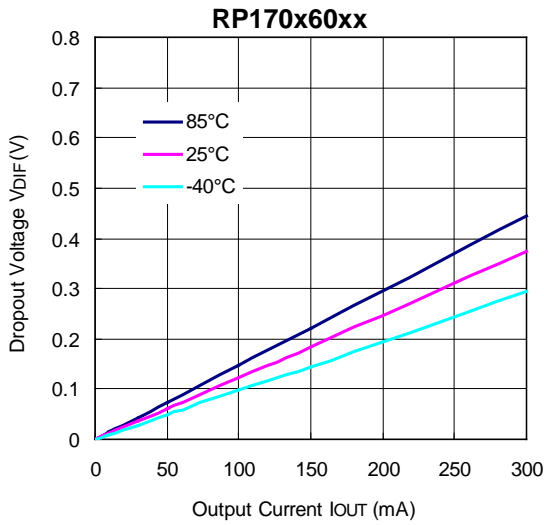

8) Dropout Voltage vs. Set Output Voltage ($T_a = 25^\circ\text{C}$)

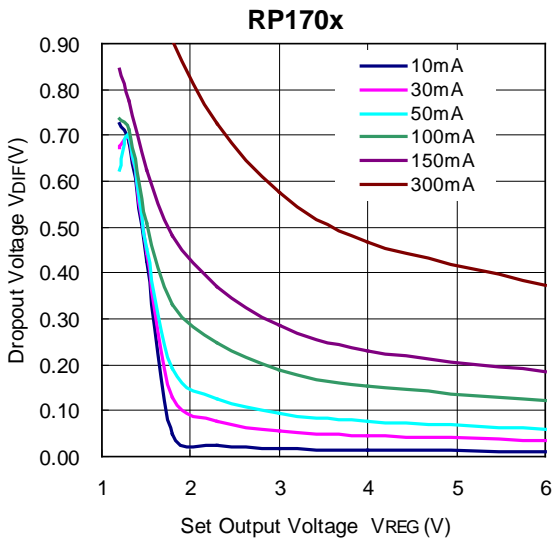

9) Minimum Operating Voltage

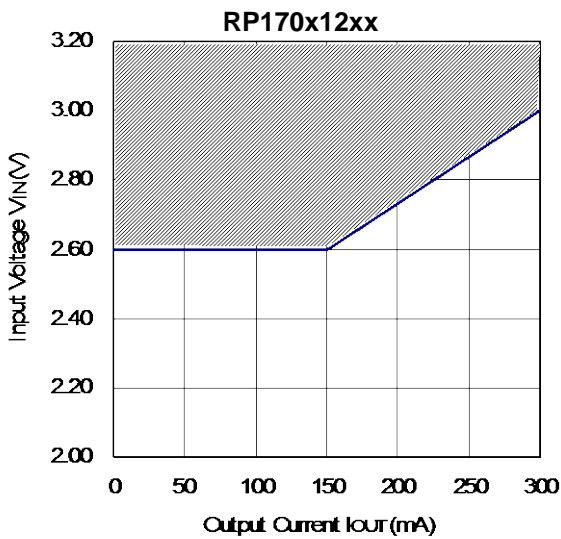

Hatched area is available for 1.2 V output

10) Ripple Rejection vs. Input Bias Voltage (C1 = none, C2 = Ceramic 1.0 μ F, Ripple = 0.2 Vp-p, Ta = 25°C)

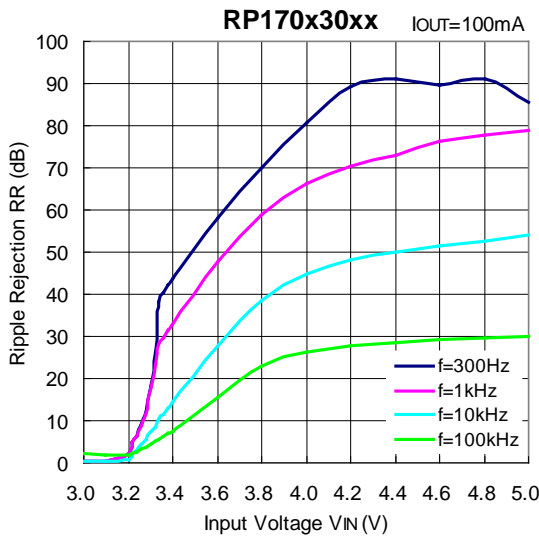
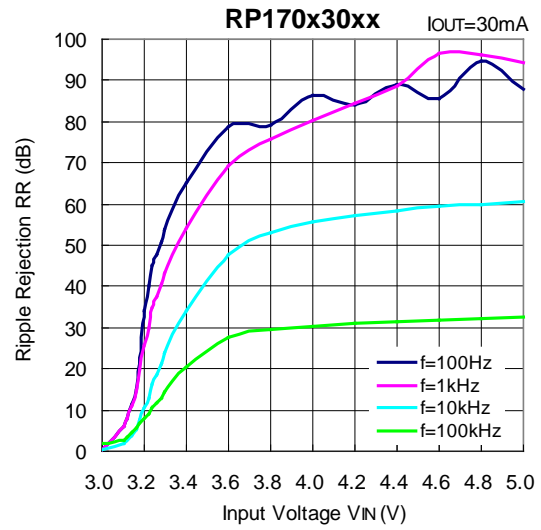
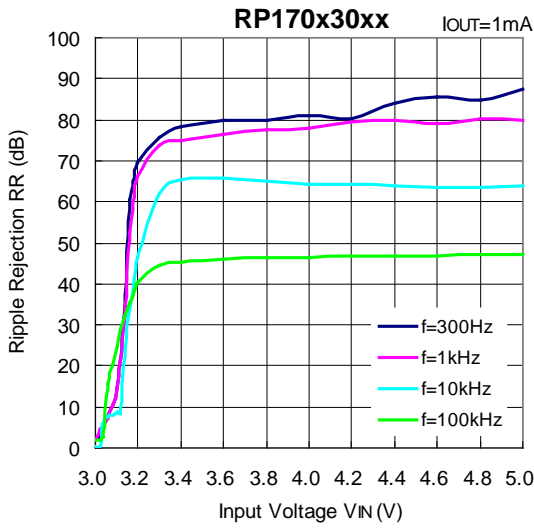

11) Ripple Rejection vs. Frequency (C1 = none, C2 = Ceramic 1.0 μ F, Ta = 25°C)

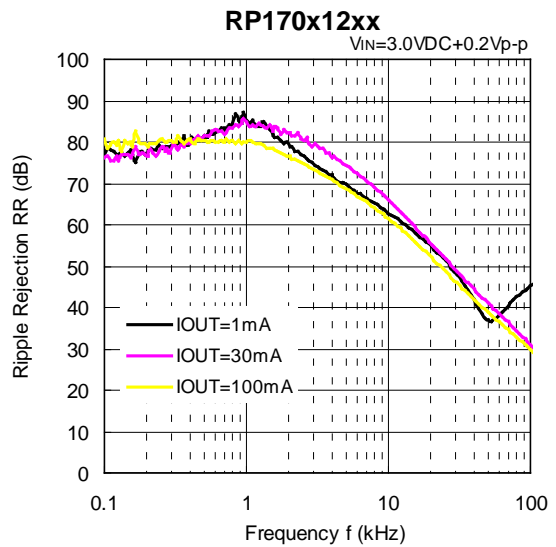
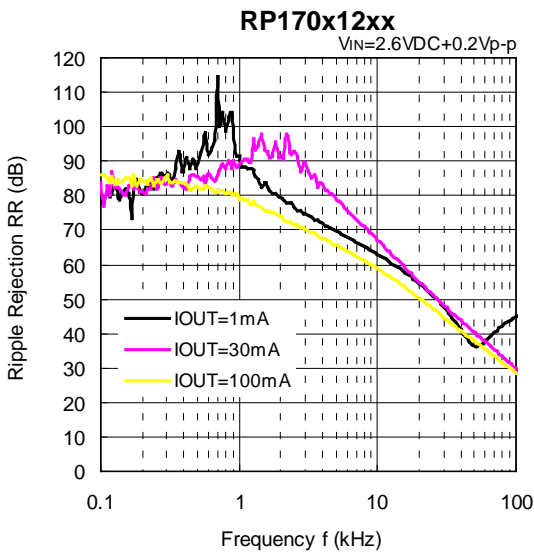

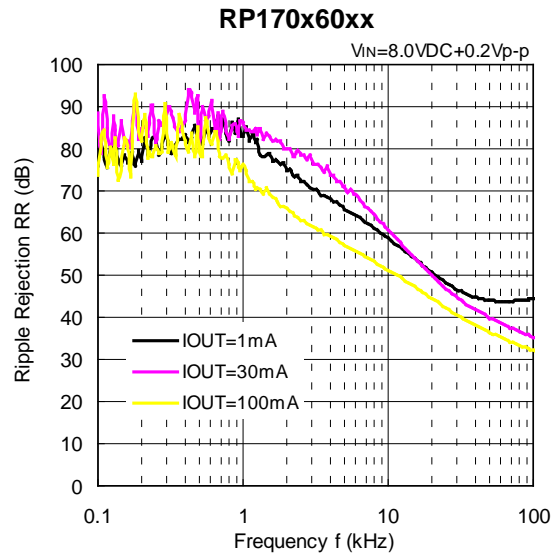
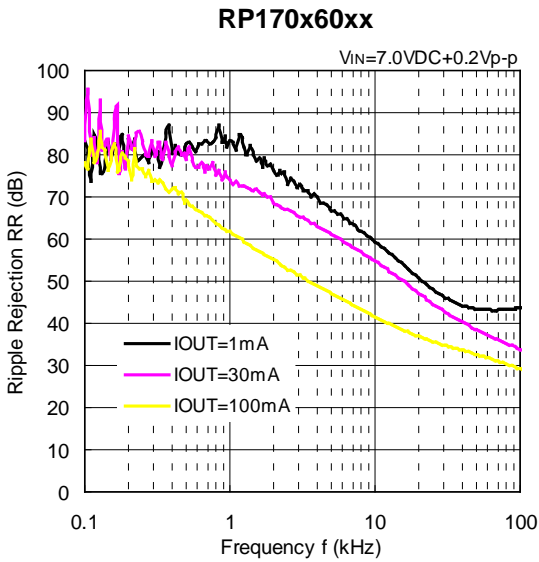
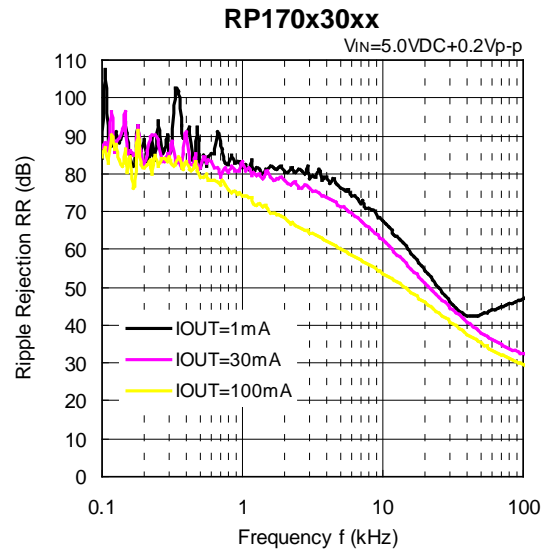
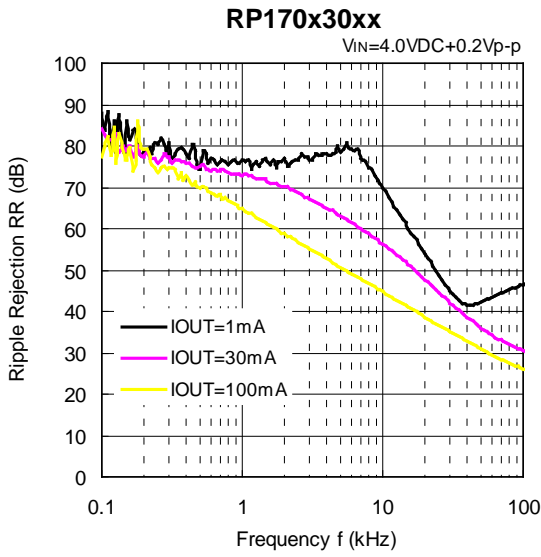

12) Input Transient Response (C1 = none, IOUT = 30 mA, tr = tf = 5 μs, Ta = 25°C)

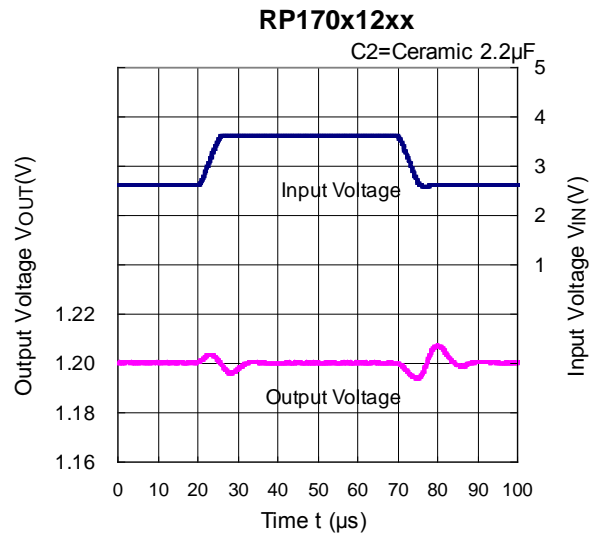
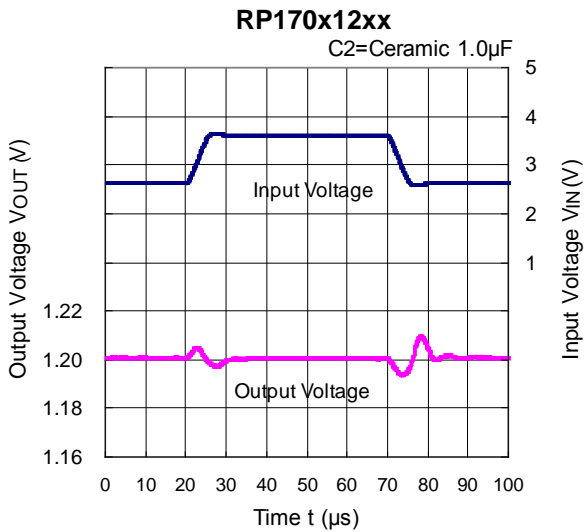

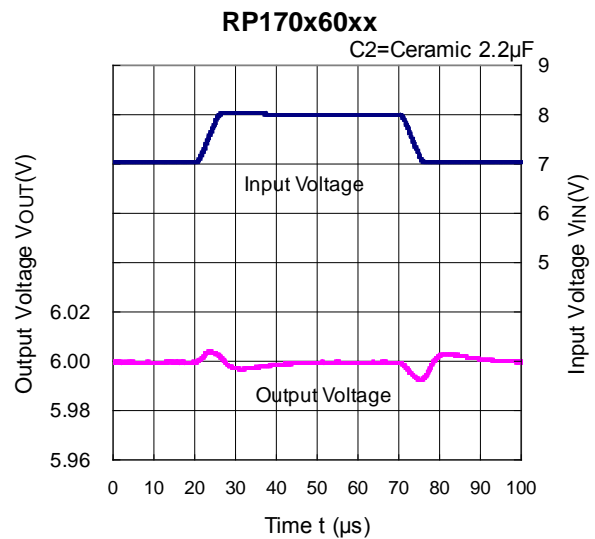
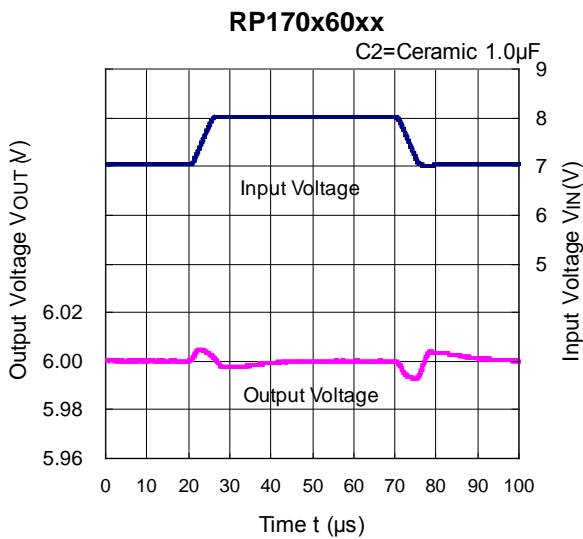
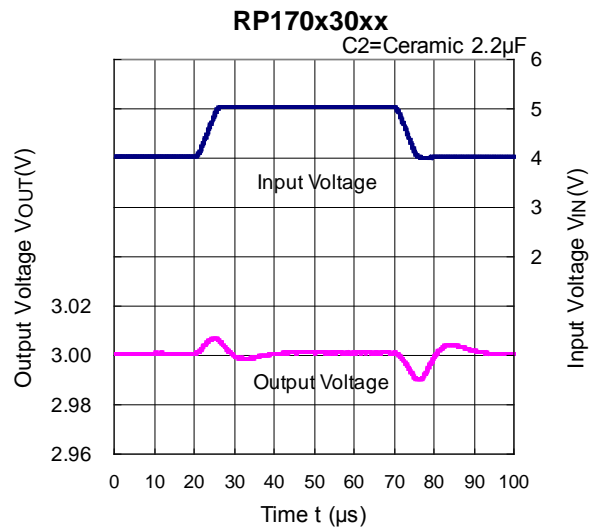
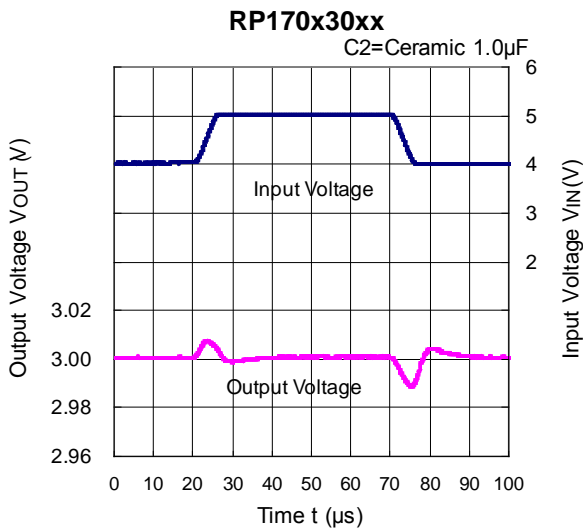

13) Load Transient Response (C1 = Ceramic 1.0 μ F, $t_r = t_f = 500$ ns, $T_a = 25^\circ C$)

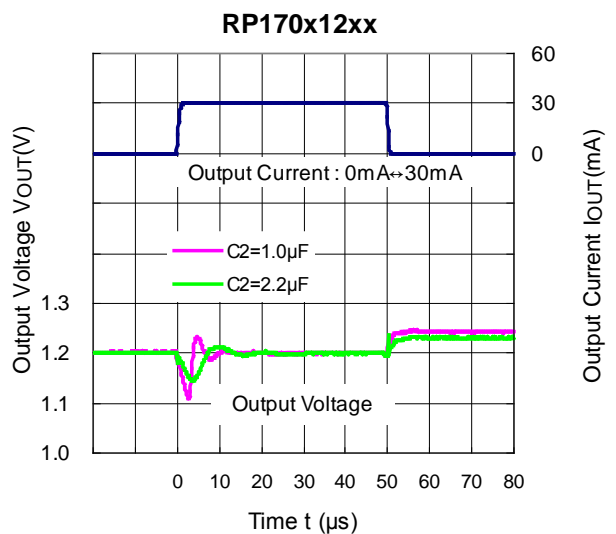
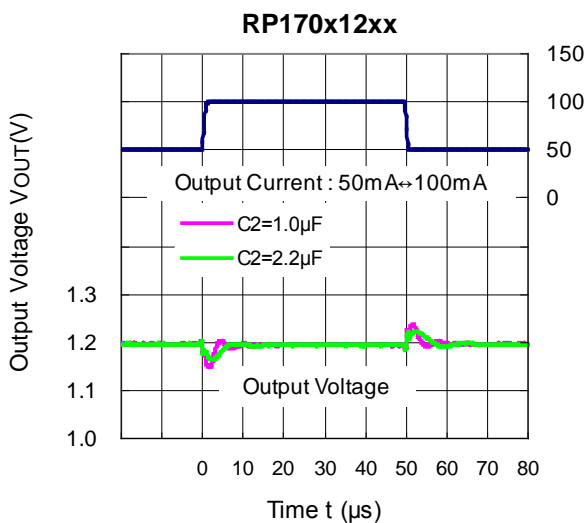

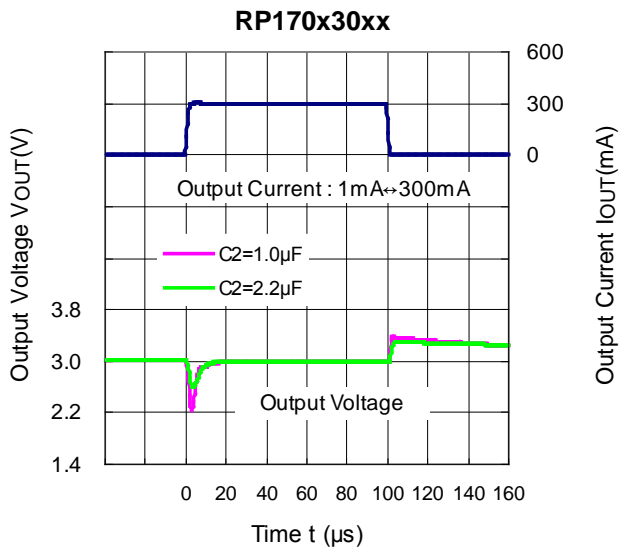
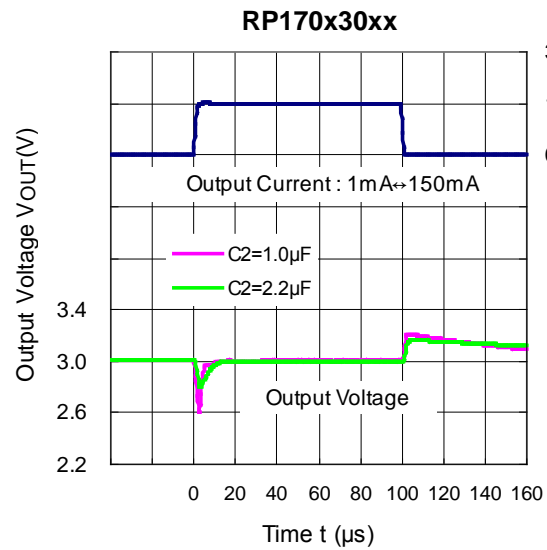
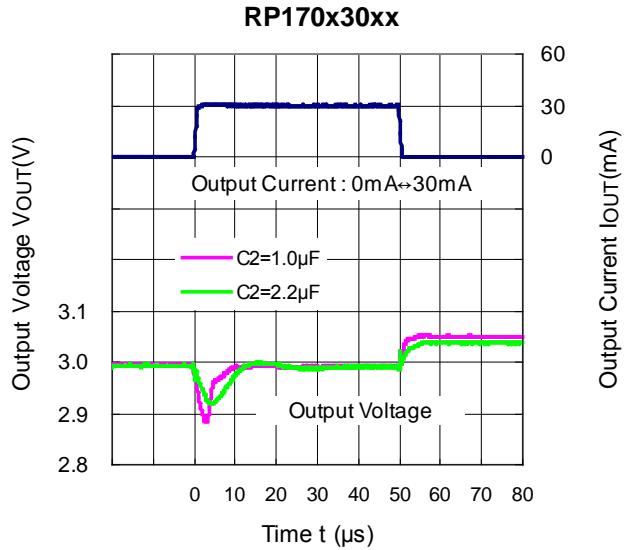
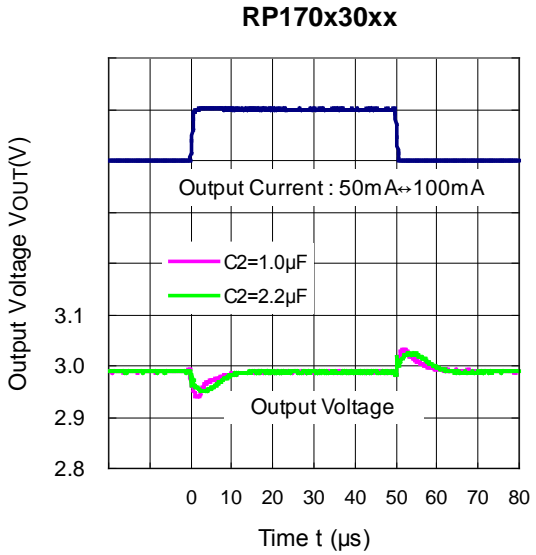
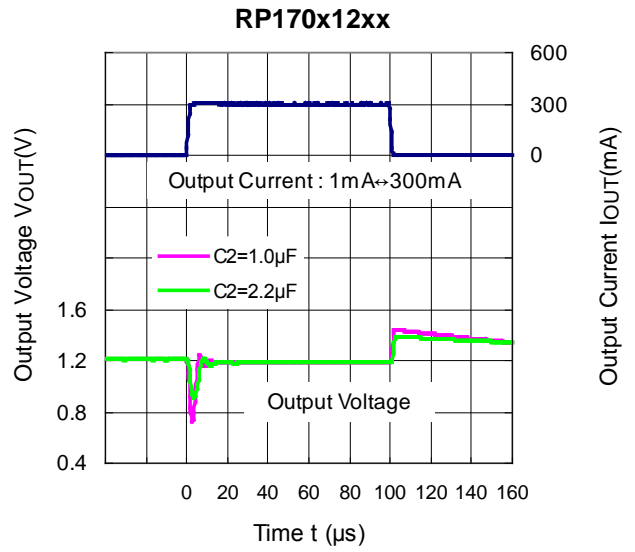
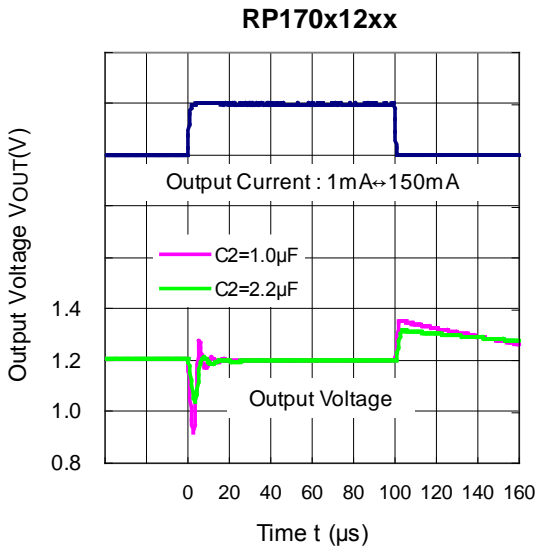

RP170x60xx

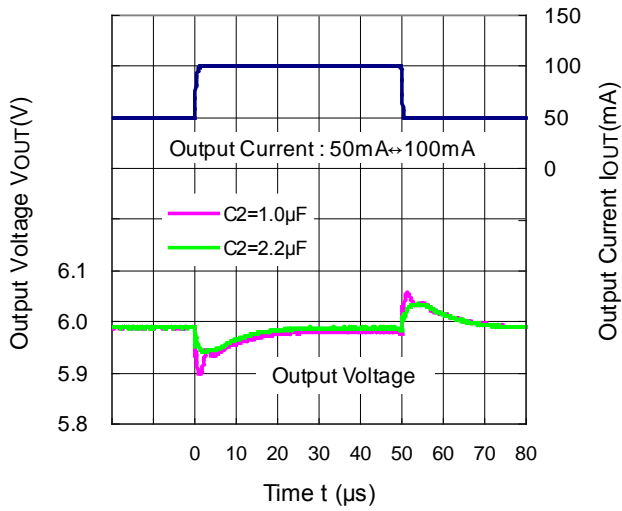

RP170x60xx

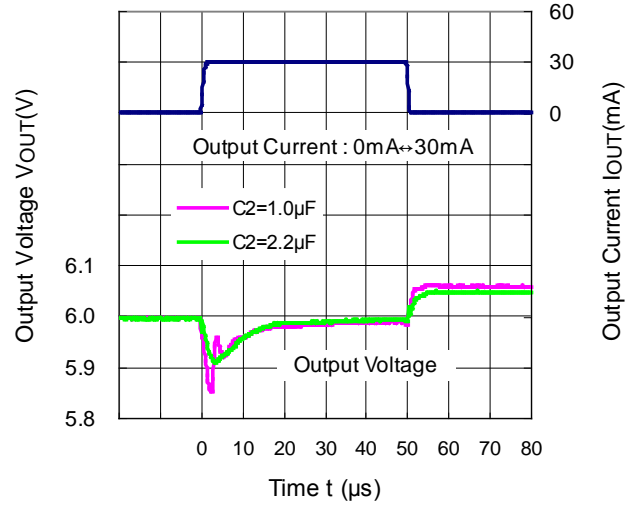

RP170x60xx

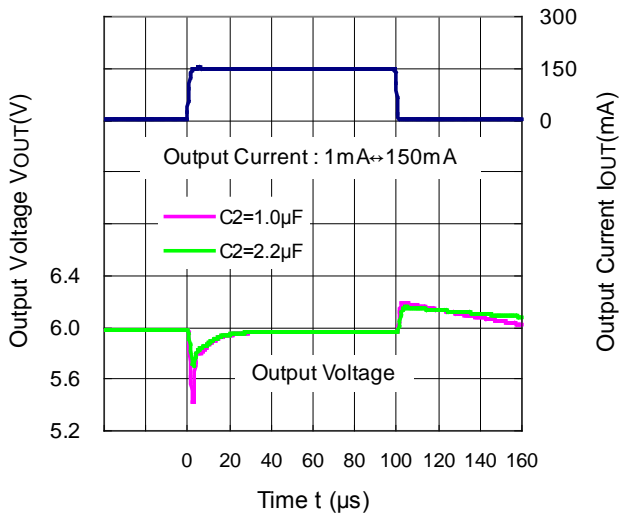

RP170x60xx

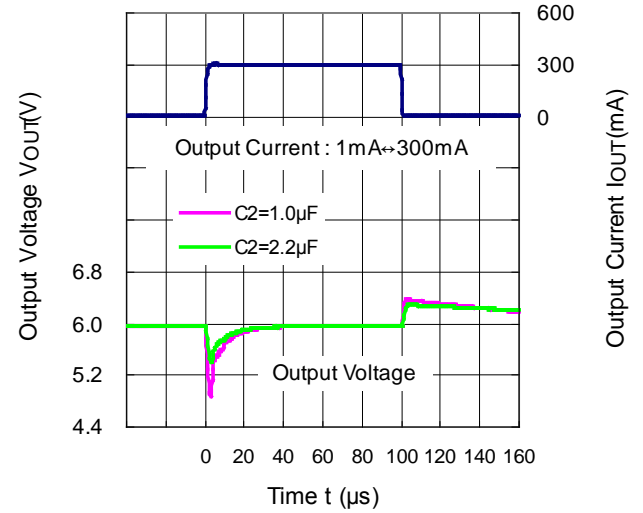

14) Turn On Speed with CE pin (C1 = Ceramic 1.0 μ F, Ta = 25°C)

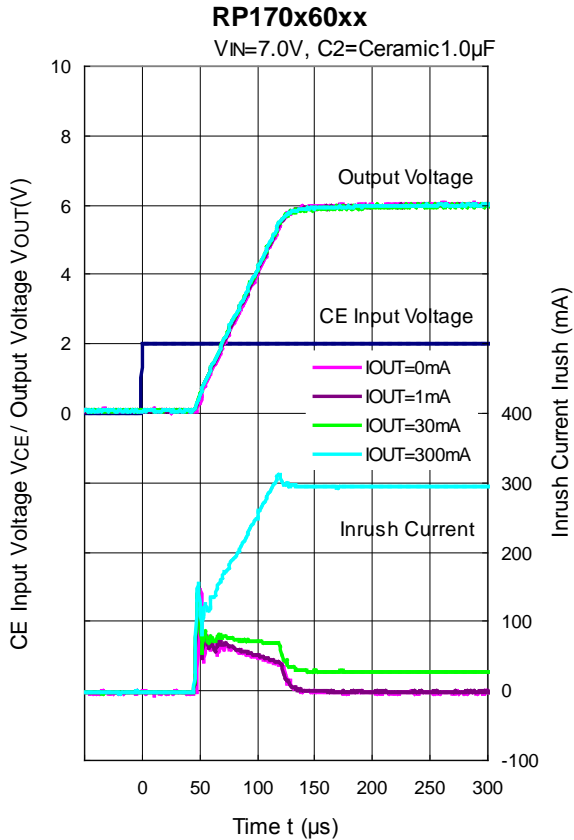
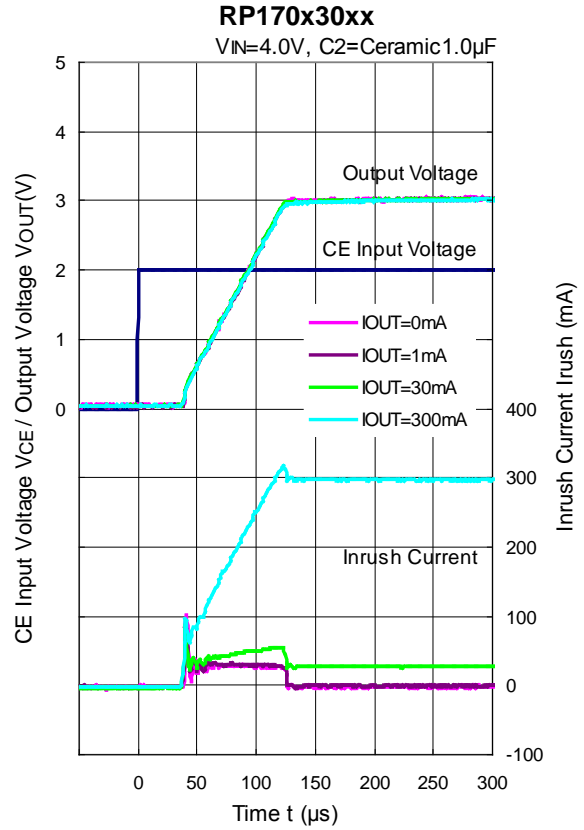
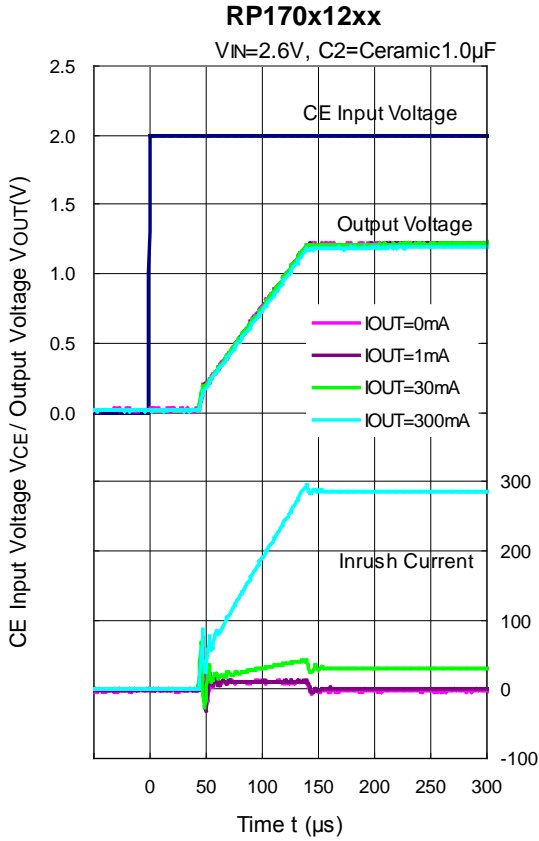

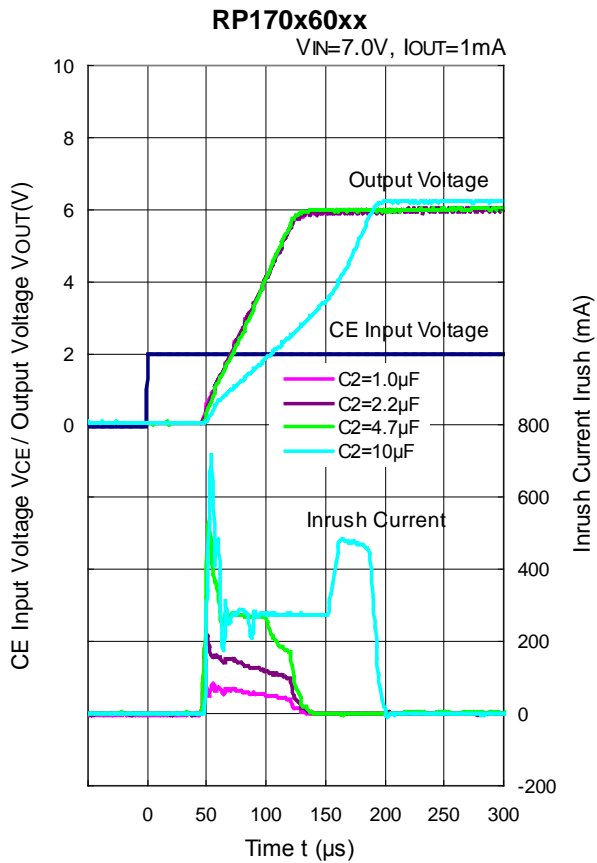
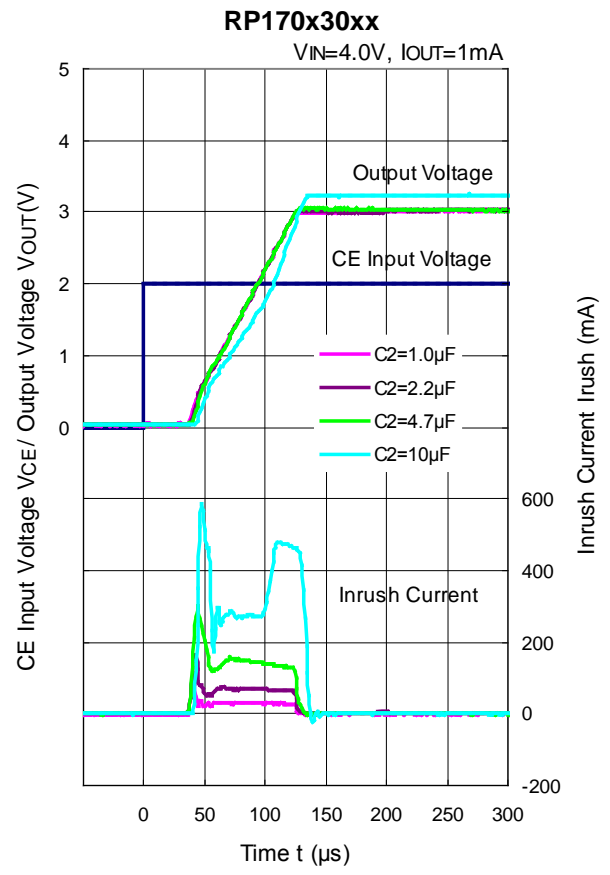
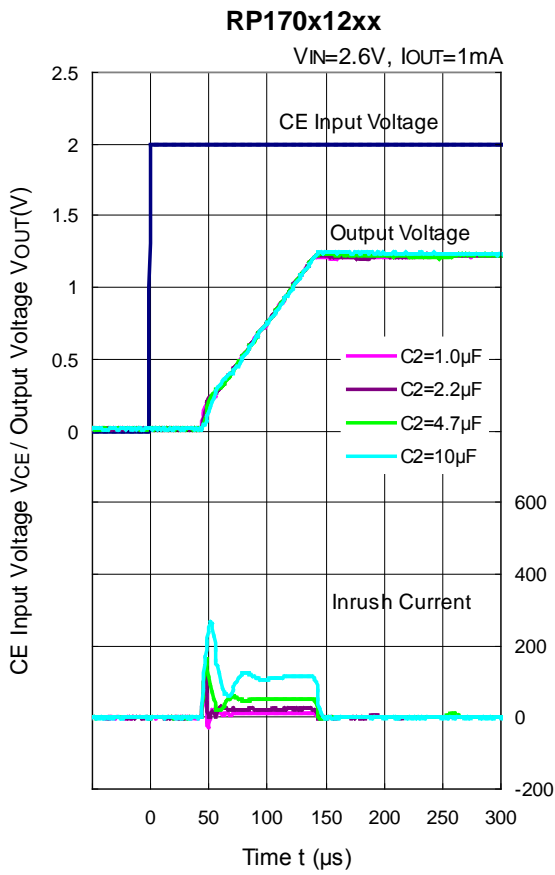

RP170x-Y

NO. EA-341-160613

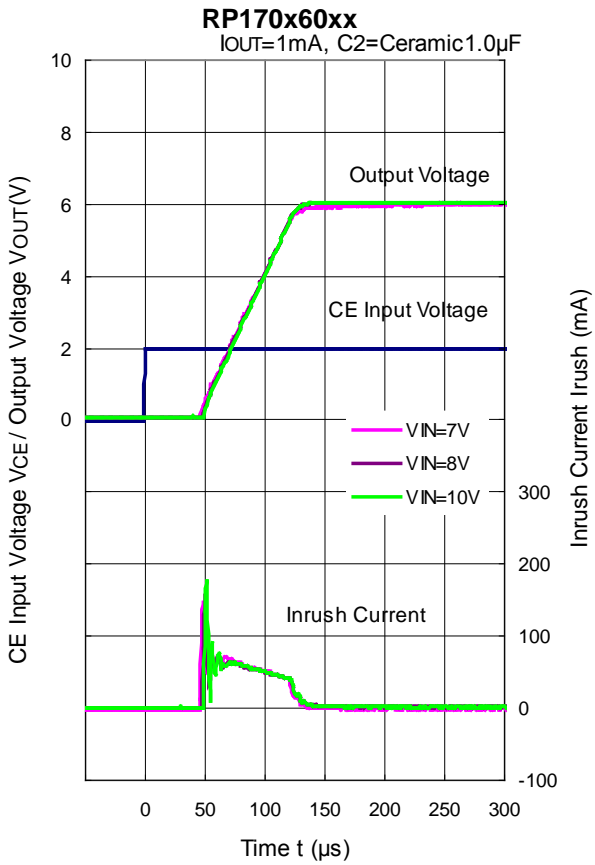
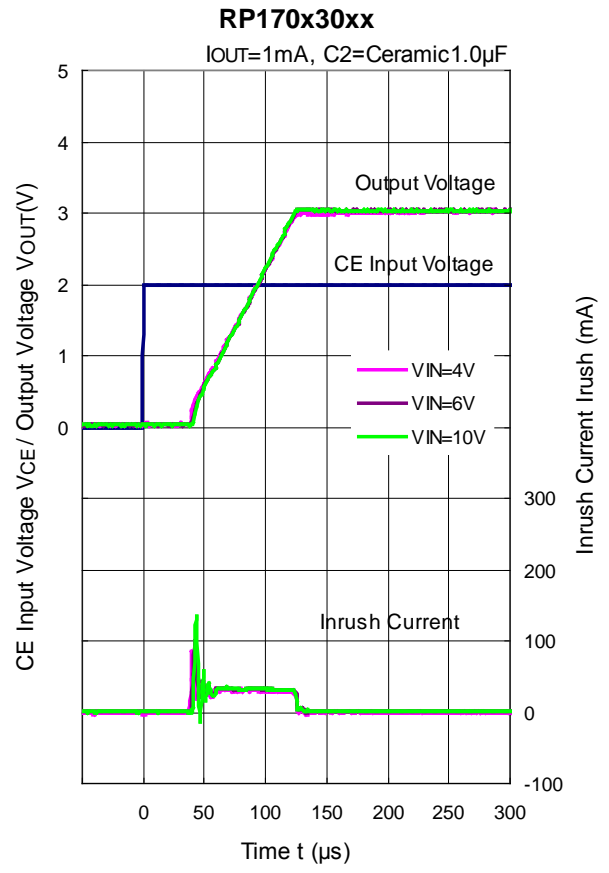
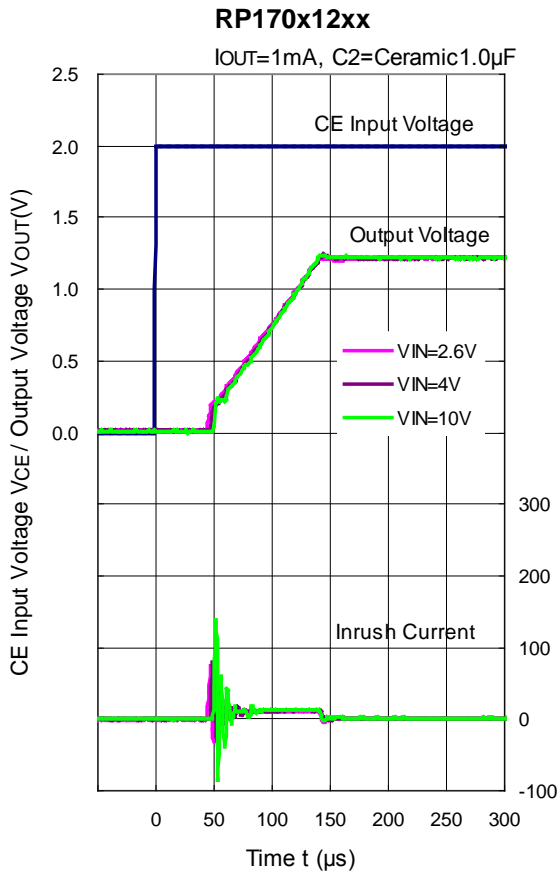

15) Turn Off Speed with CE pin (D Version) (C1 = Ceramic 1.0 μ F, Ta = 25°C)

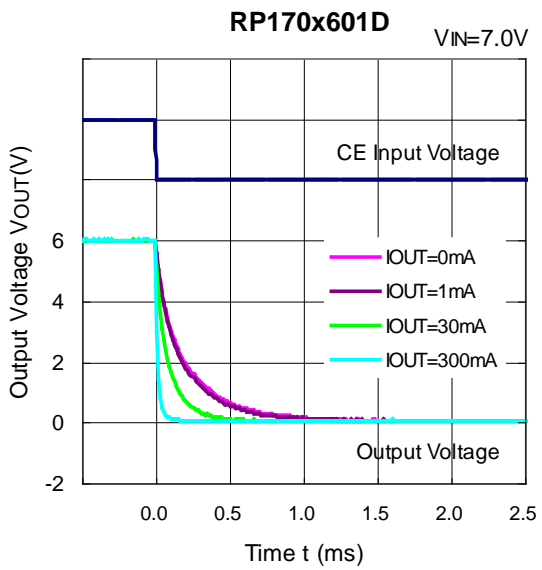
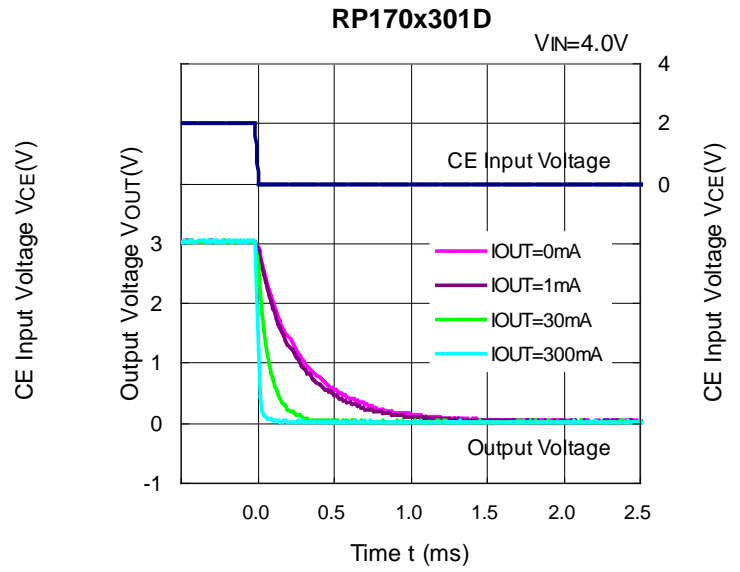
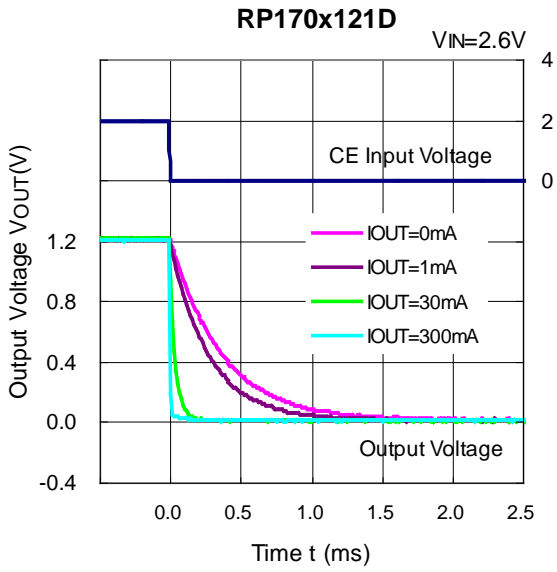

ESR vs. Output Current

Ceramic type output capacitor is recommended for this series; however, the other output capacitors with low ESR also can be used. The relations between I_{OUT} (Output Current) and ESR of an output capacitor are shown below. The conditions when the white noise level is under $40 \mu V$ (Avg.) are marked as the hatched area in the graph.

Measurement conditions

Frequency Band : 10 Hz to 2 MHz

Temperature : $-40^{\circ}C$ to $85^{\circ}C$

C1, C2 : Ceramic $1.0 \mu F$ (Murata GRM155B31A105KE)

RP170x12xx

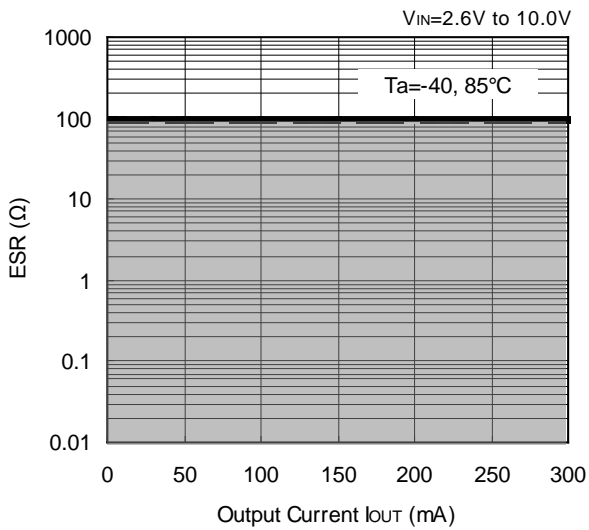

RP170x30xx

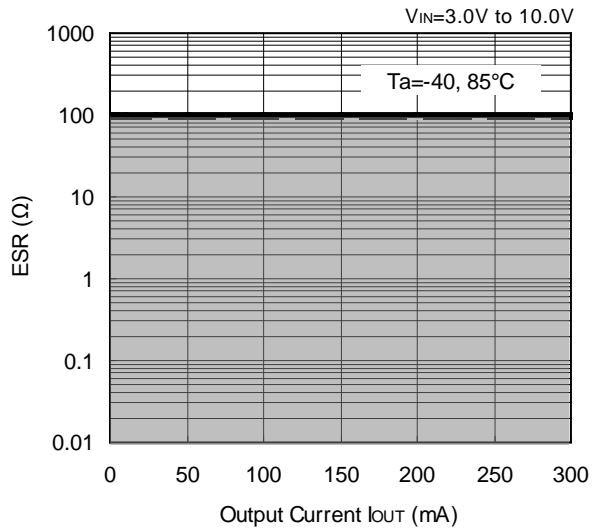

RP170x60xx

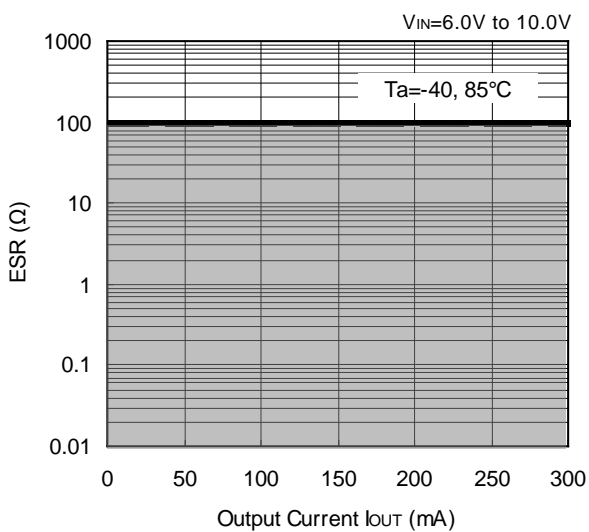



1. The products and the product specifications described in this document are subject to change or discontinuation of production without notice for reasons such as improvement. Therefore, before deciding to use the products, please refer to Ricoh sales representatives for the latest information thereon.
2. The materials in this document may not be copied or otherwise reproduced in whole or in part without prior written consent of Ricoh.
3. Please be sure to take any necessary formalities under relevant laws or regulations before exporting or otherwise taking out of your country the products or the technical information described herein.
4. The technical information described in this document shows typical characteristics of and example application circuits for the products. The release of such information is not to be construed as a warranty of or a grant of license under Ricoh's or any third party's intellectual property rights or any other rights.
5. The products listed in this document are intended and designed for use as general electronic components in standard applications (office equipment, telecommunication equipment, measuring instruments, consumer electronic products, amusement equipment etc.). Those customers intending to use a product in an application requiring extreme quality and reliability, for example, in a highly specific application where the failure or misoperation of the product could result in human injury or death (aircraft, spacevehicle, nuclear reactor control system, traffic control system, automotive and transportation equipment, combustion equipment, safety devices, life support system etc.) should first contact us.
6. We are making our continuous effort to improve the quality and reliability of our products, but semiconductor products are likely to fail with certain probability. In order to prevent any injury to persons or damages to property resulting from such failure, customers should be careful enough to incorporate safety measures in their design, such as redundancy feature, fire containment feature and fail-safe feature. We do not assume any liability or responsibility for any loss or damage arising from misuse or inappropriate use of the products.
7. Anti-radiation design is not implemented in the products described in this document.
8. The X-ray exposure can influence functions and characteristics of the products. Confirm the product functions and characteristics in the evaluation stage.
9. WLCSP products should be used in light shielded environments. The light exposure can influence functions and characteristics of the products under operation or storage.
10. There can be variation in the marking when different AOI (Automated Optical Inspection) equipment is used. In the case of recognizing the marking characteristic with AOI, please contact Ricoh sales or our distributor before attempting to use AOI.
11. Please contact Ricoh sales representatives should you have any questions or comments concerning the products or the technical information.



Ricoh is committed to reducing the environmental loading materials in electrical devices with a view to contributing to the protection of human health and the environment.

Ricoh has been providing RoHS compliant products since April 1, 2006 and Halogen-free products since April 1, 2012.

RICOH RICOH ELECTRONIC DEVICES CO., LTD.

<https://www.e-devices.ricoh.co.jp/en/>

Sales & Support Offices

Ricoh Electronic Devices Co., Ltd.

Shin-Yokohama Office (International Sales)

2-3, Shin-Yokohama 3-chome, Kohoku-ku, Yokohama-shi, Kanagawa, 222-8530, Japan
Phone: +81-50-3814-7687 Fax: +81-45-474-0074

Ricoh Americas Holdings, Inc.

675 Campbell Technology Parkway, Suite 200 Campbell, CA 95008, U.S.A.
Phone: +1-408-610-3105

Ricoh Europe (Netherlands) B.V.

Semiconductor Support Centre

Prof. W.H. Keesomlaan 1, 1183 DJ Amstelveen, The Netherlands
Phone: +31-20-5474-309

Ricoh International B.V. - German Branch

Semiconductor Sales and Support Centre

Oberrather Strasse 6, 40472 Düsseldorf, Germany
Phone: +49-211-6546-0

Ricoh Electronic Devices Korea Co., Ltd.

3F, Haesung Bldg, 504, Teheran-ro, Gangnam-gu, Seoul, 135-725, Korea
Phone: +82-2-2135-5700 Fax: +82-2-2051-5713

Ricoh Electronic Devices Shanghai Co., Ltd.

Room 403, No.2 Building, No.690 Bibo Road, Pu Dong New District, Shanghai 201203,
People's Republic of China
Phone: +86-21-5027-3200 Fax: +86-21-5027-3299

Ricoh Electronic Devices Shanghai Co., Ltd.

Shenzhen Branch

1205, Block D (Jinlong Building), Kingkey 100, Hongbao Road, Luohu District,
Shenzhen, China
Phone: +86-755-8348-7600 Ext 225

Ricoh Electronic Devices Co., Ltd.

Taipei office

Room 109, 10F-1, No.51, Hengyang Rd., Taipei City, Taiwan (R.O.C.)
Phone: +886-2-2313-1621/1622 Fax: +886-2-2313-1623

X-ON Electronics

Largest Supplier of Electrical and Electronic Components

Click to view similar products for [LDO Voltage Regulators](#) category:

Click to view products by [Nisshinbo](#) manufacturer:

Other Similar products are found below :

[AP7363-SP-13](#) [L79M05TL-E](#) [PT7M8202B12TA5EX](#) [TCR3DF185,LM\(CT](#) [TCR3DF24,LM\(CT](#) [TCR3DF285,LM\(CT](#) [TCR3DF31,LM\(CT](#)
[TCR3DF45,LM\(CT](#) [MP2013GQ-33-Z](#) [059985X](#) [NCP4687DH15T1G](#) [701326R](#) [TCR2EN28,LF\(S](#) [NCV8170AXV250T2G](#)
[TCR3DF27,LM\(CT](#) [TCR3DF19,LM\(CT](#) [TCR3DF125,LM\(CT](#) [TCR2EN18,LF\(S](#) [AP2112R5A-3.3TRG1](#) [AP7315-25W5-7](#)
[IFX30081LDVGRNXUMA1](#) [NCV47411PAAJR2G](#) [AP2113KTR-G1](#) [AP2111H-1.2TRG1](#) [ZLDO1117QK50TC](#) [AZ1117IH-1.8TRG1](#)
[AZ1117ID-ADJTRG1](#) [TCR3DG12,LF](#) [MIC5514-3.3YMT-T5](#) [MIC5512-1.2YMT-T5](#) [MIC5317-2.8YM5-T5](#) [SCD7912BTG](#)
[NCP154MX180270TAG](#) [SCD33269T-5.0G](#) [NCV8170BMX330TCG](#) [NCV8170AMX120TCG](#) [NCP706ABMX300TAG](#)
[NCP153MX330180TCG](#) [NCP114BMX075TCG](#) [MC33269T-3.5G](#) [CAT6243-ADJCMT5T](#) [TCR3DG33,LF](#) [AP2127N-1.0TRG1](#)
[TCR4DG35,LF](#) [LT1117CST-3.3](#) [TAR5S15U\(TE85L,F\)](#) [TAR5S18U\(TE85L,F\)](#) [TCR3UG19A,LF](#) [TCR4DG105,LF](#) [NCV8170AMX360TCG](#)