

## Low Power / Fast Mode Alternative 200mA LDO Regulator

NO.EA-279-170710

### OUTLINE

The RP202x is voltage regulator IC with high output voltage accuracy, low dropout voltage and low supply current. This IC performs with the chip enable function and realize a standby mode with low supply current. To prevent the destruction by over current, the current limit circuit is included. The RP202x has 3-mode. One is standby mode with CE pin. The other two are the fast response mode (Fast Mode) and the low power mode, and switch over automatically according to the load current of the LDO. Supply current of IC itself at light load is automatically reduced. The output voltage is maintained between Fast Mode and ECO Mode.

The RP202x consists of a voltage reference unit, an error amplifier, a resistor net for voltage setting, and a current limit circuit.

Since the packages are SOT-23-5, SC-88A, and DFN(PL)1010-4, high density mounting of the IC on boards is possible.

### FEATURES

- Input Voltage Range ..... 1.4V to 5.25V
- Output Voltage Range ..... 0.8V to 4.0V (0.1V steps)
- Supply Current ( $I_{OUT}=0mA$ ) ..... Typ. 2.5 $\mu A$
- Supply Current ( $I_{OUT}=10mA$ )..... Typ. 50 $\mu A$
- Supply Current (Standby Mode)..... Typ. 0.1 $\mu A$
- Dropout Voltage ..... Typ. 0.20V ( $I_{OUT}=200mA$ ,  $V_{OUT}=2.8V$ )
- Ripple Rejection..... Typ. 70dB ( $f=1kHz$ ,  $V_{OUT}=2.8V$ ,  $I_{OUT}=30mA$ )
- Line Regulation..... Typ. 0.02%/V ( $I_{OUT}=10mA$ )
- Packages ..... DFN(PL)1010-4, SC-88A, SOT-23-5
- Built-in Foldback Protection Circuit ..... Typ. 60mA (Current at short mode)
- Built-in Constant Slope Circuit (Soft-start Function)
- Ceramic capacitors are recommended to be used with this IC 0.47 $\mu F$  or more

### APPLICATIONS

- Power source for portable communication equipment.
- Power source for electrical appliances such as cameras, VCRs and camcorders.
- Power source for battery-powered equipment.

## RP202x

NO.EA-279-170710

## SELECTION GUIDE

The output voltage, auto discharge function<sup>(1)</sup>, and package, for the IC can be selected at the user's request.

Product Name	Package	Quantity per Reel	Pb Free	Halogen Free
RP202Kxx1*-TR	DFN(PL)1010-4	10,000pcs	Yes	Yes
RP202Qxx2*-TR-FE	SC-88A	3,000pcs	Yes	Yes
RP202Nxx1*-TR-FE	SOT-23-5	3,000pcs	Yes	Yes

xx: The output voltage can be designated in the range from 0.8V(08) to 4.0V(40) in 0.1V steps.

\* : The auto discharge function at off state are options as follows.

(B) without auto discharge function at off state

(D) with auto discharge function at off state

## BLOCK DIAGRAMS

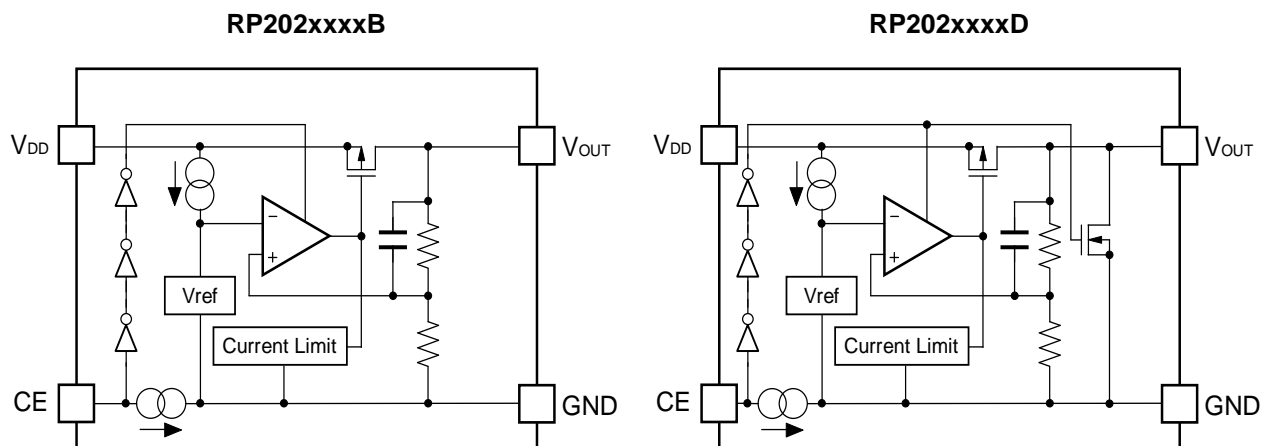

<sup>(1)</sup> Auto-discharge function quickly lowers the output voltage to 0V, when the chip enable signal is switched from the active mode to the standby mode, by releasing the electrical charge accumulated in the external capacitor.

## PIN DESCRIPTIONS

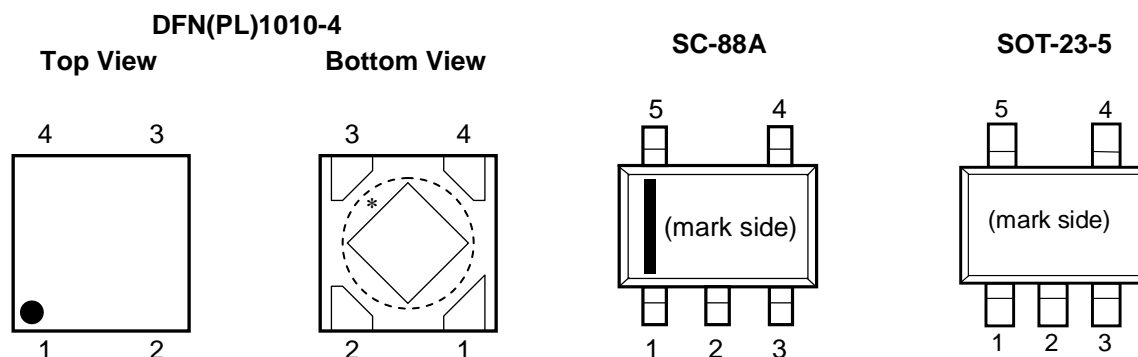

### DFN(PL)1010-4

Pin No	Symbol	Pin Description
1	$V_{OUT}$	Output Pin
2	GND	Ground Pin
3	CE	Chip Enable Pin ("H" Active)
4	$V_{DD}$	Input Pin

\* Tab is GND level. (They are connected to the reverse side of this IC.) The tab is better to be connected to the GND, but leaving it open is also acceptable.

### SC-88A

Pin No	Symbol	Pin Description
1	CE	Chip Enable Pin ("H" Active)
2 <sup>(1)</sup>	NC	No Connection
3	GND	Ground Pin
4	$V_{OUT}$	Output Pin
5	$V_{DD}$	Input Pin

### SOT-23-5

Pin No	Symbol	Pin Description
1	$V_{DD}$	Input Pin
2	GND	Ground Pin
3	CE	Chip Enable Pin ("H" Active)
4	NC	No Connection
5	$V_{OUT}$	Output Pin

<sup>(1)</sup> Pin No. 2 is connected to the bottom of the IC. It is recommended that the pin be connected to the ground plane on the board, or otherwise be left floating so that there is no contact with other potentials.

## RP202x

NO.EA-279-170710

### ABSOLUTE MAXIMUM RATINGS

Symbol	Item	Rating	Unit
V <sub>IN</sub>	Input Voltage	6.0	V
V <sub>CE</sub>	Input Voltage (CE Pin)	-0.3 to 6.0	V
V <sub>OUT</sub>	Output Voltage	-0.3 to V <sub>IN</sub> + 0.3	V
I <sub>OUT</sub>	Output Current	220	mA
P <sub>D</sub>	Power Dissipation (DFN(PL)1010-4, Standard Test Land Pattern) <sup>1</sup>	400	mW
	Power Dissipation (SC-88A, Standard Test Land Pattern) <sup>1</sup>	380	
	Power Dissipation (SOT-23-5, Standard Test Land Pattern) <sup>1</sup>	420	
T <sub>j</sub>	Junction Temperature Range	-40 to 125	°C
T <sub>stg</sub>	Storage Temperature Range	-55 to 125	°C

#### ABSOLUTE MAXIMUM RATINGS

Electronic and mechanical stress momentarily exceeded absolute maximum ratings may cause the permanent damages and may degrade the life time and safety for both device and system using the device in the field. The functional operation at or over these absolute maximum ratings is not assured.

### RECOMMENDED OPERATING CONDITIONS

Symbol	Item	Rating	Unit
V <sub>IN</sub>	Input Voltage	1.4 to 5.25	V
T <sub>a</sub>	Operating Temperature Range	-40 to 85	°C

#### RECOMMENDED OPERATING CONDITIONS

All of electronic equipment should be designed that the mounted semiconductor devices operate within the recommended operating conditions. The semiconductor devices cannot operate normally over the recommended operating conditions, even if when they are used over such conditions by momentary electronic noise or surge. And the semiconductor devices may receive serious damage when they continue to operate over the recommended operating conditions.

<sup>(1)</sup> Refer to *POWER DISSIPATION* for detailed information.

## ELECTRICAL CHARACTERISTICS

$V_{IN}$ =Set  $V_{OUT}+1V$ ,  $I_{OUT}=1mA$ ,  $C_{IN}=C_{OUT}=0.47\mu F$ , unless otherwise noted.

The specification in   is checked and guaranteed by design engineering at  $-40^{\circ}C \leq T_a \leq 85^{\circ}C$ . ( $T_a=25^{\circ}C$ )

Symbol	Item	Conditions	Min.	Typ.	Max.	Unit	
$V_{OUT}$	Output Voltage	$I_{OUT}=5mA$ (Fast Mode) $T_a=25^{\circ}C$	$V_{OUT} > 2.0V$	$\times 0.99$		$\times 1.01$	V
			$V_{OUT} \leq 2.0V$	-20mV		20mV	
		$I_{OUT}=5mA$ (Fast Mode) $-40^{\circ}C \leq T_a \leq 85^{\circ}C$	$V_{OUT} > 2.0V$	<span style="border: 1px solid black; padding: 0 2px;"><math>\times 0.965</math></span>		<span style="border: 1px solid black; padding: 0 2px;"><math>\times 1.025</math></span>	
			$V_{OUT} \leq 2.0V$	<span style="border: 1px solid black; padding: 0 2px;"><math>-70mV</math></span>		<span style="border: 1px solid black; padding: 0 2px;"><math>50mV</math></span>	
$I_{OUT}$	Output Current		<span style="border: 1px solid black; padding: 0 2px;">200</span>			mA	
$\frac{\Delta V_{OUT}}{\Delta I_{OUT}}$	Load Regulation	$1mA \leq I_{OUT} \leq 10mA$	$V_{OUT} > 2.0V$	-1.0		1.0	%
			$V_{OUT} \leq 2.0V$	-20		20	mV
		$10mA \leq I_{OUT} \leq 200mA$		<span style="border: 1px solid black; padding: 0 2px;"><math>-20</math></span>	10	<span style="border: 1px solid black; padding: 0 2px;">30</span>	mV
$V_{DIF}$	Dropout Voltage	Refer to the "Dropout Voltage"					
$I_{SS1}$	Supply Current ( $I_{OUT}=0mA$ ) <sup>(1)</sup>	$I_{OUT}=0mA$		2.5	<span style="border: 1px solid black; padding: 0 2px;">5.0</span>	$\mu A$	
$I_{SS2}$	Supply Current ( $I_{OUT}=10mA$ )	$I_{OUT}=10mA$		50		$\mu A$	
$I_{standby}$	Standby Current	$V_{CE}=GND$		0.1	1.0	$\mu A$	
$I_{OUTH}$	Fast Mode switch-over current	$I_{OUT}$ = Light load to Heavy load			<span style="border: 1px solid black; padding: 0 2px;">8.0</span>	mA	
$I_{OUTL}$	Low Power Mode switch-over current	$I_{OUT}$ = Heavy load to Light load	<span style="border: 1px solid black; padding: 0 2px;">1.0</span>	2.0		mA	
$\frac{\Delta V_{OUT}}{\Delta V_{IN}}$	Line Regulation	$V_{OUT}+0.5V \leq V_{IN} \leq 5V$ $1.4V \leq V_{IN}$	$I_{OUT}=1mA$ (Low Power Mode)			<span style="border: 1px solid black; padding: 0 2px;"><math>\pm 0.50</math></span>	%V
			$I_{OUT}=10mA$ (Fast Mode)		$\pm 0.02$	<span style="border: 1px solid black; padding: 0 2px;"><math>\pm 0.10</math></span>	
RR	Ripple Rejection	$f=1kHz$ Ripple 0.2Vp-p $V_{IN}=V_{OUT}+1.0V$ , $I_{OUT}=30mA$	$V_{OUT} \leq 1.8V$		75		dB
			$1.8 < V_{OUT} \leq 2.8V$		70		
			$2.8 < V_{OUT} \leq 3.3V$		65		
			$3.3 < V_{OUT}$		60		
$I_{SC}$	Short Current Limit	$V_{OUT}=0V$		60		mA	
$I_{CEPD}$	CE Pull-down Constant Current			0.3	<span style="border: 1px solid black; padding: 0 2px;">0.6</span>	$\mu A$	
$V_{CEH}$	CE Input Voltage "H"		<span style="border: 1px solid black; padding: 0 2px;">1.0</span>			V	
$V_{CEL}$	CE Input Voltage "L"				<span style="border: 1px solid black; padding: 0 2px;">0.4</span>	V	
$R_{LOW}$	Low Output Nch Tr. ON Resistance (of D version)	$V_{IN} = 4.0V$ $V_{CE} = 0V$		60		$\Omega$	

All of units are tested and specified under load conditions such that  $T_j \approx T_a \pm 2.5^{\circ}C$  except for Ripple Rejection, Output Voltage Temperature Coefficient.

<sup>(1)</sup> The value of supply current is excluding the Pull-down constant current of CE Pin.

---

**RP202x**

---

NO.EA-279-170710

**Dropout Voltage**

(Ta=25°C)

Output Voltage $V_{OUT}$ (V)	Dropout Voltage $V_{DIF}$ (V)		
	Condition	Typ.	Max.
$0.8 \leq V_{OUT} < 0.9$	I <sub>OUT</sub> =200mA	0.60	<u>0.79</u>
$0.9 \leq V_{OUT} < 1.0$		0.55	<u>0.73</u>
$1.0 \leq V_{OUT} < 1.1$		0.50	<u>0.64</u>
$1.1 \leq V_{OUT} < 1.2$		0.45	<u>0.61</u>
$1.2 \leq V_{OUT} < 1.3$		0.40	<u>0.56</u>
$1.3 \leq V_{OUT} < 1.4$		0.37	<u>0.53</u>
$1.4 \leq V_{OUT} < 1.5$		0.34	<u>0.48</u>
$1.5 \leq V_{OUT} < 1.8$		0.31	<u>0.43</u>
$1.8 \leq V_{OUT} < 2.1$		0.27	<u>0.39</u>
$2.1 \leq V_{OUT} < 2.5$		0.245	<u>0.36</u>
$2.5 \leq V_{OUT} < 2.8$		0.215	<u>0.31</u>
$2.8 \leq V_{OUT} < 3.0$		0.20	<u>0.29</u>
$3.0 \leq V_{OUT} < 3.3$		0.19	<u>0.28</u>
$3.3 \leq V_{OUT} < 3.6$		0.18	<u>0.27</u>
$3.6 \leq V_{OUT}$		0.175	<u>0.27</u>

## APPLICATION INFORMATION

### TYPICAL APPLICATION

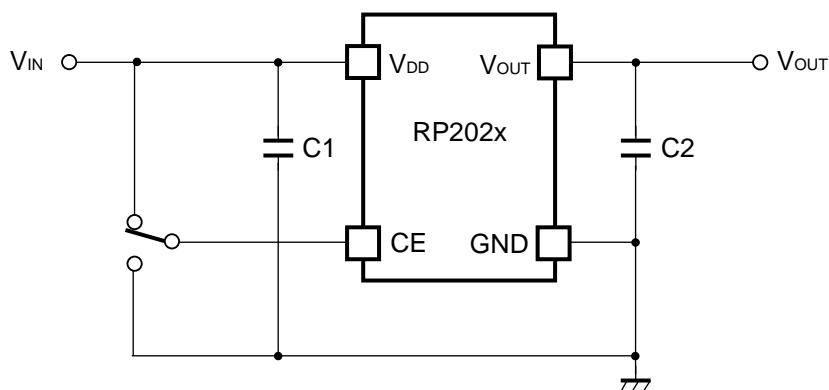

(External Components)

C1, C2 : Ceramic Capacitor 0.47 $\mu$ F MURATA: GRM155B31A474KE14

### Phase Compensation

Phase compensation is made for securing stable operation even if the load current is varied. For this purpose, use a capacitor C2 with 0.47 $\mu$ F or more and good ESR (Equivalent Series Resistance).

(Note: If additional ceramic capacitors are connected with parallel to the output pin with an output capacitor for phase compensation, the operation might be unstable. Because of this, test the IC with as same external components as ones to be used on the PCB.)

### PCB Layout

The impedances of V<sub>DD</sub> line and GND line has to be low as possible. The high impedances may result in the unstable operation or a noise pickup. The output capacitor with 0.47 $\mu$ F or more should be placed between V<sub>DD</sub> and GND. The line from V<sub>DD</sub> to the output capacitor, and the line from the output capacitor to GND must be wired as short as possible.

The output capacitor is placed between V<sub>OUT</sub> and GND as phase compensation. The line from V<sub>OUT</sub> to the output capacitor, and the line from the capacitor to GND must be wired as short as possible. Please refer to the "Basic Test Circuit" below.

---

## RP202x

---

NO.EA-279-170710

### ESR vs. Output Current

When using the IC, consider the following points:

The relations between  $I_{OUT}$  (Output Current) and ESR of an output capacitor are shown below.

The conditions when the white noise level is under  $40\mu\text{V}$  (Avg.) are marked as the hatched area in the graph.

#### Measurement conditions

Frequency Band : 10Hz to 2MHz

Temperature :  $-40^{\circ}\text{C}$  to  $85^{\circ}\text{C}$

C1, C2 :  $0.47\mu\text{F}$

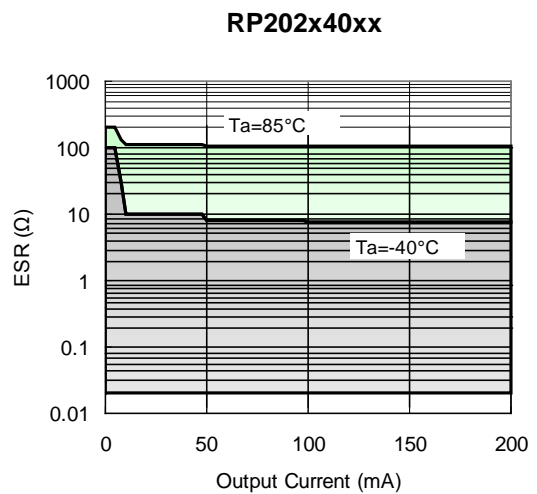
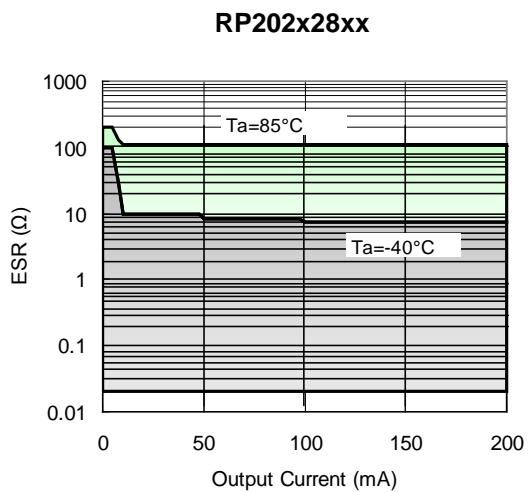
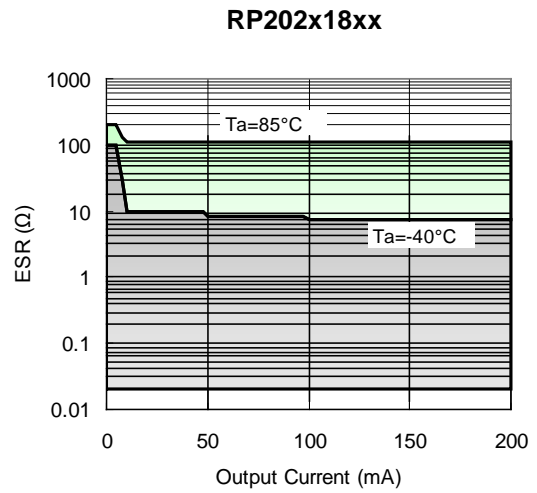
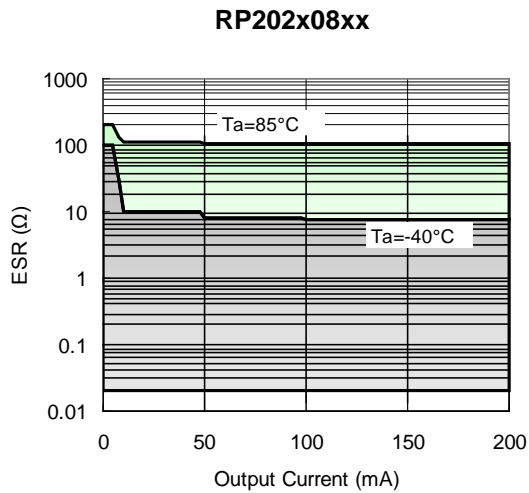



## TYPICAL CHARACTERISTICS

### 1) Output Voltage vs. Output Current (C1=0.47μF, C2=0.47μF, Ta=25°C)

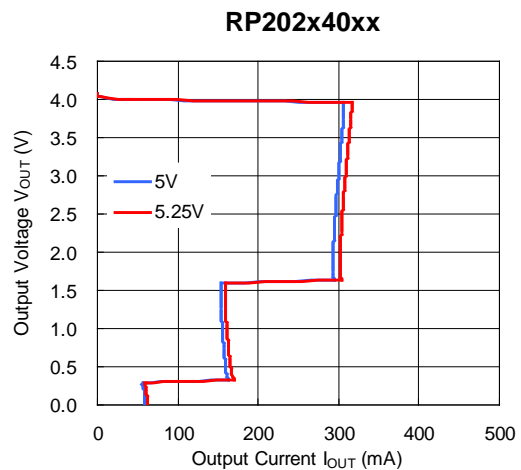
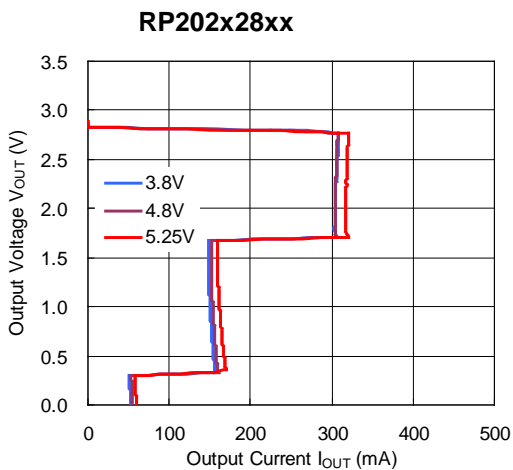
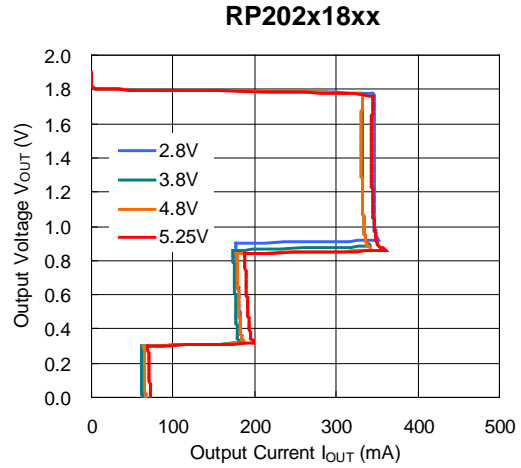
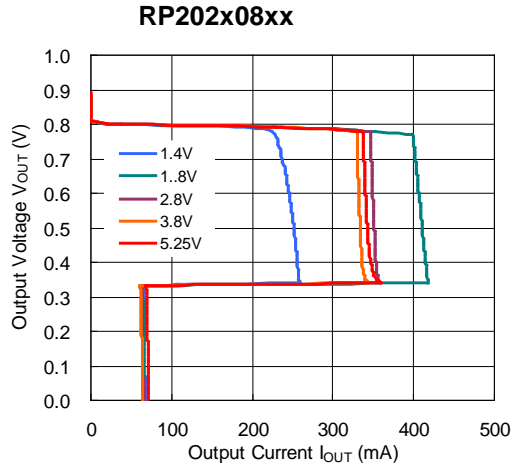

### 2) Output Voltage vs. Input Voltage (C1=0.47μF, C2=0.47μF, Ta=25°C)

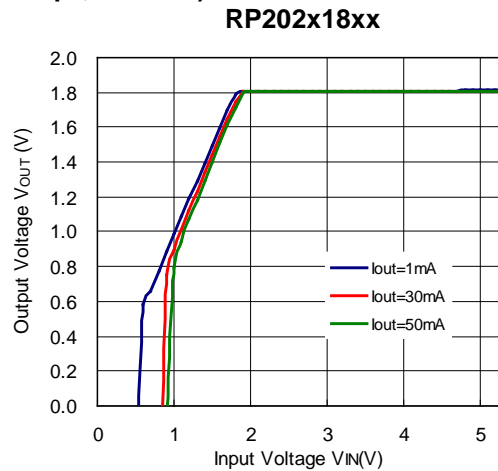
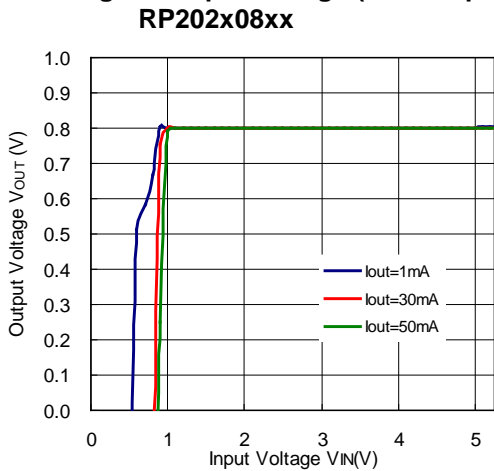

# RP202x

NO.EA-279-170710

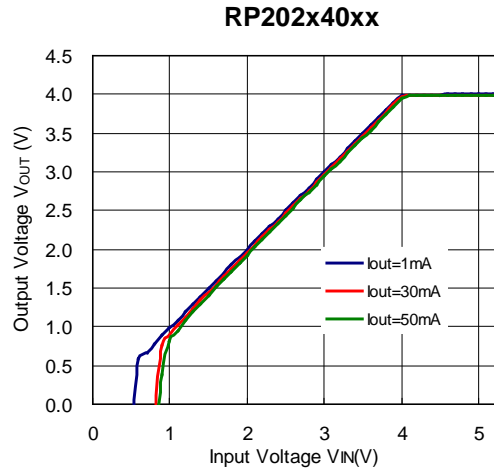
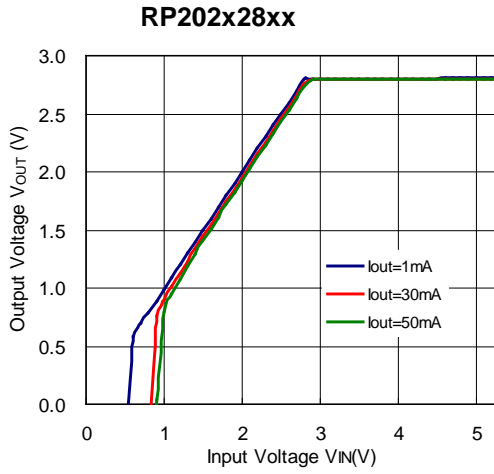

### 3) Supply Current vs. Input Voltage ( $C1=0.47\mu F$ , $C2=0.47\mu F$ , $T_a=25^\circ C$ )

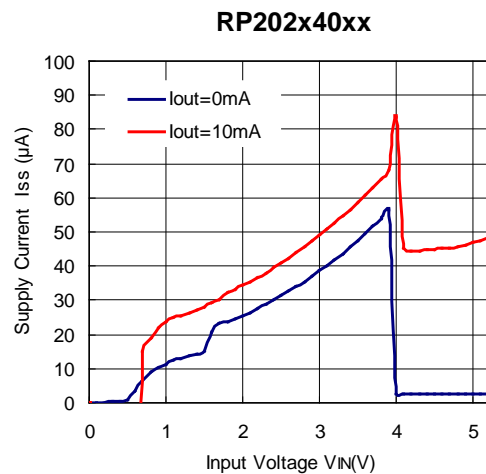
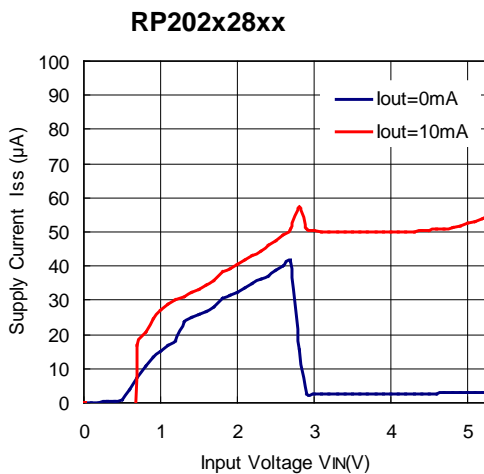
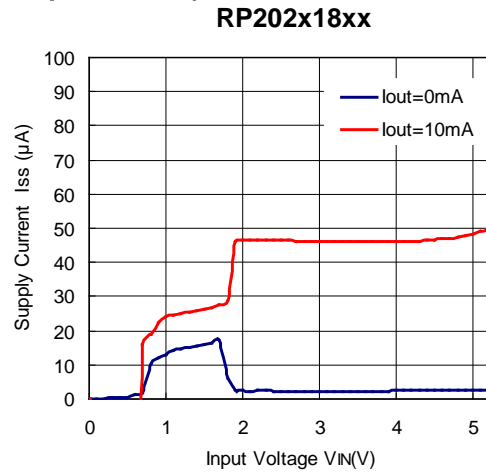
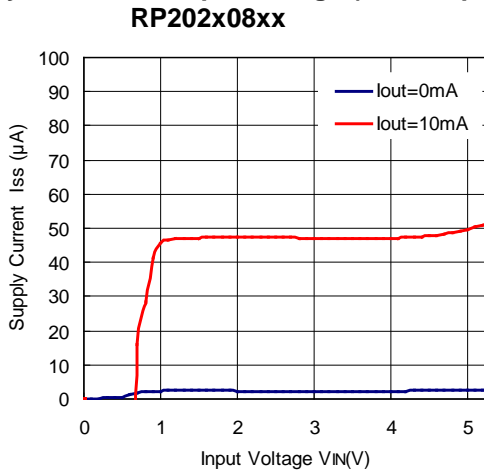

4) Supply Current vs. Output Current (C1=0.47μF, C2=0.47μF, Ta=25°C)

RP202x08xx

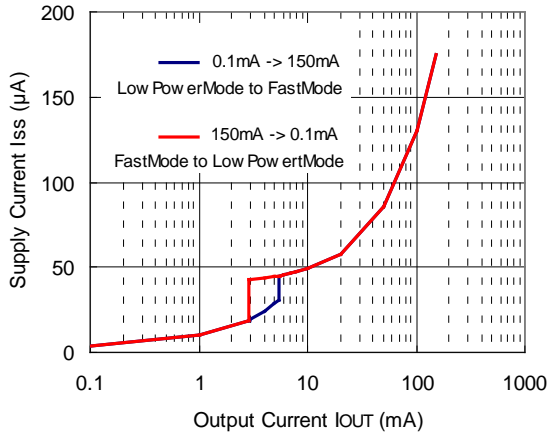

RP202x18xx

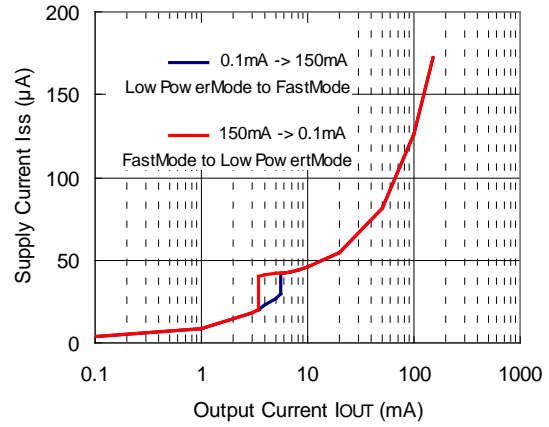

RP202x28xx

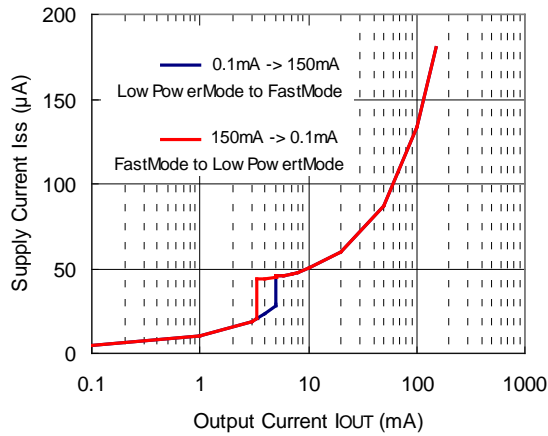

RP202x40xx

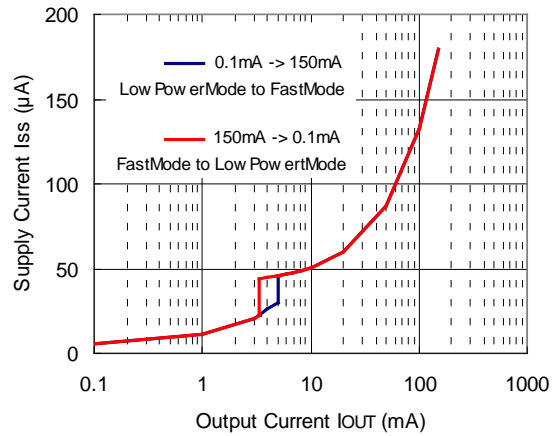

5) Output Voltage vs. Temperature (C1=0.47μF, C2=0.47μF, IOUT=1mA)

RP202x08xx

VIN=1.8V

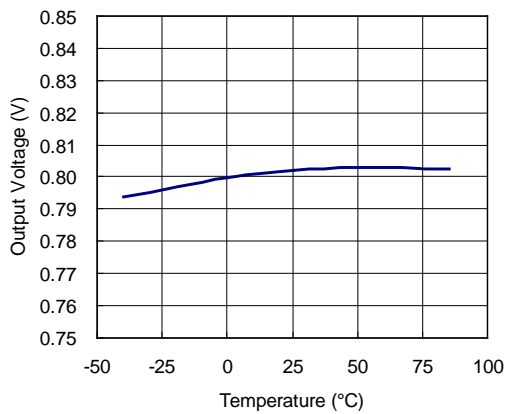

RP202x18xx

VIN=2.8V

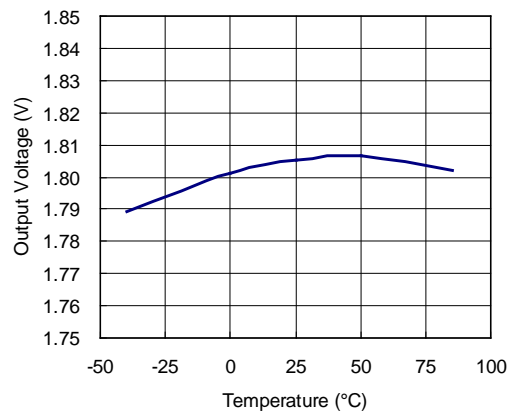

---

**RP202x**

---

NO.EA-279-170710

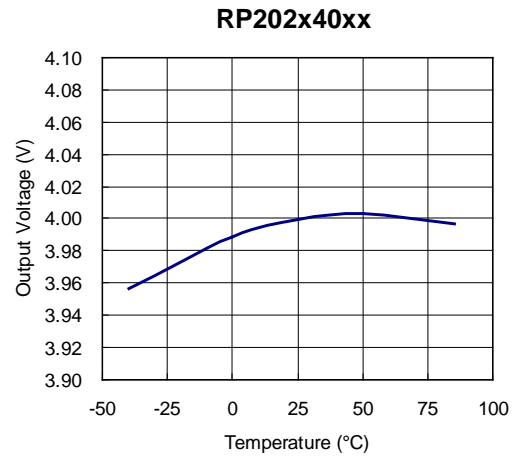
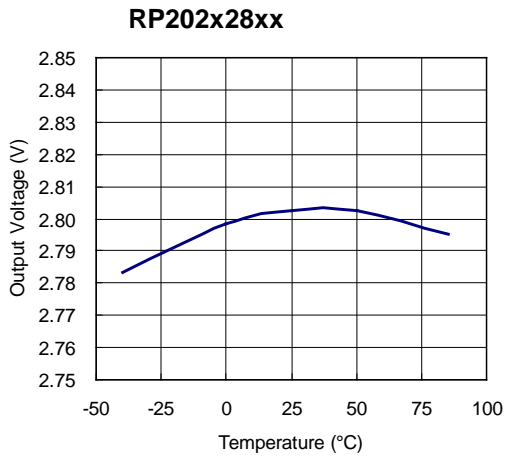
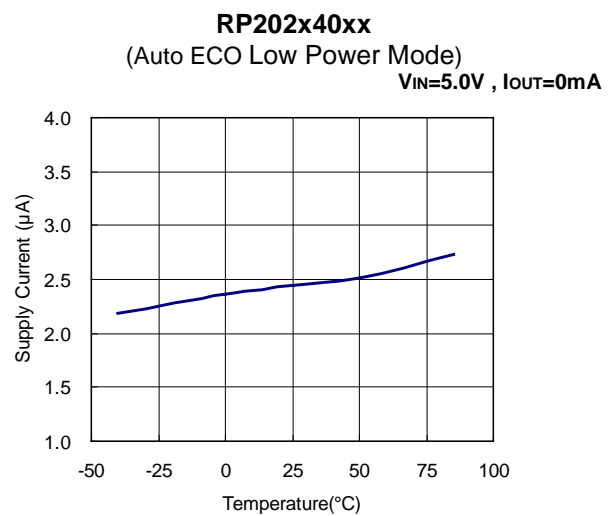
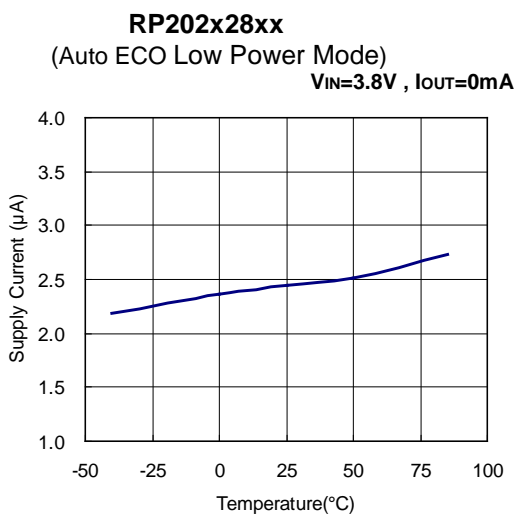
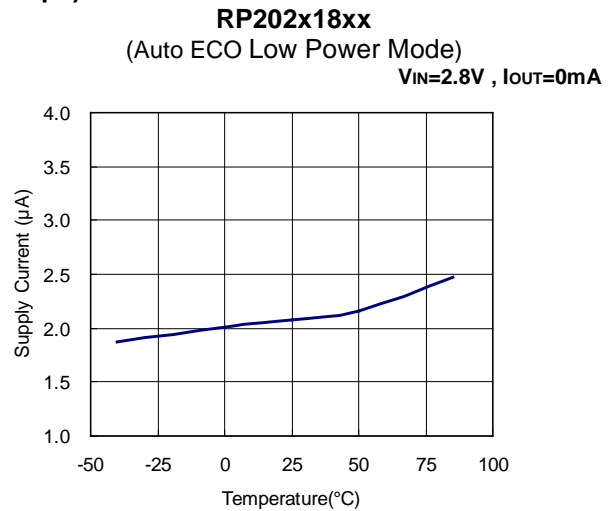
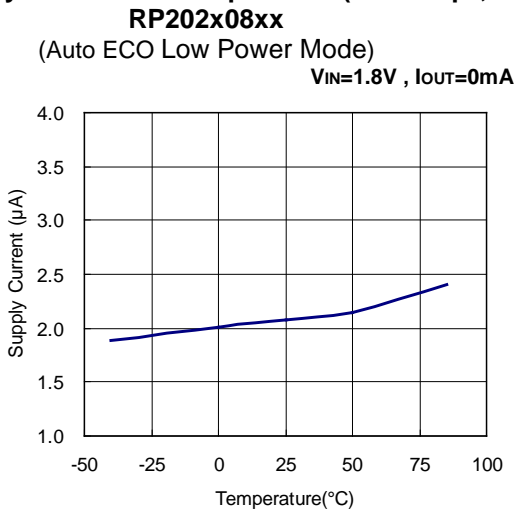
**6) Supply Current vs. Temperature (C1=0.47μF, C2=0.47μF)**

7) Dropout Voltage vs. Output Current (C1=0.47μF, C2=0.47μF)

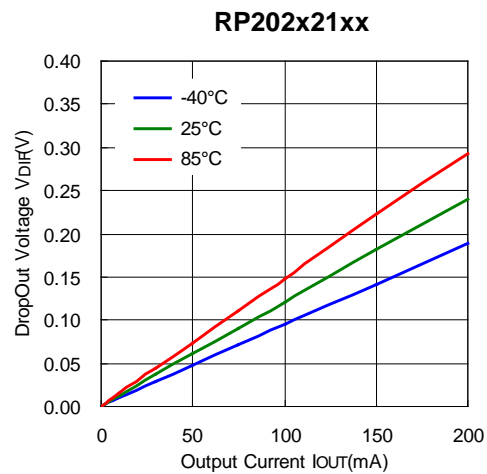
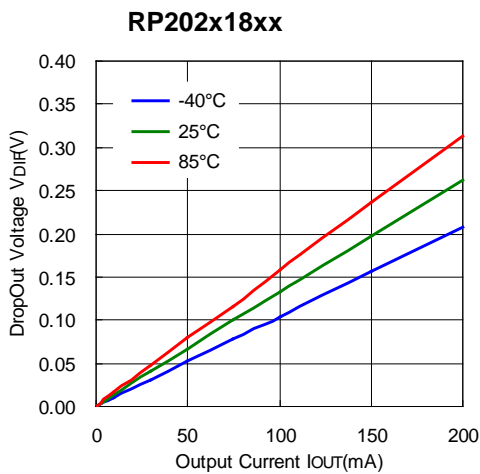
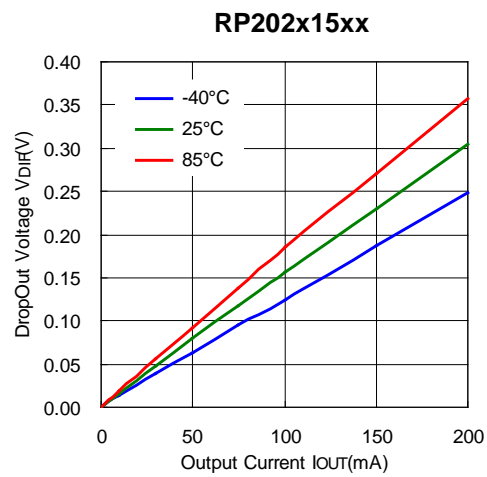
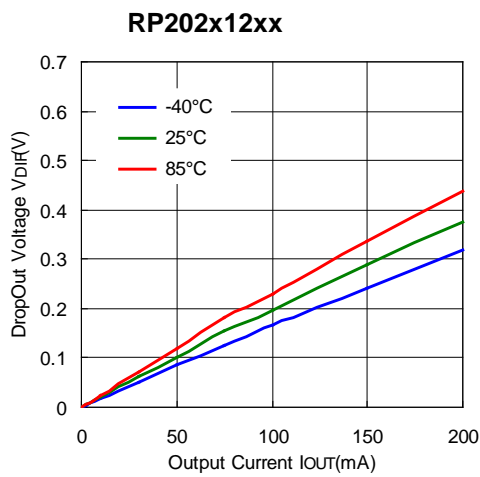
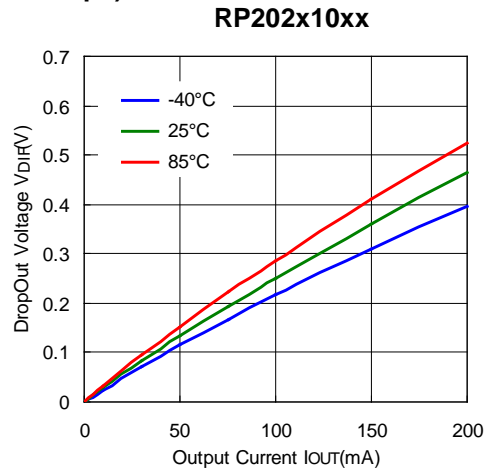
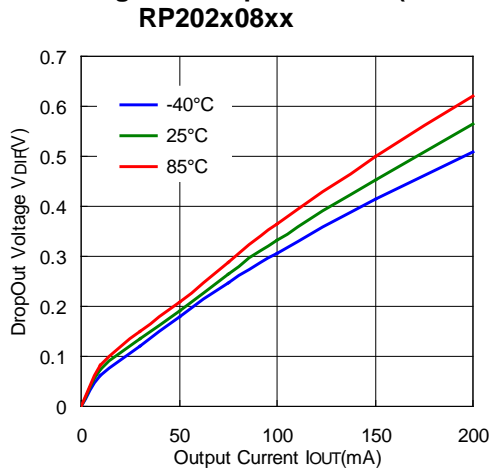

# RP202x

NO.EA-279-170710

**RP202x28xx**

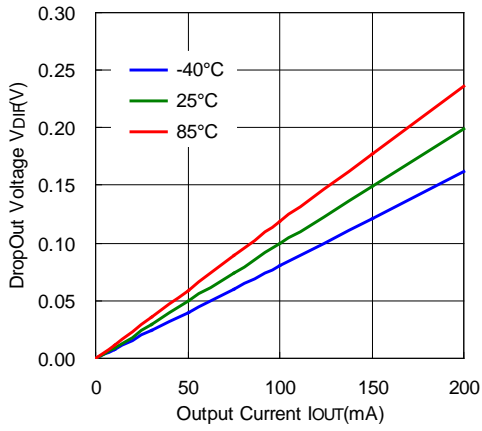

**RP202x33xx**

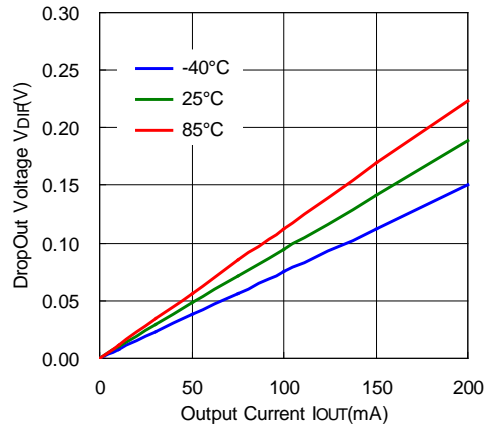

**RP202x40xx**

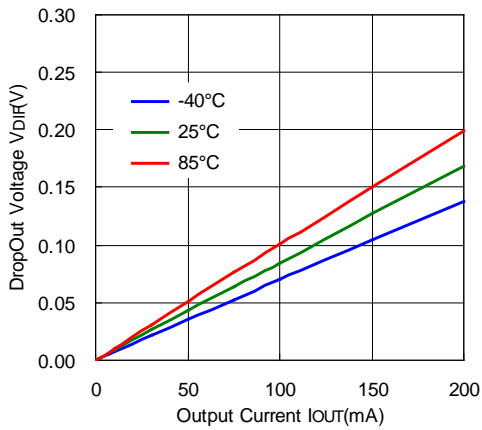

## 8) Dropout Voltage vs Set Output Voltage

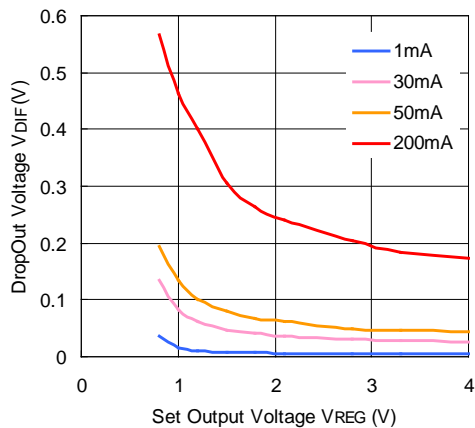

## 9) Maximum Output Current vs. Set Output Voltage (C1=0.47μF, C2=0.47μF, VIN=1.4V)

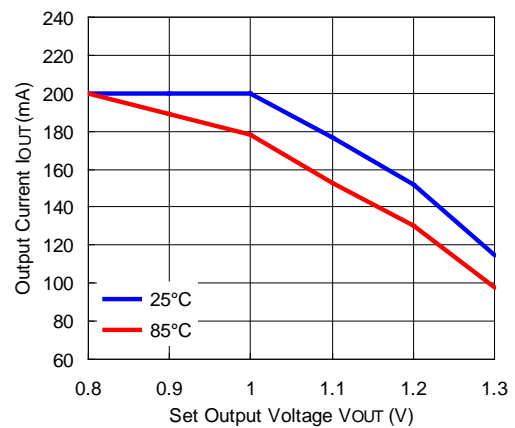

10) Ripple Rejection vs. Input Bias Voltage (C1=none, C2=0.47μF, Ripple=0.2Vp-p, Ta=25°C)

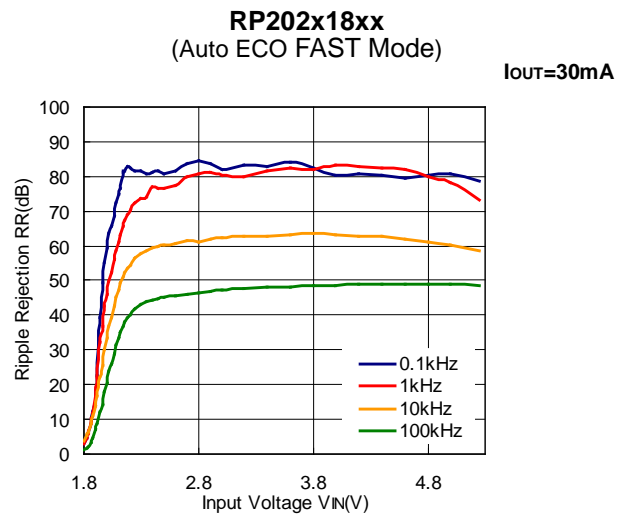
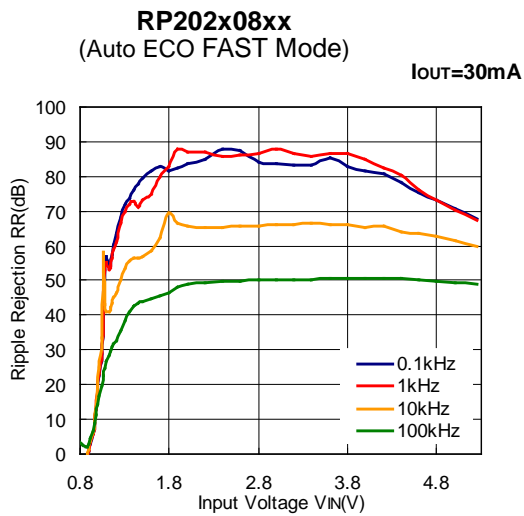
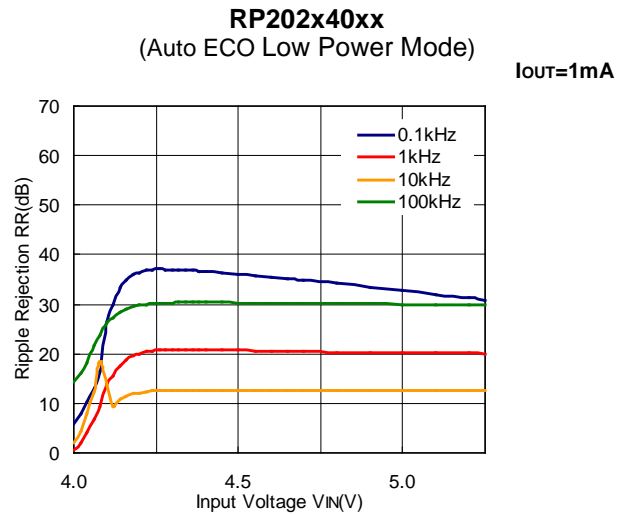
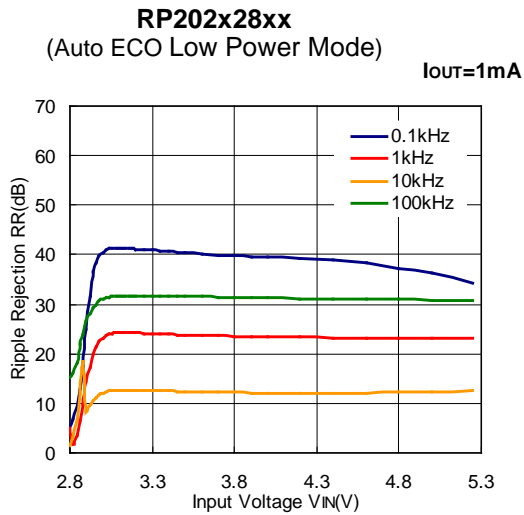
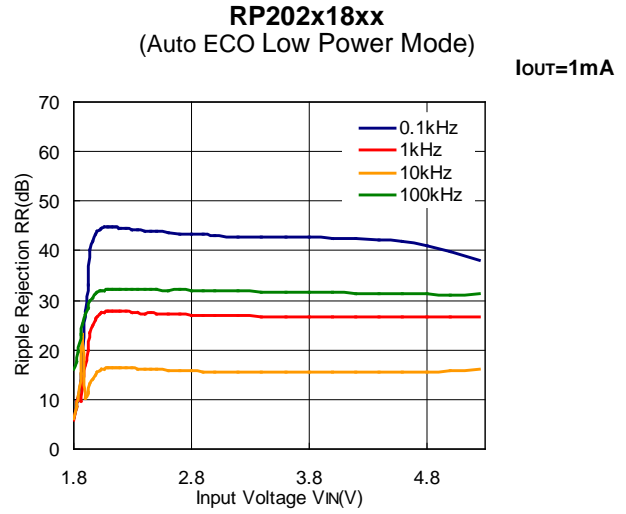
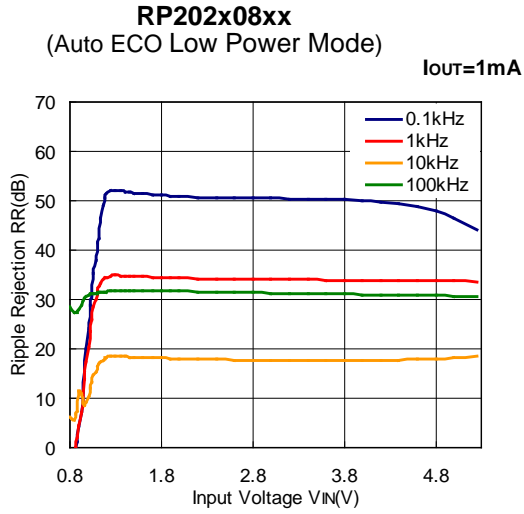

# RP202x

NO.EA-279-170710

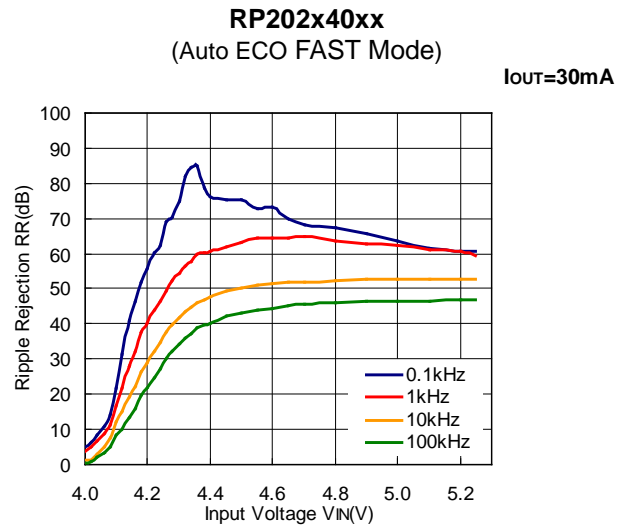
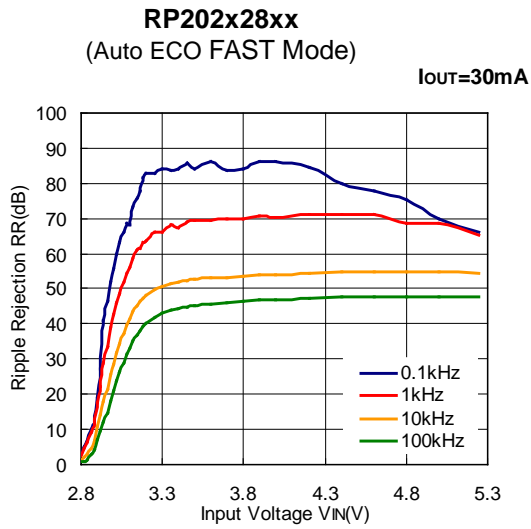

## 11) Ripple Rejection vs. Frequency ( $C1=none$ , $C2=0.47\mu F$ , $Ripple=0.2Vp-p$ , $T_a=25^\circ C$ )

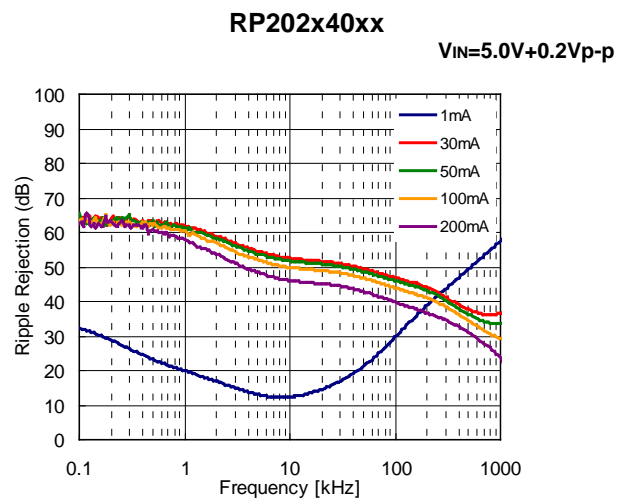
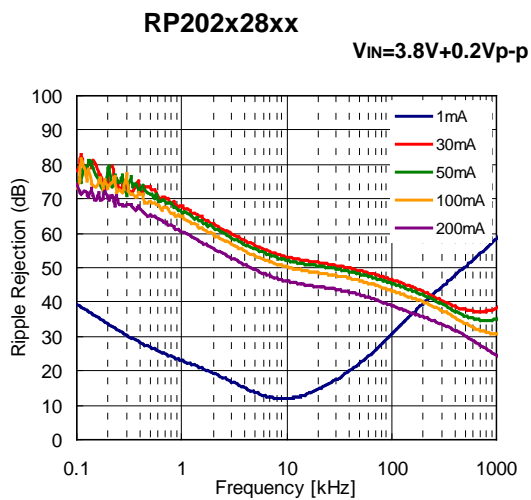
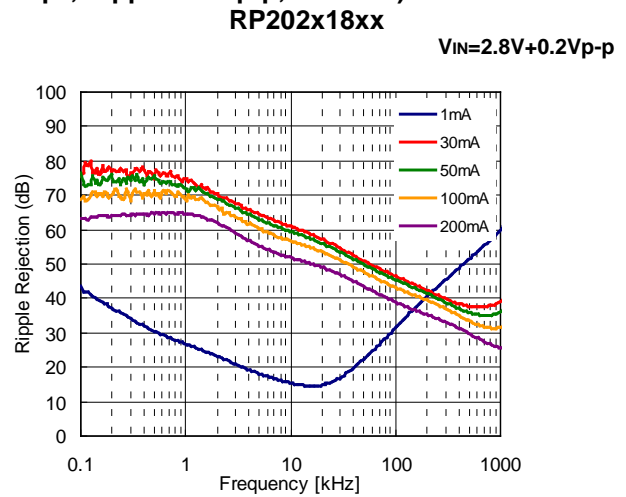
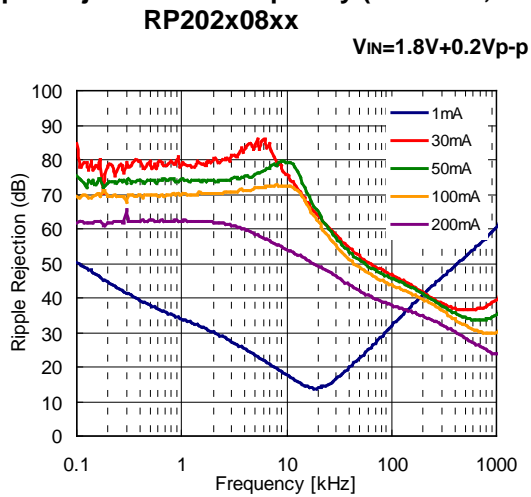



12) Input Transient Response (C1=none, C2=0.47μF, tr=tf=5μs, Ta=25°C)

**RP202x08xx**  
(Auto ECO Low Power Mode)  
VIN=1.8V↔2.8V, IOUT=1mA

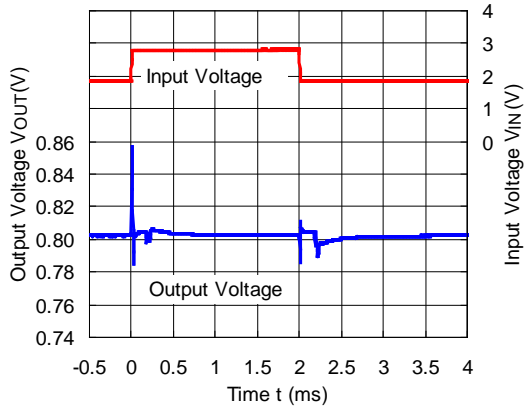

**RP202x18xx**  
(Auto ECO Low Power Mode)  
VIN=2.8V↔3.8V, IOUT=1mA

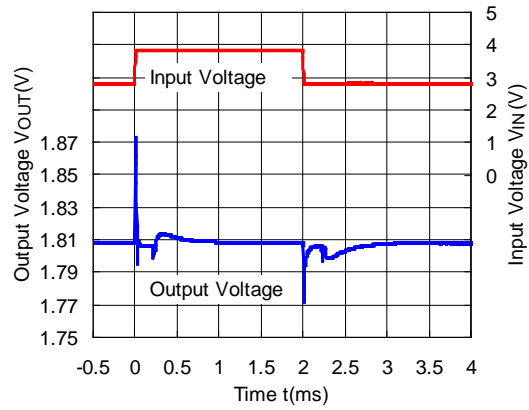

**RP202x28xx**  
(Auto ECO Low Power Mode)  
VIN=3.8V↔4.8V, IOUT=1mA

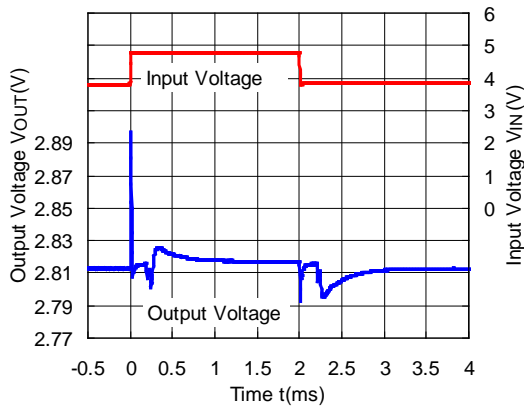

**RP202x40xx**  
(Auto ECO Low Power Mode)  
VIN=5.0V↔5.25V, IOUT=1mA

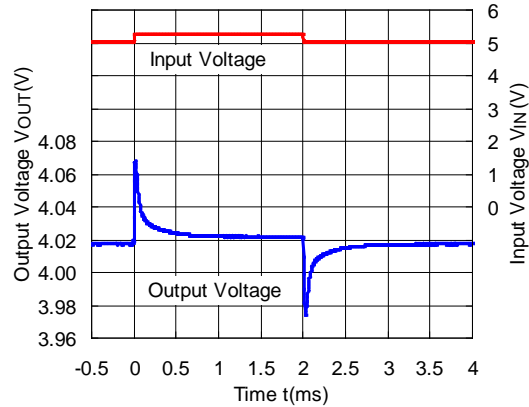

**RP202x08xx**  
(Auto ECO FAST Mode)  
VIN=1.8V↔2.8V, IOUT=30mA

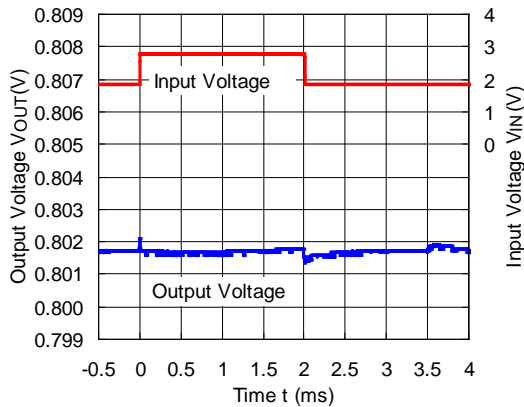

**RP202x18xx**  
(Auto ECO FAST Mode)  
VIN=2.8V↔3.8V, IOUT=30mA

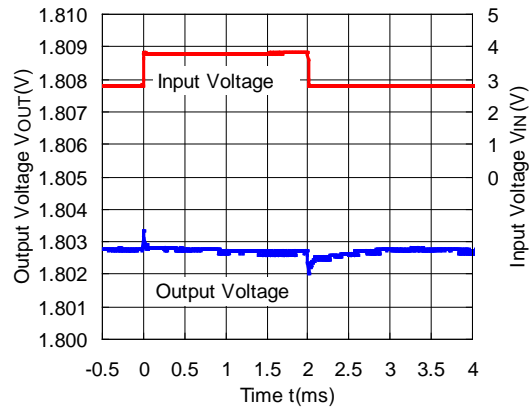

# RP202x

NO.EA-279-170710

**RP202x28xx**  
(Auto ECO FAST Mode)  
 $V_{IN}=3.8V \leftrightarrow 4.8V$ ,  $I_{OUT}=30mA$

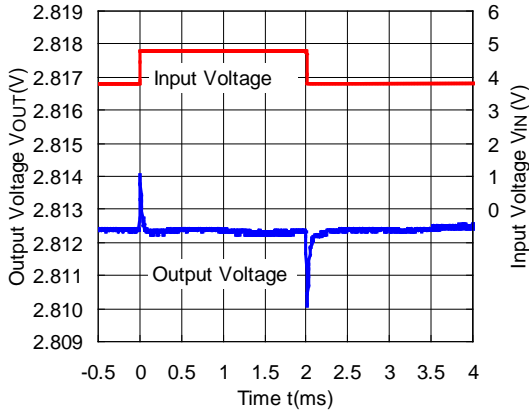

**RP202x40xx**  
(Auto ECO FAST Mode)  
 $V_{IN}=5.0V \leftrightarrow 5.25V$ ,  $I_{OUT}=30mA$

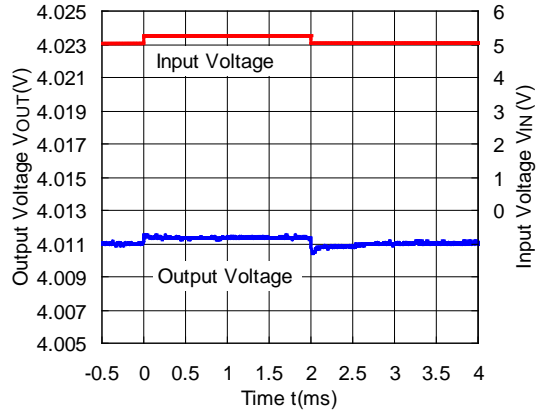

### 13) Load Transient Response ( $C1=0.47\mu F$ , $C2=0.47\mu F$ , $t_r=t_f=0.5\mu s$ , $T_a=25^\circ C$ )

**RP202x08xx**  
(Auto ECO Low Power Mode  $\leftrightarrow$  FAST Mode)  
 $V_{IN}=1.8V$

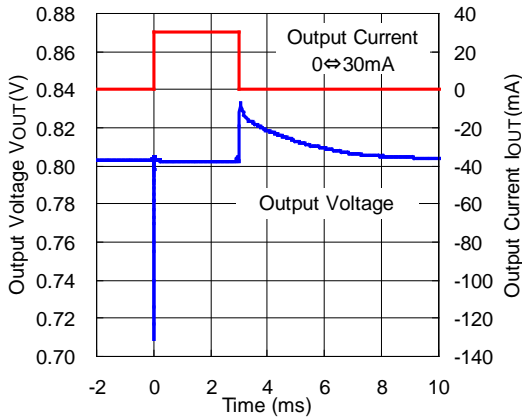

**RP202x18xx**  
(Auto ECO Low Power Mode  $\leftrightarrow$  FAST Mode)  
 $V_{IN}=2.8V$

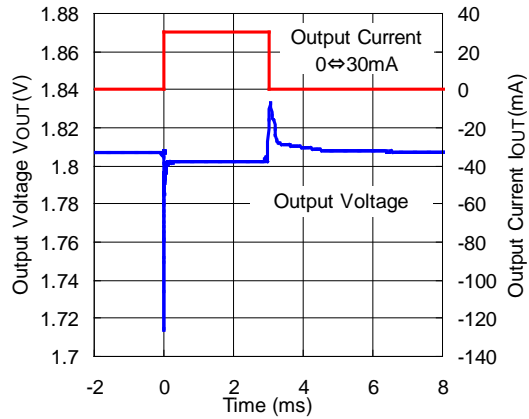

**RP202x28xx**  
(Auto ECO Low Power Mode  $\leftrightarrow$  FAST Mode)  
 $V_{IN}=3.8V$

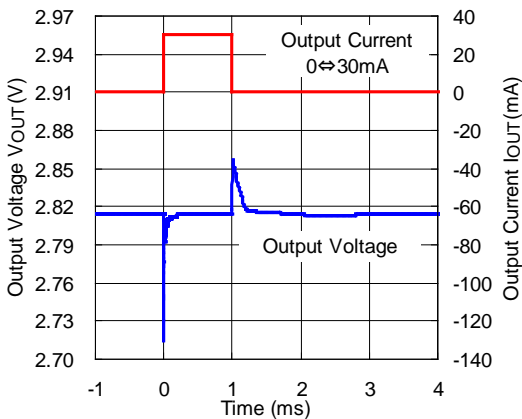

**RP202x40xx**  
(Auto ECO Low Power Mode  $\leftrightarrow$  FAST Mode)  
 $V_{IN}=5.0V$

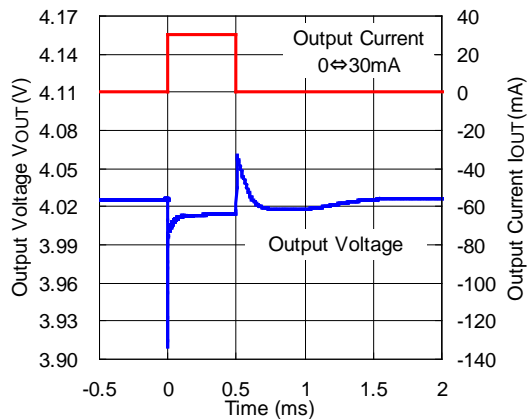

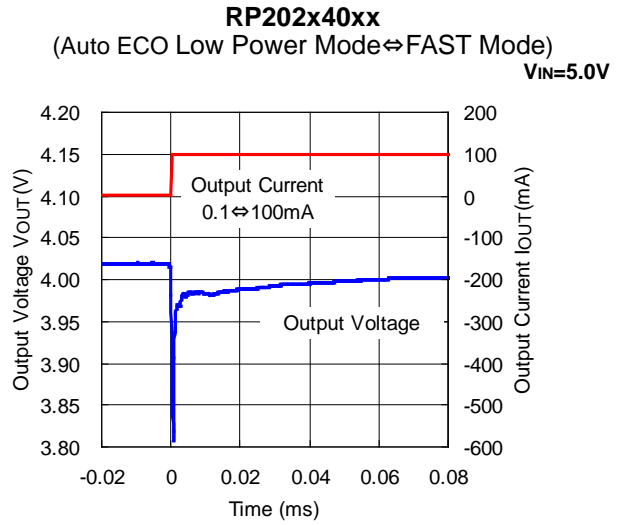
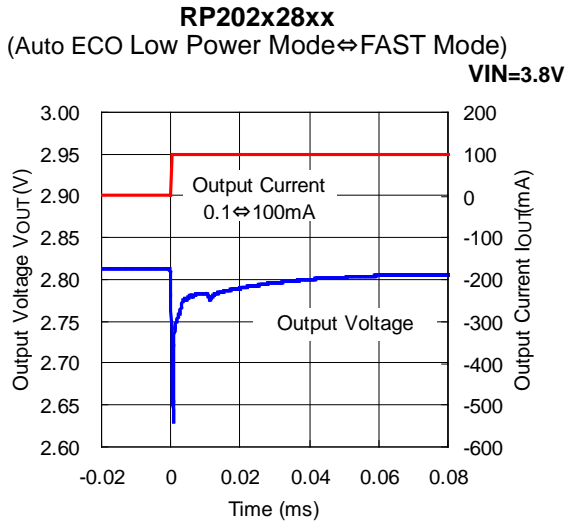

14) Turn On Waveform (Output Voltage) with CE pin (C1=0.47μF, T<sub>a</sub>=25°C)

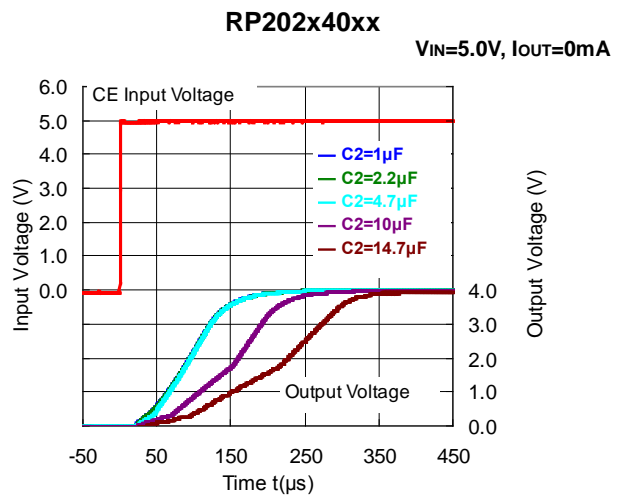
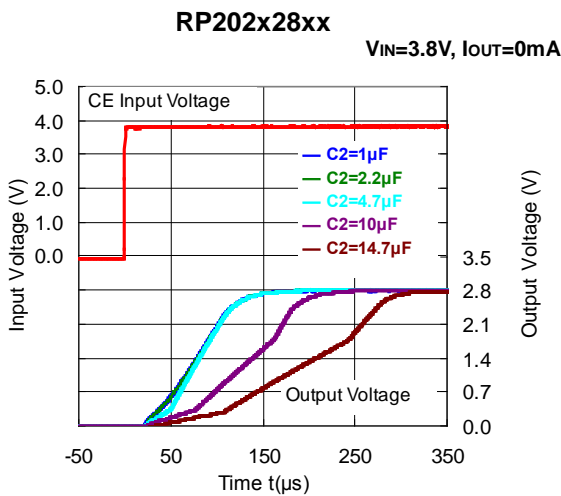
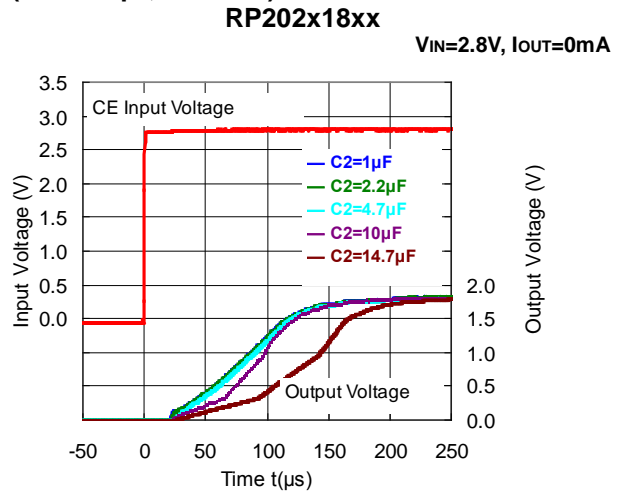
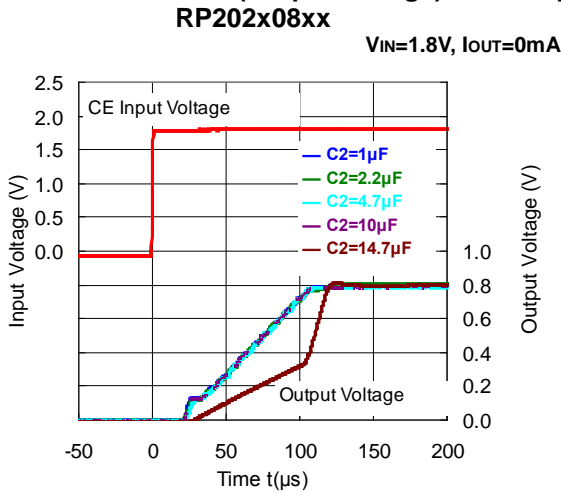

**RP202x**

NO.EA-279-170710

**15) Turn On Input Waveform (Input Current) with CE pin (C1=0.47μF, Ta=25°C)**

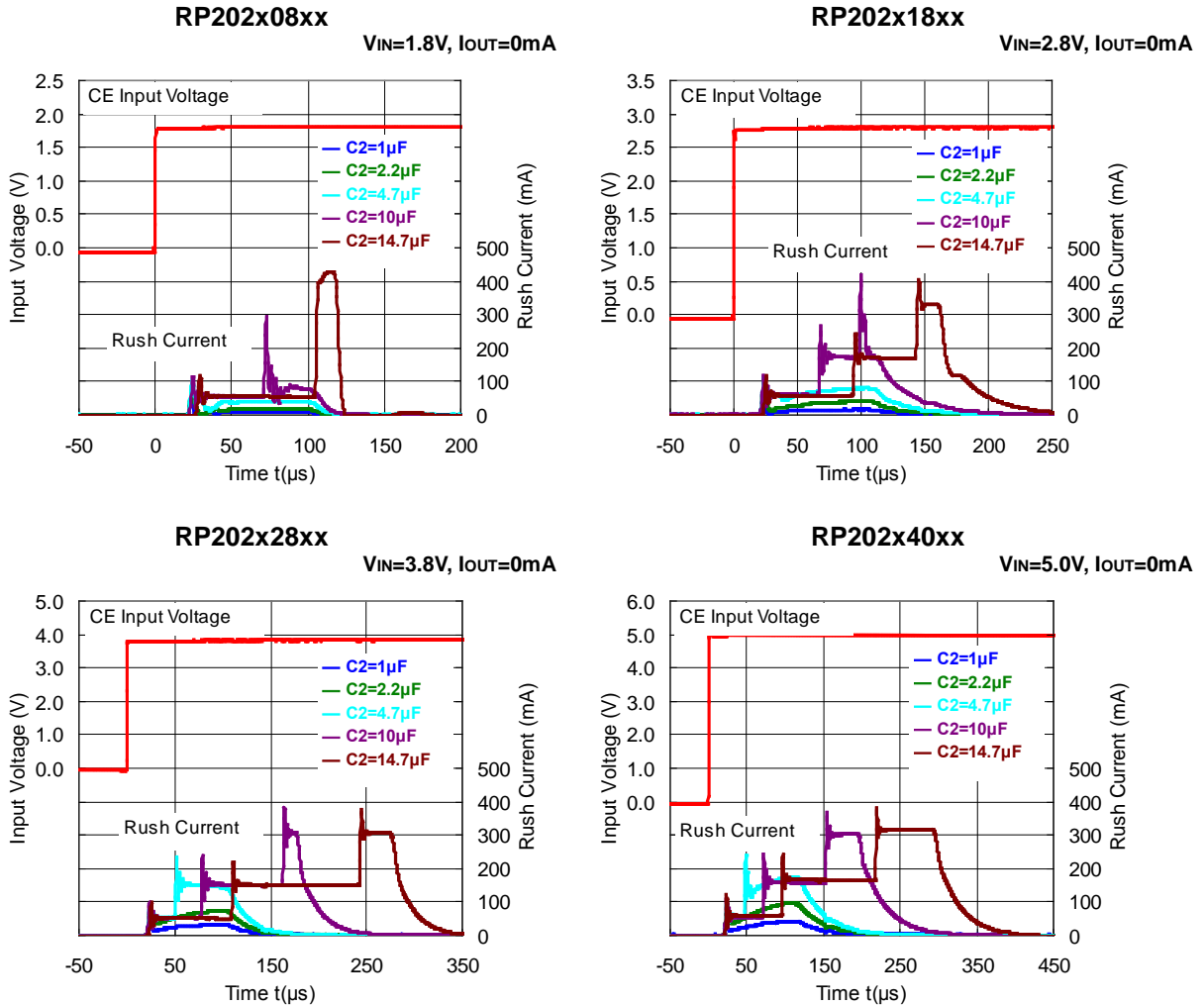

**16) Turn On Speed with CE pin (D Version) (C1=0.47μF, C2=0.47μF, Ta=25°C)**

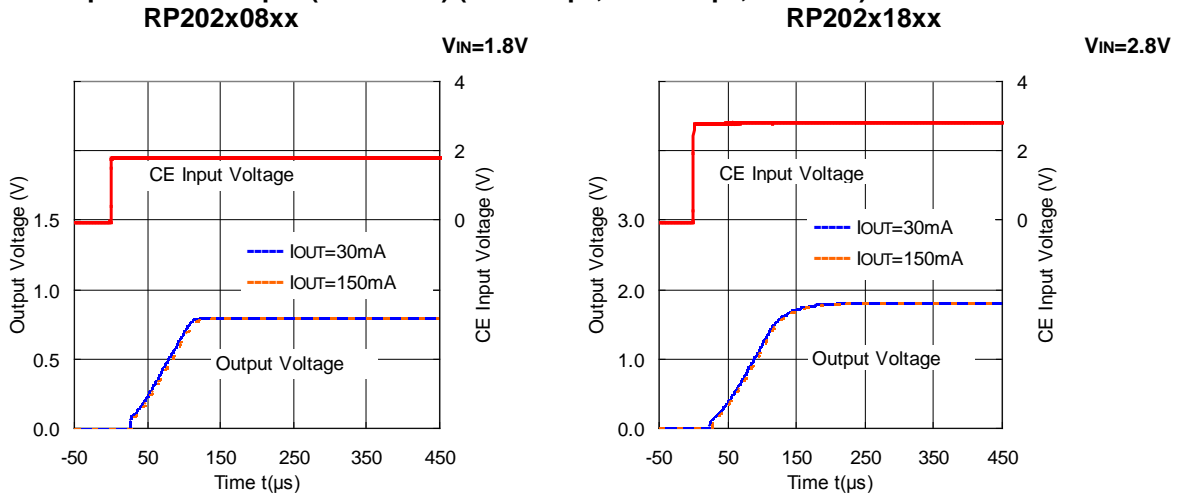

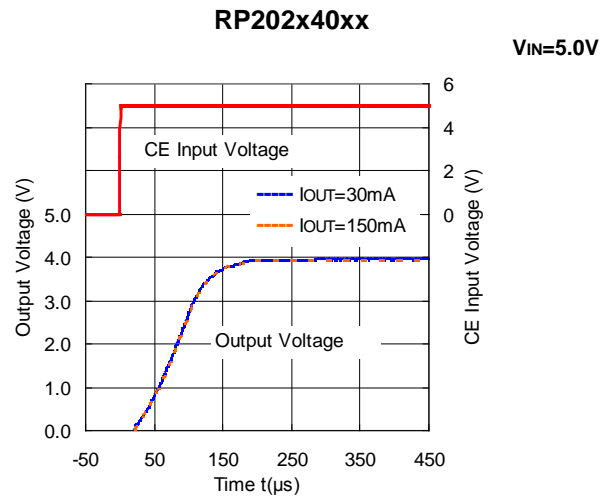
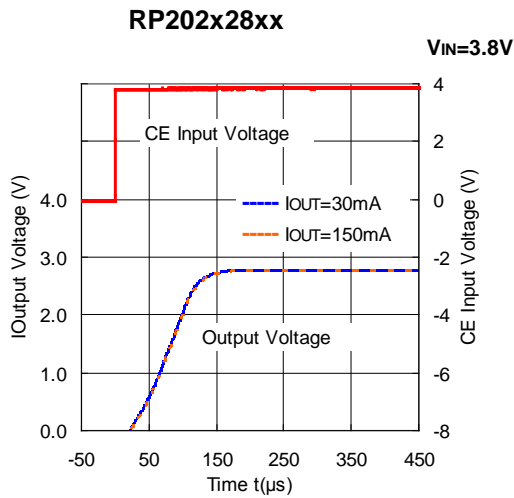

17) Turn Off Speed with CE pin (D Version) ( $C1=0.47\mu F$ ,  $C2=0.47\mu F$ ,  $T_a=25^\circ C$ )

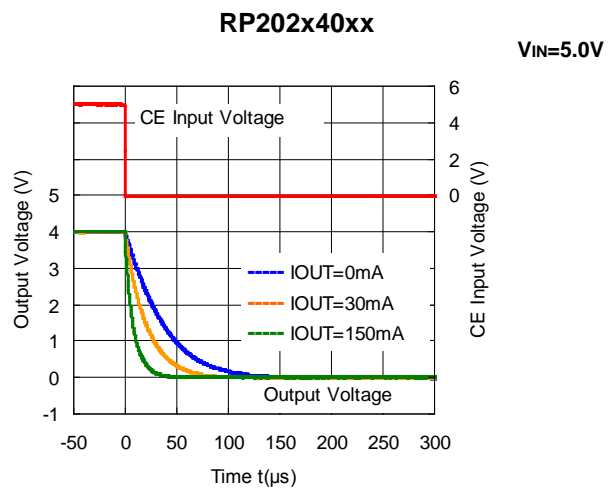
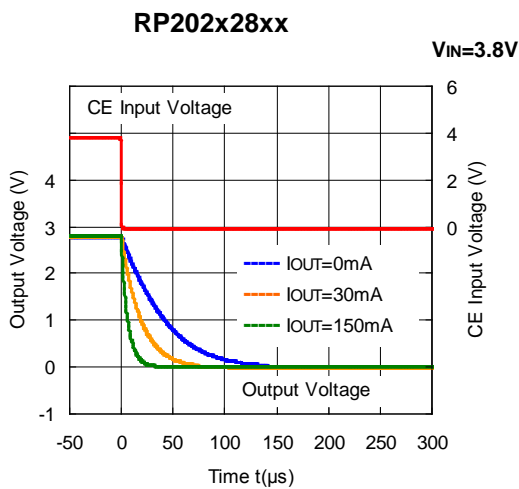
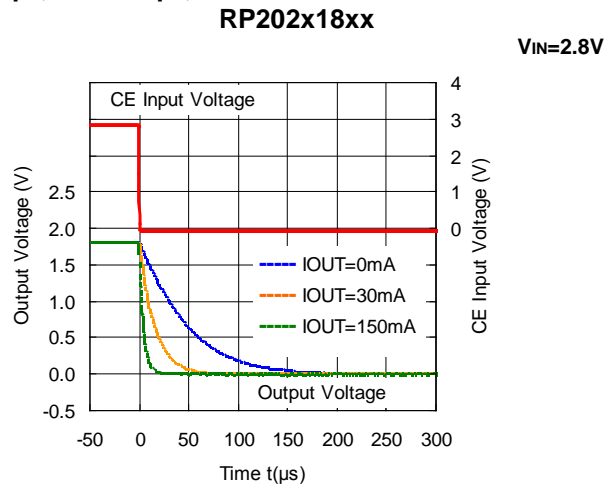
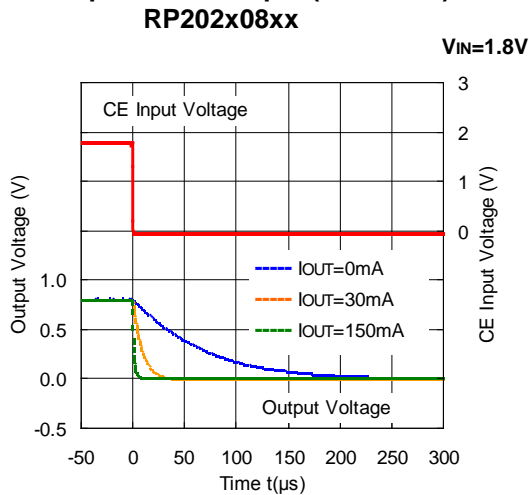

The power dissipation of the package is dependent on PCB material, layout, and environmental conditions. The following conditions are used in this measurement.

**Measurement Conditions**

	<b>Standard Test Land Pattern</b>
Environment	Mounting on Board (Wind Velocity = 0 m/s)
Board Material	Glass Cloth Epoxy Plastic (Double-Sided Board)
Board Dimensions	40 mm × 40 mm × 1.6 mm
Copper Ratio	Top Side: Approx. 50% Bottom Side: Approx. 50%
Through-holes	φ 0.54 mm × 24 pcs

**Measurement Result**

(Ta = 25°C, Tjmax = 125°C)

	<b>Standard Test Land Pattern</b>
Power Dissipation	400 mW
Thermal Resistance	$\theta_{ja} = (125 - 25^\circ\text{C}) / 0.4 \text{ W} = 250^\circ\text{C/W}$
	$\theta_{jc} = 67^\circ\text{C/W}$

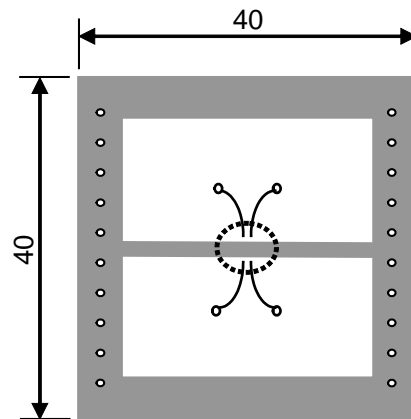
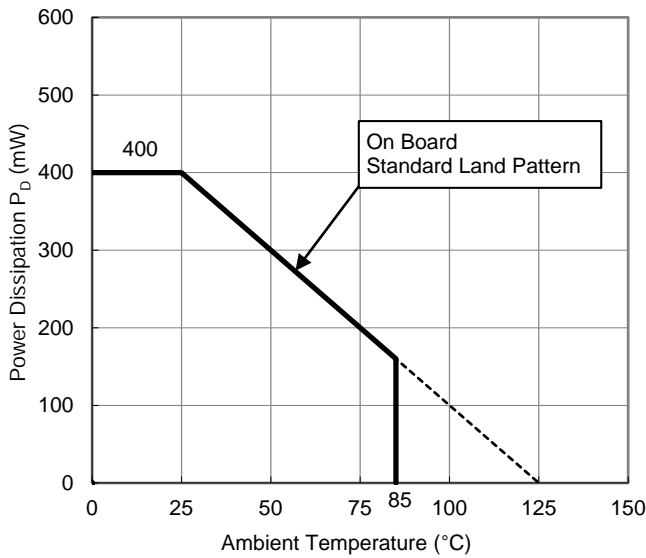

○ IC Mount Area (mm)

**Power Dissipation vs. Ambient Temperature**

**Measurement Board Pattern**

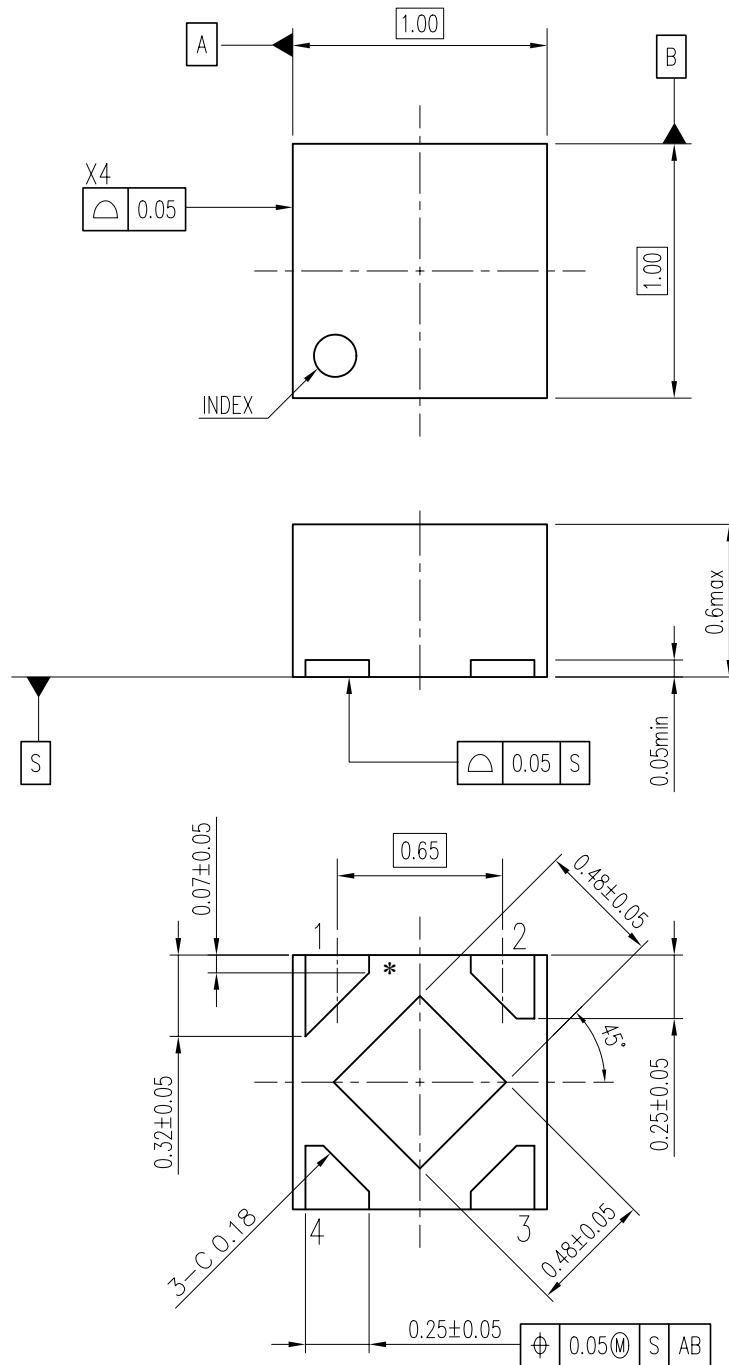

DFN(PL)1010-4 Package Dimensions (Unit: mm)

AKABAYASHI

\* The tab on the bottom of the package shown by blue circle is a substrate potential (GND). It is recommended that this tab be connected to the ground plane on the board but it is possible to leave the tab floating.

The power dissipation of the package is dependent on PCB material, layout, and environmental conditions. The following conditions are used in this measurement.

**Measurement Conditions**

	<b>Standard Test Land Pattern</b>
Environment	Mounting on Board (Wind Velocity = 0 m/s)
Board Material	Glass Cloth Epoxy Plastic (Double-Sided Board)
Board Dimensions	40 mm × 40 mm × 1.6 mm
Copper Ratio	Top Side: Approx. 50% Bottom Side: Approx. 50%
Through-holes	φ 0.5 mm × 44 pcs

**Measurement Result**

(Ta = 25°C, Tjmax = 125°C)

	<b>Standard Test Land Pattern</b>	<b>Free Air</b>
Power Dissipation	380 mW	150 mW
Thermal Resistance	$\theta_{ja} = (125 - 25^\circ\text{C}) / 0.38\text{W} = 263^\circ\text{C/W}$ $\theta_{ja} = 75^\circ\text{C/W}$	$\theta_{ja} = (125 - 25^\circ\text{C}) / 0.15\text{W} = 667^\circ\text{C/W}$ -

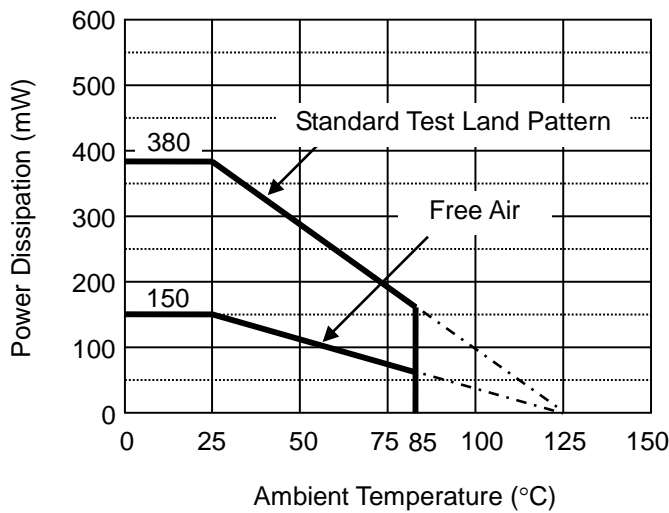

**Power Dissipation vs. Ambient Temperature**

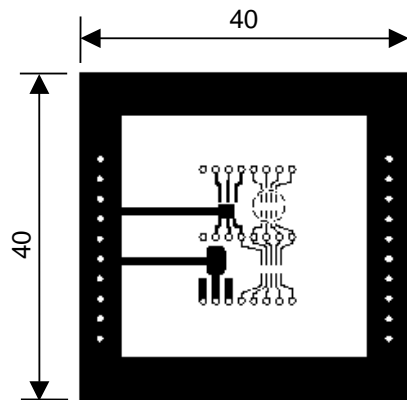

○ IC Mount Area (mm)

**Measurement Board Pattern**



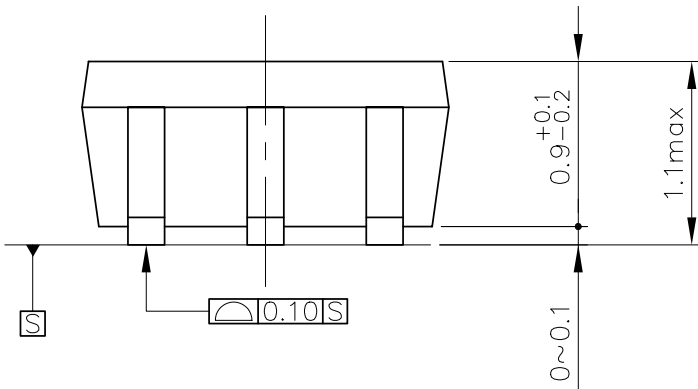

UNIT: mm

SC-88A Package Dimensions

The power dissipation of the package is dependent on PCB material, layout, and environmental conditions. The following conditions are used in this measurement.

**Measurement Conditions**

	<b>Standard Test Land Pattern</b>
Environment	Mounting on Board (Wind Velocity = 0 m/s)
Board Material	Glass Cloth Epoxy Plastic (Double-Sided Board)
Board Dimensions	40 mm x 40 mm x 1.6 mm
Copper Ratio	Top Side: Approx. 50% Bottom Side: Approx. 50%
Through-holes	φ 0.5 mm x 44 pcs

**Measurement Result**

(Ta = 25°C, Tjmax = 125°C)

	<b>Standard Test Land Pattern</b>	<b>Free Air</b>
Power Dissipation	420 mW	250 mW
Thermal Resistance	$\theta_{ja} = (125 - 25^\circ\text{C}) / 0.42 \text{ W} = 238^\circ\text{C/W}$	400°C/W

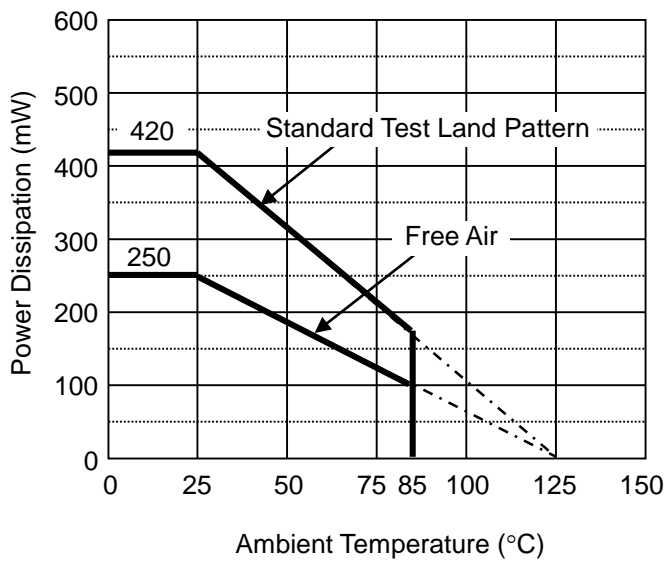

**Power Dissipation vs. Ambient Temperature**

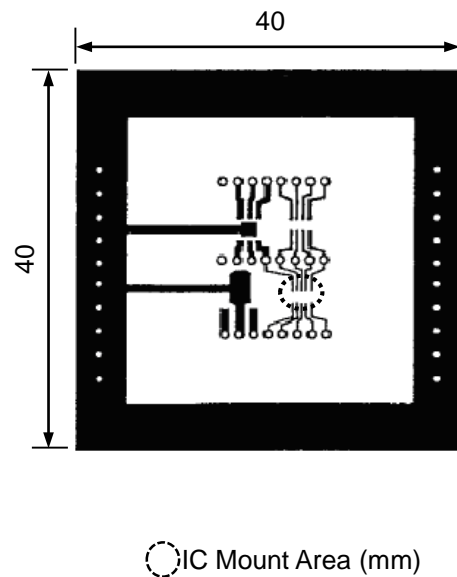

**Measurement Board Pattern**



SOT-23-5 Package Dimensions



1. The products and the product specifications described in this document are subject to change or discontinuation of production without notice for reasons such as improvement. Therefore, before deciding to use the products, please refer to our sales representatives for the latest information thereon.
2. The materials in this document may not be copied or otherwise reproduced in whole or in part without prior written consent of our company.
3. Please be sure to take any necessary formalities under relevant laws or regulations before exporting or otherwise taking out of your country the products or the technical information described herein.
4. The technical information described in this document shows typical characteristics of and example application circuits for the products. The release of such information is not to be construed as a warranty of or a grant of license under our company's or any third party's intellectual property rights or any other rights.
5. The products listed in this document are intended and designed for use as general electronic components in standard applications (office equipment, telecommunication equipment, measuring instruments, consumer electronic products, amusement equipment etc.). Those customers intending to use a product in an application requiring extreme quality and reliability, for example, in a highly specific application where the failure or misoperation of the product could result in human injury or death (aircraft, spacevehicle, nuclear reactor control system, traffic control system, automotive and transportation equipment, combustion equipment, safety devices, life support system etc.) should first contact us.
6. We are making our continuous effort to improve the quality and reliability of our products, but semiconductor products are likely to fail with certain probability. In order to prevent any injury to persons or damages to property resulting from such failure, customers should be careful enough to incorporate safety measures in their design, such as redundancy feature, fire containment feature and fail-safe feature. We do not assume any liability or responsibility for any loss or damage arising from misuse or inappropriate use of the products.
7. Anti-radiation design is not implemented in the products described in this document.
8. The X-ray exposure can influence functions and characteristics of the products. Confirm the product functions and characteristics in the evaluation stage.
9. WLCSP products should be used in light shielded environments. The light exposure can influence functions and characteristics of the products under operation or storage.
10. There can be variation in the marking when different AOI (Automated Optical Inspection) equipment is used. In the case of recognizing the marking characteristic with AOI, please contact our sales or our distributor before attempting to use AOI.
11. Please contact our sales representatives should you have any questions or comments concerning the products or the technical information.



**Nisshinbo Micro Devices Inc.**

**Official website**

<https://www.nisshinbo-microdevices.co.jp/en/>

**Purchase information**

<https://www.nisshinbo-microdevices.co.jp/en/buy/>

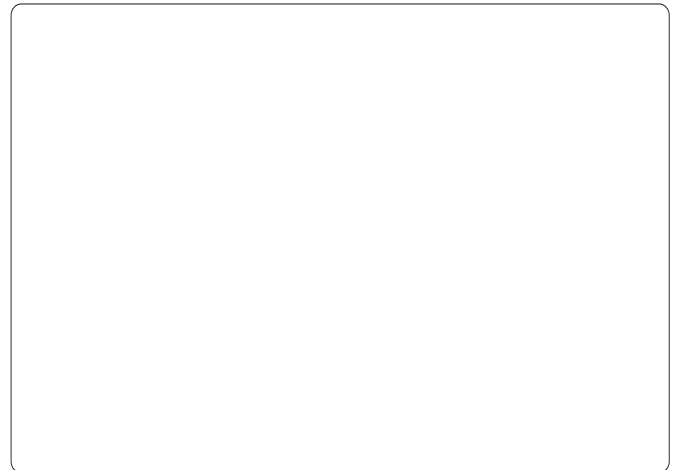

## X-ON Electronics

Largest Supplier of Electrical and Electronic Components

*Click to view similar products for [LDO Voltage Regulators](#) category:*

*Click to view products by [Nisshinbo](#) manufacturer:*

Other Similar products are found below :

[AP7363-SP-13](#) [NCV8664CST33T3G](#) [L79M05TL-E](#) [AP7362-HA-7](#) [PT7M8202B12TA5EX](#) [TCR3DF185,LM\(CT](#) [TLF4949EJ](#)  
[NCP4687DH15T1G](#) [NCV8703MX30TCG](#) [LP2951CN](#) [NCV4269CPD50R2G](#) [AP7315-25W5-7](#) [NCV47411PAAJR2G](#) [AP2111H-1.2TRG1](#)  
[ZLDO1117QK50TC](#) [AZ1117ID-ADJTRG1](#) [NCV4263-2CPD50R2G](#) [NCP706ABMX300TAG](#) [NCP114BMX075TCG](#) [MC33269T-3.5G](#)  
[TLE4471GXT](#) [AP7315-33SA-7](#) [NCV4266-2CST33T3G](#) [NCP715SQ15T2G](#) [NCV8623MN-50R2G](#) [NCV563SQ18T1G](#) [NCV8664CDT33RKG](#)  
[NCV4299CD250R2G](#) [NCP715MX30TBG](#) [NCV8702MX25TCG](#) [TLE7270-2E](#) [NCV562SQ25T1G](#) [AP2213D-3.3TRG1](#) [AP2202K-2.6TRE1](#)  
[NCV8170BMX300TCG](#) [NCV8152MX300180TCG](#) [NCP700CMT45TBG](#) [AP7315-33W5-7](#) [NCP154MX180300TAG](#) [AP2113AMTR-G1](#)  
[NJW4104U2-33A-TE1](#) [MP2013AGG-5-P](#) [NCV8775CDT50RKG](#) [NJM2878F3-45-TE1](#) [S-19214B00A-V5T2U7](#) [S-19214B50A-V5T2U7](#) [S-](#)  
[19213B50A-V5T2U7](#) [S-19214BC0A-E8T1U7\\*1](#) [S-19213B00A-V5T2U7](#) [S-19213B33A-V5T2U7](#)