

600 mA 6 MHz Synchronous Step-down DC/DC Converter

NO. EA-318-171106

OUTLINE

The RP508K is a low supply current PWM/VFM step-down DC/DC converter with synchronous rectifier featuring 600 mA⁽¹⁾ output current. Internally, a single converter consists of an oscillator, a reference voltage unit, an error amplifier, a switching control circuit, a mode control circuit, a soft-start circuit, an under-voltage lockout (UVLO) circuit, an over current protection circuit, a thermal shutdown circuit and switching transistors. By the adoption of the synchronous rectification circuit with built-in switching transistors, the RP508K works as efficient step-down DC/DC converter, without connecting external diodes. Using synchronous rectification not only increases circuit performance but also allows a design to reduce parts count.

Power controlling method can be selected from forced PWM control type or PWM/VFM auto switching control type by inputting a signal to the MODE pin. In low output current, forced PWM control switches at fixed frequency rate in order to reduce noise. Likewise, in low output current, PWM/VFM auto switching control automatically switches from PWM mode to VFM mode in order to achieve high efficiency.

Output voltage is internally fixed type which allows output voltages that range from 0.8 V to 3.3 V in 0.1 V step. The output voltage accuracy is as high as $\pm 1.5\%$ or ± 18 mV.

Protection circuits included in the RP508K are over current protection circuit and thermal shutdown circuit. Over current protection circuit supervises the inductor peak current in each switching cycle, and if the current exceeds the I_{LXLIM} , it turns off P-channel Tr. Thermal shutdown circuit detects overheating of the converter if the output pin is shorted to the ground pin (GND) etc. and stops the converter operation to protect it from damage if the junction temperature exceeds the specified temperature.

The RP508K is offered in a small and thin 6-pin DFN(PLP)1212-6F package which achieves the smallest possible footprint solution on boards where area is limited.

For an input capacitor (C_{IN}) and an output capacitor (C_{OUT}), the smaller sized 0402/1005 (inch/mm) capacitor can be used. For an inductor (L), the smaller sized 0603/1608 or 1005/2012 (inch/mm) inductor can be used.

FEATURES

- Input Voltage Range (V_{IN}) 2.3 V to 5.5 V (Absolute Maximum Ratings: 6.5 V)
- Output Voltage Range (V_{OUT}) 0.8 V to 3.3 V (Adjustable in 0.1 V steps)
- Supply Current (I_{DD2}) Typ. 15 μ A (VFM Mode with No-load)
- Standby Current ($I_{standby}$) Typ. 0 μ A
- Output Voltage Temperature Coefficient ($\Delta V_{OUT}/T_a$) Typ. ± 100 ppm/ $^{\circ}$ C
- Oscillator Frequency (f_{osc}) Typ. 6.0 MHz
- Maximum Duty Cycle (Maxduty) 100%
- Built-in Driver ON Resistance (R_{ONP} , R_{ONN}) Typ. Pch. 0.33 Ω , Nch. 0.24 Ω ($V_{IN} = 3.6$ V)
- UVLO Detector Threshold (V_{UVLO01}) Typ. 2.0 V
- Soft-start Time (t_{start}) Typ. 90 μ s

⁽¹⁾ This is an approximate value. The output current is dependent on conditions and external components.

RP508K

NO. EA-318-171106

- L_x Current Limit Circuit (I_{LXLIM})..... Typ. 1.1 A
- Output Voltage Accuracy ±1.5% (V_{OUT} ≥ 1.2 V) or ±18 mV (V_{OUT} < 1.2 V)
- Package DFN(PLP)1212-6F

APPLICATIONS

- Cellular Phones
- Smartphones
- Digital Still Camera
- Notebook PCs, PDA's
- Li-ion Battery-used Equipment

SELECTION GUIDE

The set output voltage and the auto discharge⁽¹⁾ function are user-selectable options.

Selection Guide

Product Name	Package	Quantity per Reel	Pb Free	Halogen Free
RP508Kxx1\$-TR	DFN(PLP)1212-6F	5,000 pcs	Yes	Yes

xx: Specify the set output voltage (V_{SET}) within the range of 0.8 V (08) to 3.3 V (33) in 0.1 V steps⁽²⁾.

If the set output voltage includes the 3rd digit, indicate the digit of 0.01.

(1.05 V, 1.25 V, 1.35 V)

Ex. If the set output voltage is 1.05 V: RP508K101\$5

If the set output voltage is 1.25 V: RP508K121\$5

If the set output voltage is 1.35 V: RP508K131\$5

\$: Specify the auto-discharge option.

A: Fixed output voltage type

B: Fixed output voltage type, auto-discharge function in shutdown mode

⁽¹⁾ Auto-discharge function quickly lowers the output voltage to 0 V, when the chip enable signal is switched from the active mode to the standby mode, by releasing the electrical charge accumulated in the external capacitor.

⁽²⁾ 0.05 V step is also available as a custom code.

BLOCK DIAGRAM

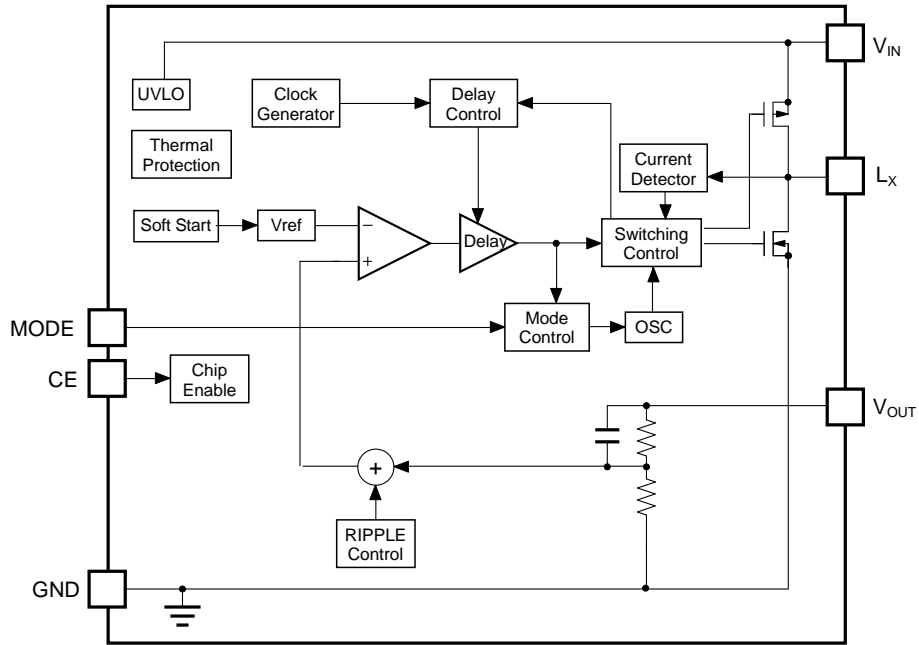

RP508Kxx1A Block Diagram

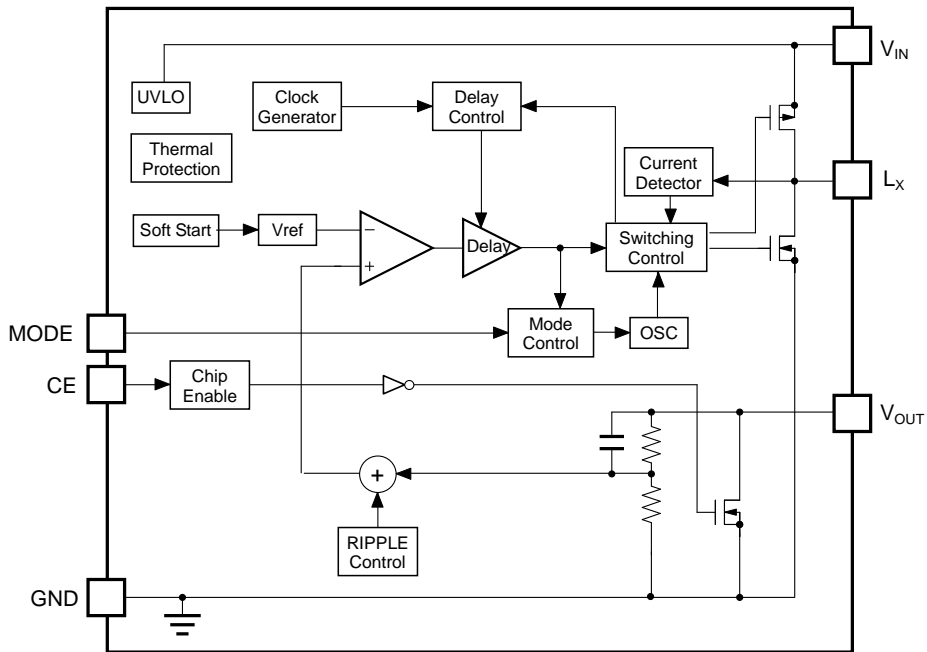

RP508Kxx1B Block Diagram

RP508K

NO. EA-318-171106

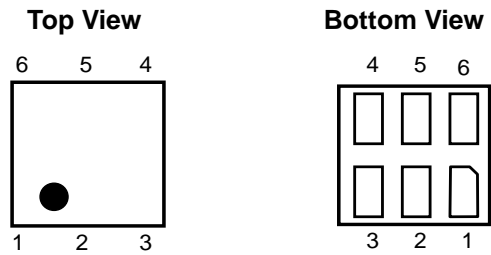
PIN DESCRIPTION**Pin Description**

Pin No.	Symbol	Pin Description
1	VOUT	Output Pin
2	MODE	Mode Control Pin ("H" forced PWM control, "L" PWM/VFM auto switching control)
3	CE	Chip Enable Pin ("H" active)
4	VIN	Input Pin
5	LX	LX Switching Pin
6	GND	Ground Pin

ABSOLUTE MAXIMUM RATINGS

Absolute Maximum Ratings

Symbol	Item	Rating	Unit
V_{IN}	V_{IN} Input Voltage	-0.3 to 6.5	V
V_{LX}	L_X Pin Voltage	-0.3 to $V_{IN} + 0.3$	V
V_{CE}	CE Pin Input Voltage	-0.3 to 6.5	V
V_{MODE}	MODE Pin Input Voltage	-0.3 to 6.5	V
V_{OUT}	V_{OUT} Pin Voltage	-0.3 to 6.5	V
I_{LX}	L_X Pin Output Current	1300	mA
P_D	Power Dissipation ⁽¹⁾ (JEDEC STD 51-7 Test Land Pattern)	666	mW
T_j	Junction Temperature Range	-40 to 125	°C
T_{stg}	Storage Temperature Range	-55 to 125	°C

ABSOLUTE MAXIMUM RATINGS

Electronic and mechanical stress momentarily exceeded absolute maximum ratings may cause the permanent damages and may degrade the life time and safety for both device and system using the device in the field. The functional operation at or over these absolute maximum ratings are not assured.

RECOMMENDED OPERATING CONDITIONS

Symbol	Item	Rating	Unit
V_{IN}	Input Voltage	2.3 to 5.5	V
T_a	Operating Temperature Range	-40 to 85	°C

RECOMMENDED OPERATING CONDITIONS

All of electronic equipment should be designed that the mounted semiconductor devices operate within the recommended operating conditions. The semiconductor devices cannot operate normally over the recommended operating conditions, even if when they are used over such conditions by momentary electronic noise or surge. And the semiconductor devices may receive serious damage when they continue to operate over the recommended operating conditions.

⁽¹⁾ Refer to *POWER DISSIPATION* for detailed information.

RP508K

NO. EA-318-171106

ELECTRICAL CHARACTERISTICS

RP508K Electrical Characteristics

(Ta = 25°C)

Symbol	Item	Conditions	Min.	Typ.	Max.	Unit	
V _{OUT}	Output Voltage	V _{IN} = V _{CE} = 3.6 V	V _{SET} ≥ 1.2 V	x0.985	x1.015	V	
			V _{SET} < 1.2 V	-0.018	+0.018	V	
fosc	Oscillator Frequency	V _{IN} = V _{CE} = 3.6 V (V _{SET} ≤ 2.6 V), V _{IN} = V _{CE} = V _{SET} + 1 V (V _{SET} > 2.6 V)	5.4	6.0	6.6	MHz	
I _{DD1}	Supply Current 1	V _{IN} = V _{CE} = 5.5 V, V _{OUT} = V _{SET} × 0.8		1000	1300	μA	
I _{DD2}	Supply Current 2	V _{IN} = V _{CE} = V _{OUT} = 5.5 V	V _{MODE} = 0 V		15	25	μA
			V _{MODE} = 5.5 V		1000	1300	μA
I _{standby}	Standby Current	V _{IN} = 5.5 V, V _{CE} = 0 V		0	5	μA	
I _{CEH}	CE "H" Input Current	V _{IN} = V _{CE} = 5.5 V	-1	0	1	μA	
I _{CEL}	CE "L" Input Current	V _{IN} = 5.5 V, V _{CE} = 0 V	-1	0	1	μA	
I _{MODEH}	Mode "H" Input Current	V _{IN} = V _{MODE} = 5.5 V, V _{CE} = 0 V	-1	0	1	μA	
I _{MODEL}	Mode "L" Input Current	V _{IN} = 5.5 V, V _{CE} = V _{MODE} = 0 V	-1	0	1	μA	
I _{VOUTH}	V _{OUT} "H" Input Current ⁽¹⁾	V _{IN} = V _{OUT} = 5.5 V, V _{CE} = 0 V	-1	0	1	μA	
I _{VOUTL}	V _{OUT} "L" Input Current	V _{IN} = 5.5 V, V _{CE} = V _{OUT} = 0 V	-1	0	1	μA	
R _{LOW}	On Resistance for Auto Discharge ⁽²⁾	V _{IN} = 3.6 V, V _{CE} = 0 V		30		Ω	
I _{LXLEAKH}	L _X Leakage Current "H"	V _{IN} = V _{LX} = 5.5 V, V _{CE} = 0 V	-1	0	5	μA	
I _{LXLEAKL}	L _X Leakage Current "L"	V _{IN} = 5.5 V, V _{CE} = V _{LX} = 0 V	-5	0	1	μA	
V _{CEH}	CE "H" Input Voltage	V _{IN} = 5.5 V	1.0			V	
V _{CEL}	CE "L" Input Voltage	V _{IN} = 2.3 V			0.4	V	
V _{MODEH}	Mode "H" Input Voltage	V _{IN} = V _{CE} = 5.5 V	1.0			V	
V _{MODEL}	Mode "L" Input Voltage	V _{IN} = V _{CE} = 2.3 V			0.4	V	
R _{ONP}	On Resistance of Pch Tr.	V _{IN} = 3.6 V, I _{LX} = -100 mA		0.33		Ω	
R _{ONN}	On Resistance of Nch Tr.	V _{IN} = 3.6 V, I _{LX} = -100 mA		0.24		Ω	
Maxduty	Maximum Duty Cycle		100			%	
t _{start}	Soft-start Time	Soft-start Time is between the rising edge of CE pin and V _{OUT} ≥ V _{SET} × 0.9.		90	150	μs	
I _{LXLIM}	L _X Current Limit		900	1100		mA	
V _{UVLO1}	UVLO Detector Threshold	V _{IN} = V _{CE}	1.9	2.0	2.1	V	
V _{UVLO2}	UVLO Released Voltage	V _{IN} = V _{CE}	2.0	2.1	2.2	V	
T _{TSD}	Thermal Shutdown Temperature	Junction Temperature		140		°C	
T _{TSR}	Thermal Shutdown Released Temperature	Junction Temperature		100		°C	

All test items listed under ELECTRICAL CHARACTERISTICS are done under the pulse load condition (T_j ≈ Ta = 25°C) except Output Voltage Temperature Coefficient.

⁽¹⁾ RP508Kxx1A only

⁽²⁾ RP508Kxx1B only

THEORY OF OPERATION

Fast Frequency and Fast Response

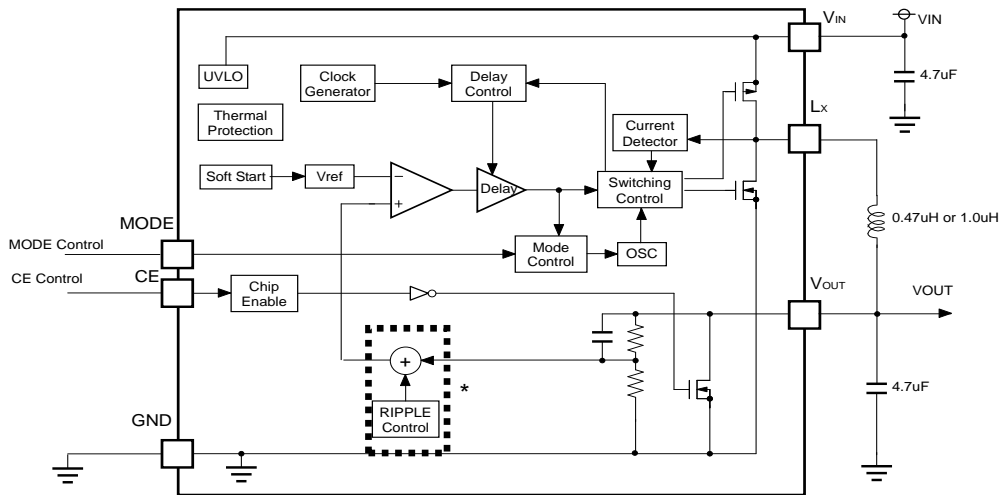

* Ripple is added and easy to detect and stabilize the system.

There are the following advantages when it operates at fast frequency (6 MHz).

- Inductance value can be reduced.
- The fluctuation of energy in one cycle is fast and small, as a result, the capacitance value of C_{OUT} can be also reduced.
- Small LC value reduced the feedback delay, then response frequency band can be wide and transient response is much improved compared with conventional line-up.

Maximum Frequency (6 MHz) Lock

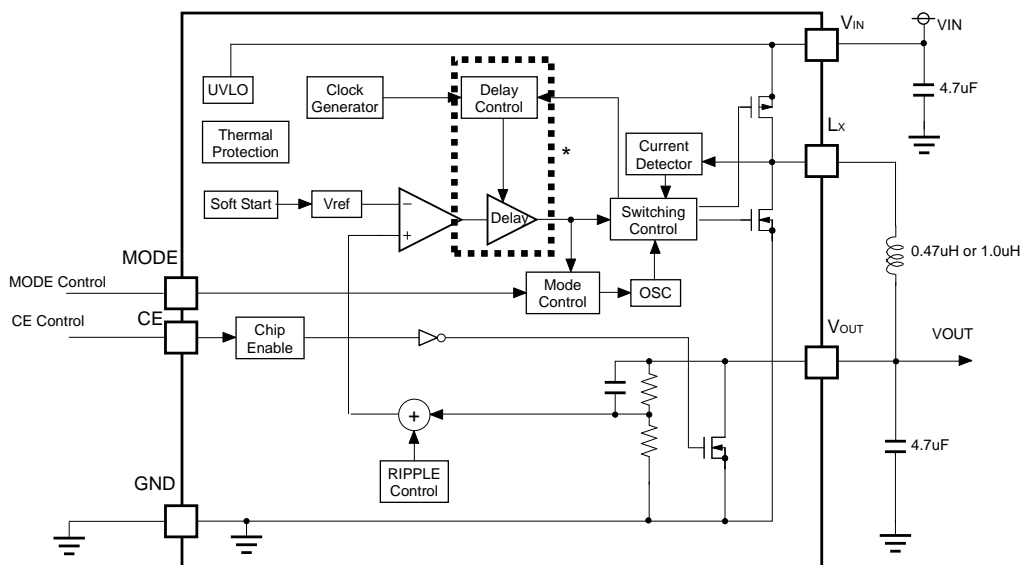

* The frequency goes faster and faster without this.

Switching frequency in order to become reference frequency (6 MHz), delay time is included the output voltage feedback loop and locked the frequency (6 MHz).

Frequency Control for Minimum On/Off Time

Minimum on/off time/Minimum off time is set. (But 100% duty is available.) In the 6 MHz, based on the calculation of input/ output relation, on/off time can be calculated, and if it is not satisfy the minimum on time / minimum off time, the reference frequency must be reduced and switching frequency is reduced.

(Ex.) Min On Time (40 ns)

① $V_{IN} = 3.6\text{ V}$ $V_{OUT} = 1.0\text{ V}$

$1/6\text{ MHz} \times 1.0\text{ V} / 3.6\text{ V} \approx 46\text{ ns} > \text{Min On Time} (= 40\text{ ns})$

→6 MHz Switching OK

② $V_{IN} = 5.5\text{ V}$ $V_{out} = 1.0\text{ V}$

$1/6\text{ MHz} \times 1.0\text{ V} / 5.5\text{ V} \approx 30\text{ ns} < \text{Min On Time} (= 40\text{ ns})$

→It must be slow down from 6 MHz

LX Waveform

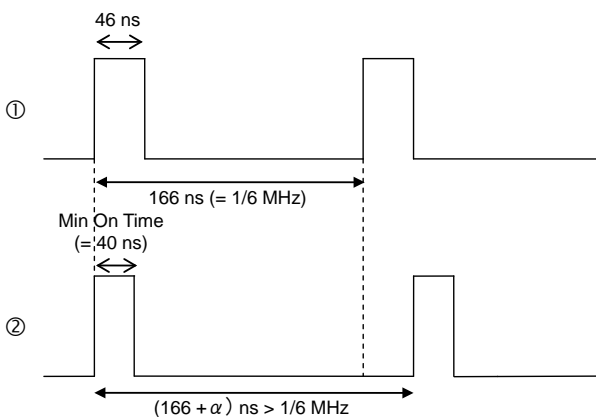

Cycle time becomes long in order to satisfy Min. on time. It is suitable with keeping the duty.

(Ex.) Min Off Time (40 ns)

① $V_{IN} = 5.0\text{ V}$ $V_{OUT} = 3.3\text{ V}$

$1/6\text{ MHz} \times (1 - 3.3\text{ V} / 5.0\text{ V}) \approx 57\text{ ns} > \text{Min Off Time} (=$

40 ns)

→6 MHz Switching OK

② $V_{IN} = 4.2\text{ V}$ $V_{OUT} = 3.3\text{ V}$

$1/6\text{ MHz} \times (1 - 3.3\text{ V} / 4.2\text{ V}) \approx 36\text{ ns} < \text{Min Off Time} (=$

40 ns)

→It must be slow down from 6 MHz

LX Waveform

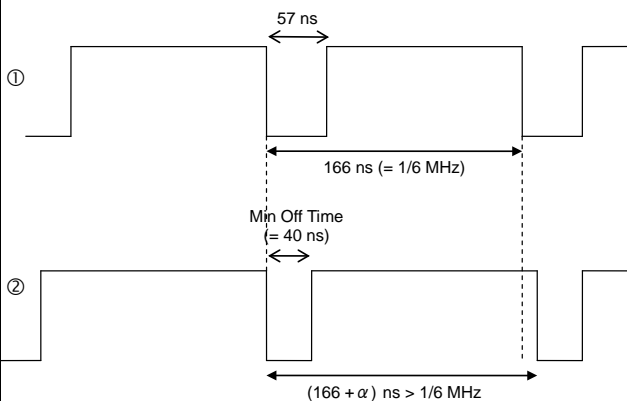

Cycle time becomes long in order to satisfy Min. off time. It is suitable with keeping the duty.

Operation of Step-Down DC/DC Converter and Output Current

The step-down DC/DC converter charges energy in the inductor when L_x Tr. turns “ON”, and discharges the energy from the inductor when L_x Tr. turns “OFF” and operates with less energy loss, so that a lower output voltage (V_{OUT}) than the input voltage (V_{IN}) can be obtained.

The operation of the step-down DC/DC converter is explained in the following figures.

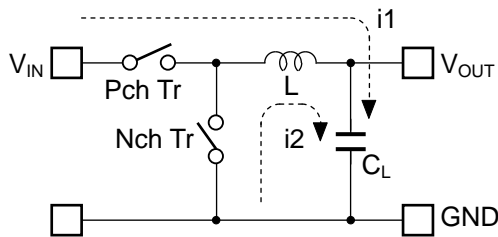

Figure 1. Basic Circuit

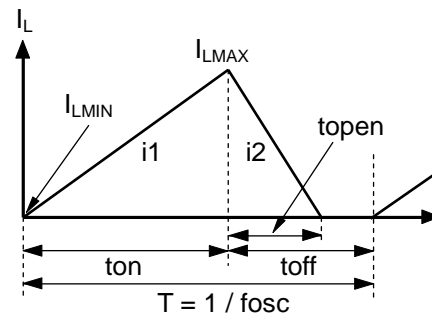

Figure 2. Inductor Current (I_L) flowing through Inductor

- Step1.** P-channel Tr. turns “ON” and the inductor current (I_L = i₁) flows, L is charged with energy. At this moment, i₁ increases from the minimum inductor current (I_{LMIN}), which is 0 A, and reaches the maximum inductor current (I_{LMAX}) in proportion to the on-time period (ton) of P-channel Tr.
- Step2.** When P-channel Tr. turns “OFF”, L tries to maintain I_L at I_{LMAX}, so L turns N-channel Tr. “ON” and the inductor current (I_L = i₂) flows into L.
- Step3.** i₂ decreases gradually and reaches I_{LMIN} after the open-time period (topen) of N-channel Tr., and then N-channel Tr. turns “OFF”. This is called discontinuous current mode.
As the output current (I_{OUT}) increases, the off-time period (toff) of P-channel Tr. runs out before I_L reaches I_{LMIN}. The next cycle starts, and P-channel Tr. turns “ON” and N-channel Tr. turns “OFF”, which means I_L starts increasing from I_{LMIN}. This is called continuous current mode.

In the case of PWM mode, V_{OUT} is maintained by controlling ton. During the PWM mode, the oscillator frequency (fosc) is constantly maintained.

As shown in Figure 2., when the step-down DC/DC operation is constant, I_{LMIN} and I_{LMAX} during ton of P-channel Tr. is same as the P-channel Tr. during toff.

The current differential between I_{LMAX} and I_{LMIN} is described as ΔI.

$$\Delta I = I_{LMAX} - I_{LMIN} = V_{OUT} \times topen / L = (V_{IN} - V_{OUT}) \times ton / L \dots \dots \dots \text{Equation 1}$$

However,

$$T = 1 / fosc = ton + toff$$

$$\text{Duty (\%)} = ton / T \times 100 = ton \times fosc \times 100$$

$$topen \leq toff$$

In Equation 1, “V_{OUT} × topen / L” shows the amount of current change in “OFF” state. Also, “(V_{IN} - V_{OUT}) × ton / L” shows the amount of current change at “ON” state.

Discontinuous Mode and Continuous Mode

As illustrated in Figure 3. when I_{OUT} is relatively small, $t_{open} < t_{off}$. In this case, the energy charged into L during t_{on} will be completely discharged during t_{off} , as a result, $I_{LMIN} = 0$. This is called discontinuous mode. When I_{OUT} is gradually increased, eventually $t_{open} = t_{off}$ and when I_{OUT} is increased further, eventually $I_{LMIN} > 0$. This is called continuous mode.

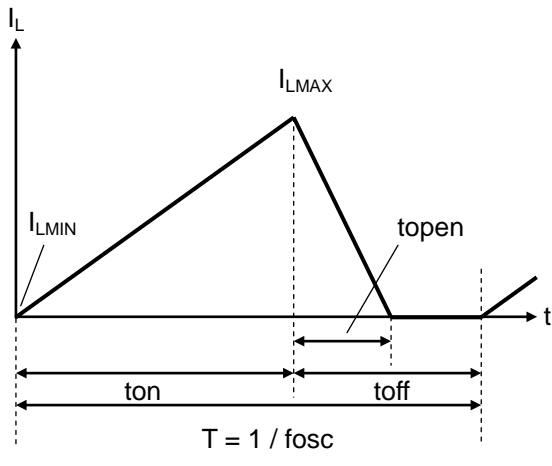
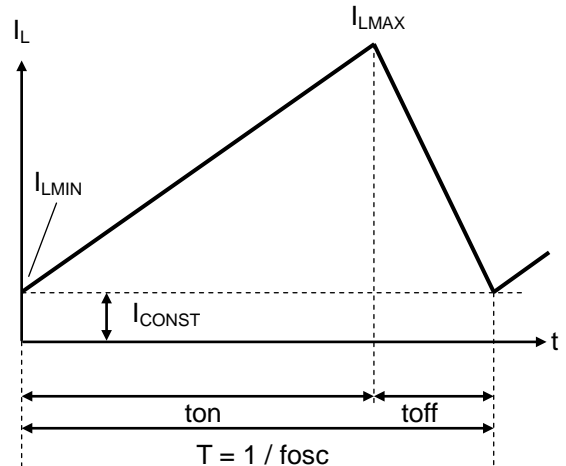
**Figure 3. Discontinuous Mode****Figure 4. Continuous Mode**

In the continuous mode, the solution of Equation 1 is described as t_{onc} .

$$t_{onc} = T \times V_{OUT} / V_{IN} \dots\dots\dots \text{Equation 2}$$

When $t_{on} < t_{onc}$, it indicates discontinuous mode, and when $t_{on} \geq t_{onc}$, it indicates continuous mode.

Forced PWM Mode

By setting the MODE pin to "H", the RP508K switches on/off at the fixed frequency to reduce noise even under the light load. When I_{OUT} is $\Delta I_L / 2$ or less, I_{LMIN} becomes less than 0. That is, the accumulated electricity in CL is discharged through the IC side at I_L increase period from I_{LMIN} to "0" during t_{on} and at I_L decrease period from "0" to I_{LMIN} during t_{off}.

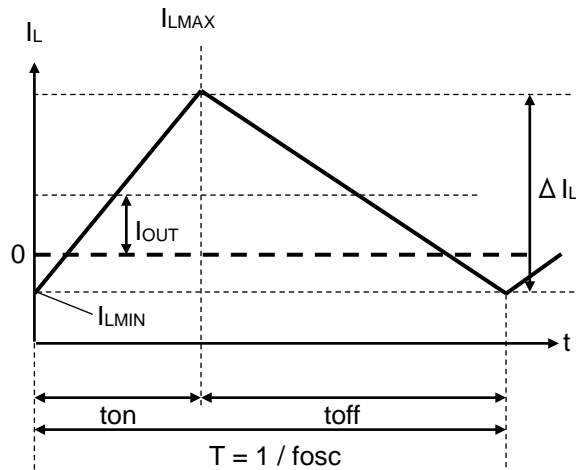

Forced PWM Mode

VFM MODE

By setting the MODE pin to "L", in low output current, the IC automatically switches into VFM mode in order to achieve high efficiency. In VFM mode, a value of t_{on} is determined by V_{IN} and V_{OUT}.

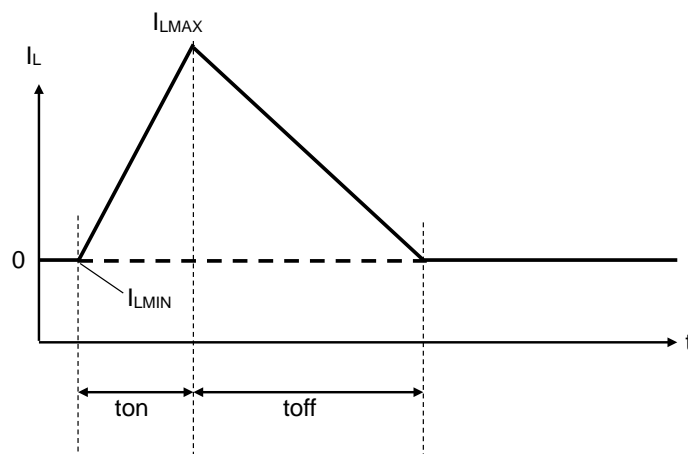

VFM Mode

Timing Chart

1. Soft-Start Time

Starting-up with CE Pin

The IC starts to operate when the CE pin voltage (V_{CE}) exceeds the threshold voltage. The threshold voltage is preset between CE "H" input voltage (V_{CEH}) and CE "L" input voltage (V_{CEL}).

After the start-up of the IC, soft-start circuit starts to operate. Then, after a certain period of time, the reference voltage (V_{REF}) in the IC gradually increases up to the specified value.

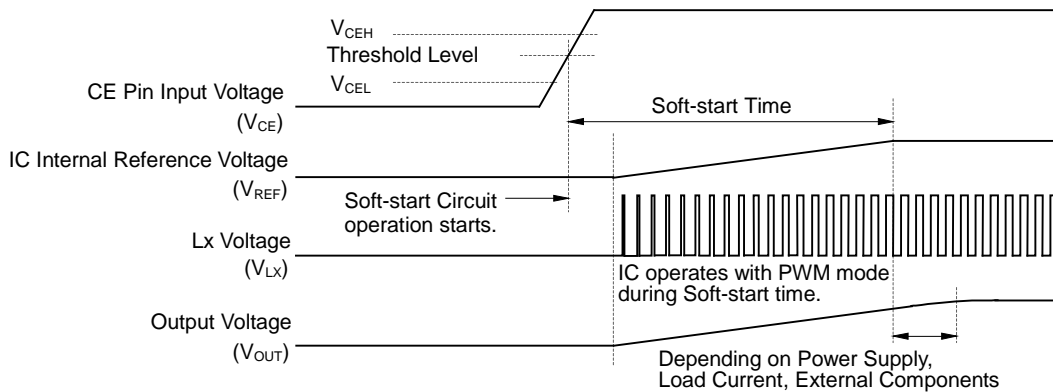

Soft-start time starts when soft-start circuit is activated, and ends when the reference voltage reaches the specified voltage. Soft start time is not always equal to the turn-on speed of the step-down DC/DC converter. Note that the turn-on speed could be affected by the power supply capacity, the output current, the inductance value and the C_{OUT} value.

Starting-up with Power Supply

After the power-on, when V_{IN} exceeds the UVLO released voltage (V_{UVLO2}), the IC starts to operate. Then, soft-start circuit starts to operate and after a certain period of time, V_{REF} gradually increases up to the specified value. Soft-start time starts when soft-start circuit is activated, and ends when V_{REF} reaches the specified voltage.

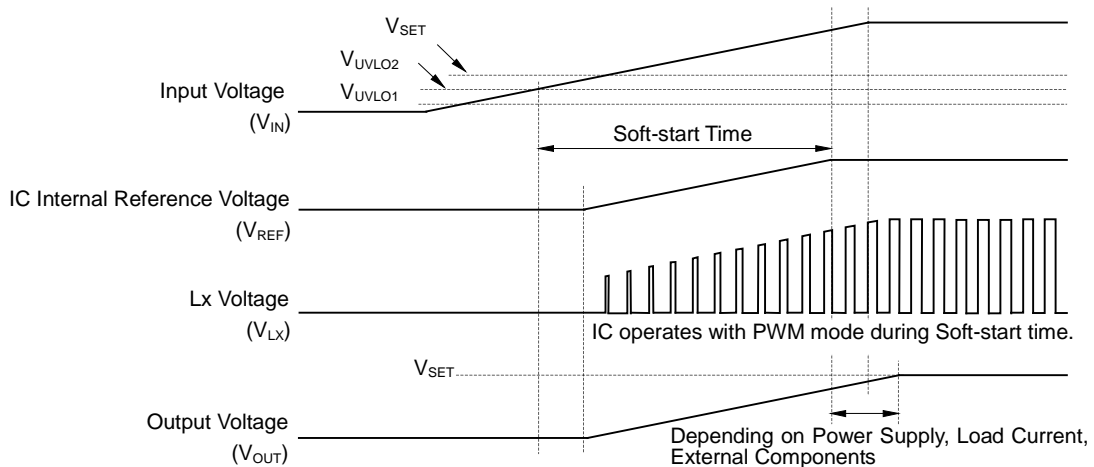

Note that the turn-on speed of V_{OUT} could be affected by the power supply capacity, the output current, the inductance value, the C_{OUT} value and the turn-on speed of V_{IN} determined by C_{IN} .

2. Under Voltage Lockout (UVLO) Circuit

If V_{IN} becomes lower than V_{SET} , the step-down DC/DC converter stops the switching operation and ON duty becomes 100%, and then V_{OUT} gradually drops according to V_{IN} .

If the V_{IN} becomes lower than the UVLO detector threshold (V_{UVLO1}), the UVLO circuit starts to operate, V_{REF} stops, and P-channel and N-channel built-in switch transistors turn "OFF". As a result, V_{OUT} drops according to the C_{OUT} capacitance value and the load.

To restart the operation, V_{IN} needs to be higher than V_{UVLO2} . The timing chart below shows the voltage shifts of V_{REF} , V_{LX} and V_{OUT} when V_{IN} value is varied.

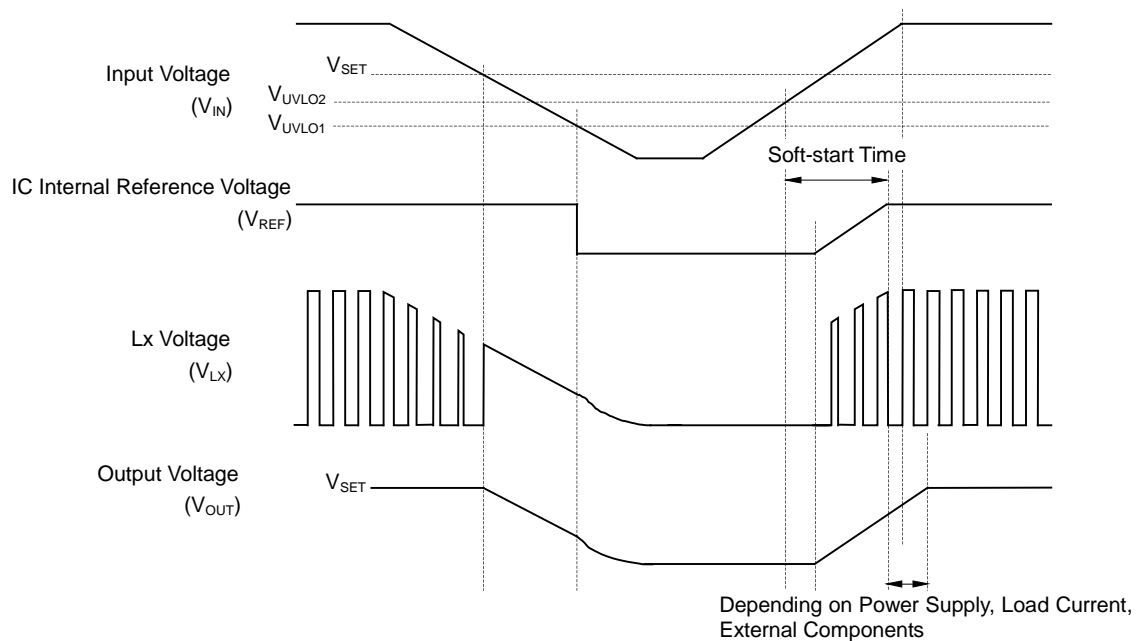

Falling edge (operating) and rising edge (releasing) waveforms of V_{OUT} could be affected by the initial voltage of C_{OUT} and the output current of V_{OUT} .

3. Over Current Protection Circuit

Over current protection circuit supervises the inductor peak current (the peak current flowing through P-channel Tr.) in each switching cycle. If the current exceeds the L_X current limit (I_{LXLIM}) of 1100 mA (Typ.), P-channel Tr. is turned off.

I_{LXLIM} could be easily affected by self-heating or ambient environment. If the V_{IN} drops dramatically or becomes unstable due to short-circuit, protection operation could be affected.

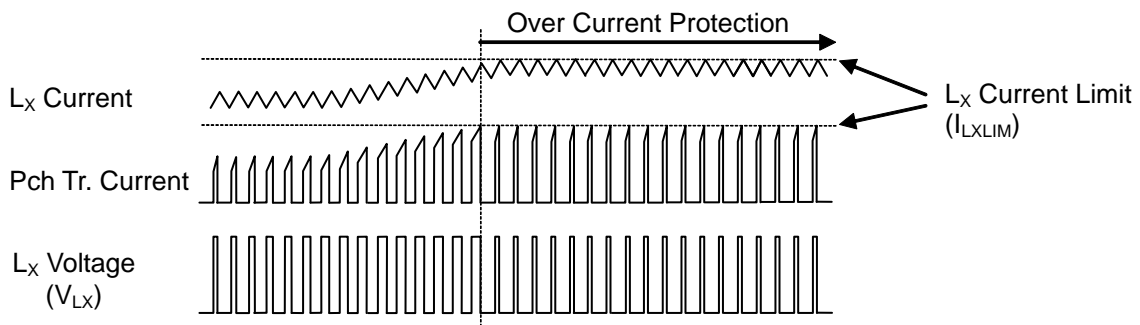

APPLICATION INFORMATION

Typical Application

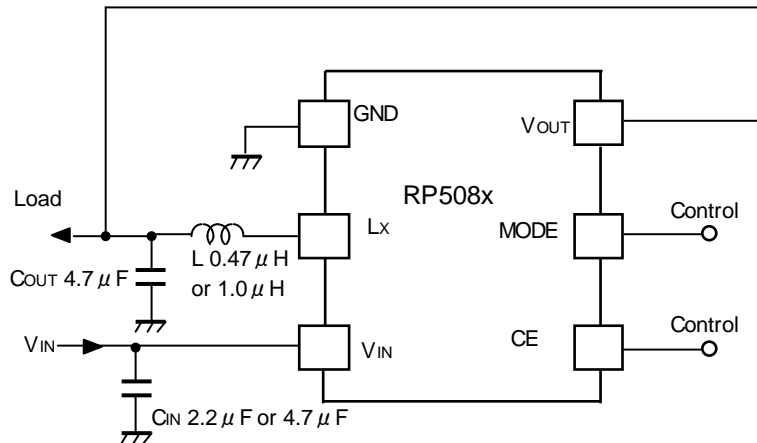

RP508K Typical Application

Recommended Components

Symbol	Size	Type	Manufacturer
C _{IN}	2.2 μF	Ceramic	C1005JB0J225K (TDK)
	4.7 μF	Ceramic	C1005JB0J475K (TDK)
C _{OUT}	4.7 μF	Ceramic	C1005JB0J475K (TDK)
L	0.47 μH (0.5 μH)	Inductor	MIPSZ2012D0R5 (FDK)
			MDT1608CHR47N (TOKO)
	1.0 μH	Inductor	MIPSZ2012D1R0 (FDK)
			MDT1608CH1R0N (TOKO)

Cautions in Selecting External Components

- Ensure the V_{IN} and GND lines are sufficiently robust. A large switching current flows through the GND lines, the V_{DD} line, the V_{OUT} line, an inductor, and L_X . If their impedance is too high, noise pickup or unstable operation may result. Set the external components as close as possible to the IC and minimize the wiring between the components and the IC, especially between a capacitor (C_{IN}) and the V_{IN} pin. The wiring between V_{OUT} and load and between L and V_{OUT} should be separated.
- Choose a low ESR ceramic capacitor. The capacitance of C_{IN} should be more than or equal to 2.2 μF . The capacitance of a capacitor (C_{OUT}) should be between 4.7 μF to 10 μF .
- The Inductance value should be set within the range of 0.47 μH to 1.0 μH . However, the inductance value is limited by output voltage. Refer to the table below. The phase compensation of this IC is designed according to the C_{OUT} and L values. Choose an inductor that has small DC resistance, has enough allowable current and is hard to cause magnetic saturation. If the inductance value of an inductor is extremely small, the peak current of L_X may increase. The increased L_X peak current reaches “ L_X limit current” to trigger over current protection circuit even if the load current is less than 600 mA.

Set Output Voltage Range vs. Inductance Range

Set Output Voltage (V)	Input Voltage (V)	Inductance	
		L = 0.47 μH	L = 1.0 μH
V_{SET} 0.8 to 1.2	up to 5.5	Recommended	Acceptable
1.3 to 1.5	up to 4.5	Recommended	Acceptable
	4.5 to 5.5	Acceptable	Recommended
1.6 to 2.6	up to 3.6	Recommended	Acceptable
	up to 4.5	Acceptable	Recommended
	4.5 to 5.5	-	Recommended
2.7 to 3.3	up to 4.5	Recommended	Acceptable
	4.5 to 5.5	-	Recommended

- Over current protection circuit may be affected by self-heating or power dissipation environment.
- The performance of power source circuits using this IC largely depends on the peripheral circuits. When selecting the peripheral components, consider the conditions of use. Do not allow each component, PCB pattern and the IC to exceed their respected rated values (voltage, current and power) when designing the peripheral circuits.

Output Current and Selection of External Components

The following equations explain the relationship between output current and peripheral components used in the diagrams in *TYPICAL APPLICATIONS*.

Ripple Current P-P value is described as I_{RP} , ON resistance of P-channel Tr. is described as R_{ONP} , ON resistance of N-channel Tr. is described as R_{ONN} , and DC resistor of the inductor is described as R_L .

First, when P-channel Tr. Is "ON", the following equation is satisfied.

$$V_{IN} = V_{OUT} + (R_{ONP} + R_L) \times I_{OUT} + L \times I_{RP} / t_{on} \dots \dots \dots \text{Equation 3}$$

Second, when P-channel Tr. is "OFF" (N-channel Tr. Is "ON"), the following equation is satisfied.

$$L \times I_{RP} / t_{off} = R_{ONN} \times I_{OUT} + V_{OUT} + R_L \times I_{OUT} \dots \dots \dots \text{Equation 4}$$

Put Equation 4 into Equation 3 to solve ON duty of P-channel Tr. ($D_{ON} = t_{on} / (t_{off} + t_{on})$):

$$D_{ON} = (V_{OUT} + R_{ONN} \times I_{OUT} + R_L \times I_{OUT}) / (V_{IN} + R_{ONN} \times I_{OUT} - R_{ONP} \times I_{OUT}) \dots \dots \dots \text{Equation 5}$$

Ripple Current is described as follows:

$$I_{RP} = (V_{IN} - V_{OUT} - R_{ONP} \times I_{OUT} - R_L \times I_{OUT}) \times D_{ON} / f_{osc} / L \dots \dots \dots \text{Equation 6}$$

Peak current that flows through L, and L_X Tr. is described as follows:

$$I_{LXMAX} = I_{OUT} + I_{RP} / 2 \dots \dots \dots \text{Equation 7}$$

Consider I_{LXMAX} when setting conditions of input and output, as well as selecting the external components. The above calculation formulas are based on the ideal operation of the I_{CS} in continuous mode.

TECHNICAL NOTES

The performance of power source circuits using this IC largely depends on the peripheral circuits. When selecting the peripheral components, consider the conditions of use. Do not allow each component, PCB pattern and the IC to exceed their respected rated values (voltage, current and power) when designing the peripheral circuits.

- Ensure the V_{IN} and GND lines are sufficiently robust. A large switching current flows through the GND lines, the V_{DD} line, the V_{OUT} line, an inductor, and L_x . If their impedance is too high, noise pickup or unstable operation may result. Set the external components as close as possible to the IC and minimize the wiring between the components and the IC, especially between a capacitor (C_{IN}) and the V_{IN} pin. The wiring between V_{OUT} and load and between L and V_{OUT} should be separated.

Reference PCB Layout

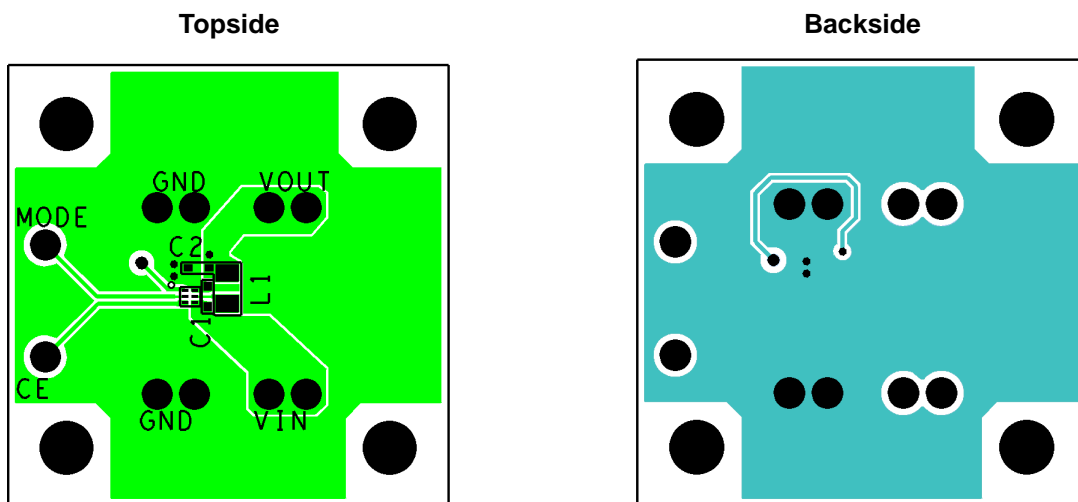

DFN1212-6 Typical Board Layout

TYPICAL CHARACTERISTICS

Note: Typical Characteristics are intended to be used as reference data; they are not guaranteed.

01) Output Voltage vs. Output Current

RP508K081x, $V_{OUT} = 0.8\text{ V}$

MODE = "L" PWM/VFM auto switching control

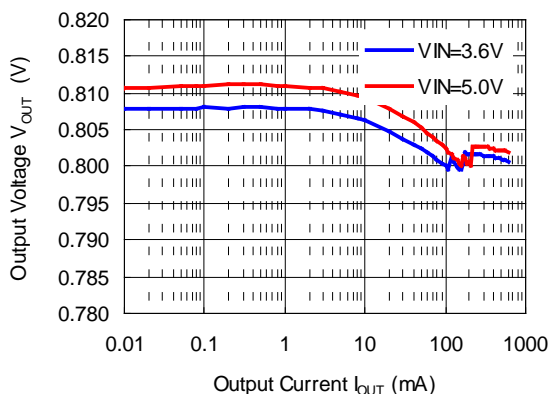

RP508K081x, $V_{OUT} = 0.8\text{ V}$

MODE = "H" forced PWM control

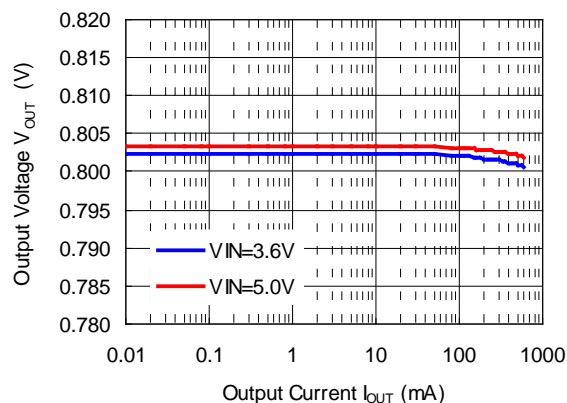

RP508K101x, $V_{OUT} = 1.0\text{ V}$

MODE = "L" PWM/VFM auto switching control

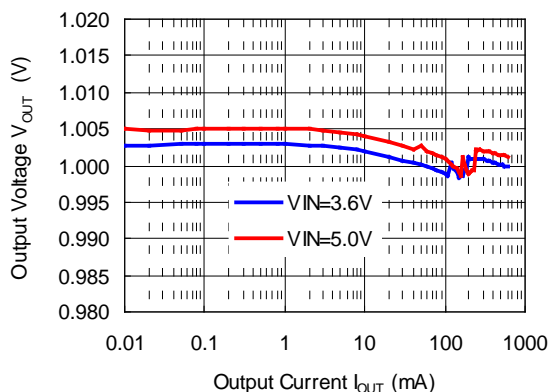

RP508K101x, $V_{OUT} = 1.0\text{ V}$

MODE = "H" forced PWM control

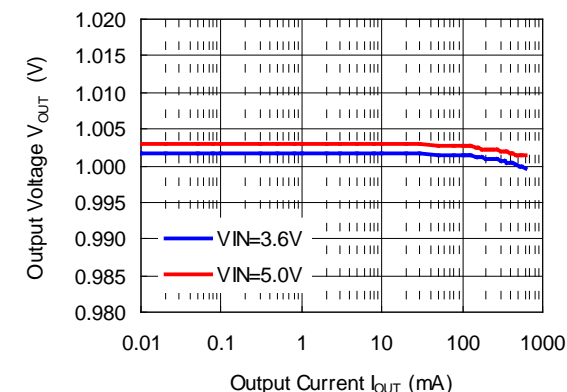

RP508K121x, $V_{OUT} = 1.2\text{ V}$

MODE = "L" PWM/VFM auto switching control

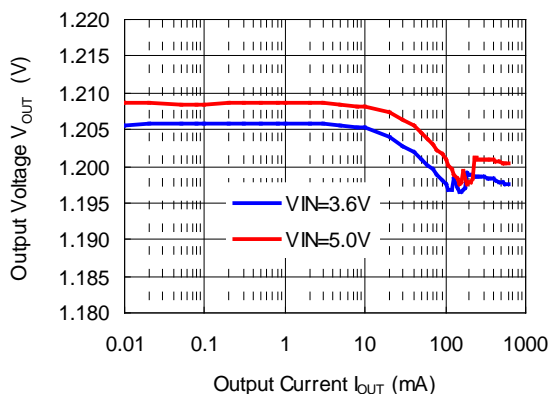

RP508K121x, $V_{OUT} = 1.2\text{ V}$

MODE = "H" forced PWM control

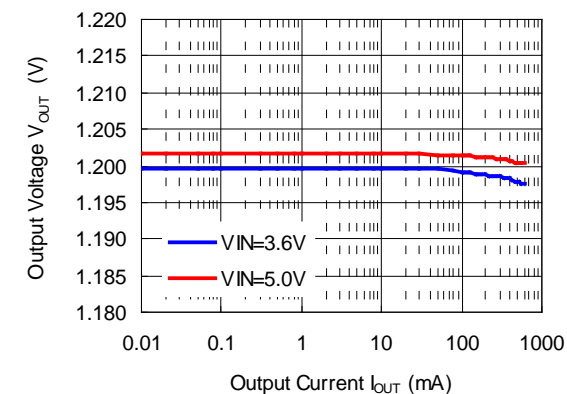

RP508K

NO. EA-318-171106

RP508K181x, $V_{OUT} = 1.8\text{ V}$
MODE = "L" PWM/VFM auto switching control

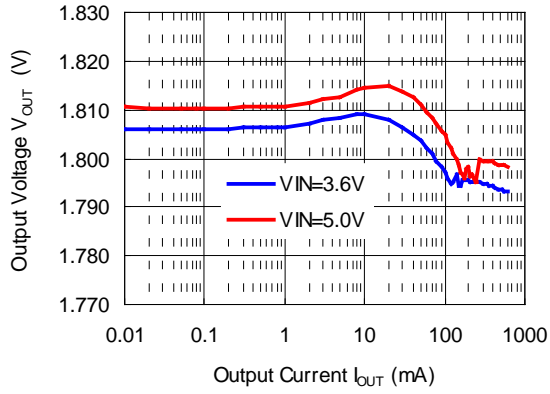

RP508K181x, $V_{OUT} = 1.8\text{ V}$
MODE = "H" forced PWM control

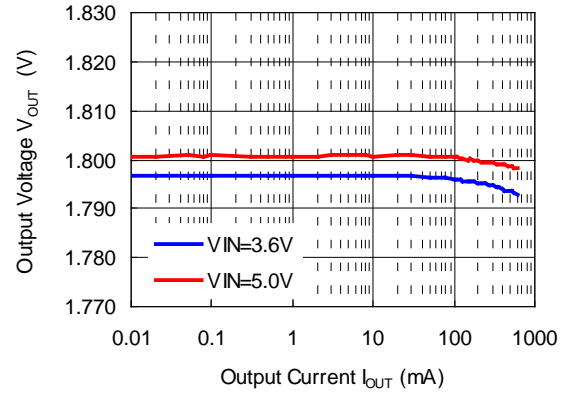

RP508K331x, $V_{OUT} = 3.3\text{ V}$
MODE = "L" PWM/VFM auto switching control

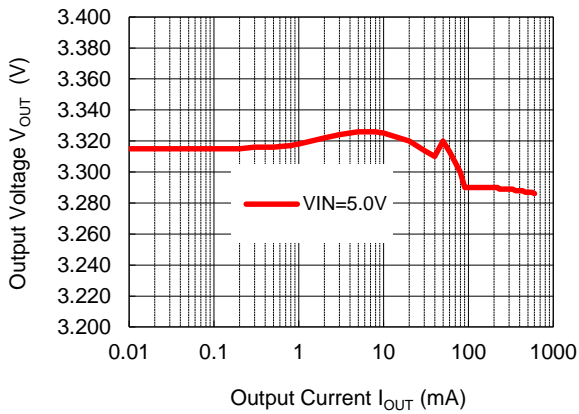

RP508K331x, $V_{OUT} = 3.3\text{ V}$
MODE = "H" forced PWM control

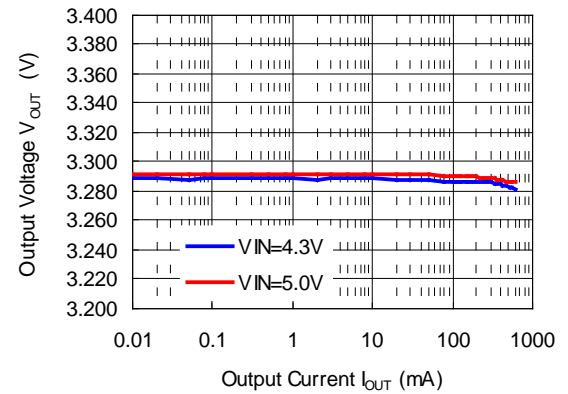

02) Output Voltage vs. Input Voltage

RP508K081x, $V_{OUT} = 0.8\text{ V}$
MODE = "H" forced PWM control

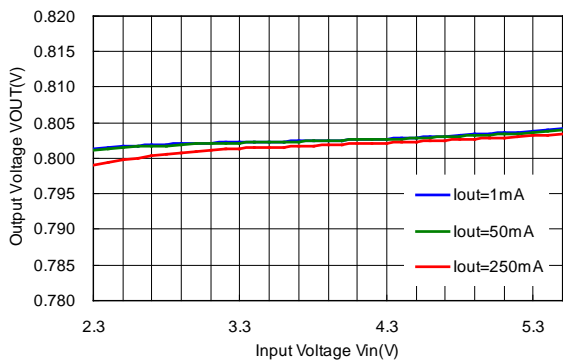

RP508K101x, $V_{OUT} = 1.0\text{ V}$
MODE = "H" forced PWM control

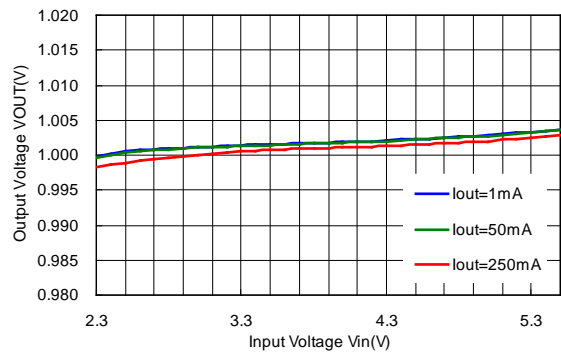

RP508K121x, $V_{OUT} = 1.2\text{ V}$
 MODE = "H" forced PWM control

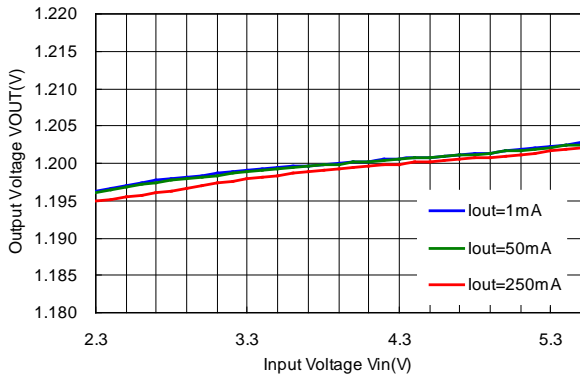

RP508K181x, $V_{OUT} = 1.8\text{ V}$
 MODE = "H" forced PWM control

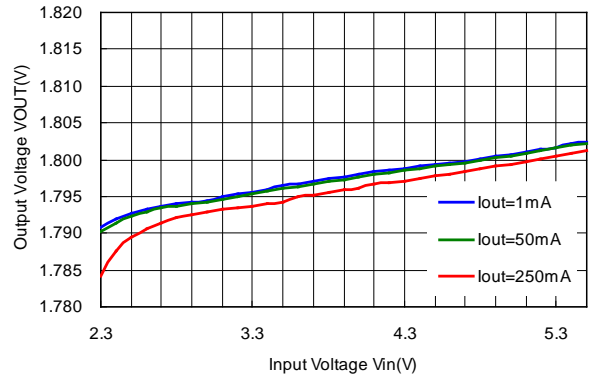

RP508K331x, $V_{OUT} = 3.3\text{ V}$
 MODE = "H" forced PWM control

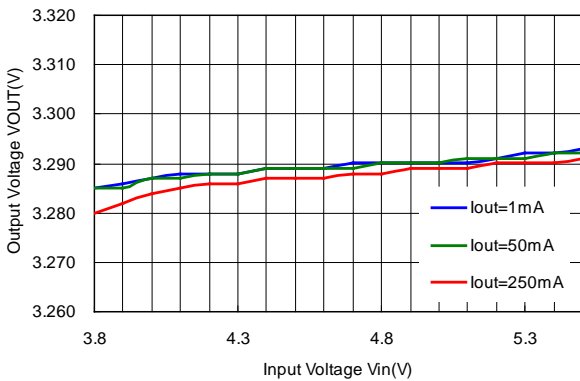

03) Output Voltage vs. Temperature

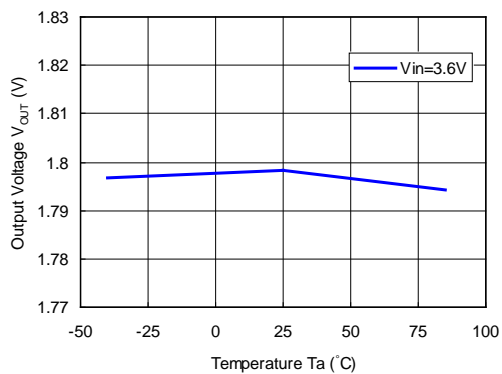

RP508K

NO. EA-318-171106

04) Efficiency vs. Output Current

RP508K081x, $V_{OUT} = 0.8\text{ V}$
L = MIPSZ2012D0R5 (2012size_0.5 μH)

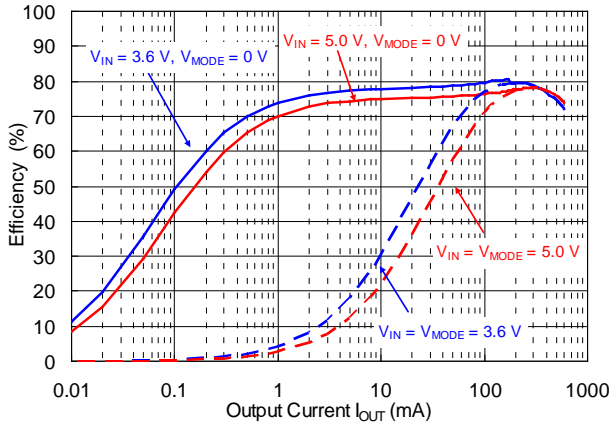

RP508K101x, $V_{OUT} = 1.0\text{ V}$
L = MIPSZ2012D0R5 (2012size_0.5 μH)

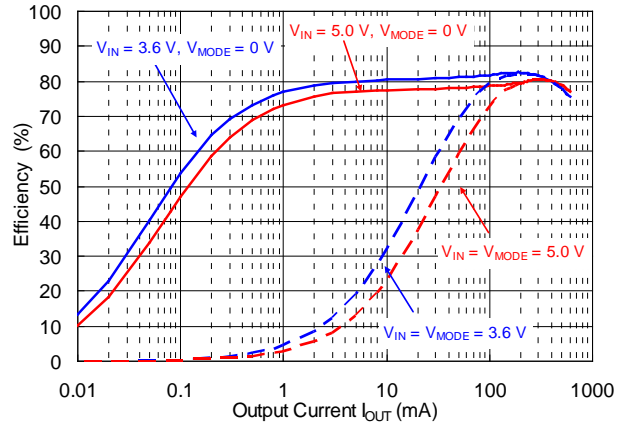

RP508K121x, $V_{OUT} = 1.2\text{ V}$
L = MIPSZ2012D0R5 (2012size_0.5 μH)

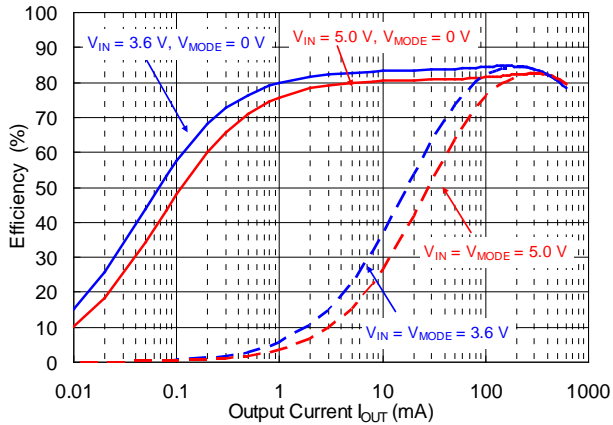

RP508K181x, $V_{OUT} = 1.8\text{ V}$
L = MIPSZ2012D0R5 (2012size_0.5 μH)

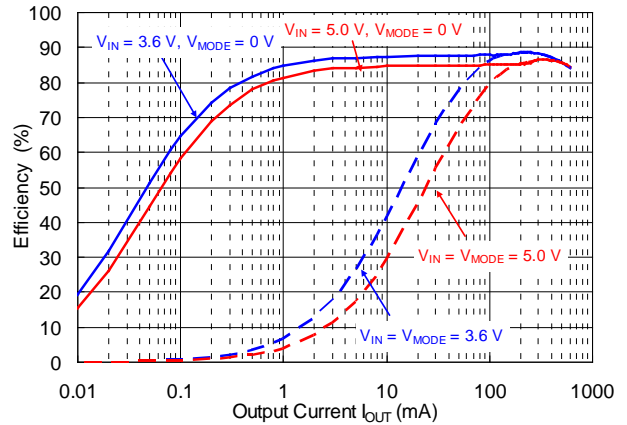

RP508K331x, $V_{OUT} = 3.3\text{ V}$
L = MIPSZ2012D1R0 (2012size_1.0 μH)

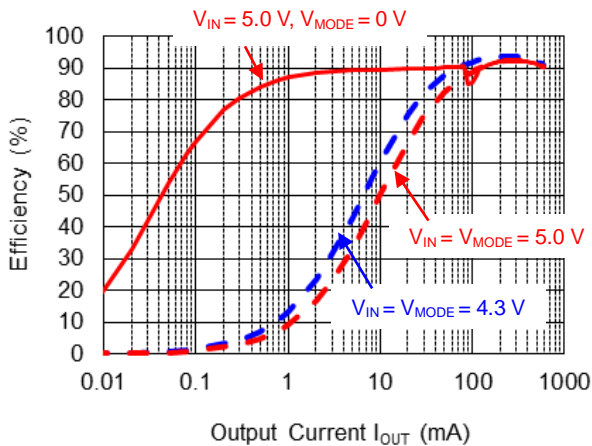

RP508K081x, $V_{OUT} = 0.8\text{ V}$
 $L = \text{MDT1608CHR47N}$ (1608size_0.47 μH)

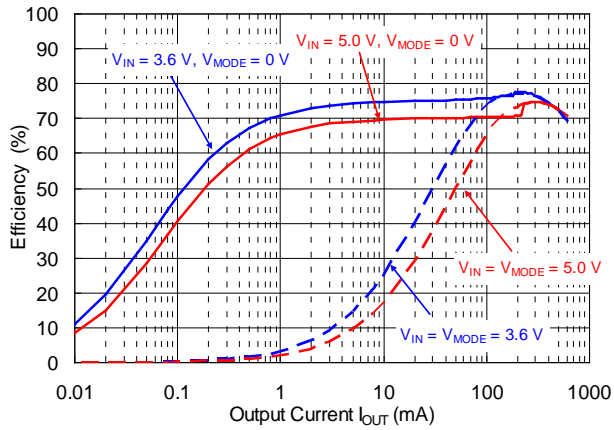

RP508K101x, $V_{OUT} = 1.0\text{ V}$
 $L = \text{MDT1608CHR47N}$ (1608size_0.47 μH)

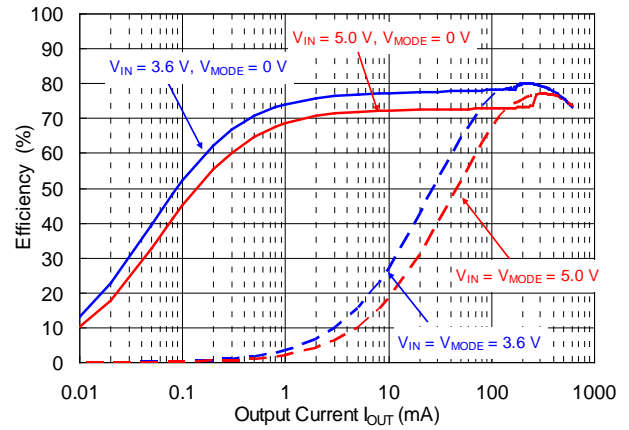

RP508K121x, $V_{OUT} = 1.2\text{ V}$
 $L = \text{MDT1608CHR47N}$ (1608size_0.47 μH)

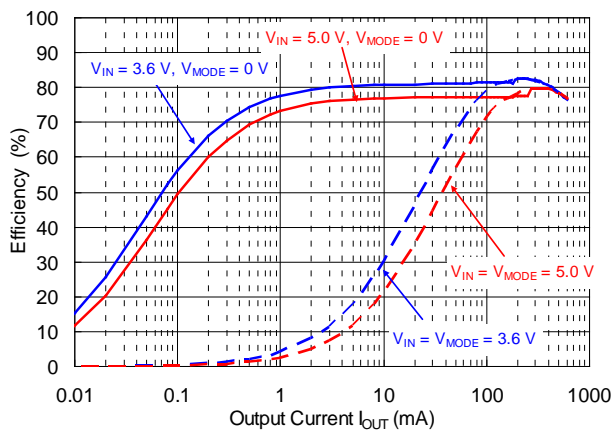

RP508K181x, $V_{OUT} = 1.8\text{ V}$
 $L = \text{MDT1608CHR47N}$ (1608size_0.47 μH)

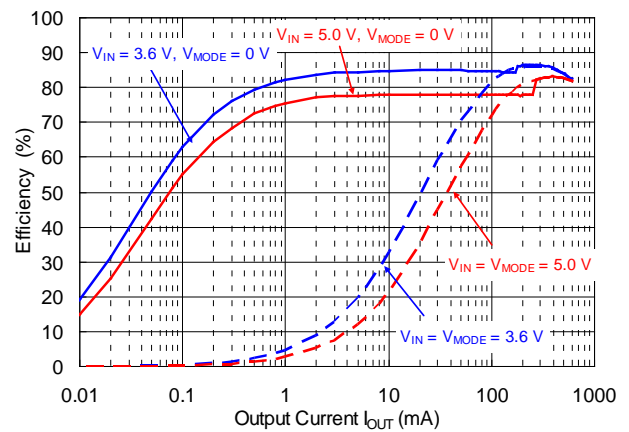

RP508K331x, $V_{OUT} = 3.3\text{ V}$
 $L = \text{MDT1608CH1R0N}$ (1608size_1.0 μH)

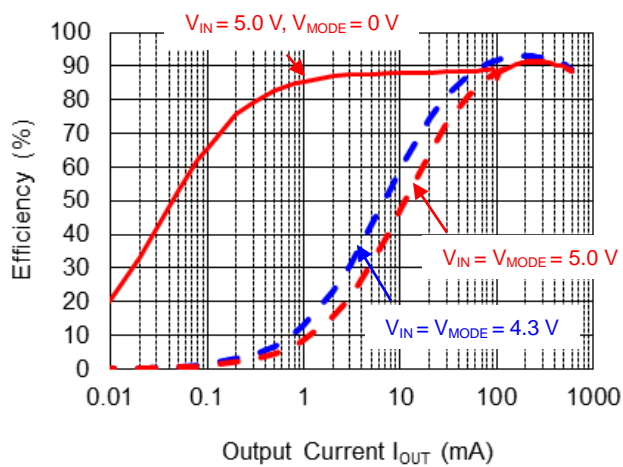

RP508K

NO. EA-318-171106

05) Supply Current vs. Temperature

RP508K181x, $V_{OUT} = 1.8\text{ V}$ ($V_{IN} = 5.5\text{ V}$)
MODE = "L" PWM/VFM auto switching control

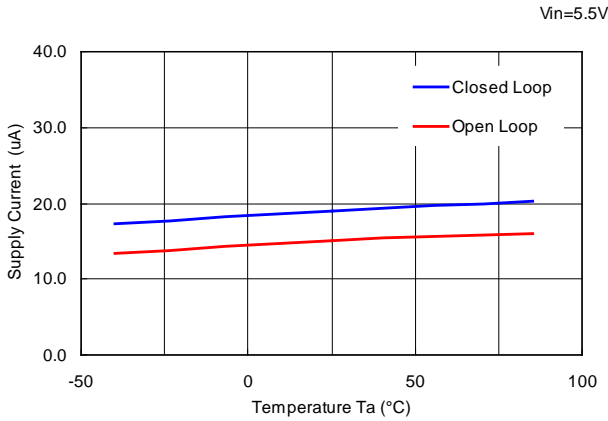

06) Supply Current vs. Input Voltage

RP508K181x, $V_{OUT} = 1.8\text{ V}$
MODE = "L" PWM/VFM auto switching control

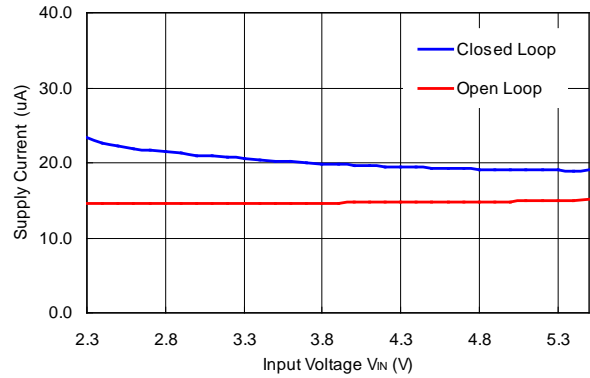

07) Output Voltage Waveform

RP508K081x, $V_{OUT} = 0.8\text{ V}$ ($V_{IN} = 3.6\text{ V}$)
MODE = "L" PWM/VFM auto switching control

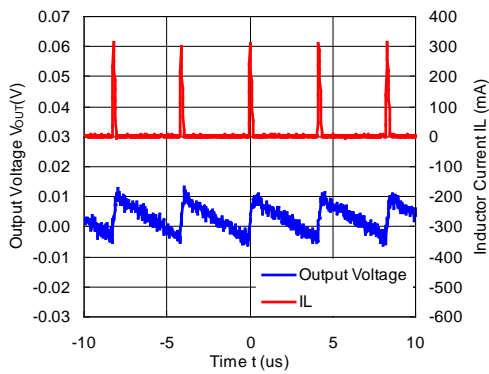

RP508K081x, $V_{OUT} = 0.8\text{ V}$ ($V_{IN} = 3.6\text{ V}$)
MODE = "H" forced PWM control

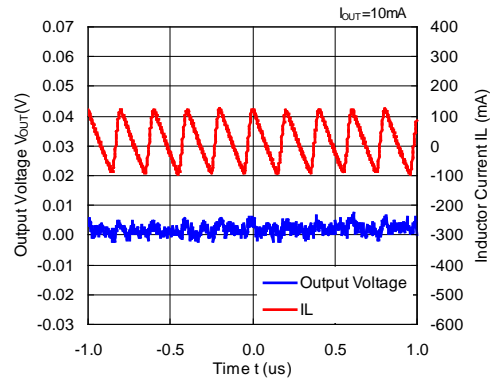

RP508K121x, $V_{OUT} = 1.2\text{ V}$ ($V_{IN} = 3.6\text{ V}$)
MODE = "L" PWM/VFM auto switching control

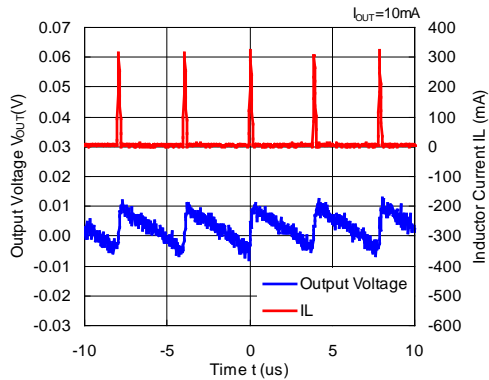

RP508K121x, $V_{OUT} = 1.2\text{ V}$ ($V_{IN} = 3.6\text{ V}$)
MODE = "H" forced PWM control

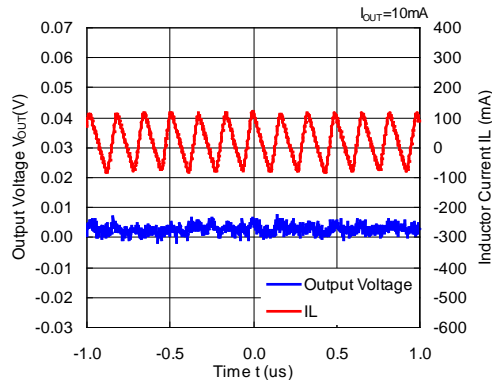

RP508K181x, $V_{OUT} = 1.8\text{ V}$ ($V_{IN} = 3.6\text{ V}$)
 MODE = "L" PWM/VFM auto switching control

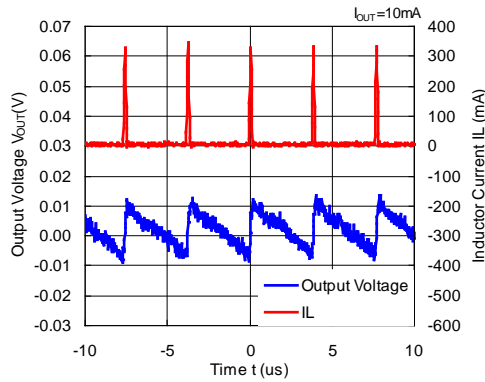

RP508K181x, $V_{OUT} = 1.8\text{ V}$ ($V_{IN} = 3.6\text{ V}$)
 MODE = "H" forced PWM control

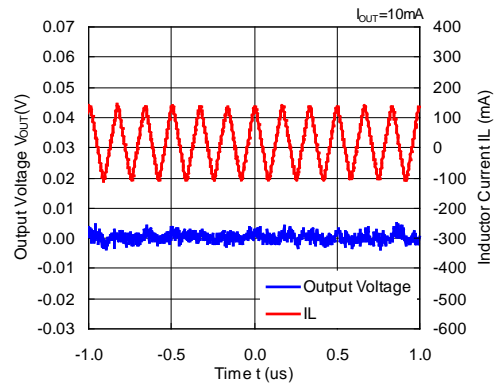

RP508K331x, $V_{OUT} = 3.3\text{ V}$ ($V_{IN} = 4.3\text{ V}$)
 MODE = "H" forced PWM control

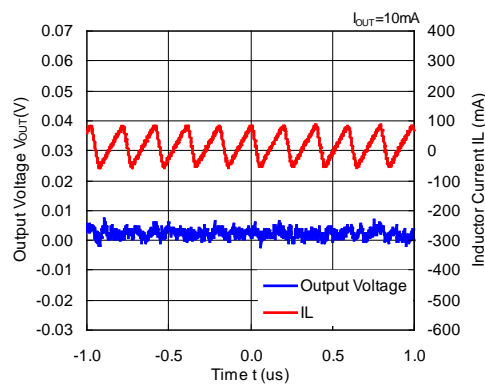

08) Frequency vs. Input Voltage

RP508K181x, $V_{OUT} = 1.8\text{ V}$
 MODE = "H" forced PWM control

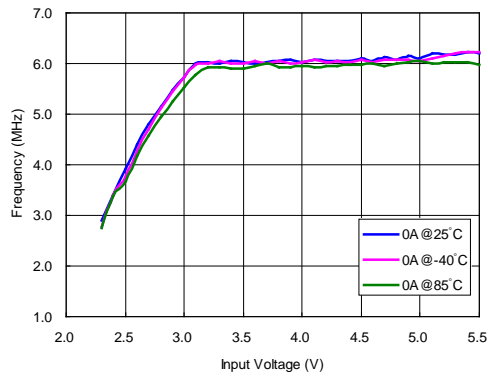

RP508K

NO. EA-318-171106

09) Frequency vs. Input Voltage with Various Output Currents

RP508K121x, $V_{OUT} = 1.2\text{ V}$
MODE = "H" forced PWM control

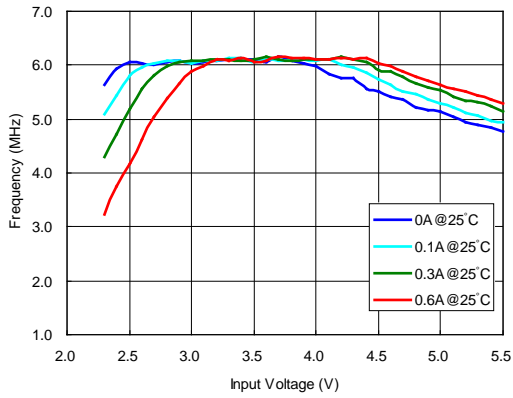

RP508K181x, $V_{OUT} = 1.8\text{ V}$
MODE = "H" forced PWM control

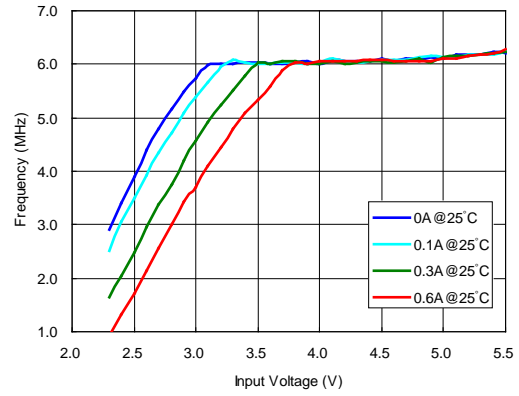

10) VFM Frequency vs. Output Current

RP508K121x, $V_{OUT} = 1.2\text{ V}$
MODE = "L" PWM/VFM auto switching control

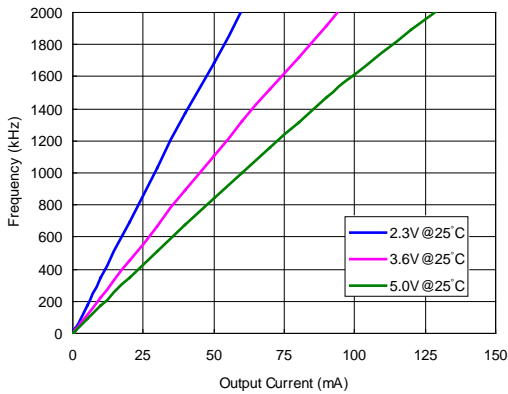

RP508K181x, $V_{OUT} = 1.8\text{ V}$
MODE = "L" PWM/VFM auto switching control

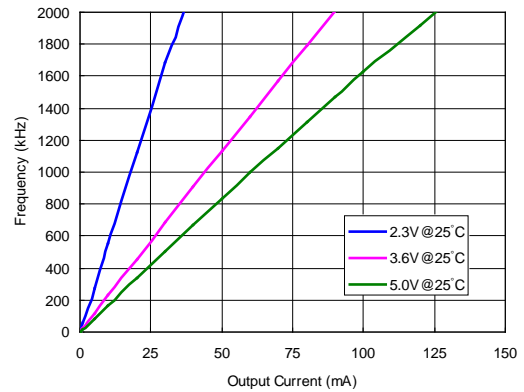

11) Soft-start Time vs. Temperature

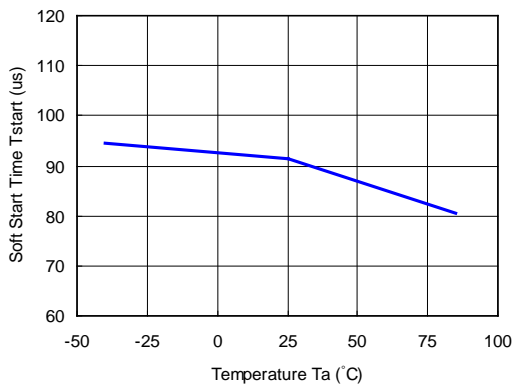

12) UVLO Detector Threshold/ Released Voltage vs. Temperature

UVLO Detector Threshold

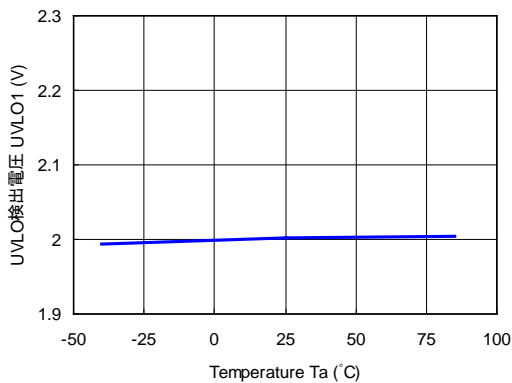

UVLO Release Voltage

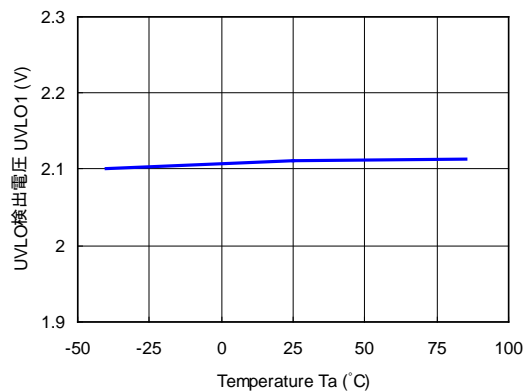

13) CE Input Voltage vs. Temperature

CE = "H" Input Voltage (V_{IN} = 5.5 V)

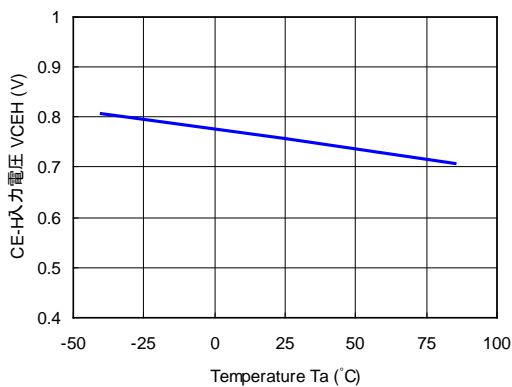

CE = "H" Input Voltage (V_{IN} = 2.3 V)

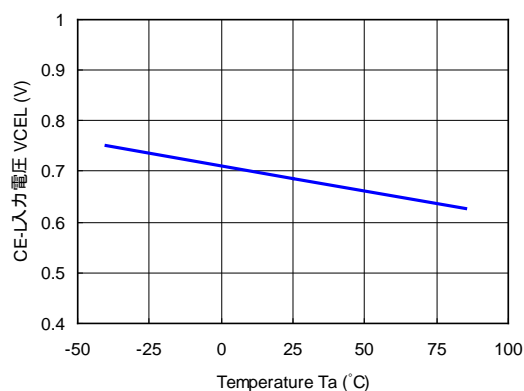

14) L_X Current Limit vs. Temperature

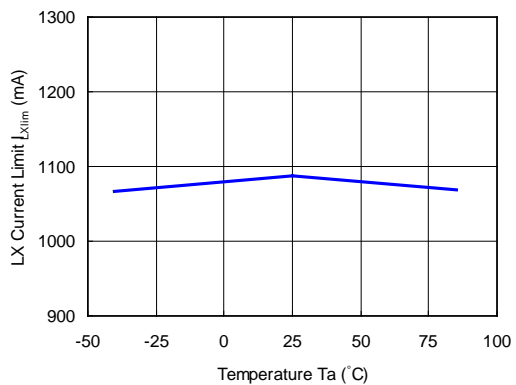

15) Standby Current vs. Temperature

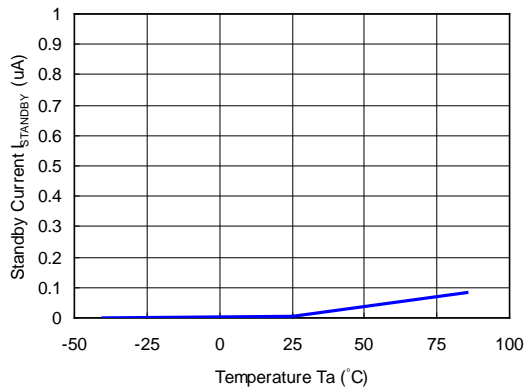

RP508K

NO. EA-318-171106

16) Nch Transistor On Resistance vs. Temperature

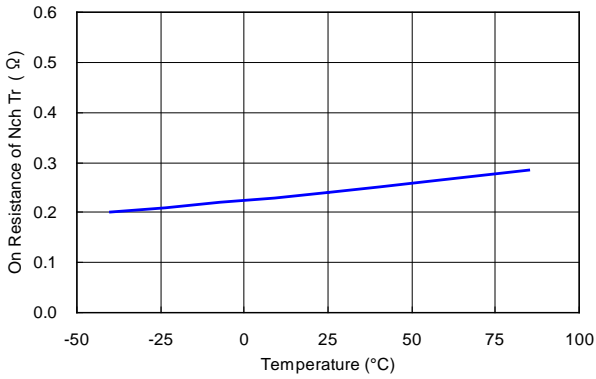

17) Pch Transistor On Resistance vs. Temperature

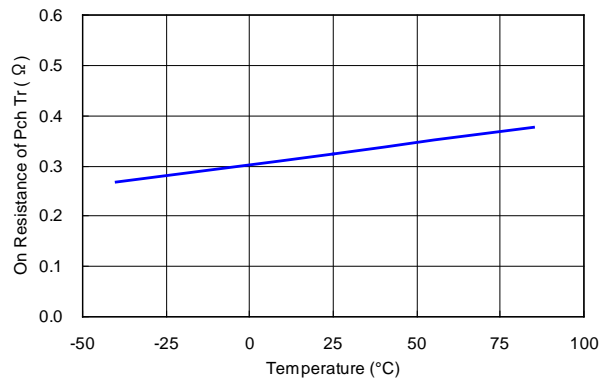

18) Load Transient Response ($C_{OUT} = 4.7 \mu\text{F}$, C1005X5R0J475M)

RP508K081x ($V_{IN} = 3.6 \text{ V}$, $V_{OUT} = 0.8 \text{ V}$)
L = MIPSZ2012D0R5 (2012size_0.5 μH)
MODE = "H" forced PWM control

RP508K081x ($V_{IN} = 3.6 \text{ V}$, $V_{OUT} = 0.8 \text{ V}$)
L = MIPSZ2012D0R5 (2012size_0.5 μH)
MODE = "H" forced PWM control

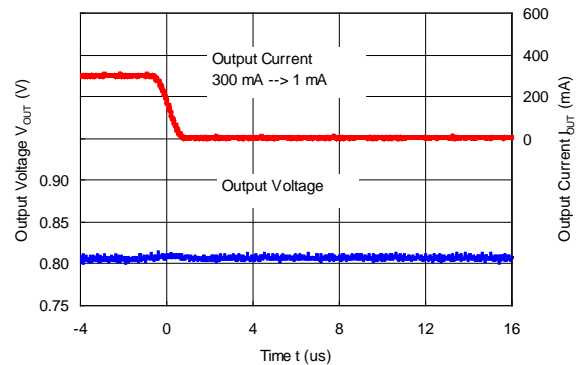
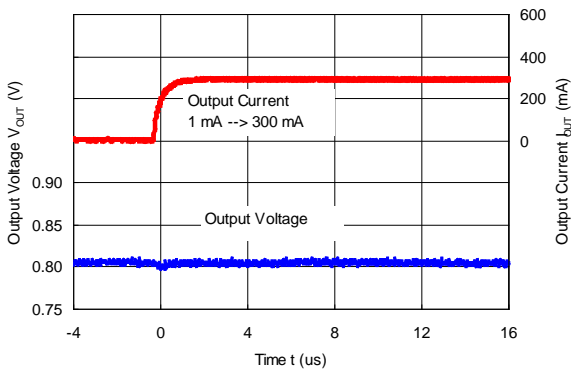

RP508K081x ($V_{IN} = 3.6 \text{ V}$, $V_{OUT} = 0.8 \text{ V}$)
L = MIPSZ2012D0R5 (2012size_0.5 μH)
MODE = "H" forced PWM control

RP508K081x ($V_{IN} = 3.6 \text{ V}$, $V_{OUT} = 0.8 \text{ V}$)
L = MIPSZ2012D0R5 (2012size_0.5 μH)
MODE = "H" forced PWM control

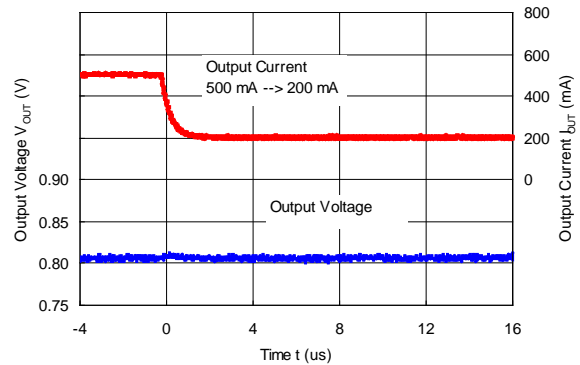
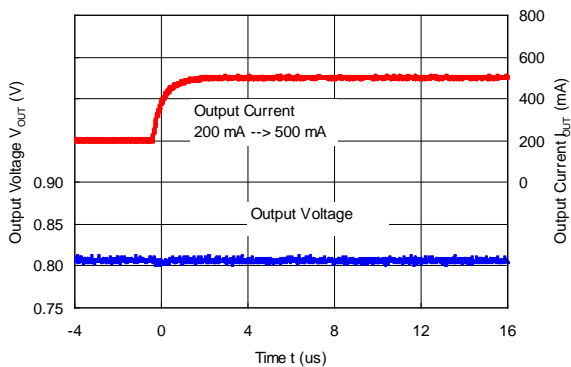

RP508K121x ($V_{IN} = 3.6\text{ V}$, $V_{OUT} = 1.2\text{ V}$)
 L = MIPSZ2012D0R5 (2012size_0.5 μH)
 MODE = "H" forced PWM control

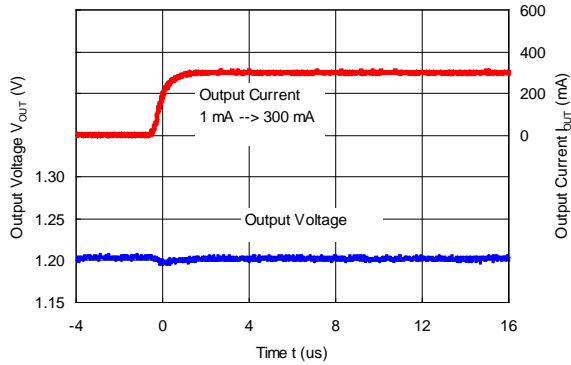

RP508K121x ($V_{IN} = 3.6\text{ V}$, $V_{OUT} = 1.2\text{ V}$)
 L = MIPSZ2012D0R5 (2012size_0.5 μH)
 MODE = "H" forced PWM control

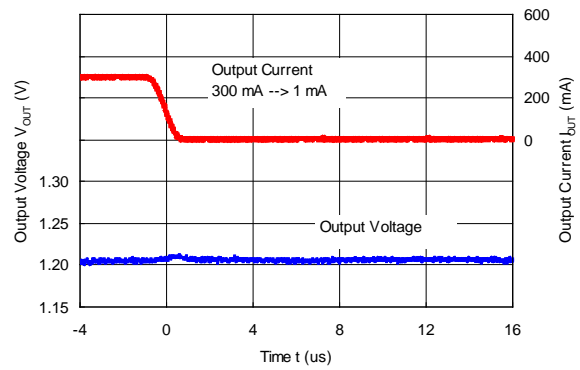

RP508K121x ($V_{IN} = 3.6\text{ V}$, $V_{OUT} = 1.2\text{ V}$)
 L = MIPSZ2012D0R5 (2012size_0.5 μH)
 MODE = "H" forced PWM control

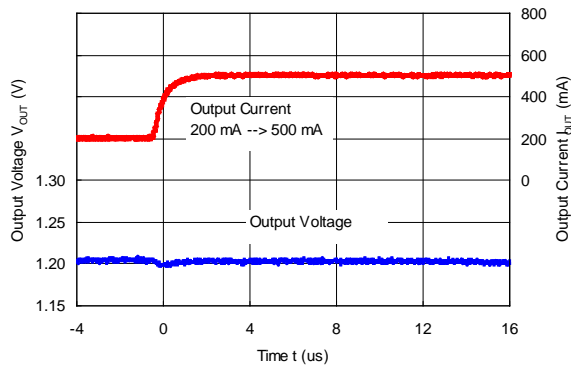

RP508K121x ($V_{IN} = 3.6\text{ V}$, $V_{OUT} = 1.2\text{ V}$)
 L = MIPSZ2012D0R5 (2012size_0.5 μH)
 MODE = "H" forced PWM control

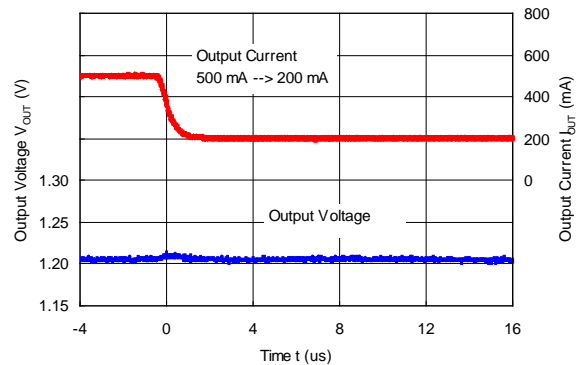

RP508K181x ($V_{IN} = 3.6\text{ V}$, $V_{OUT} = 1.8\text{ V}$)
 L = MIPSZ2012D0R5 (2012size_0.5 μH)
 MODE = "H" forced PWM control

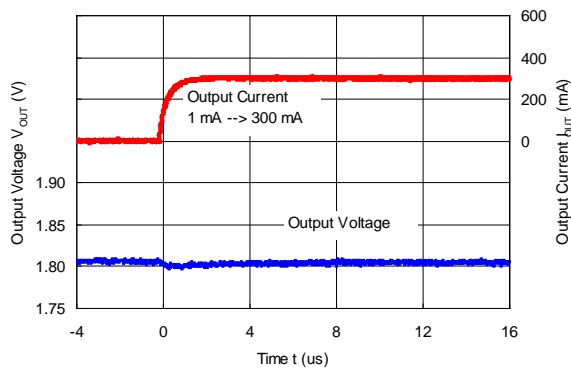

RP508K181x ($V_{IN} = 3.6\text{ V}$, $V_{OUT} = 1.8\text{ V}$)
 L = MIPSZ2012D0R5 (2012size_0.5 μH)
 MODE = "H" forced PWM control

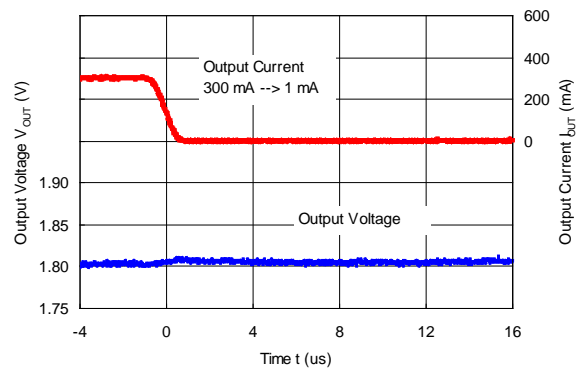

RP508K

NO. EA-318-171106

RP508K181x ($V_{IN} = 3.6\text{ V}$, $V_{OUT} = 1.8\text{ V}$)
L = MIPSZ2012D0R5 (2012size_0.5 μH)
MODE = "H" forced PWM control

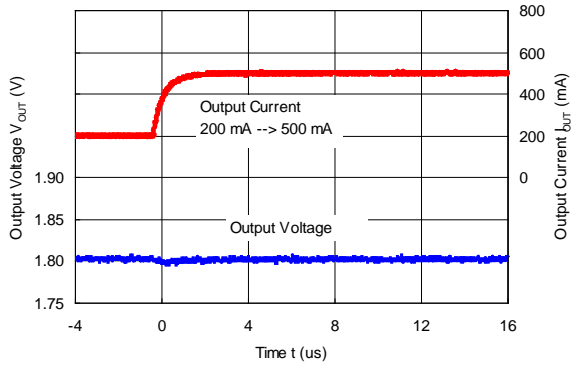

RP508K181x ($V_{IN} = 3.6\text{ V}$, $V_{OUT} = 1.8\text{ V}$)
L = MIPSZ2012D0R5 (2012size_0.5 μH)
MODE = "H" forced PWM control

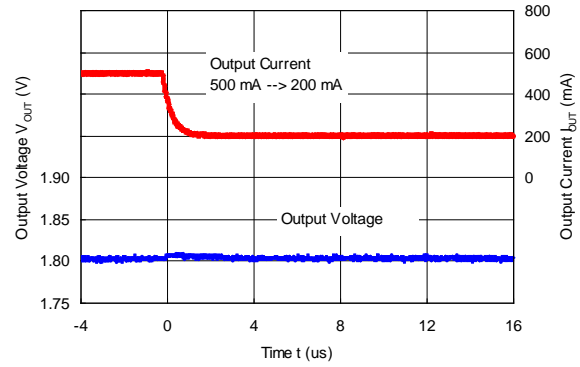

RP508K331x ($V_{IN} = 5.0\text{ V}$, $V_{OUT} = 3.3\text{ V}$)
L = MIPSZ2012D1R0 (2012size_1.0 μH)
MODE = "H" forced PWM control

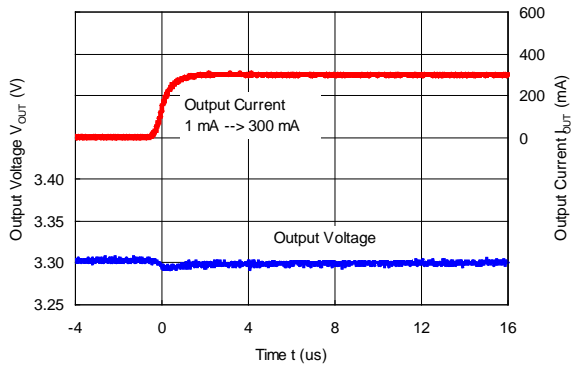

RP508K331x ($V_{IN} = 5.0\text{ V}$, $V_{OUT} = 3.3\text{ V}$)
L = MIPSZ2012D1R0 (2012size_1.0 μH)
MODE = "H" forced PWM control

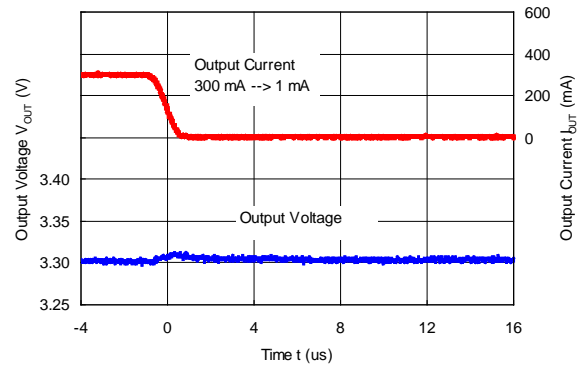

RP508K331x ($V_{IN} = 5.0\text{ V}$, $V_{OUT} = 3.3\text{ V}$)
L = MIPSZ2012D1R0 (2012size_1.0 μH)
MODE = "H" forced PWM control

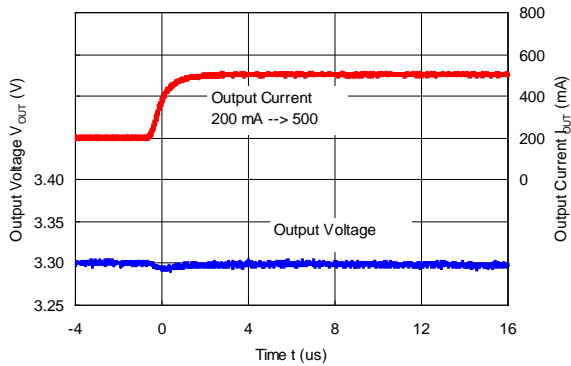

RP508K331x ($V_{IN} = 5.0\text{ V}$, $V_{OUT} = 3.3\text{ V}$)
L = MIPSZ2012D1R0 (2012size_1.0 μH)
MODE = "H" forced PWM control

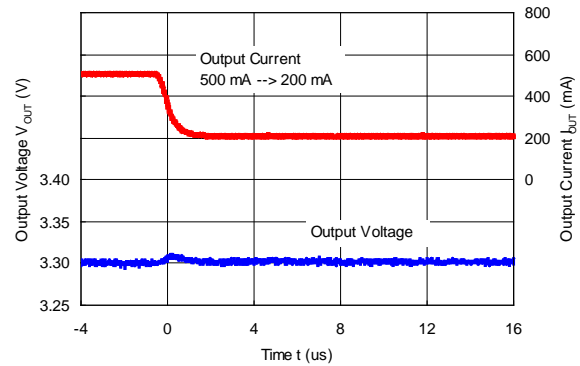

Load Transient Response ($C_{OUT} = 4.7\mu F, C1005X5R0J475M$)

RP508K081x ($V_{IN} = 3.6 V, V_{OUT} = 0.8 V$)
 L = MIPSZ2012D0R5 (2012size_0.5 μH)
 MODE = "L" PWM/VFM auto switching control

RP508K081x ($V_{IN} = 3.6 V, V_{OUT} = 0.8 V$)
 L = MIPSZ2012D0R5 (2012size_0.5 μH)
 MODE = "L" PWM/VFM auto switching control

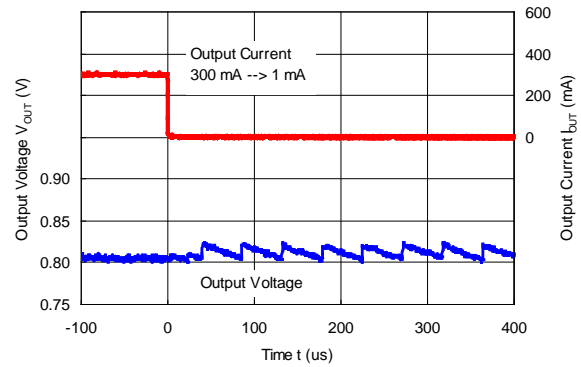
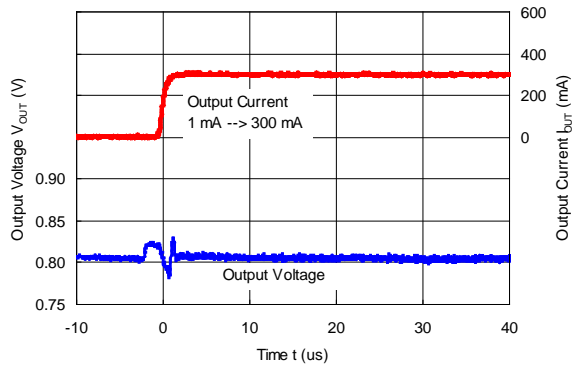

RP508K121x ($V_{IN} = 3.6 V, V_{OUT} = 1.2 V$)
 L = MIPSZ2012D0R5 (2012size_0.5 μH)
 MODE = "L" PWM/VFM auto switching control

RP508K121x ($V_{IN} = 3.6 V, V_{OUT} = 1.2 V$)
 L = MIPSZ2012D0R5 (2012size_0.5 μH)
 MODE = "L" PWM/VFM auto switching control

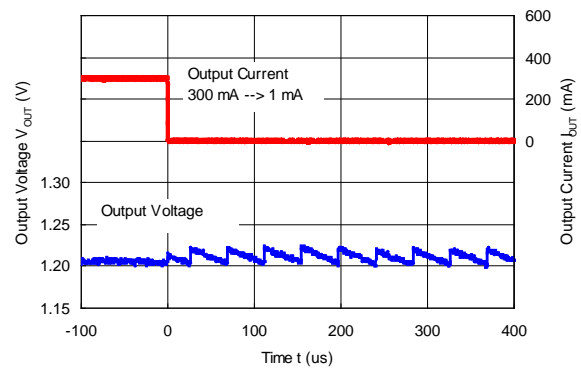
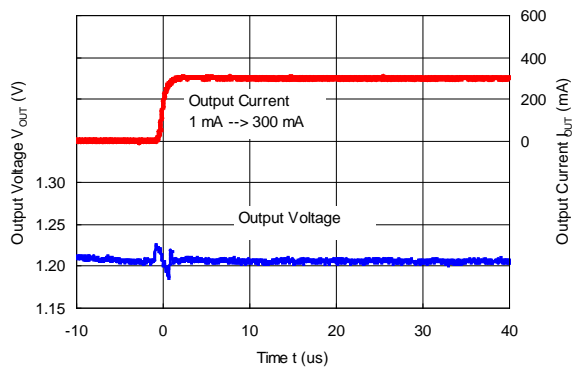

RP508K181x ($V_{IN} = 3.6 V, V_{OUT} = 1.8 V$)
 L = MIPSZ2012D0R5 (2012size_0.5 μH)
 MODE = "L" PWM/VFM auto switching control

RP508K181x ($V_{IN} = 3.6 V, V_{OUT} = 1.8 V$)
 L = MIPSZ2012D0R5 (2012size_0.5 μH)
 MODE = "L" PWM/VFM auto switching control

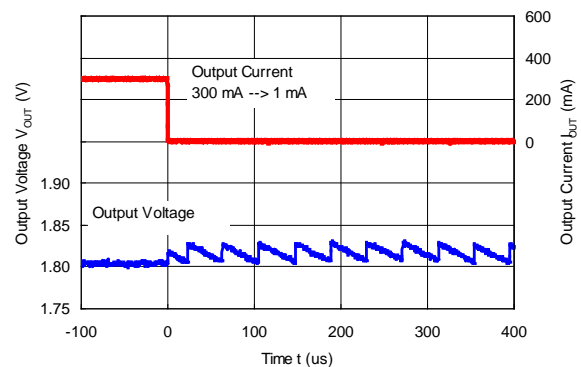
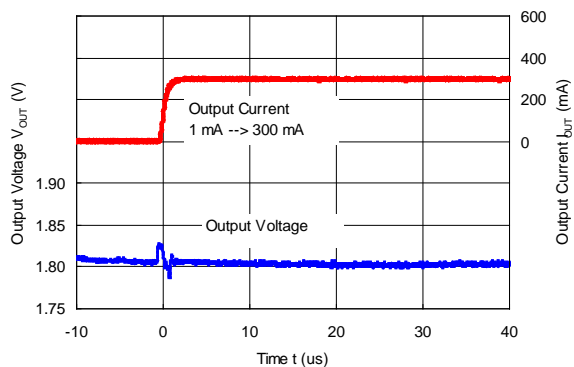

RP508K

NO. EA-318-171106

RP508K331x ($V_{IN} = 5.0\text{ V}$, $V_{OUT} = 3.3\text{ V}$)
 L = MIPSZ2012D1R0 (2012size_1.0 μH)
 MODE = "L" PWM/VFM auto switching control

RP508K331x ($V_{IN} = 5.0\text{ V}$, $V_{OUT} = 3.3\text{ V}$)
 L = MIPSZ2012D1R0 (2012size_1.0 μH)
 MODE = "L" PWM/VFM auto switching control

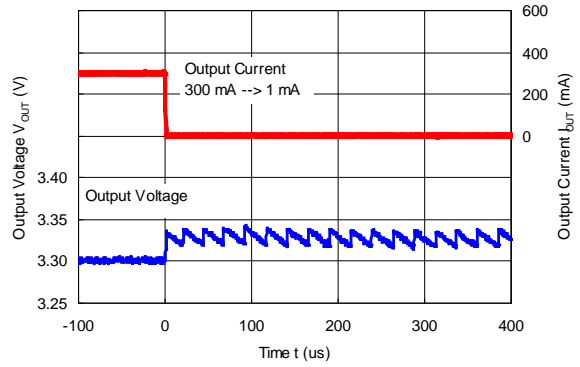
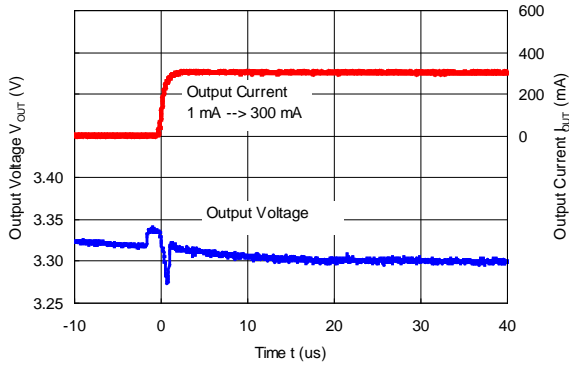

Load Transient Response ($C_{OUT} = 4.7\ \mu\text{F}$, C1005X5R0J475M)

RP508K081x ($V_{IN} = 3.6\text{ V}$, $V_{OUT} = 0.8\text{ V}$)
 L = MDT1608CHR47N (1608size_0.47 μH)
 MODE = "H" forced PWM control

RP508K081x ($V_{IN} = 3.6\text{ V}$, $V_{OUT} = 0.8\text{ V}$)
 L = MDT1608CHR47N (1608size_0.47 μH)
 MODE = "H" forced PWM control

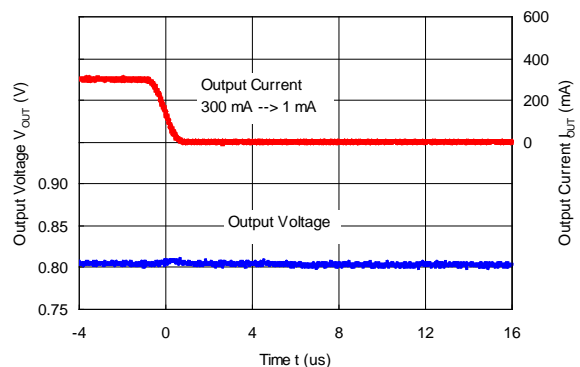
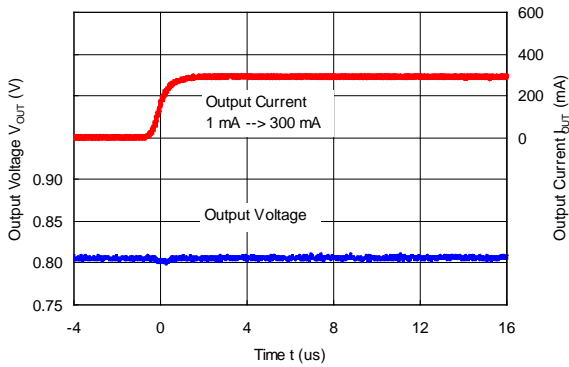

RP508K081x ($V_{IN} = 3.6\text{ V}$, $V_{OUT} = 0.8\text{ V}$)
 L = MDT1608CHR47N (1608size_0.47 μH)
 MODE = "H" forced PWM control

RP508K081x ($V_{IN} = 3.6\text{ V}$, $V_{OUT} = 0.8\text{ V}$)
 L = MDT1608CHR47N (1608size_0.47 μH)
 MODE = "H" forced PWM control

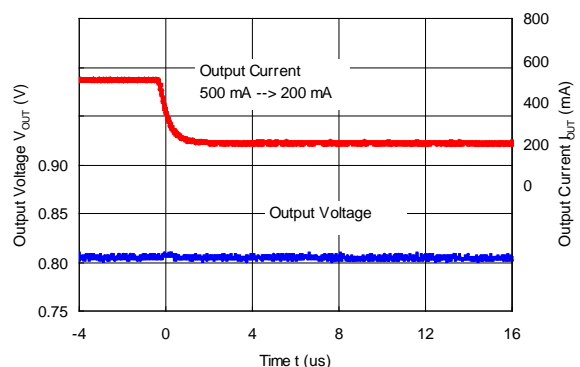
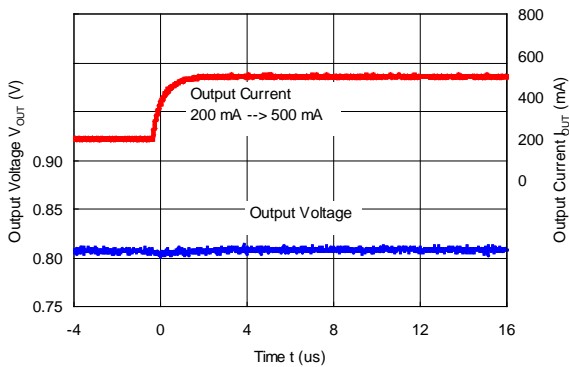

RP508K121x ($V_{IN} = 3.6\text{ V}$, $V_{OUT} = 1.2\text{ V}$)
 L = MDT1608CHR47N (1608size_0.47 μH)
 MODE = "H" forced PWM control

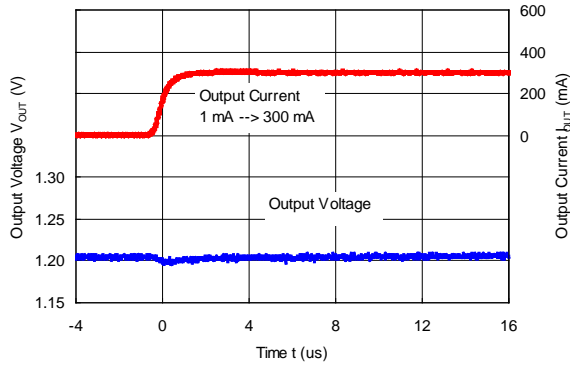

RP508K121x ($V_{IN} = 3.6\text{ V}$, $V_{OUT} = 1.2\text{ V}$)
 L = MDT1608CHR47N (1608size_0.47 μH)
 MODE = "H" forced PWM control

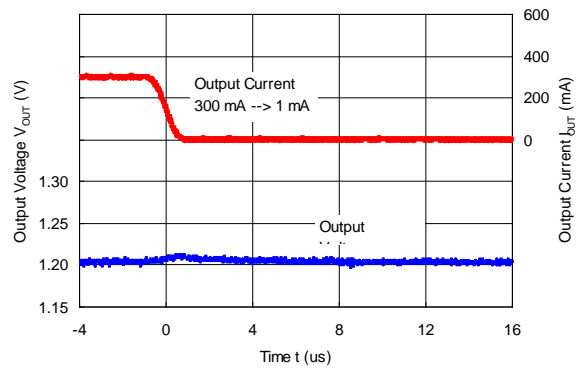

RP508K121x ($V_{IN} = 3.6\text{ V}$, $V_{OUT} = 1.2\text{ V}$)
 L = MDT1608CHR47N (1608size_0.47 μH)
 MODE = "H" forced PWM control

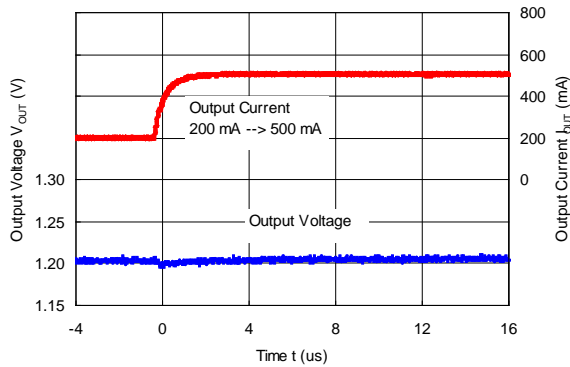

RP508K121x ($V_{IN} = 3.6\text{ V}$, $V_{OUT} = 1.2\text{ V}$)
 L = MDT1608CHR47N (1608size_0.47 μH)
 MODE = "H" forced PWM control

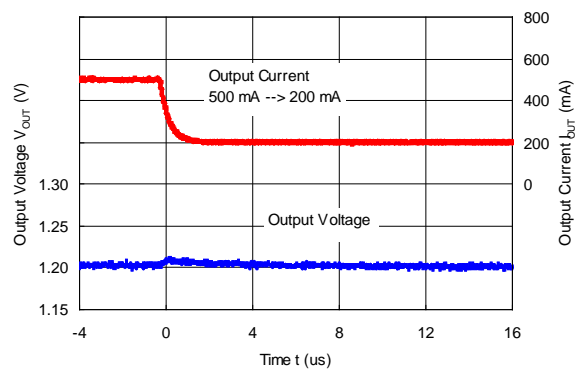

RP508K181x ($V_{IN} = 3.6\text{ V}$, $V_{OUT} = 1.8\text{ V}$)
 L = MDT1608CHR47N (1608size_0.47 μH)
 MODE = "H" forced PWM control

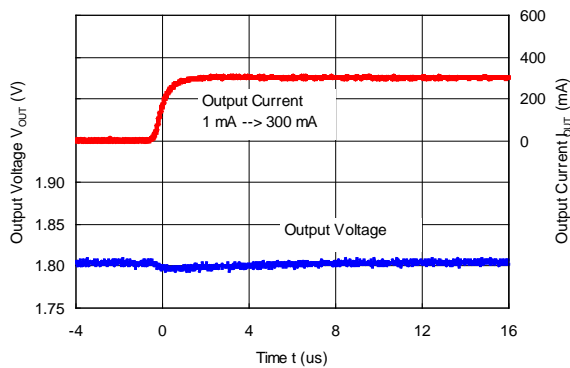

RP508K181x ($V_{IN} = 3.6\text{ V}$, $V_{OUT} = 1.8\text{ V}$)
 L = MDT1608CHR47N (1608size_0.47 μH)
 MODE = "H" forced PWM control

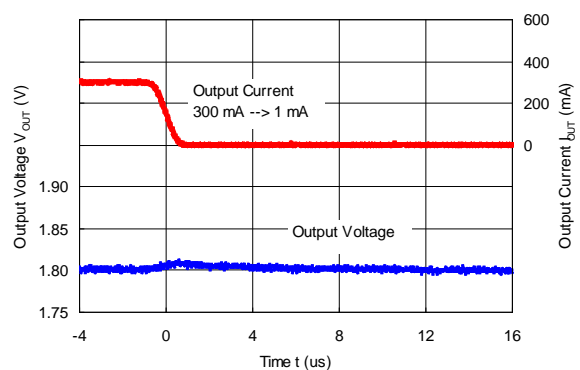

RP508K

NO. EA-318-171106

RP508K181x ($V_{IN} = 3.6\text{ V}$, $V_{OUT} = 1.8\text{ V}$)
L = MDT1608CHR47N (1608size_0.47 μH)
MODE = "H" forced PWM control

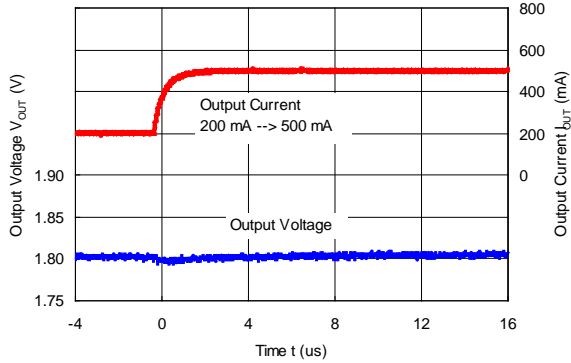

RP508K181x ($V_{IN} = 3.6\text{ V}$, $V_{OUT} = 1.8\text{ V}$)
L = MDT1608CHR47N (1608size_0.47 μH)
MODE = "H" forced PWM control

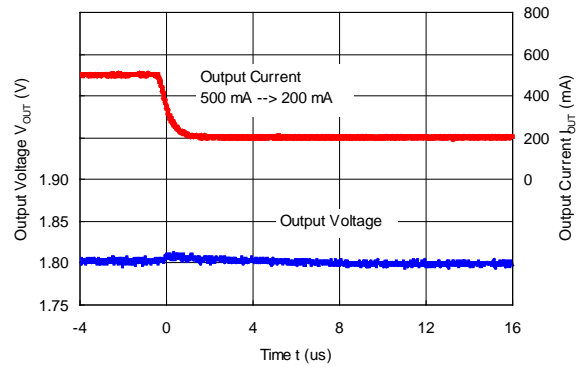

RP508K331x ($V_{IN} = 5.0\text{ V}$, $V_{OUT} = 3.3\text{ V}$)
L = MDT1608CH1R0N (1608size_1.0 μH)
MODE = "H" forced PWM control

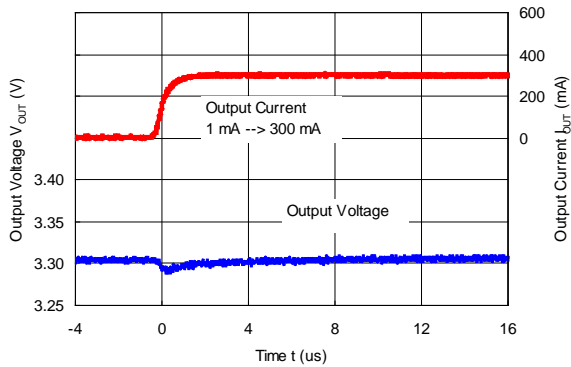

RP508K331x ($V_{IN} = 5.0\text{ V}$, $V_{OUT} = 3.3\text{ V}$)
L = MDT1608CH1R0N (1608size_1.0 μH)
MODE = "H" forced PWM control

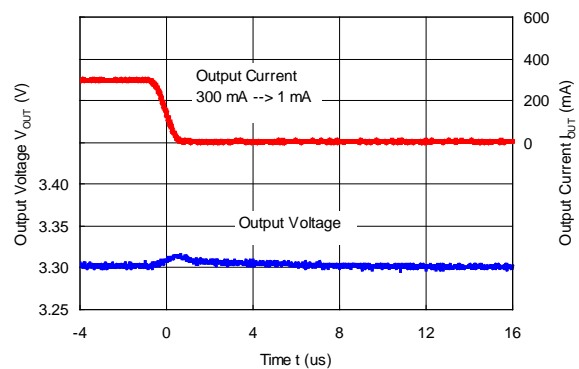

RP508K331x ($V_{IN} = 5.0\text{ V}$, $V_{OUT} = 3.3\text{ V}$)
L = MDT1608CH1R0N (1608size_1.0 μH)
MODE = "H" forced PWM control

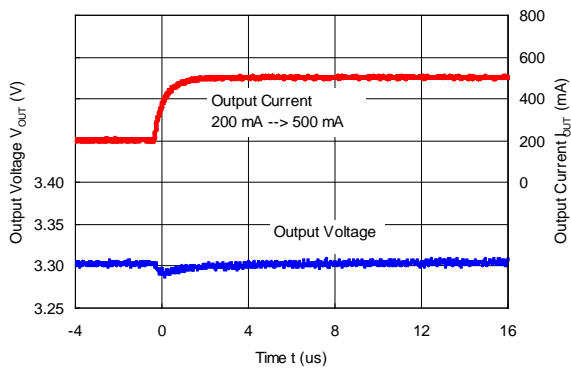

RP508K331x ($V_{IN} = 5.0\text{ V}$, $V_{OUT} = 3.3\text{ V}$)
L = MDT1608CH1R0N (1608size_1.0 μH)
MODE = "H" forced PWM control

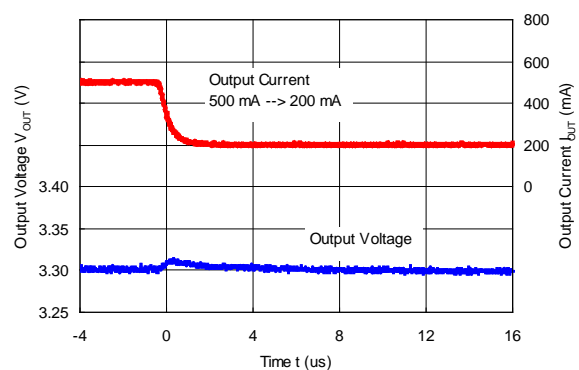

Load Transient Response (C_{OUT} = 4.7μF, C1005X5R0J475M)

RP508K081x (V_{IN} = 3.6 V, V_{OUT} = 0.8 V)
 L = MDT1608CHR47N (1608size_0.47 μH)
 MODE = "L" PWM/VFM auto switching control

RP508K081x (V_{IN} = 3.6V, V_{OUT} = 0.8 V)
 L = MDT1608CHR47N (1608size_0.47 μH)
 MODE = "L" PWM/VFM auto switching control

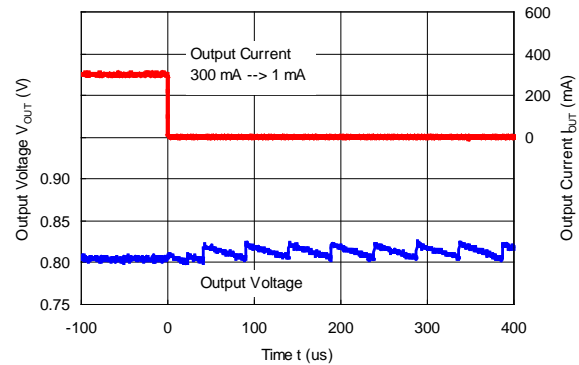
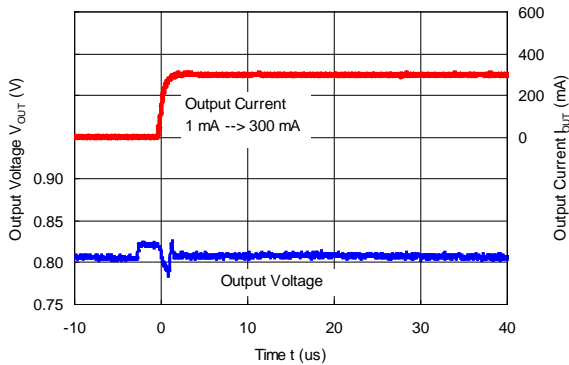

RP508K121x (V_{IN} = 3.6 V, V_{OUT} = 1.2 V)
 L = MDT1608CHR47N (1608size_0.47 μH)
 MODE = "L" PWM/VFM auto switching control

RP508K121x (V_{IN} = 3.6 V, V_{OUT} = 1.2 V)
 L = MDT1608CHR47N (1608size_0.47 μH)
 MODE = "L" PWM/VFM auto switching control

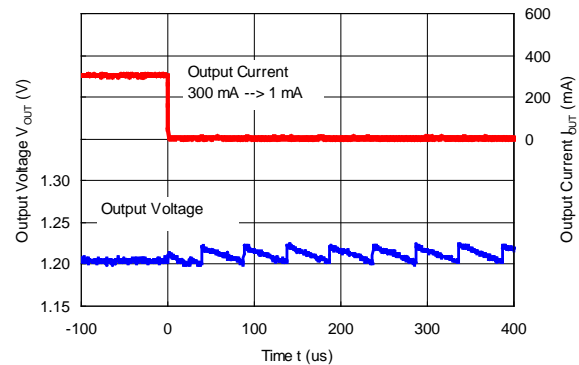
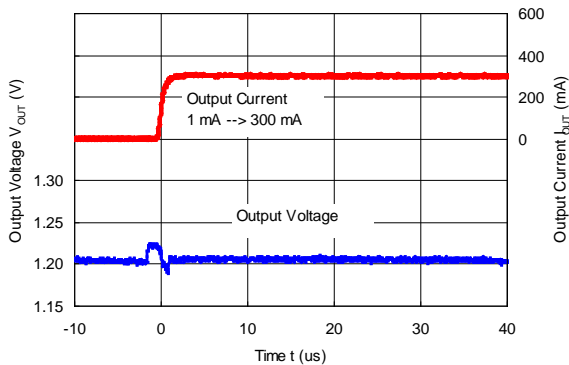

RP508K181x (V_{IN} = 3.6 V, V_{OUT} = 1.8 V)
 L = MDT1608CHR47N (1608size_0.47 μH)
 MODE = "L" PWM/VFM auto switching control

RP508K181x (V_{IN} = 3.6 V, V_{OUT} = 1.8 V)
 L = MDT1608CHR47N (1608size_0.47 μH)
 MODE = "L" PWM/VFM auto switching control

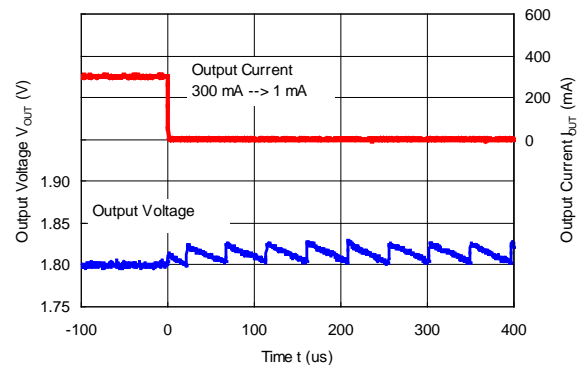
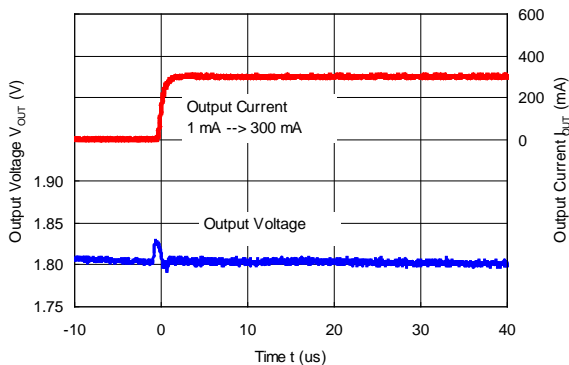

RP508K

NO. EA-318-171106

RP508K331x ($V_{IN} = 5.0\text{ V}$, $V_{OUT} = 3.3\text{ V}$)
 L = MDT1608CH1R0N (1608size_1.0 μH)
 MODE = "L" PWM/VFM auto switching control

RP508K331x ($V_{IN} = 5.0\text{ V}$, $V_{OUT} = 3.3\text{ V}$)
 L = MDT1608CH1R0N (1608size_1.0 μH)
 MODE = "L" PWM/VFM auto switching control

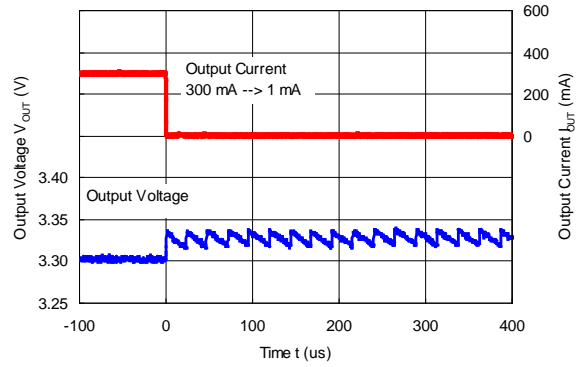
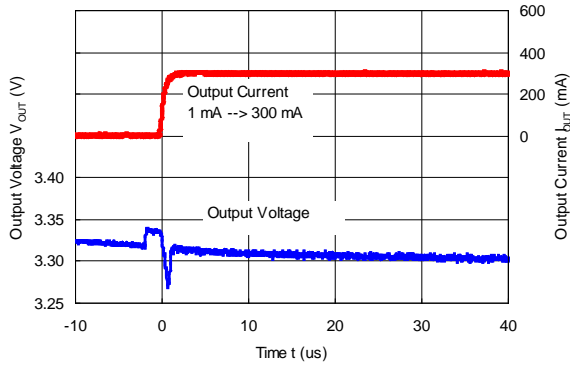

19) Mode Switching Waveform

RP508K121x ($V_{IN} = 3.6\text{ V}$, $V_{OUT} = 1.2\text{ V}$, $I_{OUT} = 1\text{ mA}$)
 MODE = "L" → MODE = "H"

RP508K121x ($V_{IN} = 3.6\text{ V}$, $V_{OUT} = 1.2\text{ V}$, $I_{OUT} = 1\text{ mA}$)
 MODE = "H" → MODE = "L"

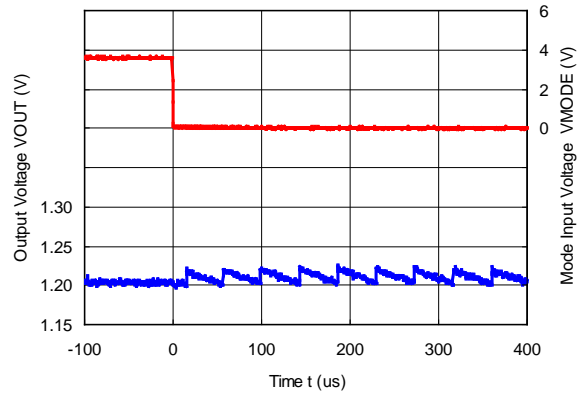
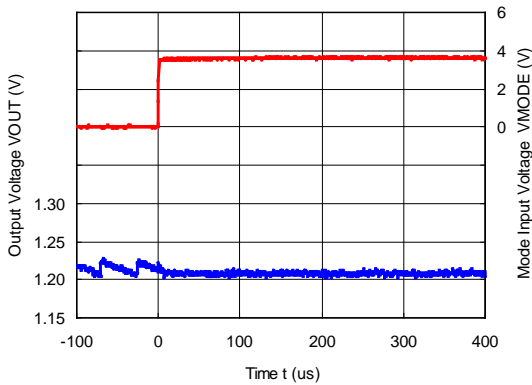

RP508K181x ($V_{IN} = 3.6\text{ V}$, $V_{OUT} = 1.8\text{ V}$, $I_{OUT} = 1\text{ mA}$)
 MODE = "L" → MODE = "H"

RP508K181x ($V_{IN} = 3.6\text{ V}$, $V_{OUT} = 1.8\text{ V}$, $I_{OUT} = 1\text{ mA}$)
 MODE = "H" → MODE = "L"

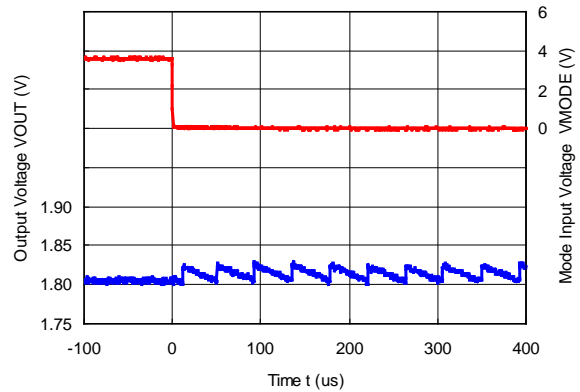
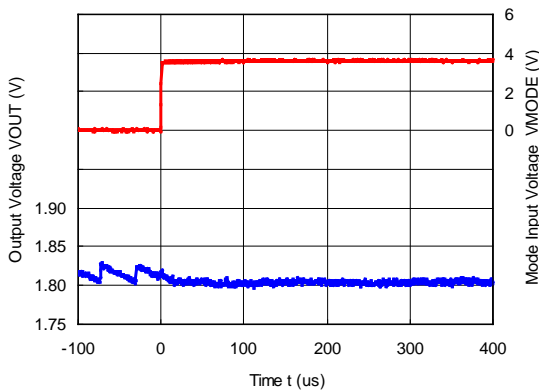

The power dissipation of the package is dependent on PCB material, layout, and environmental conditions. The following conditions are used in this measurement.

Measurement Conditions

JEDEC STD.51-7 Test Land Pattern	
Environment	Mounting on Board (Wind Velocity = 0 m/s)
Board Material	Glass Cloth Epoxy Plastic (Four-Layer Board)
Board Dimensions	76.2 mm × 114.3 mm × 1.6 mm
Copper Ratio	Outer Layers (First and Fourth Layers): Less than 10% of 60 mm Square Inner Layers (Second and Third Layers): 100% of 74.2 mm Square
Through-holes	φ 0.85 mm × 44 pcs

Measurement Result

(Ta = 25°C, Tjmax = 125°C)

JEDEC STD.51-7 Test Land Pattern	
Power Dissipation	666 mW
Thermal Resistance	$\theta_{ja} = (125 - 25^\circ\text{C}) / 0.666 \text{ W} = 150^\circ\text{C/W}$ $\theta_{jc} = 28^\circ\text{C/W}$

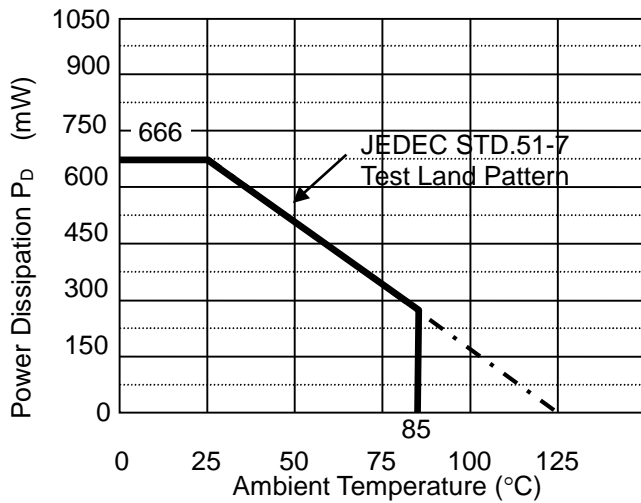

Power Dissipation vs. Ambient Temperature

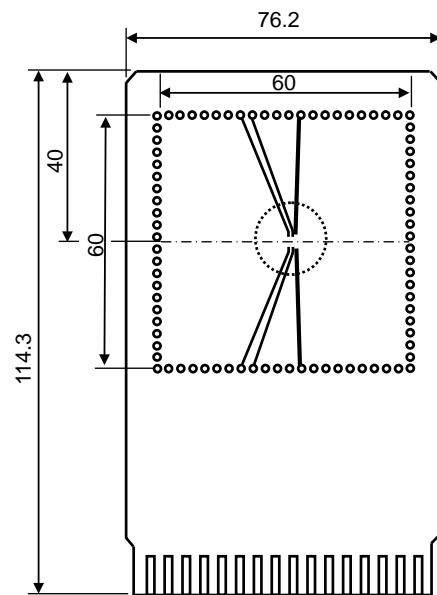

Measurement Board Pattern

○ IC Mount Area (mm)

Measurement Board Pattern

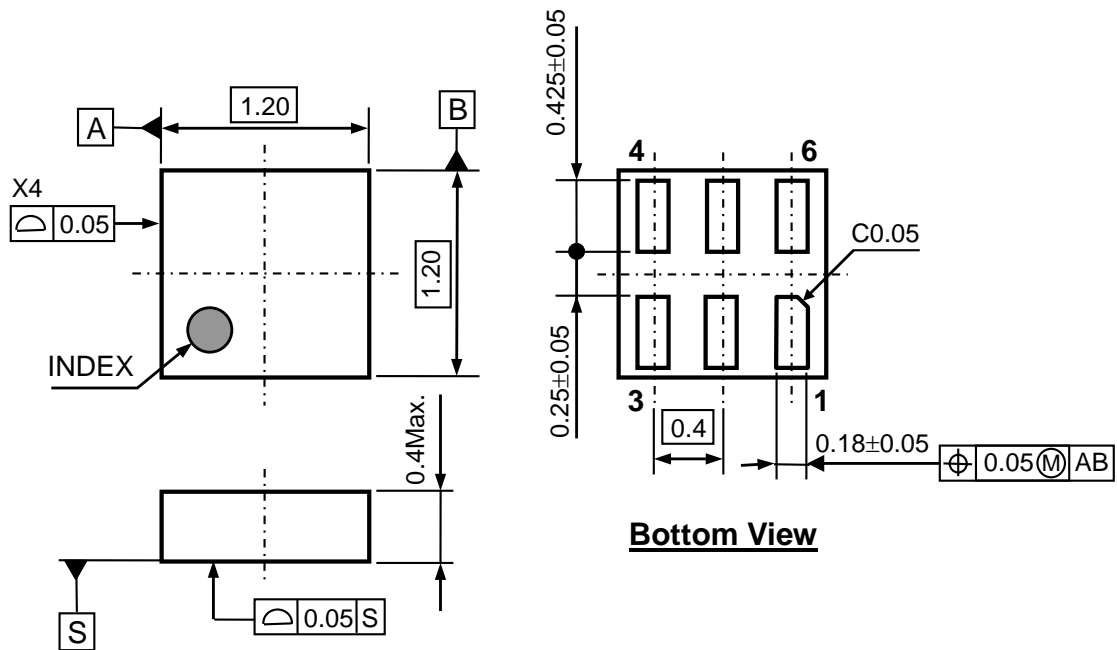

DFN(PLP)1212-6F Package Dimensions (Unit: mm)



1. The products and the product specifications described in this document are subject to change or discontinuation of production without notice for reasons such as improvement. Therefore, before deciding to use the products, please refer to Ricoh sales representatives for the latest information thereon.
2. The materials in this document may not be copied or otherwise reproduced in whole or in part without prior written consent of Ricoh.
3. Please be sure to take any necessary formalities under relevant laws or regulations before exporting or otherwise taking out of your country the products or the technical information described herein.
4. The technical information described in this document shows typical characteristics of and example application circuits for the products. The release of such information is not to be construed as a warranty of or a grant of license under Ricoh's or any third party's intellectual property rights or any other rights.
5. The products listed in this document are intended and designed for use as general electronic components in standard applications (office equipment, telecommunication equipment, measuring instruments, consumer electronic products, amusement equipment etc.). Those customers intending to use a product in an application requiring extreme quality and reliability, for example, in a highly specific application where the failure or misoperation of the product could result in human injury or death (aircraft, spacevehicle, nuclear reactor control system, traffic control system, automotive and transportation equipment, combustion equipment, safety devices, life support system etc.) should first contact us.
6. We are making our continuous effort to improve the quality and reliability of our products, but semiconductor products are likely to fail with certain probability. In order to prevent any injury to persons or damages to property resulting from such failure, customers should be careful enough to incorporate safety measures in their design, such as redundancy feature, fire containment feature and fail-safe feature. We do not assume any liability or responsibility for any loss or damage arising from misuse or inappropriate use of the products.
7. Anti-radiation design is not implemented in the products described in this document.
8. The X-ray exposure can influence functions and characteristics of the products. Confirm the product functions and characteristics in the evaluation stage.
9. WLCSP products should be used in light shielded environments. The light exposure can influence functions and characteristics of the products under operation or storage.
10. There can be variation in the marking when different AOI (Automated Optical Inspection) equipment is used. In the case of recognizing the marking characteristic with AOI, please contact Ricoh sales or our distributor before attempting to use AOI.
11. Please contact Ricoh sales representatives should you have any questions or comments concerning the products or the technical information.



Ricoh is committed to reducing the environmental loading materials in electrical devices with a view to contributing to the protection of human health and the environment.

Ricoh has been providing RoHS compliant products since April 1, 2006 and Halogen-free products since April 1, 2012.

RICOH RICOH ELECTRONIC DEVICES CO., LTD.

<https://www.e-devices.ricoh.co.jp/en/>

Sales & Support Offices

Ricoh Electronic Devices Co., Ltd.

Shin-Yokohama Office (International Sales)

2-3, Shin-Yokohama 3-chome, Kohoku-ku, Yokohama-shi, Kanagawa, 222-8530, Japan
Phone: +81-50-3814-7687 Fax: +81-45-474-0074

Ricoh Americas Holdings, Inc.

675 Campbell Technology Parkway, Suite 200 Campbell, CA 95008, U.S.A.
Phone: +1-408-610-3105

Ricoh Europe (Netherlands) B.V.

Semiconductor Support Centre

Prof. W.H. Keesomlaan 1, 1183 DJ Amstelveen, The Netherlands
Phone: +31-20-5474-309

Ricoh International B.V. - German Branch

Semiconductor Sales and Support Centre

Oberrather Strasse 6, 40472 Düsseldorf, Germany
Phone: +49-211-6546-0

Ricoh Electronic Devices Korea Co., Ltd.

3F, Haesung Bldg, 504, Teheran-ro, Gangnam-gu, Seoul, 135-725, Korea
Phone: +82-2-2135-5700 Fax: +82-2-2051-5713

Ricoh Electronic Devices Shanghai Co., Ltd.

Room 403, No.2 Building, No.690 Bibo Road, Pu Dong New District, Shanghai 201203,
People's Republic of China
Phone: +86-21-5027-3200 Fax: +86-21-5027-3299

Ricoh Electronic Devices Shanghai Co., Ltd.

Shenzhen Branch

1205, Block D (Jinlong Building), Kingkey 100, Hongbao Road, Luohu District,
Shenzhen, China
Phone: +86-755-8348-7600 Ext 225

Ricoh Electronic Devices Co., Ltd.

Taipei office

Room 109, 10F-1, No.51, Hengyang Rd., Taipei City, Taiwan (R.O.C.)
Phone: +886-2-2313-1621/1622 Fax: +886-2-2313-1623

X-ON Electronics

Largest Supplier of Electrical and Electronic Components

Click to view similar products for [LDO Voltage Regulators](#) category:

Click to view products by [Nisshinbo](#) manufacturer:

Other Similar products are found below :

[AP7363-SP-13](#) [L79M05TL-E](#) [PT7M8202B12TA5EX](#) [TCR3DF185,LM\(CT](#) [TCR3DF24,LM\(CT](#) [TCR3DF285,LM\(CT](#) [TCR3DF31,LM\(CT](#)
[TCR3DF45,LM\(CT](#) [MP2013GQ-33-Z](#) [059985X](#) [NCP4687DH15T1G](#) [701326R](#) [TCR2EN28,LF\(S](#) [NCV8170AXV250T2G](#)
[TCR3DF27,LM\(CT](#) [TCR3DF19,LM\(CT](#) [TCR3DF125,LM\(CT](#) [TCR2EN18,LF\(S](#) [AP2112R5A-3.3TRG1](#) [AP7315-25W5-7](#)
[IFX30081LDVGRNXUMA1](#) [NCV47411PAAJR2G](#) [AP2113KTR-G1](#) [AP2111H-1.2TRG1](#) [ZLDO1117QK50TC](#) [AZ1117IH-1.8TRG1](#)
[AZ1117ID-ADJTRG1](#) [TCR3DG12,LF](#) [MIC5514-3.3YMT-T5](#) [MIC5512-1.2YMT-T5](#) [MIC5317-2.8YM5-T5](#) [SCD7912BTG](#)
[NCP154MX180270TAG](#) [SCD33269T-5.0G](#) [NCV8170BMX330TCG](#) [NCV8170AMX120TCG](#) [NCP706ABMX300TAG](#)
[NCP153MX330180TCG](#) [NCP114BMX075TCG](#) [MC33269T-3.5G](#) [CAT6243-ADJCMT5T](#) [TCR3DG33,LF](#) [AP2127N-1.0TRG1](#)
[TCR4DG35,LF](#) [TAR5S15U\(TE85L,F\)](#) [TAR5S18U\(TE85L,F\)](#) [TCR3UG19A,LF](#) [TCR4DG105,LF](#) [NCV8170AMX360TCG](#) [MIC94310-](#)
[NYMT-T5](#)