

General Specifications

Electrical Capacity (Resistive Load)

Low Level: 100mA maximum @ 12V DC

Other Ratings

Contact Resistance:	200 milliohms maximum
Insulation Resistance:	100 megohms minimum @ 250V DC
Dielectric Strength:	1,000V AC minimum between contacts for 1 minute minimum 1,500V AC minimum between contacts & case for 1 minute minimum
Mechanical Life:	5,000,000 operations minimum
Electrical Life:	5,000,000 operations minimum
Nominal Operating Force:	1.6N maximum (at center of cap)
Travel:	Pretravel .091" (2.3mm); Overtravel .047" (1.2mm); Total Travel .138" (3.5mm)

Materials & Finishes

Plunger/Upper Housing:	Polycetal	Lower Housing:	Glass fiber reinforced PBT (UL94V-0)
Movable Contact:	Stainless steel with gold plating	Stationary Contacts:	Gold over copper alloy
Switch Terminals:	Brass with tin plating		

Environmental Data

Operating Temperature Range:	-25°C through +50°C (-13°F through +122°F)
Humidity:	90 – 95% humidity for 240 hours @ 40°C (104°F)
Vibration:	10 ~ 55Hz with peak-to-peak amplitude of 1.5mm traversing the frequency range & returning in 1 minute; 3 right angled directions for 2 hours
Shock:	51G (500m/s ²) acceleration (tested in 6 right angled directions, with 5 shocks in each direction)

Installation

Cap Installation Force: 50.0N maximum downward force on actuator

PCB Processing

Soldering:	Wave Soldering. Preheat temperature: 110°C @ 40 seconds; Peak temperature: 270°C @ 6 seconds; Cycles: 2 Manual Soldering. 390°C @ 4 seconds; Cycles: 2
Cleaning:	These devices are not process sealed. Hand clean locally using alcohol based solution.

Standards & Certifications

Flammability Standards: UL94V-0 lower housing

The KP Series pushbuttons have not been tested for UL recognition or CSA certification. These switches are designed for use in a low-voltage, low-current, logic-level circuit. When used as intended in a logic-level circuit, the results do not produce hazardous energy.

Distinctive Characteristics

KP Series' latest offering in single color super bright white, yellow or blue LEDs with 2-pin termination.

Ideal solution for a variety of control panel compositions.

Shorter stroke of .138" (3.5mm).

Nontactile actuation underlined with smooth, silent operation.

Compact design with height of .906" (23.0mm) from PC board to top of cap (same height as programmable SmartSwitch®).

Flat, sculptured or home key square caps in two common sizes for design flexibility in various applications.

Twin contacts with gold plating assure high reliability and long life of 5,000,000 operations minimum.

Custom legends available.

Actual Size

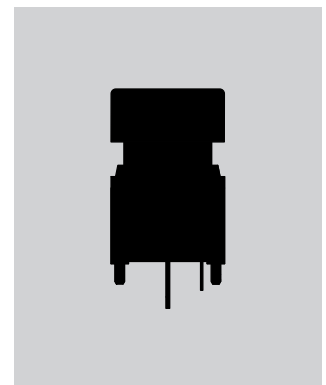

TYPICAL SWITCH ORDERING EXAMPLE

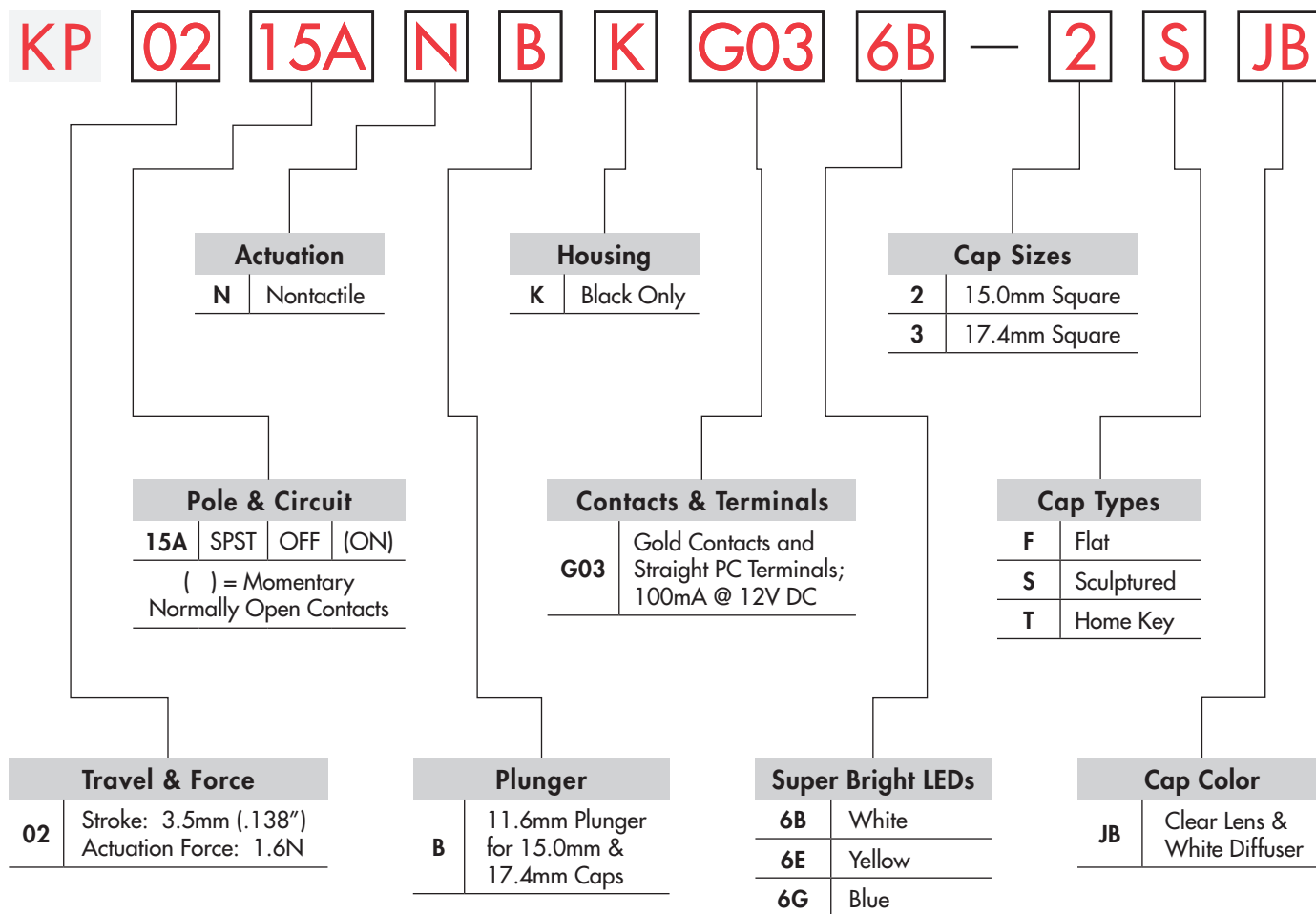

DESCRIPTION FOR TYPICAL ORDERING EXAMPLE

KP0215ANBKG036B-2SJB



POLE & CIRCUIT

		Plunger Position () = Momentary		Connected Terminals		Throw & Switch Schematic
Pole	Model	Normal	Down	Normal	Down	Note: Switch terminals "1" & "1a" are actually marked on the switch.
SP	KP0215A	OFF	(ON)	Normally Open	1-1a	SPST 

ACTUATION

N Nontactile

B 11.6mm Plunger for 15.0mm & 17.4mm Caps

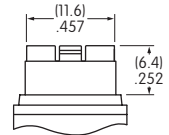

11.6mm Plunger has a wide neck, easily holding either the 15.0mm or the 17.4mm Caps.

HOUSING

K Black Only

G03 Gold Contacts
100mA @ 12V DC
Straight PC Terminals

CONTACTS, TERMINALS, & RATING

CAP TYPES & COLORS

2 15.0mm Square

F AT3084 Flat Cap

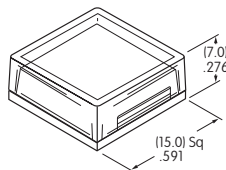

S AT3079 Sculptured Cap

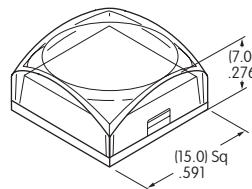

T AT3087 Home Key Cap

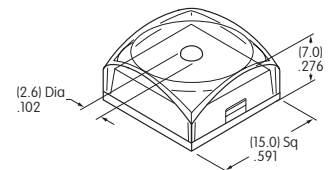

3 17.4mm Square

F AT3085 Flat Cap

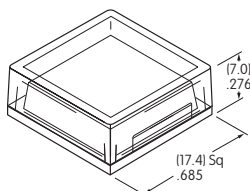

S AT3080 Sculptured Cap

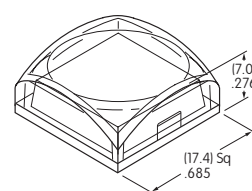

T AT3088 Home Key Cap

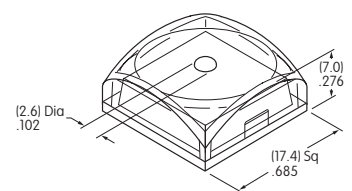

JB Lens & Diffuser Colors Available:

Clear/White

Materials & Finishes: Lens - Polycarbonate with glossy finish

Diffuser - Polycarbonate with textured finish

Optional Protective Guard AT4170 available; contact factory.

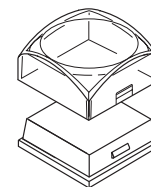

Clear Lens

White Diffuser

SUPER BRIGHT LED SPECIFICATIONS

The electrical specifications shown are determined at a basic temperature of 25°C. LEDs are an integral part of the switch and not available separately. LED circuit is isolated and requires an external power source.

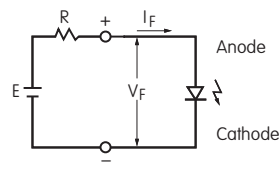
		6B	6E	6G	If the source voltage exceeds the rated voltage, a ballast resistor is required. The resistor value can be calculated by using the formula shown here.
		White	Yellow	Blue	
Maximum Forward Current	I_{FM}	30mA	30mA	30mA	 $R = \frac{E - V_F}{I_F}$ <p>Where: R = Resistor Value (Ohms) E = Source Voltage (V) V_F = Forward Voltage (V) I_F = Forward Current (A)</p>
Typical Forward Current	I_F	20mA	20mA	20mA	
Forward Voltage	V_F	3.2V	3.2V	3.2V	
Maximum Reverse Voltage	V_{RM}	5V	5V	5V	
Current Reduction Rate Above 30°C	ΔI_F	0.45mA/°C	.045mA/°C	.045mA/°C	
Ambient Temperature Range		-25 ~ +50°C	-25 ~ +50°C	-25 ~ +50°C	

TYPICAL SWITCH DIMENSIONS

15.0mm Square Cap with Yellow LED

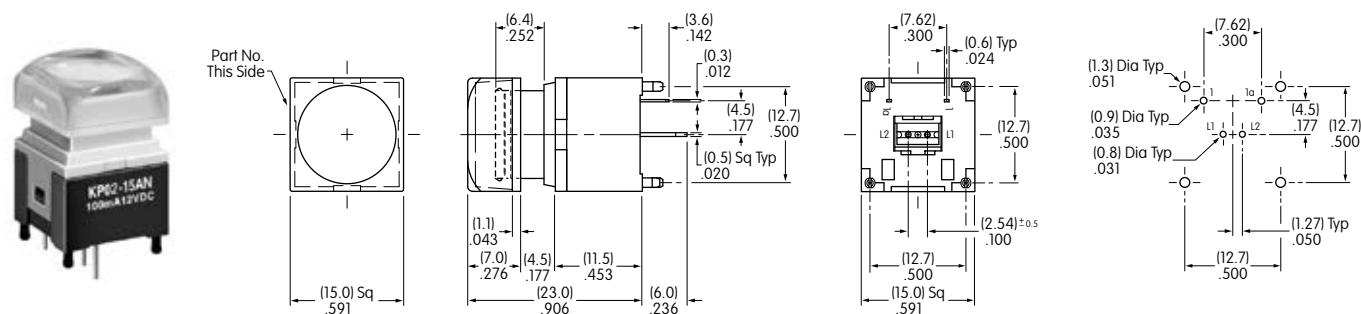

KP0215ANBKG036E-2SJB

17.4mm Square Cap with Blue LED

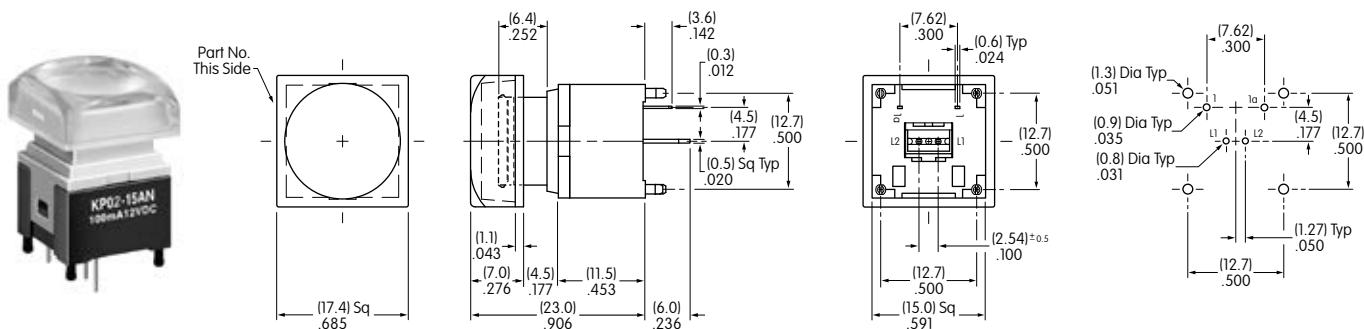

KP0215ANBKG036G-3SJB

ASSEMBLY INSTRUCTIONS FOR SQUARE CAPS



Cap Orientation

As shown in the accompanying illustration, the cap and plunger are designed with tabs and notches to assure proper orientation of the cap on the switch.

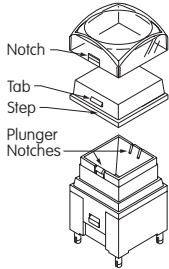

Removal of Cap Assembly & Separation of Lens & Diffuser

Holding the switch tightly, pull the cap off the switch. Once the cap assembly is released from the plunger, the lens and diffuser can be separated. Pry up the lens with fingernail or flat tip screwdriver inserted at the step on the diffuser.

Installation or Replacement of Cap

After aligning notches with tabs, join the lens and diffuser. Hold the switch tightly without touching the terminals. Firmly press the cap onto the plunger by applying pressure from one side to the other until both are snapped together.

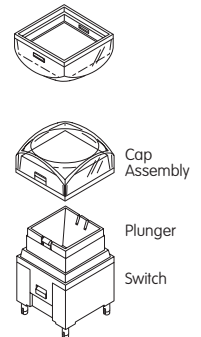

LEGENDS

NKK Switches can provide custom legends for caps. Contact factory for more information.

Suggested Printable Areas for KP Lens

Recommended Methods:

- Laser Etch on clear lens, Screen Print, or Pad Print on lens.
- Laser Print on film insert.
- Epoxy based ink is recommended.

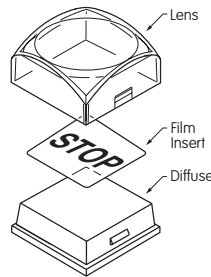

Printing on Diffuser is not advisable.

Shaded areas are suggested printable areas for Lens.

Flat Cap Lens

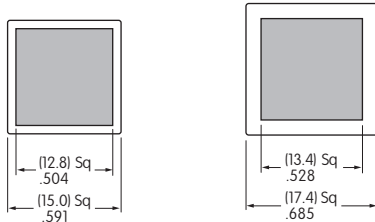

Sculptured Cap Lens

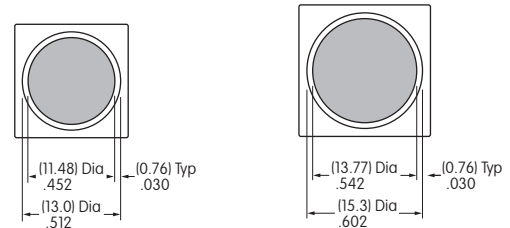

Suggested Printable Areas for KP Film Insert

Shaded areas are suggested printable areas for Film Insert.

Flat Cap Film Inserts

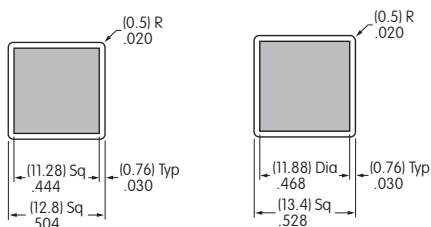

Sculptured Cap Film Inserts

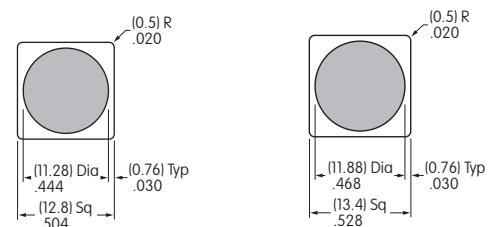

Film Insert Material and Thickness: Clear Polyester; 4 mil (100µ) maximum thickness

X-ON Electronics

Largest Supplier of Electrical and Electronic Components

Click to view similar products for [Pushbutton Switches](#) category:

Click to view products by [NKK Switches](#) manufacturer:

Other Similar products are found below :

[LW1L-M1C10V-A](#) [LW2L-A1C20M-GD](#) [LW2L-M1C20M-A](#) [60324L](#) [M7E-HRN2](#) [67021K512](#) [67081K512X](#) [701PB580](#) [719-5504-000](#)
[MDPSSGLFS](#) [810KSV30B](#) [FLT 2U EE 01A](#) [MML21KA3ABK](#) [MML23KA3AC05K-001](#) [MML23KW3AA01W](#) [8418K2](#) [8646AB6X718UL](#)
[8646ABUL](#) [FSDWH](#) [9001KXRK](#) [9001T8BK](#) [9533CD4+U574+U4922](#) [1203MRA](#) [A22EM01S](#) [A595](#) [1202A6](#) [12037A2ULCSA](#) [1203A2UL](#)
[ABD122N-B](#) [1211390004](#) [ABN111-Y](#) [ABN400-R](#) [1211500044](#) [1211580012](#) [1212MRA](#) [1232A6NF](#) [RA3CSH6A](#) [1241.1183.7047](#)
[1241.2511](#) [1241.3428](#) [1223A2ULCSA](#) [1223MRA](#) [1232AX2119](#) [1241.1183.8000](#) [1241.1183.8029](#) [1241.2506](#) [1241.2606](#) [12MA6](#)
[1301940184](#) [RELBARF6X10\(PLASTIC\)](#)