

General Specifications

Toggles

Rockers
B

Pushbuttons

Illuminated PB

Programmable

Keylocks

Rotaries

Slides

Tactiles

Tilt

Touch

Indicators

Accessories

Supplement

Electrical Capacity (Resistive Load)

Logic Level: 0.4VA maximum @ 28V AC/DC maximum
(Applicable Range 0.1mA ~ 0.1A @ 20mV ~ 28V)
Note: Find additional explanation of operating range in Supplement section.

Other Ratings

Contact Resistance: 50 milliohms maximum
Insulation Resistance: 500 megohms minimum @ 500V DC
Dielectric Strength: 500V AC minimum for 1 minute minimum
Mechanical Life: 100,000 operations minimum for On-None-On & On-Off-On
 50,000 operations minimum for other circuits
Electrical Life: 50,000 operations minimum
Nominal Operating Force: 2.73N (momentary); 1.84N (maintained)
Contact Timing: Nonshorting (break-before-make)
Angle of Throw: 26°

Materials & Finishes

Actuator or Toggle: Nickel plated brass
Case Housing: Glass fiber reinforced polyamide
Support Bracket: Tin plated phosphor bronze
Movable Contact: Phosphor bronze with gold plating
Stationary Contacts: Brass with gold plating
Terminals: Brass with gold plating

Environmental Data

Operating Temperature Range: -30°C through +85°C (-22°F through +185°F)
Humidity: 90 ~ 95% humidity for 240 hours @ 40°C (104°F)
Vibration: 10 ~ 55Hz with peak-to-peak amplitude of 1.5mm traversing the frequency range & returning in 1 minute; 3 right angled directions for 2 hours
Shock: 50G (490m/s²) acceleration (tested in 6 right angled directions, with 5 shocks in each direction)

Installation

Cap Installation Force: 39.23N (8.82 lbf) maximum downward force on actuator

PCB Processing

Soldering: Wave Soldering Recommended: See Profile A in Supplement section.
 Manual Soldering: See Profile B in Supplement section.
Cleaning: Automated cleaning. See Cleaning specifications in Supplement section.

Standards & Certifications

The A Series rockers have not been tested for UL recognition or CSA certification. These switches are designed for use in a low-voltage, low-current, logic-level circuit. When used as intended in a logic-level circuit, the results do not produce hazardous energy.

Distinctive Characteristics

Subminiature size saves space on PC boards.

Specifically developed for logic-level applications.

Totally sealed body construction prevents contact contamination and allows time- and money-saving automated soldering and cleaning.

Award-winning STC contact mechanism with benefits unavailable in conventional mechanisms: smoother, positive detent actuation, increased contact stability and unparalleled logic-level reliability. (Additional STC details in Terms & Acronyms; see Supplement section.)

Molded-in, epoxy sealed or ultrasonically welded terminals lock out flux, solvents, and other contaminants.

.100" x .100" (2.54mm x 2.54mm) terminal spacing conforms to standard PC board grid spacing.

Matching indicators available.

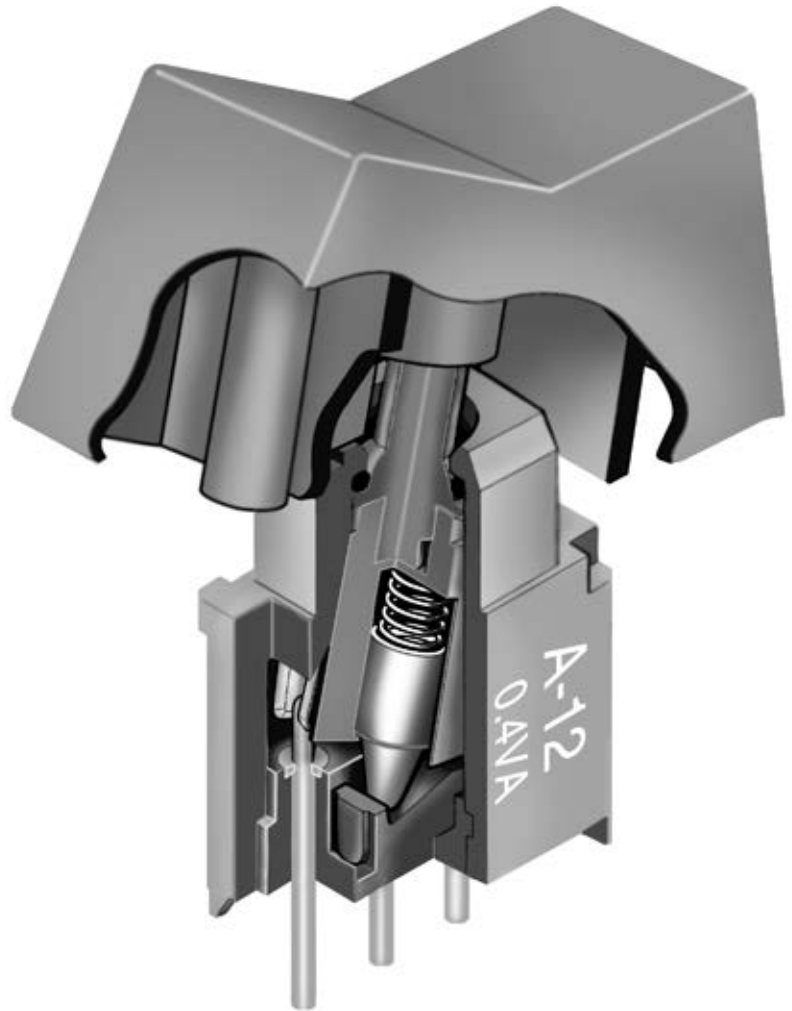

Actual Size

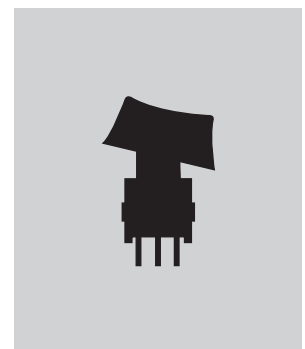

- Supplement
- Accessories
- Indicators
- Touch
- Tilt
- Tactiles
- Slides
- Rotaries
- Keylocks
- Programmable
- Illuminated PB
- Pushbuttons
- B** Rockers
- Toggles

TYPICAL SWITCH ORDERING EXAMPLE

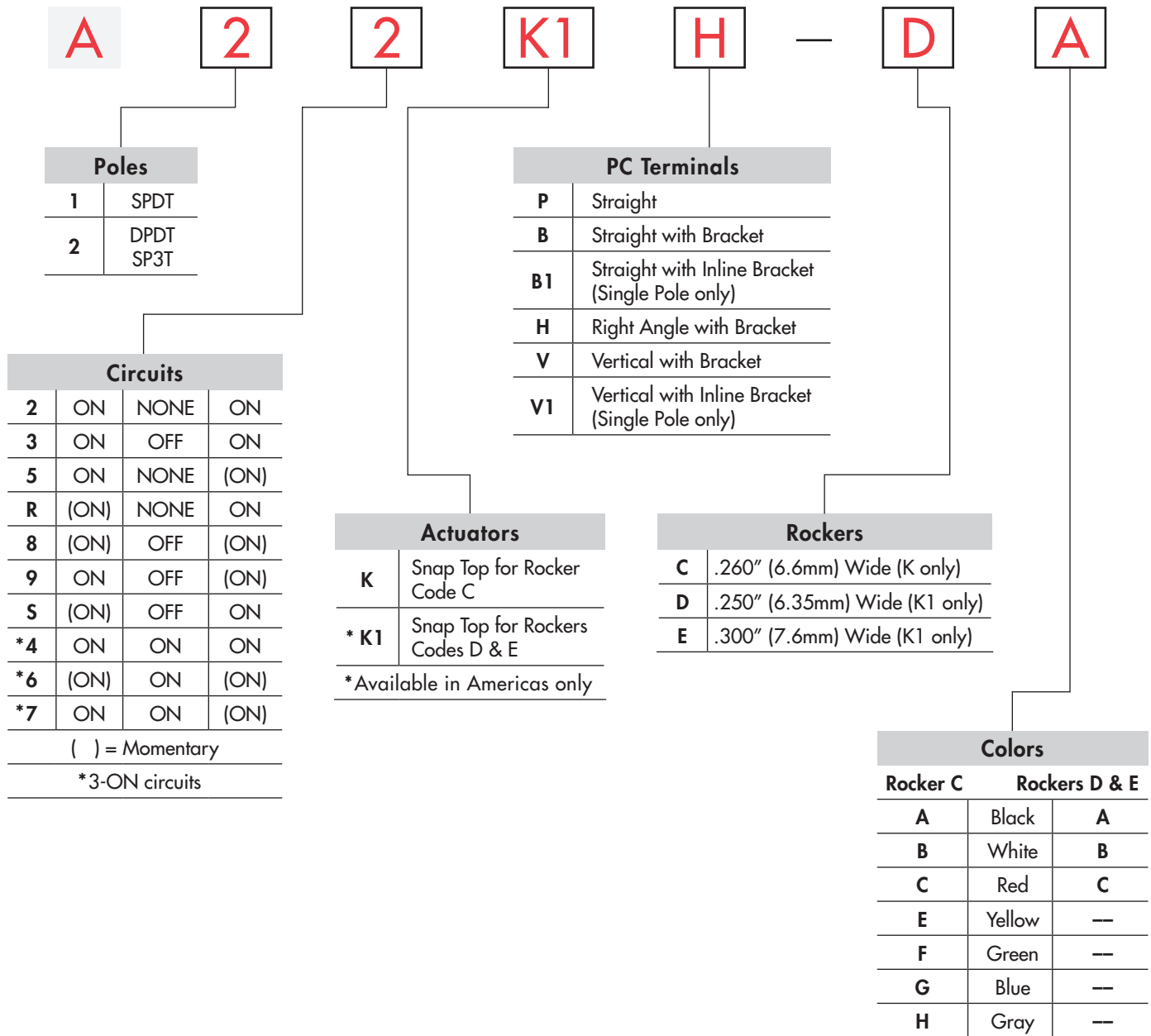

DESCRIPTION FOR TYPICAL ORDERING EXAMPLE

A22K1H-DA

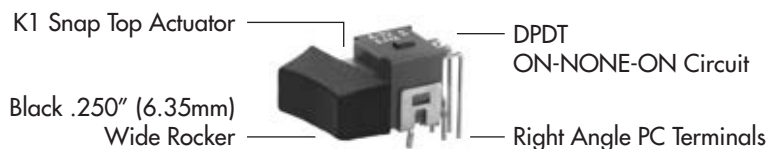

Toggles
Rockers
Pushbuttons
Illuminated PB
Programmable
Keylocks
Rotaries
Slides
Tactiles
Tilt
Touch
Indicators
Accessories
Supplement

POLES & CIRCUITS

Pole	Model	Rocker Position () = Momentary			Connected Terminals			Throw & Schematics
		Up	Center	Down	Up	Center	Down	
								Note: Terminal numbers are not actually on the switch.
SP	A12 A13 A15 A1R A18 A19 A1S	ON ON ON (ON) (ON) ON (ON)	NONE NONE NONE NONE OFF OFF OFF	ON ON (ON) ON (ON) (ON) ON	2-3	OPEN	2-1	SPDT
DP	A22 A23 A25 A2R A28 A29 A2S	ON ON ON (ON) (ON) ON (ON)	NONE OFF NONE NONE OFF OFF OFF	ON ON (ON) ON (ON) (ON) ON	2-3 5-6	OPEN	2-1 5-4	DPDT

For 3 Throw (3-On)

Connected Terminals & Schematics					External Connection
Pole	Model	Up	Center	Down	
SP	A24 A26 A27	ON (ON) ON 2-3 5-6	ON ON ON 2-3 5-4	ON (ON) (ON) 2-1 5-4	The SP3T model utilizes a double pole base. External connections must be made during field installation.

ACTUATORS

K Snap Top

For Rocker AT469

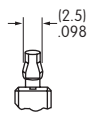
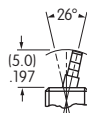

K1 Snap Top

For Rockers AT062 and AT066

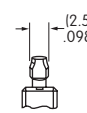
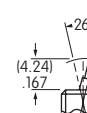

Toggles
Rockers
Pushbuttons
Illuminated PB
Programmable
Keylocks
Rotaries
Slides
Tactiles
Tilt
Touch
Indicators
Accessories
Supplement

PC TERMINALS

Use of a support bracket is recommended to increase PCB mounting strength and stability.

P Straight

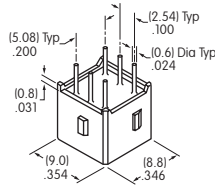

B Straight with Bracket

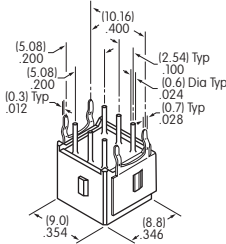

B1 Straight with Inline Bracket Single Pole only

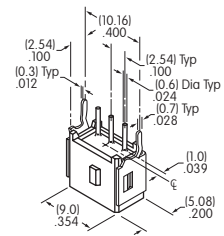

H Right Angle with Bracket

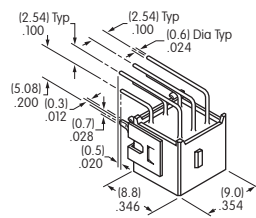

V Vertical with Bracket

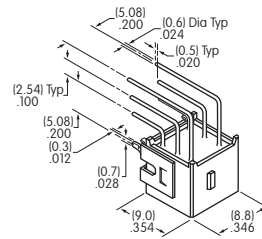

V1 Vertical with Inline Bracket Single Pole only

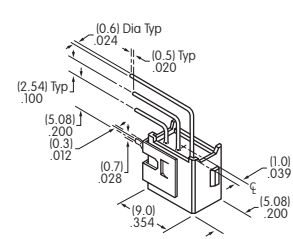

ROCKERS & COLORS

C AT469
.260" (6.6mm) Wide Rocker

Antirotational
Material: Polyamide
Colors Available:
A, B, C, E, F, G, H

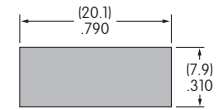
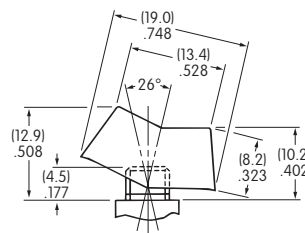

D AT062
.250" (6.35mm) Wide Rocker

Antirotational
Material: Polyamide
Colors Available:
A, B, C

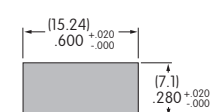
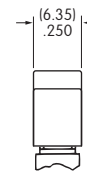
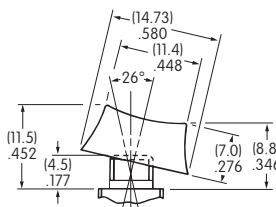

E AT066
.300" (7.6mm) Wide Rocker

Antirotational
Material: Polyamide
Colors Available:
A, B, C

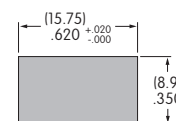
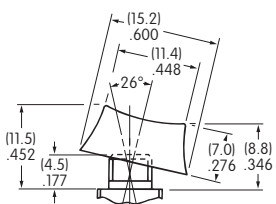

Color Codes:

A Black

B White

C Red

E Yellow

F Green

G Blue

H Gray

TYPICAL SWITCH DIMENSIONS

Single Pole

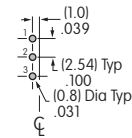
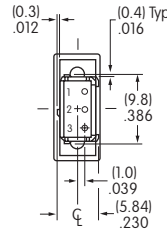
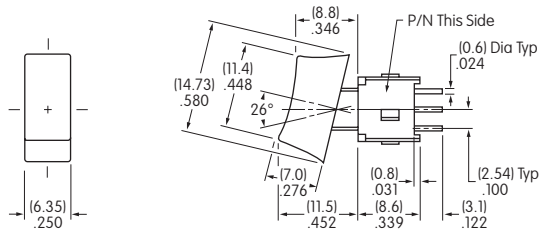

Straight PC



A12K1P-DA

Double Pole

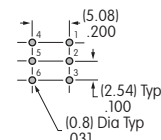
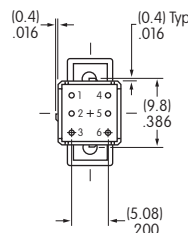
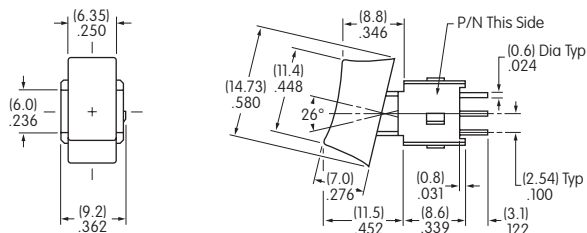

Straight PC



A22K1P-DA

Single Pole

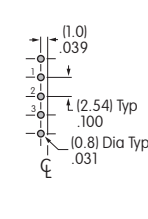
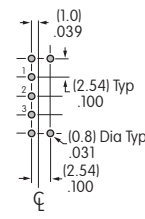
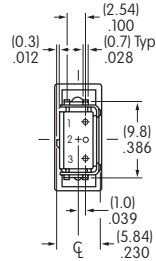
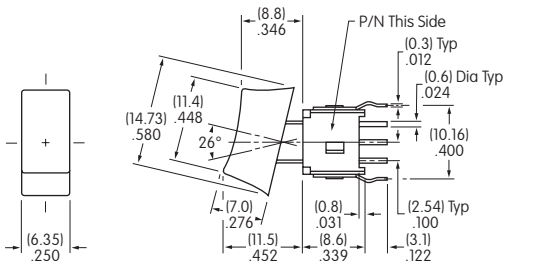

Straight PC • Bracket



A12K1B-DA

Double Pole

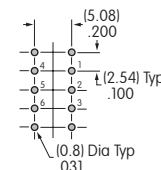
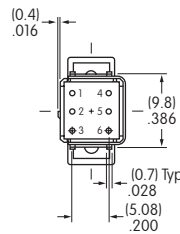
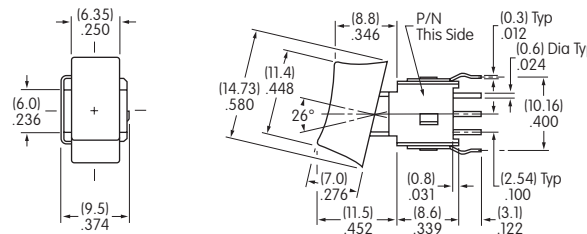

Straight PC • Bracket



A22K1B-DA

Single Pole

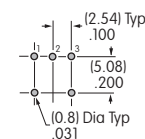
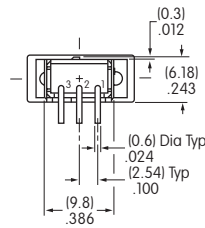
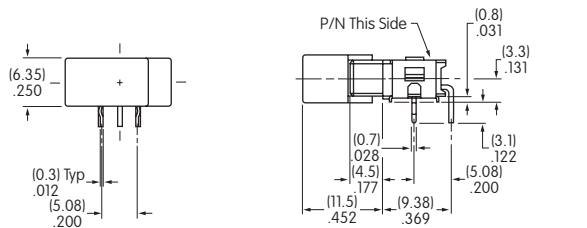

Right Angle PC



A12K1H-DA

TYPICAL SWITCH DIMENSIONS

Right Angle PC

Double Pole

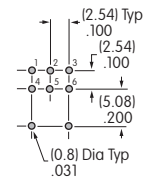
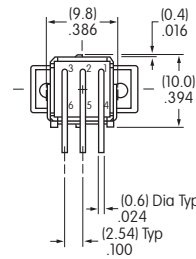
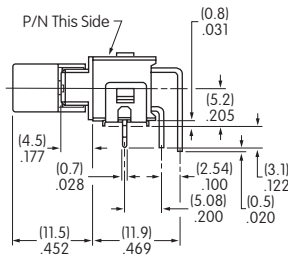
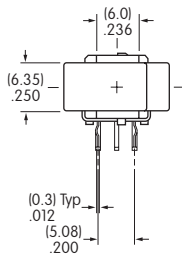

A22K1H-DA

Vertical PC

Single Pole

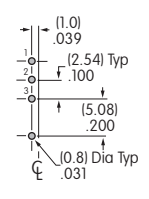
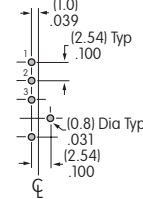
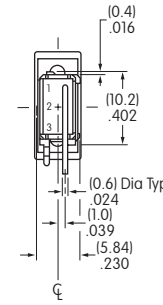
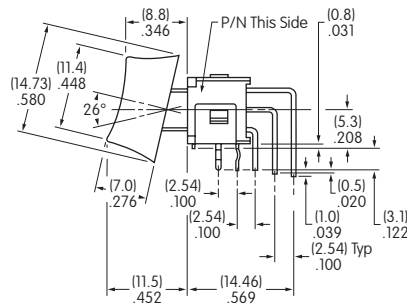
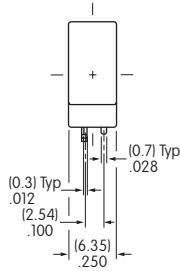

A12K1V-DA

V Terminals

V1 Terminals

Vertical PC

Double Pole

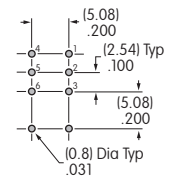
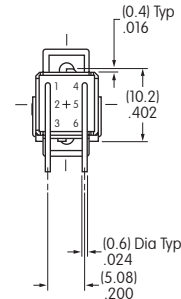
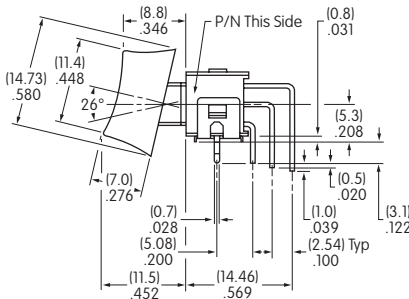
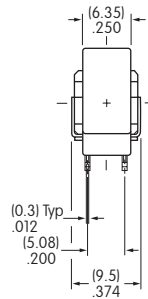

A22K1V-DA

ROCKER MOUNTING PRECAUTION

Rocker switches with vertical and right angle terminals must be mounted so that extension of the PC board beyond the top of the switch housing does not interrupt rocker movement, in turn causing incomplete switching operation.

The MAXIMUM limit of the PC board extension is .051" (1.3mm), as illustrated below.

This precaution does not apply to the double pole switch with right angle terminals due to the extra width of the switch allowing the rocker to clear the PC board.

Side View of Rocker Right Angle Mounting PC Single Pole Only

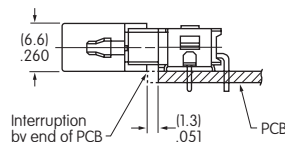

Side View of Rocker Vertical Mounting PC Single Pole and Double Pole

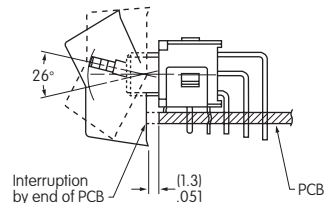

X-ON Electronics

Largest Supplier of Electrical and Electronic Components

Click to view similar products for [Rocker Switches](#) category:

Click to view products by [NKK Switches](#) manufacturer:

Other Similar products are found below :

[LTILA6E-1S-WH-RC-FN12VXCR1](#) [6-1571986-9](#) [8007K26N324V52](#) [8055K23Z7V](#) [8055K32Z7V](#) [8055K52Z7V](#) [8138K20E6M50](#) [84206L](#)
[84312LX](#) [PREDD5-07F-BB0GW](#) [999-16716-002](#) [999-16716-003](#) [999-16716-004](#) [A101J1V3Q004](#) [A101J2ZQ004](#) [A101J4ZQ004](#)
[A101J51CB0004](#) [A103J1ZQ004](#) [A201J1AQ004](#) [A201J3ZB004](#) [A201J50ZQ004](#) [A203J51ZQ0004](#) [A435S1YZQ](#) [H8500XBBBBL-A](#)
[H8653VBBG2577W](#) [HB130CHNWWNAAC](#) [R13112ABB-602W](#) [1251.0303](#) [AE205J60V3B004](#) [1352.0107](#) [1500G51E](#) [1571099-3](#)
[1571987-4](#) [1571987-5](#) [1571989-7](#) [1571988-5](#) [B123J77V7B2](#) [B226J50W4Q22P](#) [B433J37ZQ22M](#) [160212E](#) [1634200-7](#) [1801.1164](#) [1839.1502](#)
[PANEL-PLUG-VHP-BLACK](#) [PANEL-PLUG-VHP-WT](#) [K1ABBSCADN](#) [K2ABAAAAAA](#) [KG312A2DXD246X](#) [250011E714](#) [2600HM11E](#)