

# NR01 Series Process Sealed Rotaries



**Subminiature Rotaries with  
Positive, Distinctive Detent**

# General Specifications

## Electrical Capacity (Resistive Load)

**Logic Level:** 0.4VA maximum @ 28V AC/DC maximum  
(Applicable Range 0.1mA ~ 0.1A @ 20mV ~ 28V)  
Note: Find additional explanation of operating range in Supplement section

## Other Ratings

**Contact Resistance:** 100 milliohms maximum  
**Insulation Resistance:** 100 megohms minimum @ 500V DC  
**Dielectric Strength:** 500V AC minimum for 1 minute minimum  
**Mechanical Life:** 30,000 cycles minimum  
**Electrical Life:** 10,000 cycles minimum  
**Nominal Operating Torque:** 0.02Nm (0.177 lb•in)  
**Contact Timing:** Nonshorting  
**Indexing:** 45° for 3-position, 4-position & 5-position

## Materials & Finishes

**Housing:** Glass fiber reinforced polyester (PBT)  
**Base:** Glass fiber reinforced polyamide  
**Rotor:** Polyacetal  
**Movable Contactor:** Beryllium copper with gold plating  
**Stationary Contacts:** Phosphor bronze with gold plating  
**Terminals:** Phosphor bronze with gold plating  
**Mounting Bracket:** Steel with tin plating

## Environmental Data

**Operating Temperature Range:** -25°C through +70°C (-13°F through +158°F)  
**Humidity:** 90 ~ 95% humidity for 96 hours @ 40°C (104°F)  
**Vibration:** 10 ~ 55Hz with peak-to-peak amplitude of 1.5mm traversing the frequency range & returning in 1 minute; 3 right angled directions for 2 hours  
**Shock:** 50G (490m/s<sup>2</sup>) acceleration (tested in 6 right angled directions, with 5 shocks in each direction)

## PCB Processing

**Soldering:** Wave Soldering Recommended: Preheat temperature 110°C; Preheat time 40 seconds; Peak Temperature 270°C; Peak Time 6 seconds; Thickness of PCB 1.6mm; 2 Cycles.  
Manual Soldering Recommended: Temperature 390°C for 4 seconds, 2 cycles.  
**Cleaning:** Automated cleaning. See Cleaning Specifications in Supplement section.

## Standards & Certifications

The NR01 Series rotaries have not been tested for UL recognition or CSA certification. These switches are designed for use in a low-voltage, low-current, logic-level circuit. When used as intended in a logic-level circuit, the results do not produce hazardous energy.

Note: Values are determined by NKK's individual specification tests in a controlled environment, and do not certify that the product supports simultaneous multiple conditions.

# Distinctive Characteristics

Totally sealed construction with internal o-ring, gasket between base and housing, and insert-molded terminals, gives protection for automated processing techniques.

Detent mechanism, with its spring-operated steel ball, gives distinct feel and crisp actuation for accurate switch setting.

Subminiature size and compact body contributes to high density mounting.

Bifurcated, self-wiping contact mechanism provides unequalled logic-level reliability and smoother, positive detent actuation.

Crimped bracket legs ensure secure PCB mounting and prevent dislodging during automated wave soldering.

Molded-in terminals prevent entry of flux and other contaminants.

.100" x .100" (2.54mm x 2.54mm) terminal spacing conforms to standard PC board grid spacing.

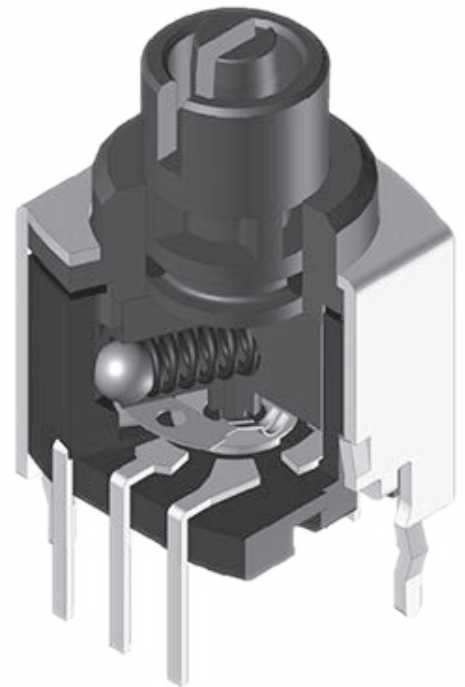

## Applications

- Power Control Equipment
- Measuring Devices
- Telecommunication Equipment
- Medical Equipment
- Teaching Pendant

## Actual Size

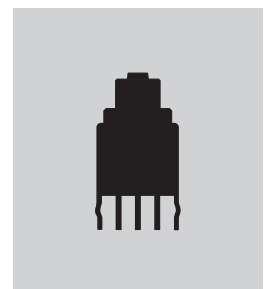

### TYPICAL SWITCH ORDERING EXAMPLE

**NR01** **1** **03** **A** **N** **G** **13** — **1** **C**

**Pole**  
1 Single Pole

**Contact Timing**  
N Nonshorting

**Contact Material**  
G Gold Rated  
0.4VA @  
28V AC/DC

**PC Terminals**  
13 Straight with Bracket

**Colors**

A	Black
C	Red
H	Gray

**Circuits, Positions & Indexing**

Code	Pos. 1	Pos. 2	Pos. 3	Pos. 4	Pos. 5	Index
03	ON	ON	ON	—	—	45°
04	ON	ON	ON	ON	—	45°
05	ON	ON	ON	ON	ON	45°

**Knobs**

No Code	Without Knob
1	Knob Without Flange
2	Knob With Flange

**DESCRIPTION FOR TYPICAL ORDERING EXAMPLE**  
**NR01103ANG13-1C**

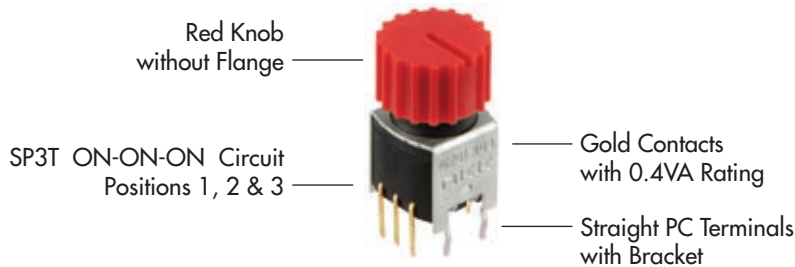

### POLES & CIRCUITS

Pole	Model	Actuator Positions					Connected Terminals					Throw & Schematics
		Pos 1	Pos 2	Pos 3	Pos 4	Pos 5	Pos 1	Pos 2	Pos 3	Pos 4	Pos 5	Note: Terminal numbers are not actually on switch
SP3T	NR01103	ON	ON	ON	—	—	C-2	C-3	C-4	—	—	
SP4T	NR01104	ON	ON	ON	ON	—	C-2	C-3	C-4	C-5	—	
SP5T	NR01105	ON	ON	ON	ON	ON	C-1	C-2	C-3	C-4	C-5	

### CONTACT MATERIAL & RATING

**G** Gold over Bronze or Copper  
Logic Level  
0.4VA @ 28V AC/DC maximum

### TERMINALS

**13** Straight PC with Bracket

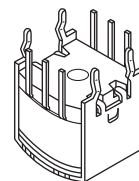

## TYPICAL SWITCH DIMENSIONS

### 45° Indexing • SP3T • Straight PC

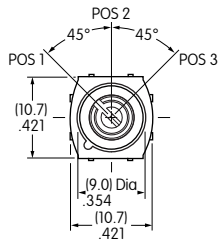

Actuator shown in Position 1

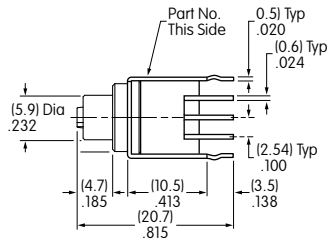

Terminals 1 & 5 are support pins

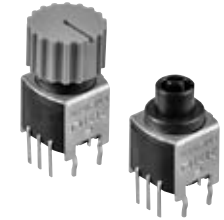
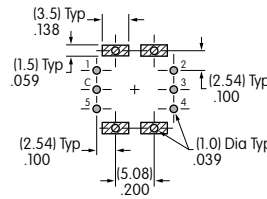
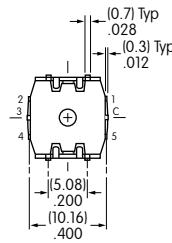

NR01103ANG13-1C

### 45° Indexing • SP4T • Straight PC

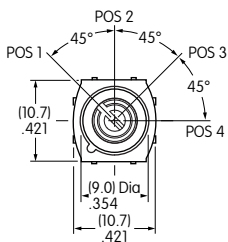

Actuator shown in Position 1

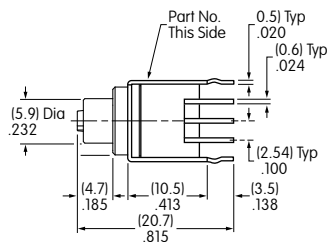

Terminal 1 is a support pin

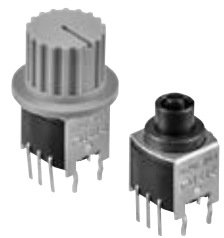
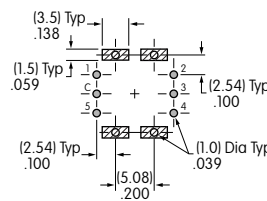
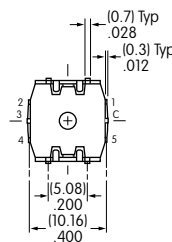

NR01104ANG13-2C

### 45° Indexing • SP5T • Straight PC

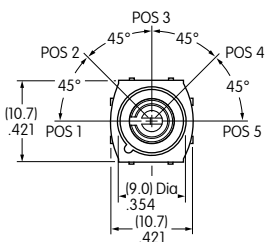

Actuator shown in Position 1

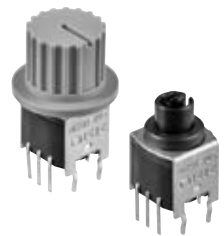
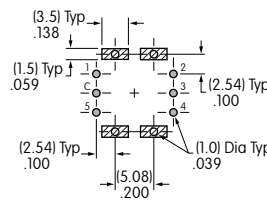
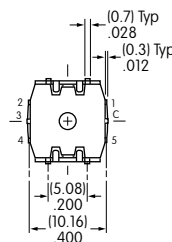
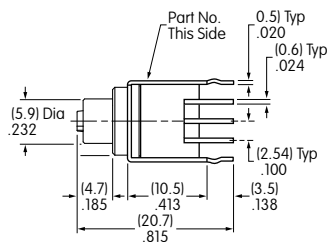

NR01105ANG13-2C

## KNOBS

**No Code**

Without Knob

**1** AT3008 Without Flange

Material:  
Glass fiber reinforced polyamide

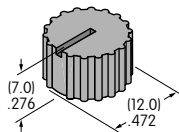

**2** AT3009 With Flange

Material:  
Glass fiber reinforced polyamide

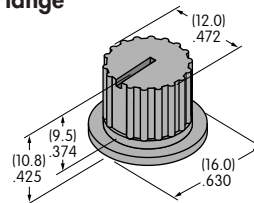

Knob Colors

- A** Black
- C** Red
- H** Gray

## MOUNTING & INSTALLATION

### Knob Installation

To prevent knob from disassembling from the switch, it is recommended to use the type with a flange. Mount the knob with the flange (AT3009, assembled to switch) beneath the panel, as shown in illustration.

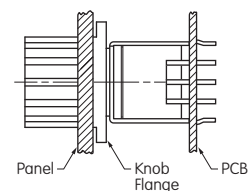

Ideal for Applications that Require Small Sizes with Precision & Reliability

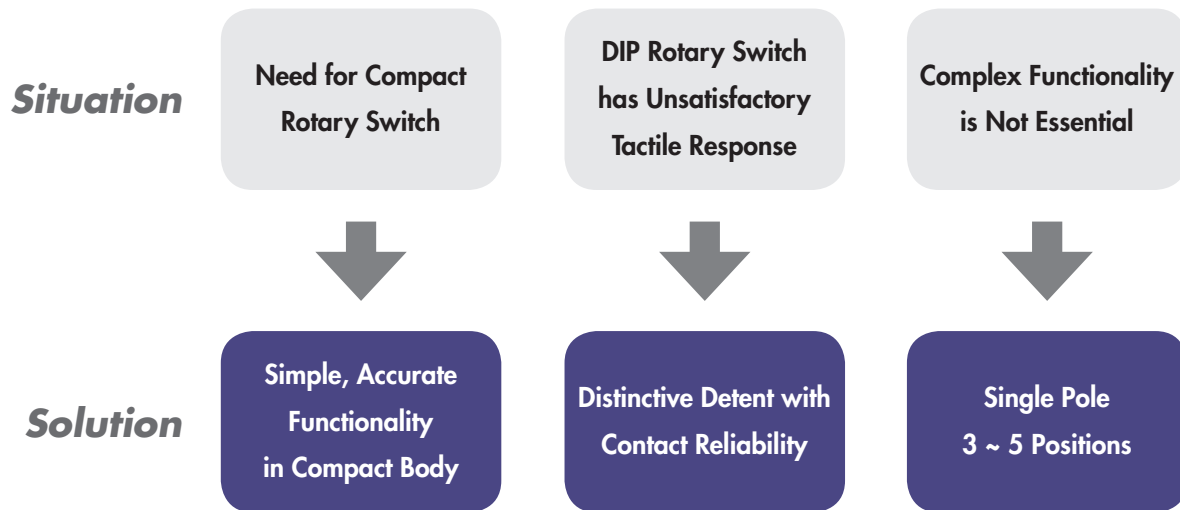

### Advantages

- Simplified soldering and automated cleaning processes enhance production efficiency
- Reinforced bracket with crimped legs improves mounting stability and strength
- Easy, straightforward functionality
- Small, subminiature size with precise detent and crisp actuation

### Typical Applications



Switching Function

F1, F2, F3, F4

Handheld Automation Devices



Input Switching





AC, DC, GND

Signal Mode Selection

CH1, CH2, DUAL

Measuring Devices

A Comprehensive Line of Rotary Switches Meets a Variety of Applications

PCB Mount Rotaries	NR01	MRB	MRA112	FR01
Specifications				
Number of Poles	1	1	1, 2, 4	—
Positions	3, 4, 5	2, 3	2 ~ 12	—
Electrical Capacity	0.4VA Max @ 28V AC/DC Max	0.4VA Max @ 28V AC/DC Max	250mA @ 125V AC	100mA @ 5V DC
Electrical Life	10,000 Operations Min	10,000 Operations Min	10,000 Operations Min	10,000 Detent Operations Min
Operating Temperature	-25 ~ +70°C (-13 ~ +158°F)	-10 ~ +70°C (+14 ~ +158°F)	-10 ~ +70°C (+14 ~ +158°F)	-25 ~ +85°C (-13 ~ +185°F)
External Dimensions	10.7 x 10.7mm (.421 x .421")	14.5 x 15.74mm (.571 x .620")	16mm Dia (.630" Dia)	10.0 x 10.0mm (.394 x .394")
Process Sealed	Yes	Yes	Yes	No

**Subminiature & Ultra-Miniature DIP Rotaries**

**FR01**



- 10mm
- Ultra-Thin
- 100mA @ 5/50V DC
- Subminiature

**ND**



- 8mm
- Process Sealed
- 100mA @ 5/50V DC
- Ultra-Miniature

**SMT DIP Rotaries**

**FR02**



- 10mm
- Ultra-Thin
- 100mA @ 5/50V DC
- Subminiature

**ND3**



- 8mm
- Process Sealed
- 100mA @ 5/50V DC
- Ultra-Miniature

**Miniature & Subminiature Rotaries**

**NEW NR01**



- Process Sealed
- Positive Detent
- 0.4VA @ 28V AC/DC
- Subminiature

**MRX**



- Positive Detent
- Metal Bushing & Housing
- 1A @ 30V DC
- Miniature

**MRB**



- Process Sealed
- IP67 Rated
- 0.4VA @ 28V AC/DC
- Miniature

**Standard Rotaries with Multiple Positions & Poles**

**HS13**



- 6A @ 125V AC
- 10mm Bushing

**TS**



- 6A @ 125/250V AC
- 10mm Bushing

**HS16**



- 12A @ 125V AC
- 10mm Bushing

**PS**



- 30A @ 125/250V AC
- 10mm Bushing

NKK offers optional knobs for Rotary Switches. See Accessories or contact our Sales Department.

Effective Date July 2017



http://www.nkkswitches.com • 1.877.2BUYNKK (228.9655)  
 7850 East Gelding Drive • Scottsdale, AZ 85260 • Telephone 480.991.0942 • Fax 480.998.1435



## **X-ON Electronics**

Largest Supplier of Electrical and Electronic Components

*Click to view similar products for [Knobs & Dials](#) category:*

*Click to view products by [NKK Switches](#) manufacturer:*

Other Similar products are found below :

[0195316-051](#) [790-1030](#) [790-1202](#) [790-2226](#) [8519](#) [8529](#) [8547](#) [85-559](#) [8573](#) [11K5015-EMNB](#) [11K5019-ECNB](#) [11K5020-KLAB](#) [11K5048-KMNB](#) [11K5014-EMNB](#) [11K5015-EMNG](#) [11K5019-EMNB](#) [MS91528-2N2B](#) [1770](#) [P400S-08-D6-N](#) [K6510](#) [KNP700A1/4](#) [3045B](#)  
[AR22PY-122B](#) [PKJ50B18](#) [277A](#) [348003](#) [42000B38](#) [420114B14](#) [5006](#) [56008-001](#) [KS700B14](#) [411](#) [420037B14](#) [WA-101C-P](#) [WA-102B](#)  
[WA-103](#) [WA-109B](#) [WA-1450-P](#) [WA-1550](#) [WA-1600-P](#) [WA-2300](#) [WA-4100](#) [WA-4108-P](#) [0166736-006](#) [0195316-052](#) [0703006-003](#)  
[0744386-211](#) [52-928.20](#) [52-928.60](#) [52-928.9](#)