

## FT Series

# 4-Wire Analog Resistive Touch Screens with FPC Tails

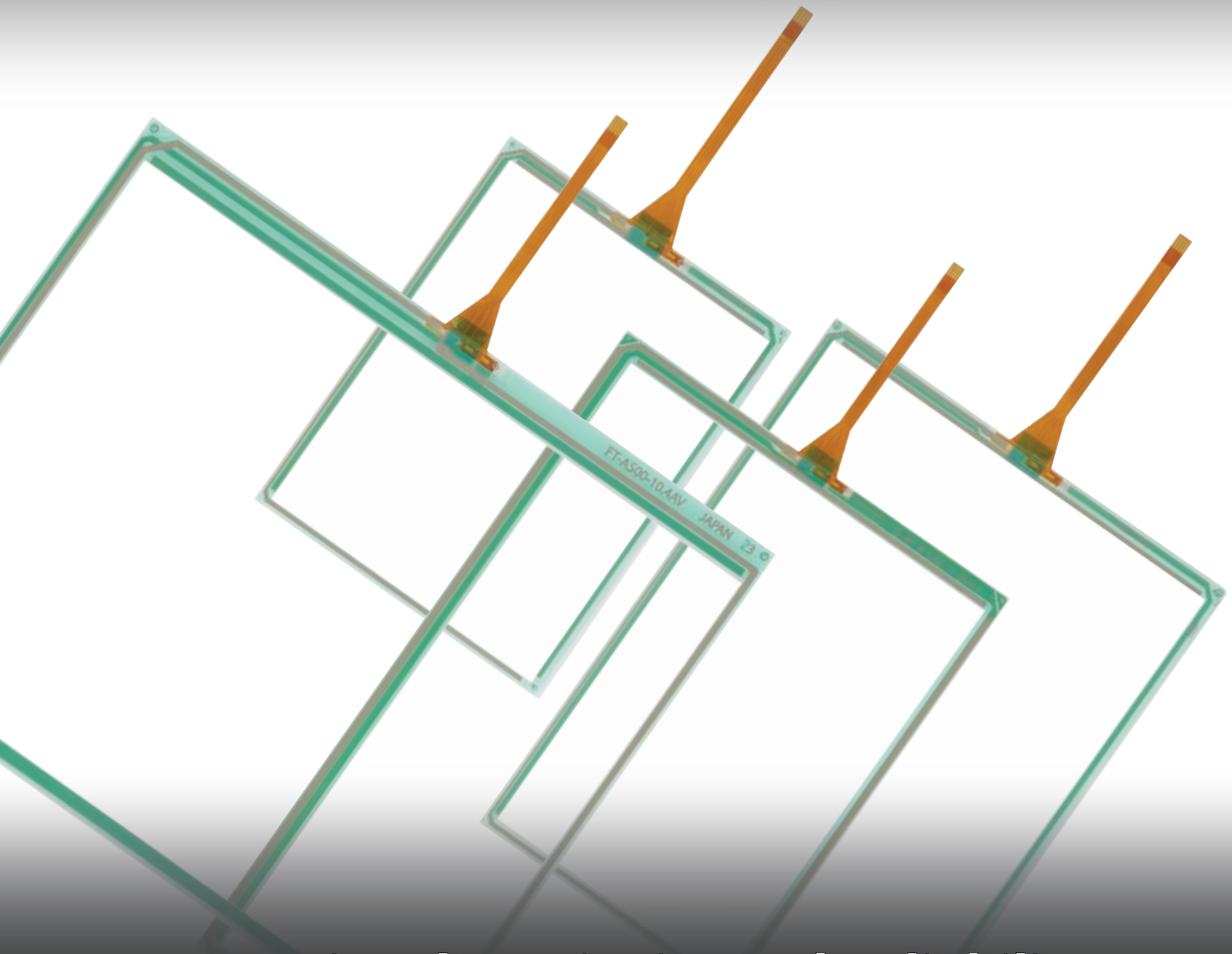

**Exceptional Continuity and Reliability**

### DISTINCTIVE CHARACTERISTICS

- Expansion of FT Series includes wider, larger, narrow frame types with FPC tails, offering increased continuity and reliability
- Touch screens with FPC tails have decreased tail width; connector pins change from 8 pin with 1.25mm pitch to 4 pin with 1.0mm pitch
- Tail material upgraded to polyimide resin from polyethylene terephthalate (PET), ensuring advanced flexibility, strength and resilience against heat
- Construction of film and glass with superior durability and flexibility
- Choice of input methods: finger or stylus
- Wide range of panel sizes and tail positions, including 5.7", 6.5", 8.4", 10.4", 10.6", 12.1", 15", 15.6" and 19"
- Anti-Newton Ring (ANR) Technology eliminates many of the typical visual artifacts
- Operator can easily direct the device without specialized technical training or computer knowledge by combining touch screen to LCD panel, plasma EL or other display
- Touch screens support flexible design, including digital and analog, in a variety of sizes and relatively low cost
- Anti-glare surface reduces reflection from fluorescent lighting, sunlight; hard resin coating ensures excellent protection against scratches or damage
- Adhesive layer between glass and film has improved durability to withstand diverse environmental conditions

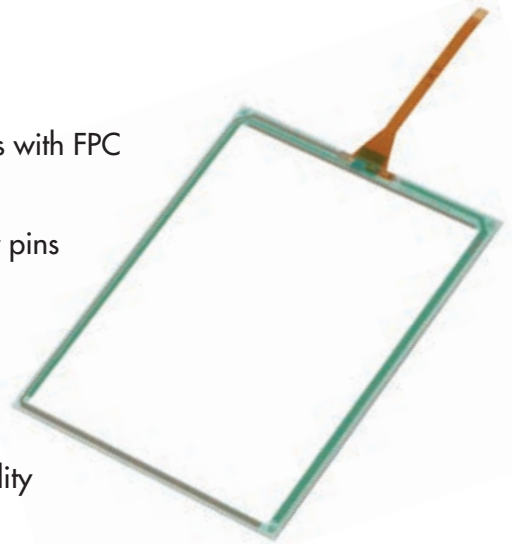

### APPLICATIONS

- Office Automation
- Industrial Automation
- Information Technology
- Banking Systems
- Broadcast
- Hospitality
- Gaming/Entertainment
- Medical Equipment

Note: Contact NKK Switches regarding use of FT Touch Screens for medical equipment.

### Cross Section View of Touch Screen

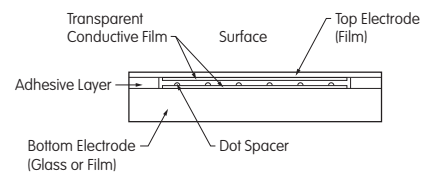

### Specializing in Custom Products

- Custom sizes for Resistive Touch Screens
- Capability to attach touch screens to LCDs or other components
- Specializing in custom construction such as film plus film combinations
- Fingerprint resistant, high transmittance films

### Control Board for Analog Touch Panels

- Combining an analog touch panel with a controller board device driver on a computer enables performing the same operations as with a mouse by touching the touch panel screen
- NKK offers controller boards compatible with USB or with RS232C

TYPICAL TOUCH SCREEN ORDERING EXAMPLE

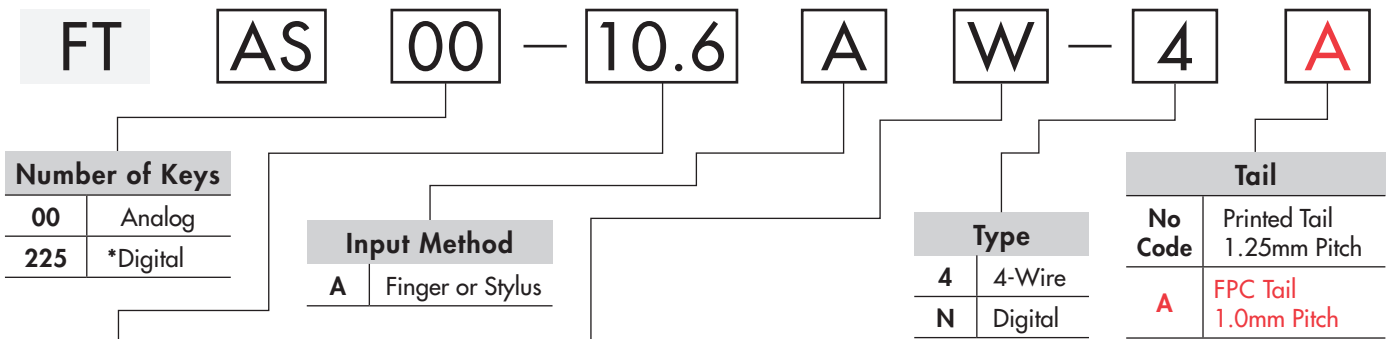

**Number of Keys**

|     |          |
|-----|----------|
| 00  | Analog   |
| 225 | *Digital |

**Input Method**

|   |                  |
|---|------------------|
| A | Finger or Stylus |
|---|------------------|

**Type**

|   |         |
|---|---------|
| 4 | 4-Wire  |
| N | Digital |

**Tail**

|         |                              |
|---------|------------------------------|
| No Code | Printed Tail<br>1.25mm Pitch |
| A       | FPC Tail<br>1.0mm Pitch      |

**Screen Size**

|      |       |
|------|-------|
| 5.7  | 5.7"  |
| 6.5  | 6.5"  |
| 8.4  | 8.4"  |
| 10.4 | 10.4" |
| 10.6 | 10.6" |
| 12.1 | 12.1" |
| 15   | 15.0" |
| 15.6 | 15.6" |
| 19   | 19.0" |

**\*\*Position of Tail (Analog)**

|         |                                  |
|---------|----------------------------------|
| No Code | Left or Right (Horizontal)       |
| V       | Top or Bottom (Vertical)         |
| S       | Narrow Frame Type 1 (Horizontal) |
| N       | Narrow Frame Type 2 (Horizontal) |
| W       | Wide Type (Horizontal)           |

\*\* Aspect Ratio:  
Narrow Frame: 4:3  
Wide Frame: 16:9

\*Digital type only applicable to FTAS225-5.7A-N (printed tail)

DESCRIPTION FOR TYPICAL ORDERING EXAMPLE

FTAS00-10.6AW-4A

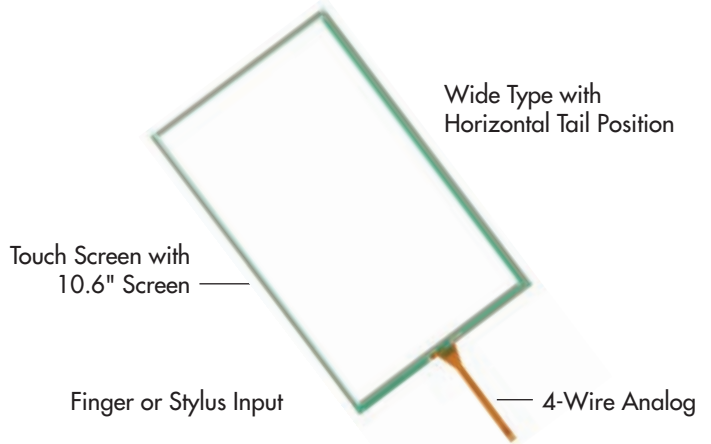









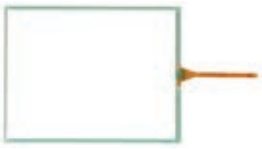

GENERAL SPECIFICATIONS

| 4-Wire Analog Resistive Touch Screens |                                                                                                 |
|---------------------------------------|-------------------------------------------------------------------------------------------------|
| Power Level                           | 1mA @ 5V DC (resistive load)                                                                    |
| XY Resistive Value                    | Narrow: 250 ~ 850Ω Wide: 120 ~ 1,500Ω                                                           |
| Linearity                             | ±1.5% maximum                                                                                   |
| Insulation Impedance                  | 10MΩ minimum @ 25V DC                                                                           |
| Expected Operational Life             | Writing: 50,000 operations minimum (approximately 30mm movement with stylus)                    |
|                                       | Tapping: 1,000,000 operations minimum (pressing force 4.9N using silicone rubber, hardness 60°) |
| Touch Activation Force                | 1.47N maximum                                                                                   |
| Chattering Time                       | 10 milliseconds maximum                                                                         |
| Relative Humidity                     | +60°C (+140°F), humidity 90%, 240 hours                                                         |
| Operating Temperature Range           | -20°C ~ +70°C (-4°F ~ +158°F)                                                                   |
| Storage Temperature Range             | -40°C ~ +80°C (-40°F ~ +176°F)                                                                  |
| Light Transmission                    | 80% standard (Touch Panel portion)                                                              |
| Surface Hardness                      | 2H minimum (JIS K5600)                                                                          |

Note: Values are determined by NKK's individual specification tests in a controlled environment, and do not certify that the product supports simultaneous multiple conditions.

### PART NUMBERS & DESCRIPTIONS

|                                                                                   |                                                                                   |                                                                                     |                                                                                     |
|-----------------------------------------------------------------------------------|-----------------------------------------------------------------------------------|-------------------------------------------------------------------------------------|-------------------------------------------------------------------------------------|
|  |  |   |  |
| <b>FTAS00-5.7AS-4A</b>                                                            | <b>FTAS00-6.5AS-4A</b>                                                            | <b>FTAS00-8.4AS-4A</b>                                                              | <b>FTAS00-10.4AS-4A</b>                                                             |
|  |  |   |  |
| <b>FTAS00-10.4AV-4A</b>                                                           | <b>FTAS00-10.6AW-4A</b>                                                           | <b>FTAS00-12.1AN-4A</b>                                                             | <b>FTAS00-12.1AW-4A</b>                                                             |
|  |  |  |                                                                                     |
| <b>FTAS00-15AN-4A</b>                                                             | <b>FTAS00-15.6AW-4A</b>                                                           | <b>FTAS00-19AN-4A</b>                                                               |                                                                                     |

#### 4-Wire Analog Touch Screens

| Tail                                   | Part Number             | Screen Size in Inches | Key Area Dimensions                      | Viewing Area Dimensions                  | External Dimensions                      | Panel Thickness  | Terminal Detail<br>4 Pin<br>.039" (1.0mm) Pitch |
|----------------------------------------|-------------------------|-----------------------|------------------------------------------|------------------------------------------|------------------------------------------|------------------|-------------------------------------------------|
| Narrow Frame Type 1<br>Horizontal Tale | <b>FTAS00-5.7AS-4A</b>  | 5.7                   | 4.535" x 3.402"<br>(115.2mm x 86.4mm)    | 4.764" x 3.606"<br>(121.0mm x 91.6mm)    | 5.157" x 3.976"<br>(131.0mm x 101.0mm)   | .055"<br>(1.4mm) | Length<br>3.150" (80.0mm)                       |
|                                        | <b>FTAS00-6.5AS-4A</b>  | 6.5                   | 5.197" x 3.898"<br>(132.0mm x 99.0mm)    | 5.433" x 4.134"<br>(138.0mm x 105.0mm)   | 5.906" x 4.567"<br>(150.0mm x 116.0mm)   | .055"<br>(1.4mm) | Length<br>3.150" (80.0mm)                       |
|                                        | <b>FTAS00-8.4AS-4A</b>  | 8.4                   | 6.728" x 5.102"<br>(170.9mm x 129.6mm)   | 6.949" x 5.331"<br>(176.5mm x 135.4mm)   | 7.343" x 5.685"<br>(186.5mm x 144.4mm)   | .083"<br>(2.1mm) | Length<br>3.150" (80.0mm)                       |
|                                        | <b>FTAS00-10.4AS-4A</b> | 10.4                  | 8.315" x 6.236"<br>(211.2mm x 158.4mm)   | 8.465" x 6.394"<br>(215.0mm x 162.4mm)   | 8.882" x 6.748"<br>(225.6mm x 171.4mm)   | .083"<br>(2.1mm) | Length<br>3.150" (80.0mm)                       |
| Vertical Tale                          | <b>FTAS00-10.4AV-4A</b> | 10.4                  | 8.354" x 6.276"<br>(212.2mm x 159.4mm)   | 8.520" x 6.433"<br>(216.4mm x 163.4mm)   | 8.917" x 7.205"<br>(226.5mm x 183.0mm)   | .083"<br>(2.1mm) | Length<br>3.150" (80.0mm)                       |
| Narrow Frame Type 2<br>Horizontal Tale | <b>FTAS00-12.1AN-4A</b> | 12.1                  | 9.677" x 7.256"<br>(245.8mm x 184.3mm)   | 9.827" x 7.406"<br>(249.6mm x 188.1mm)   | 10.236" x 7.795"<br>(260.0mm x 198.0mm)  | .083"<br>(2.1mm) | Length<br>3.150" (80.0mm)                       |
|                                        | <b>FTAS00-15AN-4A</b>   | 15.0                  | 11.972" x 8.980"<br>(304.1mm x 228.1mm)  | 12.130" x 9.138"<br>(308.1mm x 232.1mm)  | 12.669" x 9.665"<br>(321.8mm x 245.5mm)  | .083"<br>(2.1mm) | Length<br>3.150" (80.0mm)                       |
|                                        | <b>FTAS00-19AN-4A</b>   | 19.0                  | 14.815" x 11.850"<br>(376.3mm x 301.0mm) | 15.039" x 12.102"<br>(382.0mm x 307.4mm) | 15.571" x 12.638"<br>(395.5mm x 321.0mm) | .083"<br>(2.1mm) | Length<br>3.150" (80.0mm)                       |
| Wide Type<br>Horizontal Tale           | <b>FTAS00-10.6AW-4A</b> | 10.6                  | 9.071" x 5.441"<br>(230.4mm x 138.2mm)   | 9.189" x 5.563"<br>(233.4mm x 141.3mm)   | 9.756" x 6.094"<br>(247.8mm x 154.8mm)   | .083"<br>(2.1mm) | Length<br>3.150" (80.0mm)                       |
|                                        | <b>FTAS00-12.1AW-4A</b> | 12.1                  | 10.280" x 6.425"<br>(261.12mm x 163.2mm) | 10.404" x 6.551"<br>(264.26mm x 166.4mm) | 10.827" x 6.929"<br>(275.0mm x 176.0mm)  | .083"<br>(2.1mm) | Length<br>3.150" (80.0mm)                       |
|                                        | <b>FTAS00-15.6AW-4A</b> | 15.6                  | 13.551" x 7.618"<br>(344.2mm x 193.5mm)  | 13.681" x 7.748"<br>(347.5mm x 196.8mm)  | 14.276" x 8.433"<br>(362.6mm x 214.2mm)  | .083"<br>(2.1mm) | Length<br>3.150" (80.0mm)                       |

TYPICAL DIMENSIONS

Vertical Frame

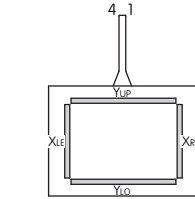
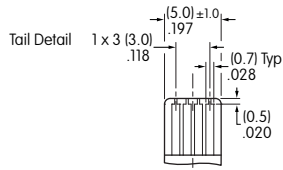

Y<sub>UP</sub>, Y<sub>LO</sub>: Bottom Electrode Terminal  
X<sub>LE</sub>, X<sub>RI</sub>: Top Electrode Terminal

| Pins | Signal          |
|------|-----------------|
| 1    | Y <sub>UP</sub> |
| 2    | Y <sub>LO</sub> |
| 3    | X <sub>LE</sub> |
| 4    | X <sub>RI</sub> |

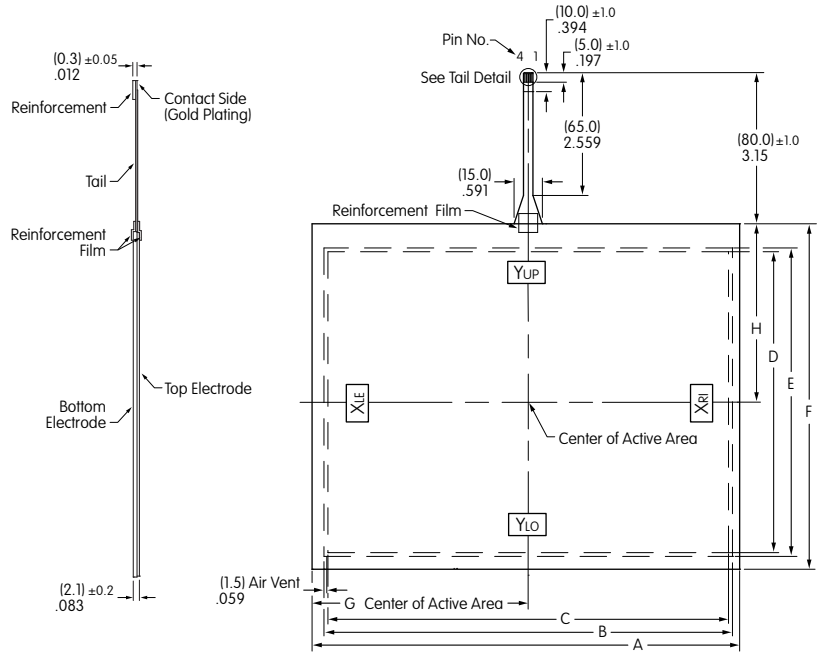

Typical Dimensions for Vertical Frame

| Part Number      | Screen Size in Inches | Dim A                | Dim B Viewable Area | Dim C Active Area | Dim D Active Area | Dim E Viewable Area | Dim F                | Dim G Center of Active Area (Horizontal) | Dim H Center of Active Area (Vertical) |
|------------------|-----------------------|----------------------|---------------------|-------------------|-------------------|---------------------|----------------------|------------------------------------------|----------------------------------------|
| FTAS00-10.4AV-4A | 10.4                  | 8.917" (226.5±0.3mm) | 8.520" (216.4mm)    | 8.354" (212.2mm)  | 6.276" (159.4mm)  | 6.433" (163.4mm)    | 7.205" (183.0±0.3mm) | 4.508" (114.5mm)                         | 3.720" (94.5mm)                        |

TYPICAL DIMENSIONS

Wide Horizontal Frame

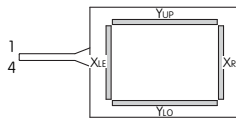
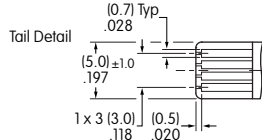

Y<sub>UP</sub>, Y<sub>LO</sub>: Bottom Electrode Terminal  
X<sub>LE</sub>, X<sub>RI</sub>: Top Electrode Terminal

| Pins | Signal          |
|------|-----------------|
| 1    | Y <sub>UP</sub> |
| 2    | Y <sub>LO</sub> |
| 3    | X <sub>LE</sub> |
| 4    | X <sub>RI</sub> |

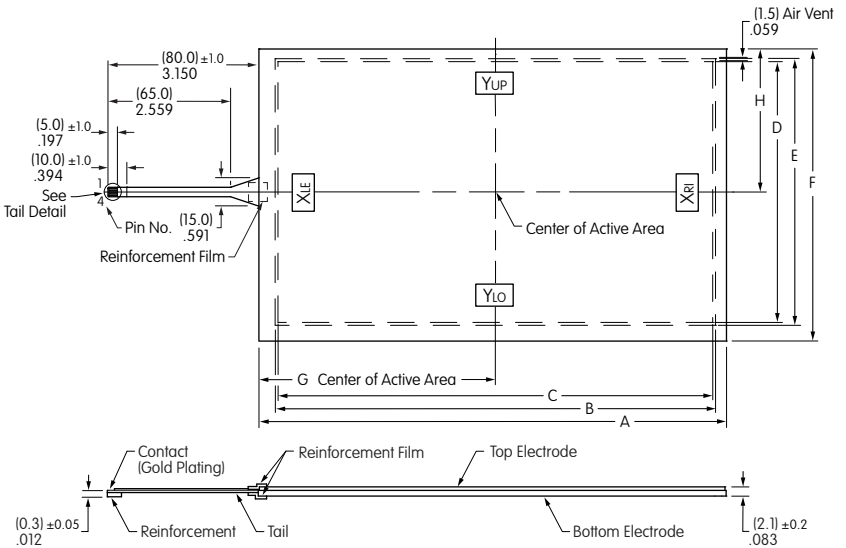

Typical Dimensions for Wide Horizontal Frame

| Part Number      | Screen Size in Inches | Dim A                 | Dim B Viewable Area | Dim C Active Area  | Dim D Active Area | Dim E Viewable Area | Dim F                | Dim G Center of Active Area (Horizontal) | Dim H Center of Active Area (Vertical) |
|------------------|-----------------------|-----------------------|---------------------|--------------------|-------------------|---------------------|----------------------|------------------------------------------|----------------------------------------|
| FTAS00-10.6AW-4A | 10.4                  | 8.917" (247.8±0.3mm)  | 8.520" (233.4mm)    | 8.354" (230.4mm)   | 6.276" (138.2mm)  | 6.433" (141.3mm)    | 7.205" (154.8±0.3mm) | 4.508" (125.3mm)                         | 3.720" (75.8mm)                        |
| FTAS0012.1AW-4A  | 12.1                  | 10.827" (275.0±0.3mm) | 10.404" (264.26mm)  | 10.280" (261.12mm) | 6.425" (163.2mm)  | 6.551" (166.4mm)    | 6.929" (176±0.3mm)   | 5.468" (138.89mm)                        | —                                      |
| FTAS0015.6AW-4A  | 15.6                  | 14.276" (362.6±0.3mm) | 13.681" (347.5mm)   | 13.551" (344.2mm)  | 7.618" (193.5mm)  | 7.748" (196.8mm)    | 8.433" (214.2±0.3mm) | 7.138" (181.3mm)                         | —                                      |

## TYPICAL DIMENSIONS

### Narrow Frame & Horizontal Tail

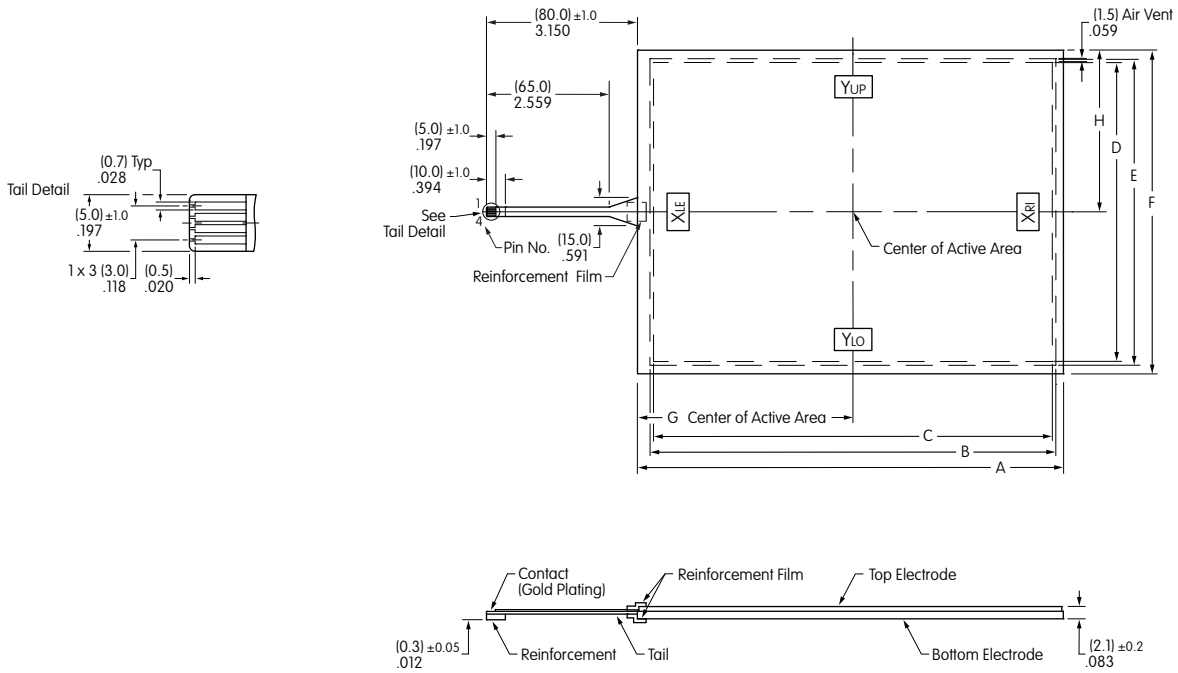

| Pins | Signal          |
|------|-----------------|
| 1    | Y <sub>UP</sub> |
| 2    | Y <sub>LO</sub> |
| 3    | X <sub>LE</sub> |
| 4    | X <sub>RI</sub> |

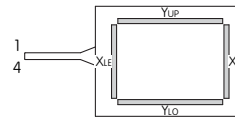

Y<sub>UP</sub>, Y<sub>LO</sub>: Bottom Electrode Terminal  
X<sub>LE</sub>, X<sub>RI</sub>: Top Electrode Terminal

### Typical Dimensions for Narrow Frame

| Part Number             | Screen Size in Inches | Dim A                    | Dim B Viewable Area  | Dim C Active Area    | Dim D Active Area    | Dim E Viewable Area  | Dim F                    | Dim G Center of Active Area (Horizontal) | Dim H Center of Active Area (Vertical) |
|-------------------------|-----------------------|--------------------------|----------------------|----------------------|----------------------|----------------------|--------------------------|------------------------------------------|----------------------------------------|
| <b>FTAS00-5.7AS-4A</b>  | 5.7                   | 5.157"<br>(131.0±0.3mm)  | 4.764"<br>(121.0mm)  | 4.535"<br>(115.2mm)  | 3.402"<br>(86.4mm)   | 3.606"<br>(91.6mm)   | 3.976"<br>(101.0±0.3mm)  | 2.648"<br>(67.25mm)                      | —                                      |
| <b>FTAS00-6.5AS-4A</b>  | 6.5                   | 5.906"<br>(150.0±0.3mm)  | 5.433"<br>(138.0mm)  | 5.197"<br>(132.0mm)  | 3.898"<br>(99.0mm)   | 4.134"<br>(105.0mm)  | 4.567"<br>(116.0±0.3mm)  | 3.031"<br>(77.0mm)                       | —                                      |
| <b>FTAS00-8.4AS-4A</b>  | 8.4                   | 7.343"<br>(186.5±0.3mm)  | 6.949"<br>(176.5mm)  | 6.728"<br>(170.9mm)  | 5.102"<br>(129.6mm)  | 5.331"<br>(135.4mm)  | 5.685"<br>(144.4±0.3mm)  | 3.734"<br>(94.85mm)                      | —                                      |
| <b>FTAS00-10.4AS-4A</b> | 10.4                  | 8.882"<br>(225.6±0.3mm)  | 8.465"<br>(215.0mm)  | 8.315"<br>(211.2mm)  | 6.236"<br>(158.4mm)  | 6.394"<br>(162.4mm)  | 6.748"<br>(171.4±0.3mm)  | 4.492"<br>(114.1mm)                      | —                                      |
| <b>FTAS00-12.1AN-4A</b> | 12.1                  | 10.236"<br>(260.0±0.3mm) | 9.827"<br>(249.6mm)  | 9.677"<br>(245.8mm)  | 7.256"<br>(184.3mm)  | 7.406"<br>(188.1mm)  | 7.795"<br>(198.0±0.3mm)  | 5.177"<br>(131.5mm)                      | 3.850"<br>(97.8mm)                     |
| <b>FTAS00-15AN-4A</b>   | 15.0                  | 12.669"<br>(321.8±0.3mm) | 12.130"<br>(308.1mm) | 11.972"<br>(304.1mm) | 8.980"<br>(228.1mm)  | 9.138"<br>(232.1mm)  | 9.665"<br>(245.5±0.3mm)  | 6.398"<br>(162.5mm)                      | —                                      |
| <b>FTAS00-19AN-4A</b>   | 19.0                  | 15.571"<br>(395.5±0.3mm) | 15.039"<br>(382.0mm) | 14.815"<br>(376.3mm) | 11.850"<br>(301.0mm) | 12.102"<br>(307.4mm) | 12.638"<br>(321.0±0.3mm) | 7.799"<br>(198.1mm)                      | —                                      |

Controller Board for RS232C

FTCS04C

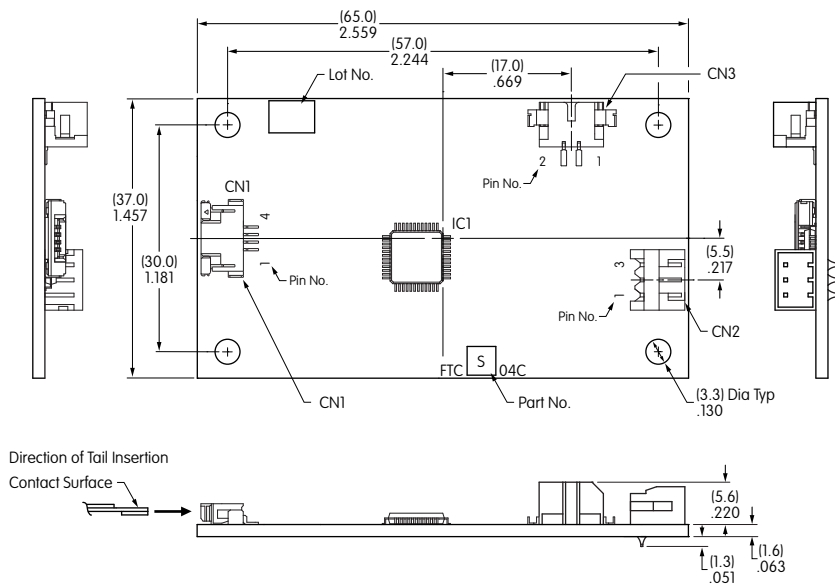

CN1 4-Wire Analog Touch Screen Connector - 4 Pins

| Pin No. | Symbol | Description                            |
|---------|--------|----------------------------------------|
| 1       | Y0     | For Y <sub>UP</sub> or Y <sub>LO</sub> |
| 2       | Y1     |                                        |
| 3       | X0     | For X <sub>RI</sub> or X <sub>LE</sub> |
| 4       | X1     |                                        |

CN2 RS232C Header Connector - 3 Pins

| Controller Board Side |        |                     |                |
|-----------------------|--------|---------------------|----------------|
| Pin No.               | Symbol | Description         | Computer Side  |
| 1                     | RD     | Receiving Data (IN) | Sending Data   |
| 2                     | SD     | Sending Data (OUT)  | Receiving Data |
| 3                     | GND    | GND                 | GND            |

CN3 Header Connector for Power Supply - 2 Pins

| Pin No. | Symbol          | Description    |
|---------|-----------------|----------------|
| 1       | V <sub>CC</sub> | Supply Voltage |
| 2       | GND             | GND            |

Controller Board for USB

FTCU04C

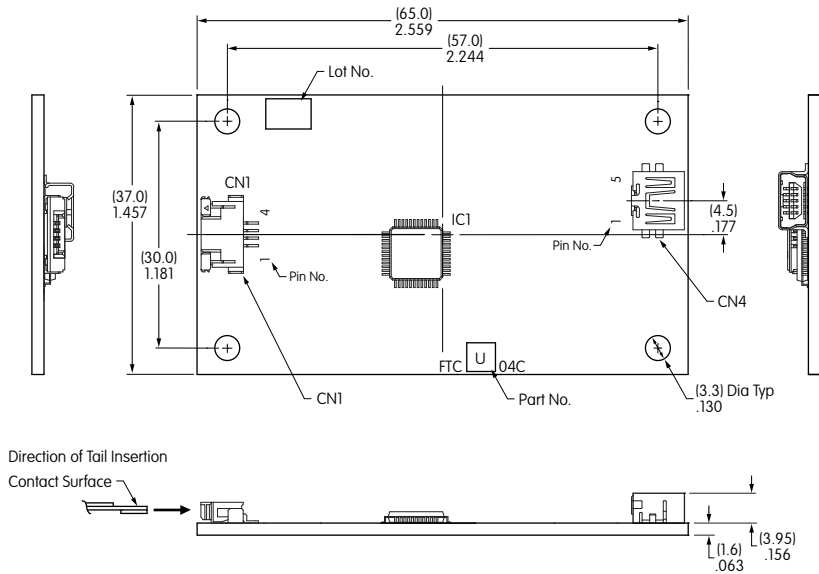

CN1 4-Wire Analog Touch Screen Connector - 4 Pins

| Pin No. | Symbol | Description                            |
|---------|--------|----------------------------------------|
| 1       | Y0     | For Y <sub>UP</sub> or Y <sub>LO</sub> |
| 2       | Y1     |                                        |
| 3       | X0     | For X <sub>RI</sub> or X <sub>LE</sub> |
| 4       | X1     |                                        |

CN4 Header Connector for USB - 5 Pins

| Pin No. | Symbol          | Description         |
|---------|-----------------|---------------------|
| 1       | V <sub>CC</sub> | USB V <sub>CC</sub> |
| 2       | D <sub>-</sub>  | USB D <sub>-</sub>  |
| 3       | D <sub>+</sub>  | USB D <sub>+</sub>  |
| 4       | GND             | USB GND             |
| 5       | GND             | Shield GND          |

OPTIONAL ACCESSORIES

Receptacle Connector & Wire Assembly for RS232C

AT713 is the Receptacle Connector with code to connect to RS232C communication of the controller boards. It is compatible with FTCS04C. The cable length is adjustable.

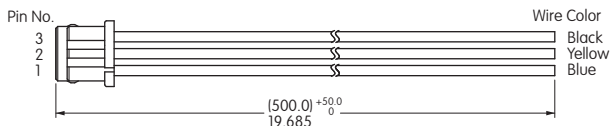

Receptacle Connector & Wire Assembly for Power Supply

AT714 is a Receptacle Connector with code to connect to FTCS04C power source of the control boards. The cable length is adjustable.

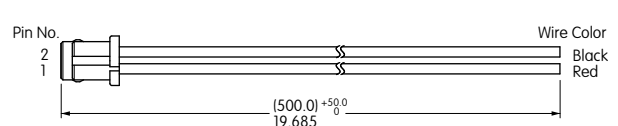



## 4-Wire Touch Screen Controller Boards & Drivers

### DISTINCTIVE CHARACTERISTICS

- Compatible with Control Board USB/RS232C
- Equipped with EPROM for Saving Setting Data
- Device Drivers are Windows 7, 8 & 10 Compatible

| Controller Boards |                |                        |
|-------------------|----------------|------------------------|
| Type              | Part No.       | Communication Protocol |
| 4-Wire            | <b>FTCS04C</b> | RS232C                 |
| 4-Wire            | <b>FTCU04C</b> | USB                    |

System Configuration for USB

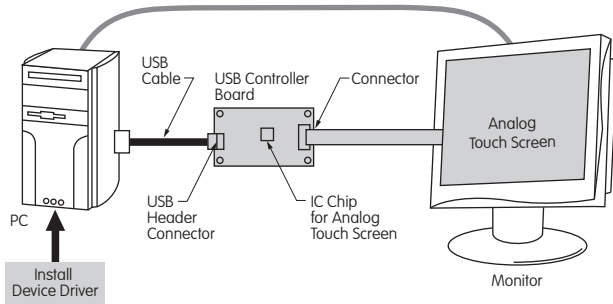

System Configuration for RS232C

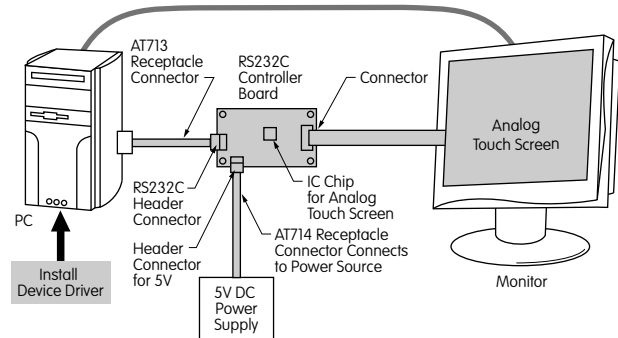

Available through NKK Switches

Touch panels can be operated the same as PC mouse functions by combining a control board or device driver and analog touch screen. For specifications or technical data for the controller boards and drivers, see NKK's web site or call our engineering support personnel.

### General Specifications

| Items                | <b>FTCS04C</b>                                   | <b>FTCU04C</b>     |
|----------------------|--------------------------------------------------|--------------------|
| Interface            | RS232C                                           | USB 2.0 Full Speed |
| Clock                | 16MHz                                            | 16MHz              |
| Supply Voltage       | 5.0V                                             | 5.0V (Bus Power)   |
| Resolution           | 10bit                                            | 10bit              |
| Current Consumption  | 40mA maximum                                     | 100mA maximum      |
| Communication Speed  | 9600 bps                                         | —                  |
| Communication Format | Data Length: 8bit<br>Parity: None<br>Stop Bit: 1 | —                  |

The controller board is designed specifically for touch screens with the FPC tails. Refer to the product data sheet for detailed specifications, available by contacting NKK Switches.

### Absolute Maximum Ratings

| Items                 | Symbols   | Minimum        | Maximum         | Notes             |
|-----------------------|-----------|----------------|-----------------|-------------------|
| Supply Voltage        | $V_{CC}$  | -0.3V          | +5.5V           | —                 |
| Input Voltage         | $V_{TP}$  | —              | $V_{CC}$        | Touch Panel Input |
|                       | $*V_{RS}$ | -15V           | +15V            | RS232C            |
| Operating Temperature | $T_{OPR}$ | -20°C<br>-4°F  | +70°C<br>+158°F | —                 |
| Storage Temperature   | $T_{STG}$ | -25°C<br>-13°F | +85°C<br>+185°F | —                 |

\* $V_{RS}$ : Applies Only to RS232C

### Recommended Values

| Items                 | Symbols   | Minimum       | Typical | Maximum         | Notes           |
|-----------------------|-----------|---------------|---------|-----------------|-----------------|
| Supply Voltage        | $V_{CC}$  | +4.75V        | +5.0    | +5.25V          | —               |
| Operating Temperature | $T_{OPR}$ | -20°C<br>-4°F | —       | +70°C<br>+158°F | No Condensation |



## IC Chip for Analog Touch Screens

## DISTINCTIVE CHARACTERISTICS

- Interface: USB and RS232C
- High Speed and Accuracy
- Built-in Calibration Function
- Data Function Removal Built In to Eliminate Noise

The IC is for use with the 4-wire transparent touch screens. When the screen is touched, it recognizes the position of the touch by the level of analog voltage detected by the A/D. The A/D converter receives the value and sends a set of coordinate values as serial data or USB.

Contact NKK Switches for the IC data sheet.

## General Specifications for IC FTCSU548

|                                                            |                                                         |
|------------------------------------------------------------|---------------------------------------------------------|
| Package                                                    | LFQFP 48 Pins                                           |
| Interface                                                  | Serial Interface (Asynchronous) or USB (Full Speed 2.0) |
| Supply Voltage                                             | 3.3/5.0V Typ; USB Available for 5V Only                 |
| * Rated Output Current                                     | High Level: -170mA<br>Low Level: +170mA                 |
| Operation Frequency                                        | 16MHz                                                   |
| A/D Converter Resolution                                   | 10bit                                                   |
| Operating Temperature                                      | -20°C ~ +85°C (-4°F ~ +185°F)                           |
| Storage Temperature                                        | -40°C ~ +125°C (-40°F ~ +257°F)                         |
| * Total Output Electric Current Amount of all the I/O Port |                                                         |

## STORAGE, HANDLING &amp; INSTALLATION

## Handling of Controller Board

- Use arc prevention to protect device from static electricity.
- Power source should be activated after host and touch panel are connected.
- When inserting connector CN1 and touch panel tail, be sure the slider of connector CN1 is pulled. Do not pull more than 10 times.
- Do not alter the product.
- Do not use any commands other than the ones outlined in the specifications.
- Place the product away from noise source (such as inverter from LCD operation) since tail can be affected by noise.
- If device driver (USB) does not work after installation, reboot the host computer while connected to the controller board.
- This product does not support suspended mode (USB).
- Protocol of USB transmission is one frame per one transaction.
- Contact factory if not using the protocol above.
- Warranty for one year after delivery. NKK warranties the 4-wire touch panel when it is used with the NKK control board and driver. Do not use third party control boards. NKK is not responsible for results of using damaged equipment with the controller boards.
- NKK Switches cannot assume responsibility for damages caused by software side during use of the touch screens.
- The touch screen pressed position may shift depending on various factors such as age, improper tail insertion or extreme temperatures. In such cases, recalibration is necessary.

## Installation

- Products are ESD sensitive and ESD protection is required.
- Do not pull on the tail. Do not apply stress to the tail area.
- Avoid vibration or shock. Avoid any force or stress that may cause deformation to the product.
- The touch screen mounting should not be loose. This may cause an adverse effect on detecting performance during operation.
- Ensure there are no burrs around the edges of the case or housing that can cause false actuation. The edges of the case or housing should not enter the keying area.

## STORAGE, HANDLING & INSTALLATION

### Installation (Continued)

- The case or housing and upper electrode should have a space of about 0.5 mm to accommodate expansion or shrinkage due to temperature variances. If a shock barrier is used, do not press hard on the upper electrode area. Any shock barrier should be installed more than 0.6 mm away from A.

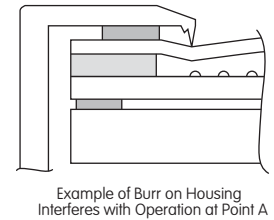
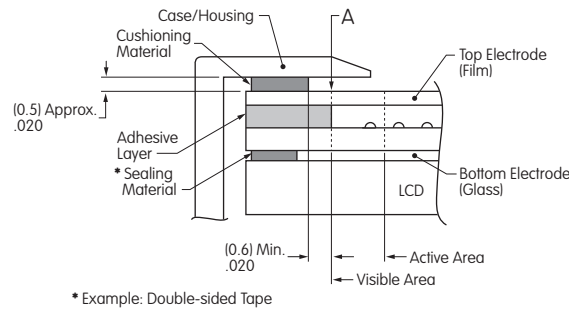

- To secure the touch screen, secure the lower portion with a device such as the LCD display panel. Do not attach the upper electrode with double-sided tape or similar product to avoid stress that can damage the upper or lower electrode.
- In order to balance upper and lower pressure, an air vent may be installed. Ensure that no liquid or oil will enter into the device.
- Avoid air pressure applied to the touch screen as it may cause the top electrode to force air through the air vent, effecting electric endurance. If pressure inside of the touch panel is reduced through the air vent, it may cause interference fringes or may remain in ON status.
- Ensure that the glass is handled carefully to prevent breakage during installation.
- Moisture from condensation on tail connection or edges may result in migration, causing short circuit failure.

### Handling Precautions

- When opening product, take precaution with up/down and front/back directions. Glass edges are not chamfered, and corners or edges can be sharp. Wear gloves when handling the product.
- Do not pick up the product by the tail or pull the tail area.
- Use gloves or finger cots to prevent fingerprints on surface.
- When handling the product, hold it outside of the viewing area.
- Avoid stacking multiple products or placing other items on the product.
- Remove protective film after installation is completed.
- When packing or storing, the glass should be positioned face up.

### Operating Precautions

- Operate with fingers or a touch screen stylus only.
- Do not press hard with a pen or similar object between viewing area and key area.

### Design Precautions

- With analog type, resistive value change (by aging or individual differences) can dislocate the input area. Input area can be calibrated with software.
- When installing on top of an LCD, noise from the display device can create misoperation. To avoid noise, implement actions such as grounding the display device frame.
- When used to draw a line, analog type will have a break at dot spacer. Compensate for this with software.
- Contact resistance may cause chatter depending on pressing condition. Software should detect signal after it stabilizes.

### Other Precautions

- Clean with a soft cloth and ethanol. Do not use any cleaning agents other than ethanol.
- Store product in original package and store at the temperature and humidity range specified.
- Do not store in an environment with acids or other corrosive gases or where condensation may occur.
- Products are guaranteed based on evaluation of standards within the moisture tolerance and usage temperature range, but not guaranteed to operate perpetually at this temperature.
- Calibration data from one touch panel should not be applied to another panel; each should be calibrated individually.
- Recalibration is necessary if connector has been removed from the tail and reconnected.
- All specifications based on the tested touch screens only. Evaluate the products after installation with customer's equipment.

***NKK Meets Demands of the Marketplace & Readily Offers Solutions & Expertise, Integrating the Highest Caliber of Products & Enhancing our Extensive Line of Touch Screens***

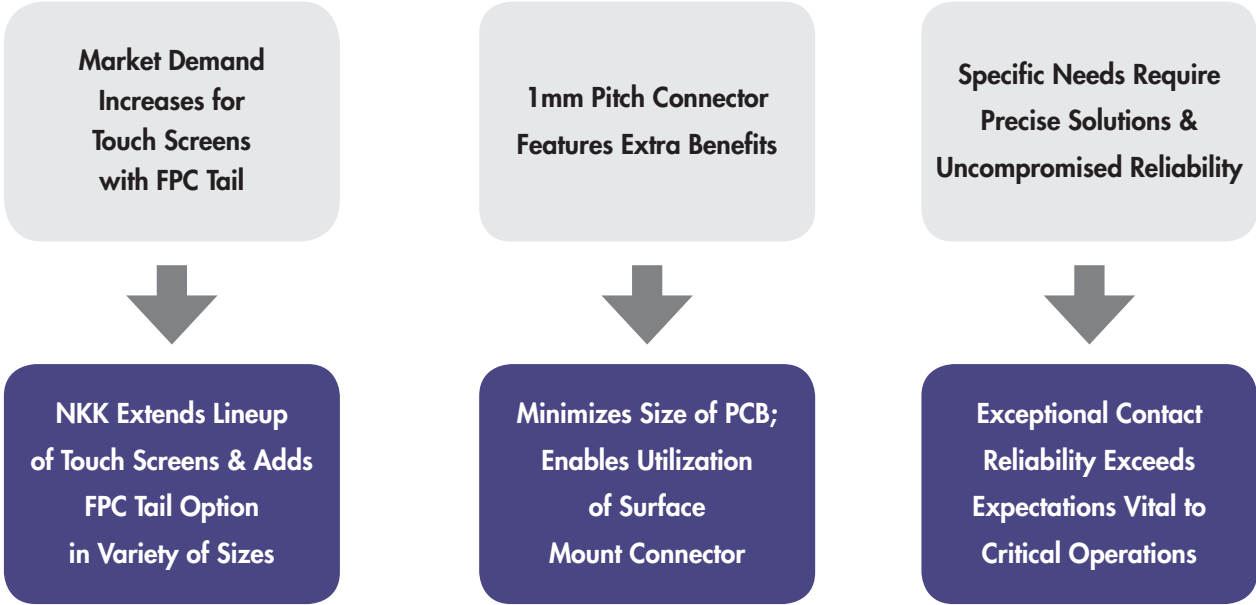

|        |                             | Standard Size <input type="radio"/> |                                  |                       |                                  | New Standard Size <input checked="" type="radio"/> |                                  |                       |                                  |                       |                                  | Custom Size <input type="radio"/> |                                  |                       |                                  |                                  |                       |                       |                       |                                  |
|--------|-----------------------------|-------------------------------------|----------------------------------|-----------------------|----------------------------------|----------------------------------------------------|----------------------------------|-----------------------|----------------------------------|-----------------------|----------------------------------|-----------------------------------|----------------------------------|-----------------------|----------------------------------|----------------------------------|-----------------------|-----------------------|-----------------------|----------------------------------|
| Series | Type                        | Sizes of Touch Screens in Inches    |                                  |                       |                                  |                                                    |                                  |                       |                                  |                       |                                  |                                   |                                  |                       |                                  |                                  |                       |                       |                       |                                  |
|        |                             | 3.5                                 | 5.7                              | 6.2 Wide              | 6.5                              | 7.0 Wide                                           | 8.4                              | 8.5 Wide              | 10.4                             | 10.5                  | 10.6 Wide                        | 12.1                              | 12.1 Wide                        | 14.0                  | 15.0                             | 15.6 Wide                        | 17.0                  | 17.1                  | 18.1                  | 19.0                             |
| FT     | Digital                     | <input type="radio"/>               | <input checked="" type="radio"/> | <input type="radio"/> | <input type="radio"/>            | <input type="radio"/>                              | <input type="radio"/>            | <input type="radio"/> | <input type="radio"/>            | <input type="radio"/> | <input type="radio"/>            | <input type="radio"/>             | <input type="radio"/>            | <input type="radio"/> | <input type="radio"/>            | <input type="radio"/>            | <input type="radio"/> | <input type="radio"/> | <input type="radio"/> | <input type="radio"/>            |
|        | 4-Wire Analog, Printed Tail | <input type="radio"/>               | <input checked="" type="radio"/> | <input type="radio"/> | <input checked="" type="radio"/> | <input type="radio"/>                              | <input checked="" type="radio"/> | <input type="radio"/> | <input checked="" type="radio"/> | <input type="radio"/> | <input checked="" type="radio"/> | <input checked="" type="radio"/>  | <input checked="" type="radio"/> | <input type="radio"/> | <input checked="" type="radio"/> | <input checked="" type="radio"/> | <input type="radio"/> | <input type="radio"/> | <input type="radio"/> | <input checked="" type="radio"/> |
|        | 4-Wire Analog, FPC Tail     | <input type="radio"/>               | <input checked="" type="radio"/> | <input type="radio"/> | <input checked="" type="radio"/> | <input type="radio"/>                              | <input checked="" type="radio"/> | <input type="radio"/> | <input checked="" type="radio"/> | <input type="radio"/> | <input checked="" type="radio"/> | <input checked="" type="radio"/>  | <input checked="" type="radio"/> | <input type="radio"/> | <input checked="" type="radio"/> | <input checked="" type="radio"/> | <input type="radio"/> | <input type="radio"/> | <input type="radio"/> | <input checked="" type="radio"/> |
|        | 5-Wire Analog, Printed Tail |                                     |                                  |                       |                                  |                                                    |                                  |                       | <input checked="" type="radio"/> |                       |                                  | <input checked="" type="radio"/>  |                                  |                       | <input checked="" type="radio"/> |                                  |                       |                       |                       |                                  |
|        | 8-Wire Analog, Printed Tale | <input type="radio"/>               | <input type="radio"/>            | <input type="radio"/> | <input type="radio"/>            | <input type="radio"/>                              | <input type="radio"/>            | <input type="radio"/> | <input type="radio"/>            | <input type="radio"/> | <input type="radio"/>            | <input type="radio"/>             | <input type="radio"/>            | <input type="radio"/> | <input type="radio"/>            | <input type="radio"/>            | <input type="radio"/> | <input type="radio"/> | <input type="radio"/> | <input type="radio"/>            |
| TP01   | 4-Wire Analog, FPC Tail     | <input type="radio"/>               | <input type="radio"/>            | <input type="radio"/> | <input type="radio"/>            | <input type="radio"/>                              | <input type="radio"/>            | <input type="radio"/> | <input checked="" type="radio"/> | <input type="radio"/> | <input checked="" type="radio"/> | <input checked="" type="radio"/>  | <input checked="" type="radio"/> | <input type="radio"/> | <input checked="" type="radio"/> | <input checked="" type="radio"/> | <input type="radio"/> | <input type="radio"/> | <input type="radio"/> | <input checked="" type="radio"/> |

Note: NKK Switches does not supply the IC for 8-wire touch screens.

NKK Switches feature a wide variety of standard touch screens. We also have the capability and expertise to offer custom solutions that would enhance any application. We can furnish designs in both digital (matrix) and analog type touch screens; custom sizes and key numbers; attachment of touch screen to LCDs or incorporation into peripheral devices; availability of film plus film combinations and fingerprint resistant, high transmittance films. Contact our experts and let us provide a resolution for all of your touch screen requirements.

## NKK Expands Offering of Touch Screen Solutions with Variety of Functions

**Multi-Touch, Smooth Operation**  
TP01 Series 4-Wire Analog



**4.3 Narrow**  
10.4" 12.1" 15.0" 19.0"

**16.9 Wide**  
10.6" 12.1" 15.6"

**Zoom In, Zoom Out or Writing Functions**  
TP01 Series 4-Wire Analog

**4.3 Narrow**  
10.4" 12.1" 15.0" 19.0"

**16.9 Wide**  
10.6" 12.1" 15.6"



Controller Board  IC Chip 

**Touch Screen Without IC Chip**  
FT Series Digital

5.7"

**Superior Durability**  
FT Series Analog 5- or 8-Wire Analog

**4.3 Narrow**  
10.4" 12.1" 15.0"



Controller Board  IC Chip 

**Variety of Sizes**  
FT Series 4-Wire Analog with Printed Tail

**4.3 Narrow**  
5.7" 6.5" 8.4" 10.4" 12.1"

15.0" 19.0"

**16.9 Wide**  
10.6" 12.1" 15.6"



Controller Board  IC Chip 

**Exceptional Reliability**  
FT Series 4-Wire Analog with FPC Tail

**4.3 Narrow**  
5.7" 6.5" 8.4" 10.4" 10.4"

12.1" 15.0" 19.0"

**16.9 Wide**  
10.6" 12.1" 15.6"

Controller Board  IC Chip 

**Effective Date** October 23, 2017



http://www.nkkswitches.com • 1.877.2BUYNKK (228.9655)  
7850 East Gelding Drive • Scottsdale, AZ 85260 • Telephone 480.991.0942 • Fax 480.998.1435

## X-ON Electronics

Largest Supplier of Electrical and Electronic Components

*Click to view similar products for [LCD Touch Panels](#) category:*

*Click to view products by [NKK Switches](#) manufacturer:*

Other Similar products are found below :

[98-0003-2669-8](#) [CABLE/RTP/USB](#) [98-0003-2933-8](#) [17-8041-226](#) [17-8041-227](#) [CABLE/RTP/RS232](#) [N010-0557-T002](#) [N010-0557-T011](#)  
[LCDAL04-0430TL0NCNTBR1.0](#) [TP01106W-4KB](#) [FTAS00-15AN-4](#) [FTAS00-12.1AW-4A](#) [17-8021-227](#) [17-8031-205](#) [17-8031-227](#) [17-](#)  
[8091-203](#) [17-8421-205](#) [17-8421-227](#) [17-8441-205](#) [17-8511-205](#) [17-8541-205](#) [17-8541-226](#) [17-8891-227](#) [17-8901-226](#) [98-0003-2185-5](#) [98-](#)  
[0003-2617-7](#) [98-0003-2919-7](#) [98-0003-2955-1](#) [98-0003-3140-9](#) [98-0003-3155-7](#) [98-0003-3190-4](#) [98-0003-3505-3](#) [98-1100-0606-5](#) [98-1100-](#)  
[0638-8](#) [EA TOUCH240-4](#) [N010-0519-T742](#) [N010-0554-T043](#) [N010-0554-T703](#) [EA TOUCH102-1](#) [EA TOUCH128-1](#) [EA TOUCH128-2](#)  
[EA TOUCH160-1](#) [LCD-OLINUXINO-10CTS](#) [TS-320240BRNO](#) [TS-TFT3.5Z](#) [FTAS00-104A5](#) [FTAS00-104AS4](#) [FTAS00-104AV4](#)  
[FTAS00-121A4](#) [FTAS00-121A5](#)