

General Specifications

Electrical Capacity (Resistive Load)

Power Level (silver): 1A @ 125/250V AC or 1A @ 30V DC
Logic Level (gold): 0.4VA maximum @ 28V AC/DC maximum (Applicable Range 0.1mA ~ 0.1A @ 20mV ~ 28V)
 Note: Find additional explanation of operating range in Supplement section.

Other Ratings

Contact Resistance: 50 milliohms maximum
Insulation Resistance: 1,000 megohms minimum @ 500V DC
Dielectric Strength: For Silver: 1,000V AC minimum between contacts for 1 minute minimum & 1,500V AC minimum between contacts & case for 1 minute minimum;
 For Gold: 750V AC minimum between contacts for 1 minute minimum & 1,500V AC minimum between contacts & case for 1 minute minimum
Mechanical Life: 100,000 operations minimum
Electrical Life: 50,000 operations minimum for silver; 100,000 operations minimum for gold
Nominal Operating Force: Single pole 0.98 ~ 2.45N for maintained & 0.98 ~ 1.96N for momentary;
 Double pole 1.47 ~ 3.43N for maintained & 1.47 ~ 2.94N for momentary
Contact Timing: Nonshorting (break-before-make)
Travel: Pretravel .087" (2.2mm); Overtravel .031" (0.8mm); Total Travel .118" (3.0mm)

Materials & Finishes

Housing: Polyamide (UL94V-0)
Movable Contactor: Silver for power circuit; copper with gold plating for logic level circuit
Stationary Contacts: Silver for power circuit; copper with gold plating for logic level circuit
Housing Base: Polyamide (UL94V-0)
Terminal Base: Polyester
Common Terminals: Phosphor bronze with silver flash plating for power circuit;
 Phosphor bronze with gold flash plating for logic level circuit
End Terminals: Brass with silver flash plating for power circuit;
 Brass with gold flash plating for logic level circuit
Lamp Terminals: Phosphor bronze with nickel flash plating

Environmental Data

Operating Temperature Range: -25°C through +50°C (-13°F through +122°F) for Illuminated
 -25°C through +70°C (-13°F through +158°F) for Nonilluminated
Humidity: 90 ~ 95% humidity for 96 hours @ 40°C (104°F)
Vibration: 10 ~ 55Hz with peak-to-peak amplitude of 1.5mm traversing the frequency range & returning in 1 minute; 3 right angled directions for 2 hours
Shock: 50G (490m/s²) acceleration (tested in 6 right angled directions, with 3 shocks in each direction)

Installation

Mounting Torque: 0.78Nm (6.9 lb•in) maximum
Cap Installation Force: 4.51N (1.0 lbf) maximum downward force on cap
Soldering Time & Temperature: Manual Soldering: See Profile A in Supplement section.

Standards & Certifications

Flammability Standards: UL94V-0 housing & housing base
UL: **File No. E44145 - Recognized only when ordered with marking on switch.**
 Add "/U" or "/CUL" before first dash in part number to order UL recognized switch.
 Single & double pole models recognized at 1A @ 125/250V AC, 1A @ 30V DC, & 0.4VA @ 28V DC.
CSA: **File No. 023535_0_000 - Certified only when ordered with marking on switch.**
 Add "/C" before first dash in part number to order CSA certified switch.
 Single & double pole models recognized at 1A @ 125/250V AC, 1A @ 30V DC, & 0.4VA @ 28V DC.

Distinctive Characteristics

Bright illumination with numerous color variations. Spot illumination available. Square, rectangular, and round shaped caps.

Front panel relamping.

Choice of bright or super bright LEDs in red, amber, green, white, and blue.

Latchdown feature gives indication of circuit status. Audible and tactile feedback with smooth and responsive operation.

Snap-action mechanism for long life.

Stainless steel frame on snap-in models has a specially designed projection, which prevents rotation and correctly orients switch in panel.

12mm body diameter.

Molded-in terminals lock out flux, dust, and other contaminants.

8mm panel thickness capability. Rear panel bushing or snap-in mounting.

Optional PCB adaptors in straight and right angle types.

Matching indicators available.



Actual Size



- Toggles
- Rockers
- Pushbuttons
- Illuminated PB**
- Programmable
- Keylocks
- Rotaries
- Slides
- Tactiles
- Tilt
- Touch
- Indicators
- Accessories
- Supplement

TYPICAL SWITCH

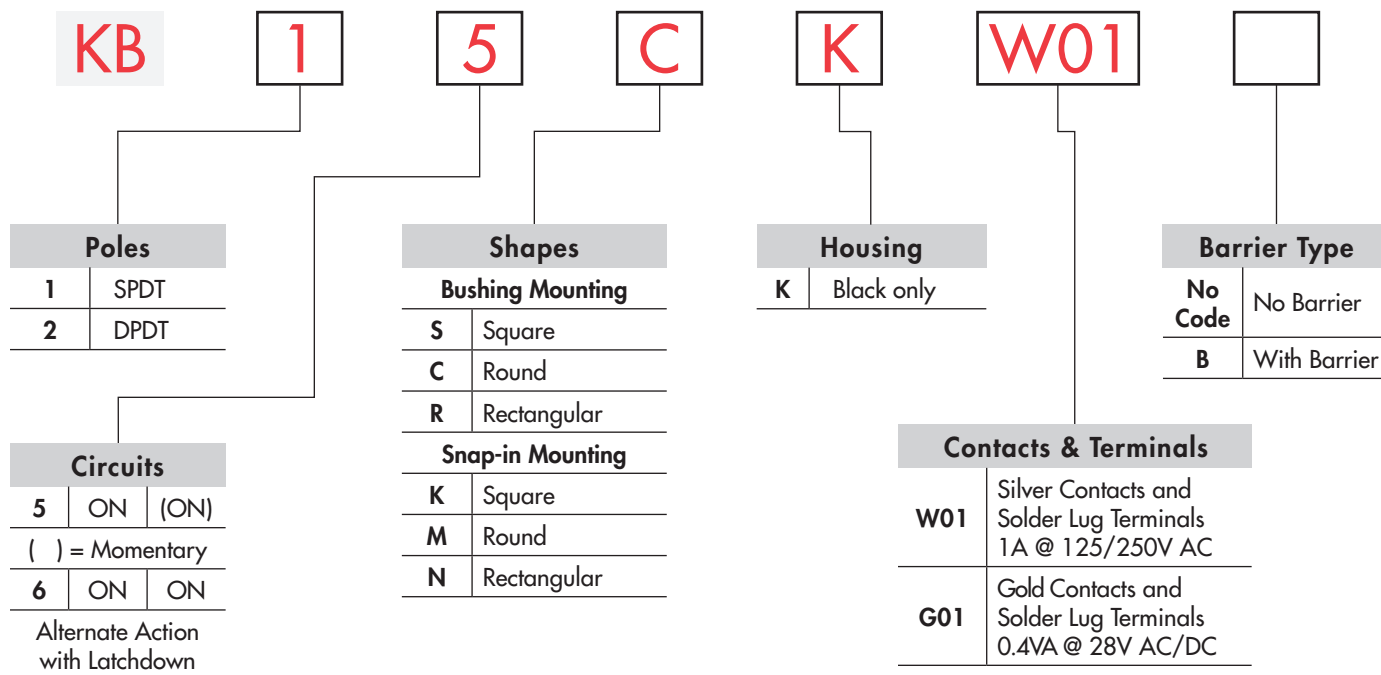

IMPORTANT:



Switches are supplied without UL, cULus & CSA marking unless specified.
UL, cULus & CSA recognized only when ordered with marking on the switch.
 Specific models, ratings, & ordering instructions are noted on the General Specifications page.

DESCRIPTION FOR TYPICAL ORDERING EXAMPLE

KB15CKW01-12-FF



ORDERING EXAMPLE



Toggle

Rockers

Pushbuttons

Illuminated PB

Programmable

Keylocks

Rotaries

Slides

Tactiles

Tilt





Touch

Indicators

Accessories

Supplement

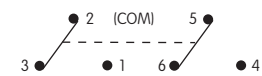
POLES & CIRCUITS

Pole	Model	Plunger Position () = Momentary		Connected Terminals		Throw & Switch/Lamp Schematics
		Normal	Down	Normal	Down	
SP	KB15 *KB16	ON ON	(ON) ON	2-3	2-1	Notes: Switch is marked with "+" and "-". Lamp circuit is isolated and requires external power source. SPDT  
DP	KB25 *KB26	ON ON	(ON) ON	2-3 5-6	2-1 5-4	DPDT  

* When in latchdown position for the alternate circuit, cap position is .055" (1.4mm) above the built-in bezel.

MOUNTING TYPES & SHAPES

Bushing Mounting

S .551" (14.0mm)
Square



No barrier



With barrier

C .551" (14.0mm)
Round

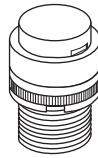

R .551" x .728" (14.0mm x 18.5mm)
Rectangular



No barrier

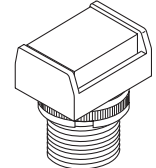

With barrier

Bezel or barrier is an integral part of the switch body. One mounting nut AT057 supplied with each switch.

Snap-in Mounting

K .551" (14.0mm)
Square



No barrier



With barrier

M .551" (14.0mm)
Round

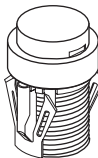

N .551" x .728" (14.0mm x 18.5mm)
Rectangular



No barrier

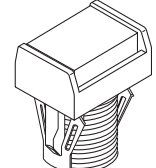

With barrier

Bezel or barrier is an integral part of the switch body.

Panel Cutouts

Bushing Mounting

Without Keyway



Panel Thickness:
.020" ~ .315"
(0.5 ~ 8.0mm)



With Keyway

Snap-in Mounting

Panel Thickness:
.039" ~ .138"
(1.0 ~ 3.5mm)



Panel thicknesses, when using optional accessories, are shown with the accessories at the end of this KB section.

HOUSING

K Housing available in black only. Bezel or barrier is an integral part of the switch body.

CONTACT MATERIALS, RATINGS & TERMINALS

W Silver Contacts

Power Level
1A @ 125V AC & 250V AC

01 Solder Lug



G Gold Contacts

Logic Level
0.4VA maximum @ 28V AC/DC

Complete explanation of operating range in Supplement section.

AT055 Crossover Guard

A partitioned plastic guard is supplied with each switch to provide insulation between terminals.

Installation steps:

1. Identify wire-to-terminal connections.
2. Thread wires through the guard.
3. Solder the connections.
4. Push the guard fully onto the switch body.

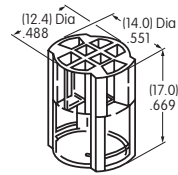

BARRIER TYPE



No Code No Barrier
Built-in bezel

B With Barrier
Built-in barrier only available for Square and Rectangular

LAMP COLORS & SPECIFICATIONS

The electrical specifications shown are determined at a basic temperature of 25°C. LED circuit is isolated and requires external power source. Polarity marks are on the bottom of the switch. If the source voltage exceeds the rated voltage, a ballast resistor is required. The resistor value can be calculated by using the formula in the Supplement section. Ambient Temperature Range for lamps below: -25°C ~ +50°C.

Incandescent & Neon Lamps

		05	12	01			
AT611 Incandescent	AT615 Neon				Recommended Resistors for Neon: 33K ohms for 110V AC; 100K ohms for 220V AC		
		Voltage	V	5V AC		12V AC	110V AC
		Current	I	115mA		60mA	1.5mA
		Endurance	Hours	7,000 average		10,000	

No Code No Lamp

Bright LED with Resistor

AT634	Color Codes:			Resistor Codes		
	Red	Amber	Green			
LEDs are colored in OFF state.	5C	5D	5F	05	12	24
	Maximum Forward Current			I_{FM}	—	—
	Typical Forward Current			I_F	25mA	20mA
	Forward Voltage			V_F	5V	12V
	Maximum Reverse Voltage			V_{RM}	4V	8V
	Current Reduction Rate Above 25°C			ΔI_F	—	—

AT634
5-volt
2-element
with 1 Resistor

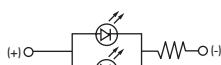

AT634
12-volt
4-element
with 2 Resistors

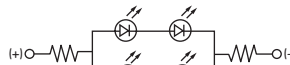

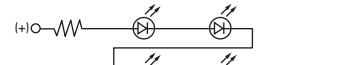

AT634
24-volt
4-element
with 2 Resistors





LAMP COLORS & SPECIFICATIONS

Bright LED without Resistor

AT635 LEDs are colored in OFF state.   T-1½ Bi-pin	Color Codes	Red 5C	Amber 5D	Green 5F	No Code No Resistor
	Maximum Forward Current	I_{FM}			30mA
	Typical Forward Current	I_F			20mA
	Forward Voltage	V_F			1.9V
	Maximum Reverse Voltage	V_{RM}			5V
	Current Reduction Rate Above 25°C	ΔI_F			0.42mA/°C
	Ambient Temperature Range	-25° ~ +50°C			

Super Bright Single Element LED

AT625G Blue AT631B White AT632F Green   T-1 Bi-pin	 ATTENTION ELECTROSTATIC SENSITIVE DEVICES			Color	6B	6F	6G
	Maximum Forward Current	I_{FM}			White	Green	Blue
	Typical Forward Current	I_F			30mA	30mA	30mA
	Forward Voltage	V_F			20mA	20mA	20mA
	Maximum Reverse Voltage	V_{RM}			3.3V	3.3V	3.3V
	Current Reduction Rate Above 25°C	ΔI_F			7V	7V	7V
	Ambient Temperature Range				0.40mA/°C	0.40mA/°C	0.40mA/°C
					-25° ~ +50°C		

CAP TYPES & COLOR COMBINATIONS

Color Codes: **A** Black **B** White **C** Red **E** Yellow **F** Green **G** Blue **J** Clear

Solid Cap for Incandescent Lamp & Nonilluminated

Lens/Filter Colors Available:

- A** Nonilluminated Only; Square & Round Only
- BB** **FB**
- CB** **FF**
- CC** **GB**
- EB** **GG**

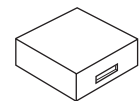
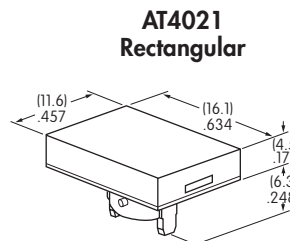
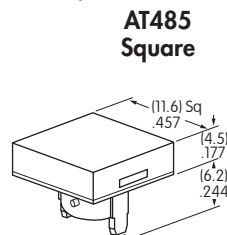

Translucent Colored Lens

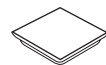

Translucent Colored Filter



Lamp AT611

Material: Polycarbonate Finish: Glossy

Insert Cap for Incandescent or Neon Lamp & Nonilluminated

Lens/Filter Colors Available:

- JB** **JF**
- JC** **JG**
- JE**

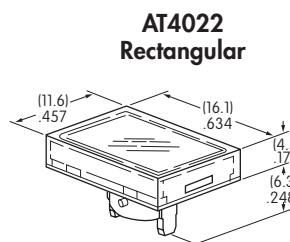
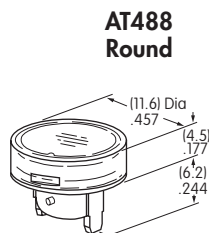
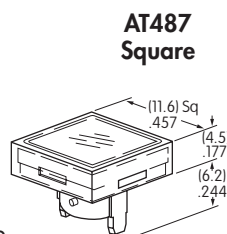

Transparent Clear Lens



Translucent Colored Filter



Lamp AT611 Lamp AT615

JF and JG not suitable with neon lamp.

Material: Polycarbonate Finish: Glossy

CAP TYPES & COLOR COMBINATIONS

Color Codes: A Black B White C Red D Amber E Yellow F Green G Blue J Clear

Spot Illuminated Cap for Bright LED without Resistor or with Resistor

Cap/Window Colors Available:

AB

Opaque Black Cap with Translucent White Window for Spot Illumination

AT4051
Square

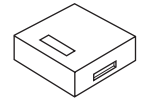
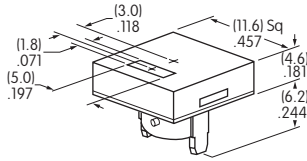

Bright LED
AT635

Bright LED
AT634

Material: Polycarbonate Finish: Matte

Cap for Bright LED without Resistor or LED with Resistor

Lens/Diffuser Colors Available: (AT4133, 4132, 4134 white diffusers; AT4158, 4160, 4159 colored diffusers)

JB

AT4133

AT4132

AT4134

Square

Round

Rectangular

Transparent Clear Lens



JC

AT4158

AT4160

AT4159

Translucent Diffuser



JD

JF

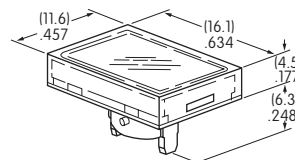
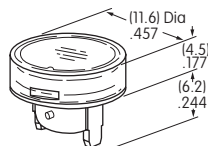
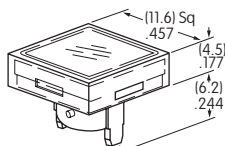

Bright LED
AT635

Bright LED
AT634

Material: Polycarbonate Finish: Glossy

Cap for Super Bright LED

Lens/Diffuser Colors Available:

JB

AT4133
Square

AT4132
Round

AT4134
Rectangular

Translucent Clear Lens

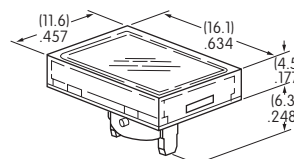
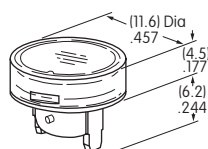
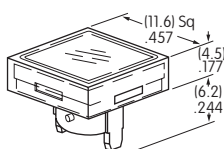

Translucent White Diffuser

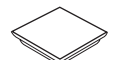

Super Bright LEDs
AT625
AT631 AT632

Material: Polycarbonate Finish: Glossy

TYPICAL SWITCH DIMENSIONS

Square • Bushing Mount

Single & Double Pole

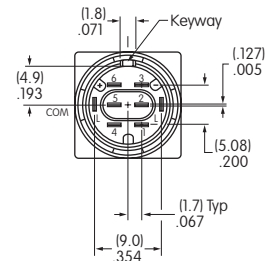
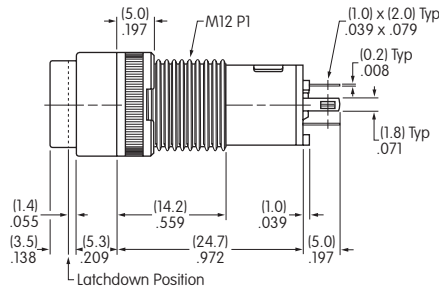

KB15SKW01-05-GG

Single pole models do not have terminals 4, 5, & 6.

Round • Bushing Mount

Single & Double Pole

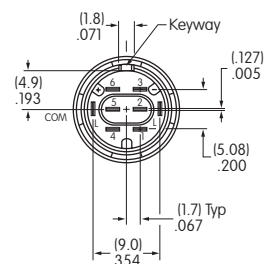
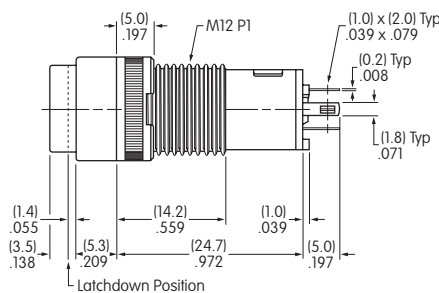
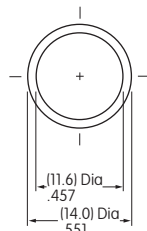

KB25CKW01-05-GG

Single pole models do not have terminals 4, 5, & 6.

Rectangular • Bushing Mount

Single & Double Pole

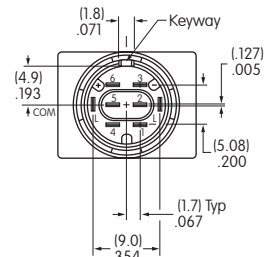
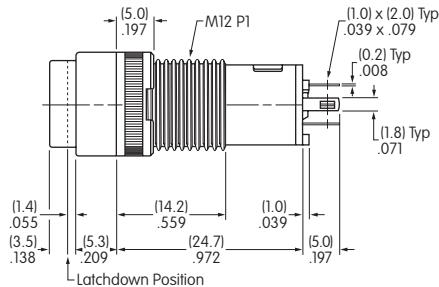
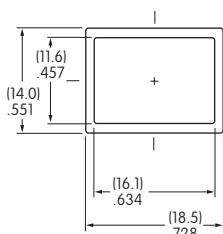

KB15RKW01-05-GG

Single pole models do not have terminals 4, 5, & 6.

TYPICAL SWITCH DIMENSIONS

Single & Double Pole

Square • Snap-in Mount

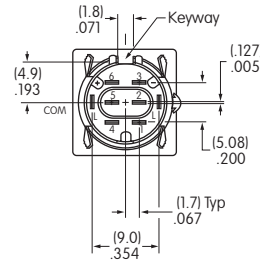
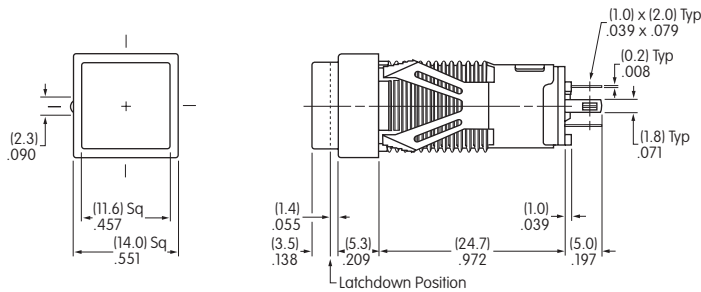

Single pole models do not have terminals 4, 5, & 6.

KB16KKW01-05-CB

Single & Double Pole

Round • Snap-in Mount

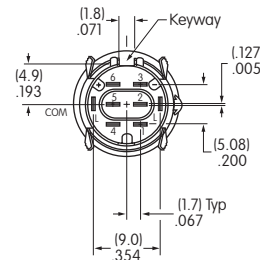
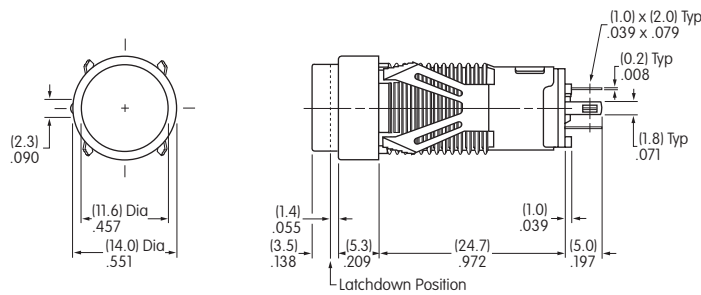

Single pole models do not have terminals 4, 5, & 6.

KB26MKW01-05-CB

Single & Double Pole

Rectangular • Snap-in Mount

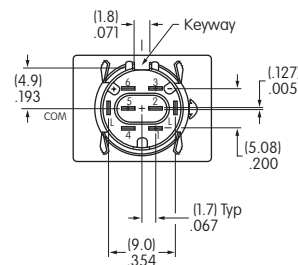
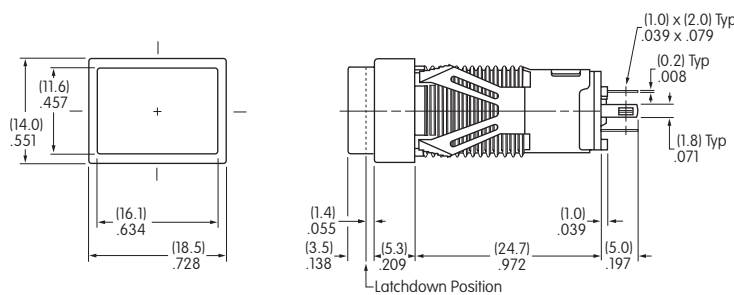

Single pole models do not have terminals 4, 5, & 6.

KB16NKW01-05-CB

TYPICAL SWITCH DIMENSIONS

Square • Barrier • Bushing Mount

Single & Double Pole

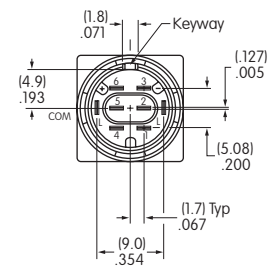
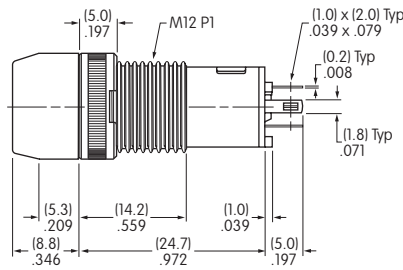
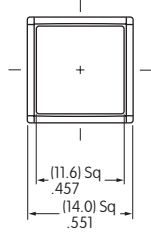

KB15SKW01B-6G-JB

Single pole models do not have terminals 4, 5, & 6.

Square • Barrier • Snap-in Mount

Single & Double Pole

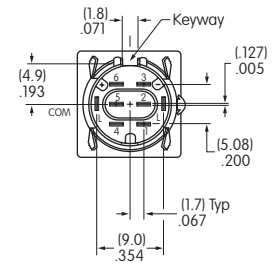
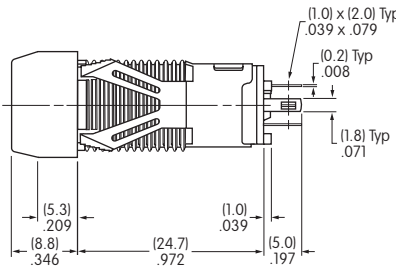
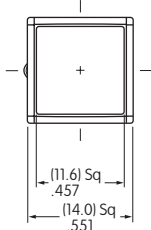

KB15KKW01B-5C-JC

Single pole models do not have terminals 4, 5, & 6.

Rectangular • Barrier • Bushing Mount

Single & Double Pole

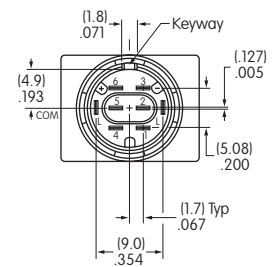
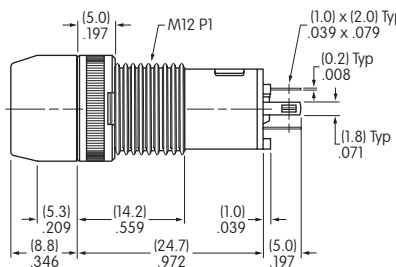
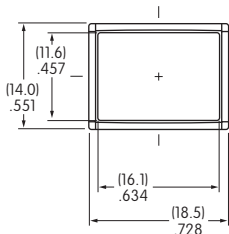

KB15RKW01B-5F-JF

Single pole models do not have terminals 4, 5, & 6.

Rectangular • Barrier • Snap-in Mount

Single & Double Pole

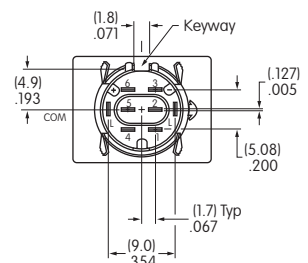
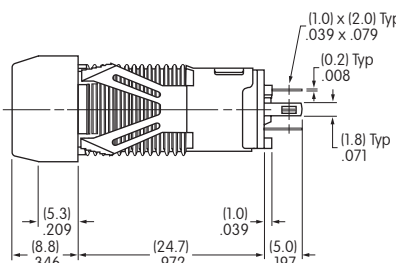
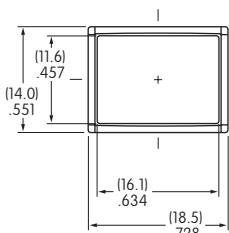

KB15NKW01B-5D-JD

Single pole models do not have terminals 4, 5, & 6.

OPTIONAL ACCESSORIES

PCB Adaptors

AT701
Single Pole
Straight PC
Terminals



AT702
Double Pole
Straight PC
Terminals

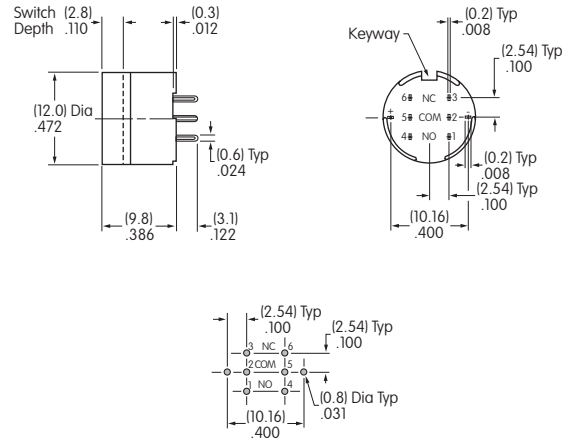
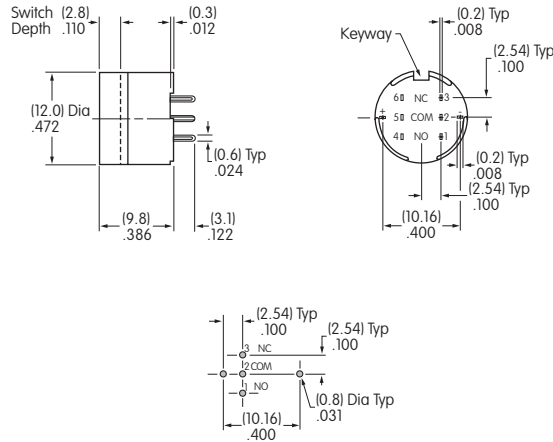

Material: Glass fiber reinforced polyamide Note: Order adaptors separately

Dust Covers

Panel Thickness Range: .020 ~ .268" (0.5 ~ 6.8mm) for Bushing Mounting; .020 ~ .079" (0.5 ~ 2.0mm) for Snap-in Mounting
Dust Covers reduce the depth of switch behind panel by .047" (1.2mm).

AT495
For Square & Round
(not for Barrier type)

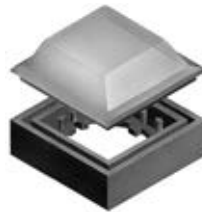

AT4025
For Rectangular
(not for Barrier type)

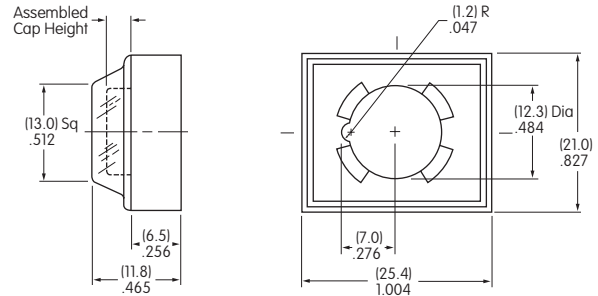
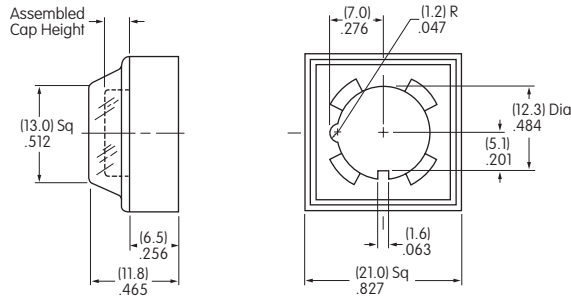

Material: Lid: PVC PVC loses pliability below 0°C (32°F). Base: Polyamide

Toggles
Rockers
Pushbuttons
Illuminated PB
Programmable
Keylocks
Rotaries
Slides
Tactiles
Tilt
Touch
Indicators
Accessories
Supplement

OPTIONAL ACCESSORIES

Protective Guards

AT494
For Square & Round
(not for Barrier type)



AT4024
For Rectangular
(not for Barrier type)



Panel Thickness
Range:
.020" ~ .268"
(0.5 ~ 6.8mm)
for Bushing Mounting

.020" ~ .091"
(0.5 ~ 2.3mm)
for Snap-in Mounting

Protective Guards reduce
the depth of switch
behind panel by
.047" (1.2mm).

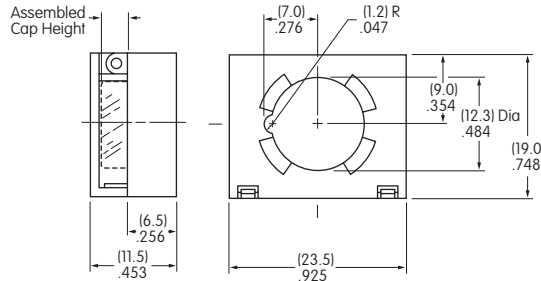
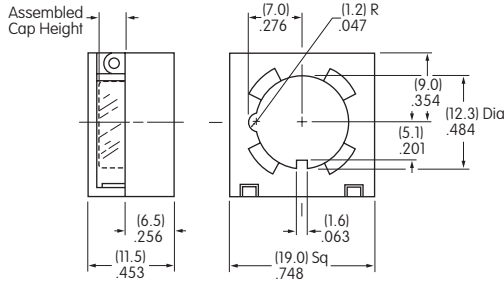

Material: Cover: Polycarbonate

Base: Polyamide

ASSEMBLY INSTRUCTIONS

Cap Removal & Installation

For alternate action models cap must be in UP position for cap removal. Indentations on opposite sides of the cap provide an easy way to lift the cap out of the holder, using either the finger nails, or cap extractor AT109.

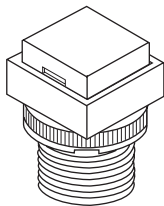

LED Polarity & Orientation in Lamp Socket

Super Bright LEDs AT625, AT631, & AT632 are electrostatic sensitive.



LED
AT635



LED
AT634



LEDs
AT625
AT631
AT632

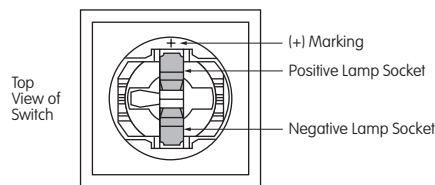
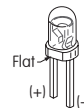

Cap Replacement

Note that the cap has a pair of round tabs and a pair of long tabs which should be used for correctly replacing the cap in its holder. Using the long tabs as guides, slide the cap with the long tabs moving into the slots on opposite sides of the cap holder. Then, the round tabs will snap into notches on the other two sides of the holder.

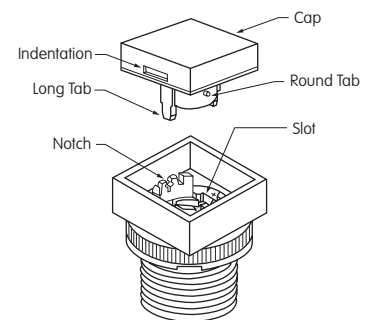

AT108 Socket Wrench for Bushing Mounting

Overtightening the mounting nut may damage the switch housing.



AT109 Cap Extractor



AT111 Lamping Tool

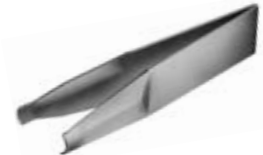

LEGENDS

NKK Switches can provide custom legends for caps. Contact factory for more information.

Suggested Printable Area for KB Lens

Recommended Methods: Screen Print or Pad Print on Lens.
Epoxy based ink is recommended.

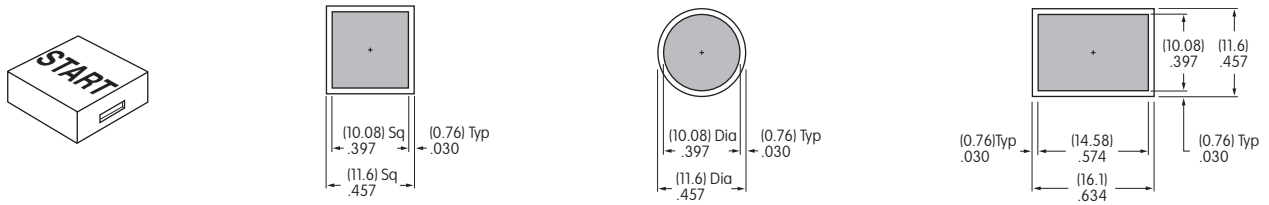

Shaded areas are printable areas.

Suggested Printable Area for Film Insert

Recommended Print Method: Laser Print

Film Insert: Clear Polyester, 4 mil max. thickness

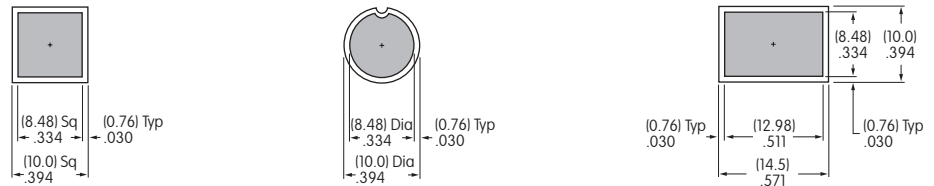
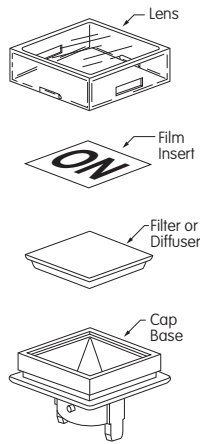

Shaded areas are printable areas.

X-ON Electronics

Largest Supplier of Electrical and Electronic Components

Click to view similar products for [Pushbutton Switches](#) category:

Click to view products by [NKK Switches](#) manufacturer:

Other Similar products are found below :

[8940K2012](#) [LW1L-M1C10V-A](#) [LW1L-M1C70-A](#) [LW2L-A1C20M-GD](#) [LW2L-M1C20M-A](#) [60324L](#) [M22-D-R-GB0/K11](#) [M7E-HRN2](#)
[67021K512](#) [67081K512X](#) [701PB580](#) [7199K101](#) [810K12910](#) [810KSV30B](#) [MML21EA2ADK](#) [MML21KA3ABK](#) [MML23KA3AC05K-001](#)
[MML23KW3AA01W](#) [8418K2](#) [8442K3](#) [8450K1](#) [860K11911T01A](#) [861901](#) [861K11911T01A07](#) [861K13810T00A14](#) [861K13911](#)
[8646AB6X718UL](#) [8646ABUL](#) [9001KXRK](#) [907AYY100](#) [PMHD155A1](#) [9533CD4+U574+U4922](#) [95-414.000](#) [99-450.837](#) [99-453.837](#)
[PV3H2B0NN-341](#) [1203MRA](#) [A22NZBGANGA](#) [A22NZBMMNGA](#) [A22NZBNANGA](#) [A22NZMPATRA](#) [A2PMA1X03EC56](#) [A3A-5123-02](#)
[A3A-7140](#) [A3A-7310](#) [A3A-7340](#) [A3U-TMW-A2C-5M](#) [A595](#) [12037A2ULCSA](#) [ABD122N-B](#)