

TYPICAL INDICATOR ORDERING EXAMPLE

LB 01 G W01 — 5C 12 — JC

Shapes

| | |
|----|-------------|
| 01 | Square |
| 02 | Round |
| 03 | Rectangular |

Housing

| | |
|---|-------|
| K | Black |
| G | Gray |

Terminals

| | |
|-----|--|
| W01 | Silver Solder Lug/ Quick Connect Terminals |
|-----|--|

Lamps

Incandescent Lamp Used with Solid Cap

| | |
|----|---------|
| 05 | 5-volt |
| 12 | 12-volt |

Incandescent or Neon Used with Insert Cap

| | |
|----|----------------------|
| 01 | 110-volt Neon |
| 05 | 5-volt Incandescent |
| 12 | 12-volt Incandescent |

Bright LED Used with LED Cap

| Colors | | Resistor | |
|--------|-------|----------|-------------|
| 5C | Red | No Code | No Resistor |
| 5D | Amber | 05 | 5-volt |
| 5F | Green | 12 | 12-volt |
| | | 24 | 24-volt |

Super Bright LED Used with LED Cap

| | |
|----|-------|
| 6B | White |
| 6F | Green |
| 6G | Blue |

Cap Types & Colors

Solid Cap: Lens/Filter Colors

| | |
|----|--------------|
| BJ | White/Clear |
| CJ | Red/Clear |
| EJ | Yellow/Clear |
| FJ | Green/Clear |
| GJ | Blue/Clear |

Insert Cap: Lens/Filter Colors

| | |
|-----|--------------|
| JB | Clear/White |
| JC | Clear/Red |
| JE | Clear/Yellow |
| *JF | Clear/Green |
| *JG | Clear/Blue |

*JF & JG not suitable with neon.

LED Cap: Lens/Diffuser Colors

| | |
|----|-------------|
| JB | Clear/White |
| JC | Clear/Red |
| JD | Clear/Amber |
| JF | Clear/Green |

LED Cap: Lens/Diffuser Colors

| | |
|----|-------------|
| JB | Clear/White |
|----|-------------|

DESCRIPTION FOR TYPICAL ORDERING EXAMPLE

LB01GW01-5C12-JC



SHAPES & PANEL CUTOUTS

01 .622" (15.8mm)
Square

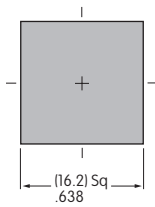
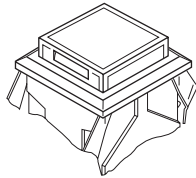

02 .854" (21.7mm)
Round

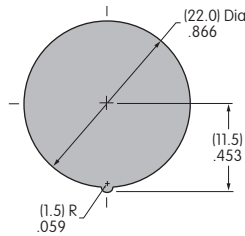
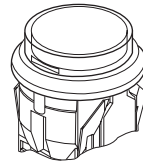

03 .622" x .866" (15.8mm x 22.0mm)
Rectangular

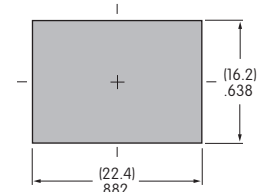
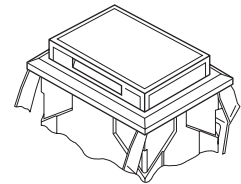

Panel Thickness: .039" ~ .157" (1.0 ~ 4.0mm)

HOUSING

Housing Colors Available:

K Black

G Gray

TERMINALS

W01 Silver Solder Lug/.110" (2.8mm) Quick Connect

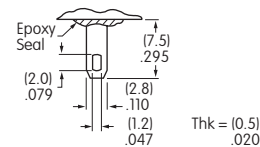

LAMP CODES & SPECIFICATIONS

Incandescent Lamp for Solid Colored and Colored Insert Caps

| | | | | |
|---|---------------------|-----------|----------------|--------|
| AT607  T-1 Bi-pin | | 05 | 12 | |
| | Voltage | V | 5V AC | 12V AC |
| | Current | I | 115mA | 60mA |
| | Endurance | Hours | 10,000 average | |
| | Ambient Temp. Range | | -25°C ~ +50°C | |

Neon Lamp for Colored Insert Cap

| | | | |
|--|---------------------|-----------|----------------|
| AT607N  T-1 Bi-pin | | 01 | |
| | Voltage | V | 110V AC |
| | Current | I | 1.5mA |
| | Endurance | Hours | 10,000 average |
| | Ambient Temp. Range | | -25°C ~ +50°C |
| Recommended Resistors: 33K ohms for 110V AC; 100K ohms for 220V AC | | | |

The electrical specifications shown are determined at a basic temperature of 25°C.

LED COLORS & SPECIFICATIONS

The electrical specifications shown are determined at a basic temperature of 25°C. Polarity marks are on the device.
 If the source voltage exceeds the rated voltage, a ballast resistor is required.
 The resistor value can be calculated by using the formula in the Supplement section.
 Additional lamp detail is shown in the Accessories & Hardware section.

Bright LED without Resistor

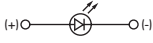
| | | | | | |
|---|-----------------------------------|------------------|--------------------|--------------------|----------------------------|
| AT635 LEDs are colored in OFF state.   T-1½ Bi-pin | Color Codes | Red 5C | Amber 5D | Green 5F | No Code No Resistor |
| | Maximum Forward Current | I_{FM} | | | 30mA |
| | Typical Forward Current | I_F | | | 20mA |
| | Forward Voltage | V_F | | | 1.9V |
| | Maximum Reverse Voltage | V_{RM} | | | 5V |
| | Current Reduction Rate Above 25°C | ΔI_F | | | 0.42mA/°C |
| | Ambient Temperature Range | | | | -25° ~ +50°C |

Bright LED with Resistor

| | | | | | | | |
|---|-----------------------------------|------------------|--------------------|--------------------|----------------|-----------|-----------|
| AT627 with Resistor  T-1 Bi-pin | Color Codes: | Red 5C | Amber 5D | Green 5F | Resistor Codes | | |
| | Maximum Forward Current | I_{FM} | | | 05 | 12 | 24 |
| | Typical Forward Current | I_F | | | 52mA | 26mA | 13mA |
| | Forward Voltage | V_F | | | 5V | 12V | 24V |
| | Maximum Reverse Voltage | V_{RM} | | | 4V | 8V | 16V |
| | Current Reduction Rate Above 25°C | ΔI_F | | | 0.50mA/°C | | |
| | Ambient Temperature Range | | | | -25° ~ +50°C | | |

AT627
5-volt
4-element
with Resistor

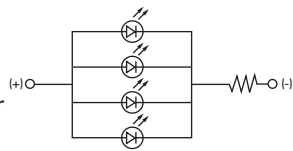

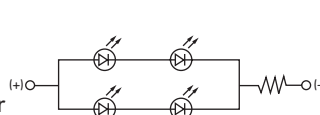

AT627
12-volt
4-element
with Resistor

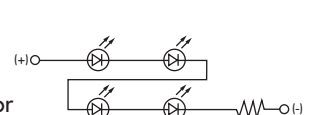

AT627
24-volt
4-element
with Resistor



Super Bright Single Element LED

| | | | | | | | |
|--|---|--------------|-------|-----------|--------------|-----------|-----------|
| AT625G Blue AT631B White AT632F Green   T-1 Bi-pin |  | | | 6B | 6F | 6G | |
| | Color | White | Green | Blue | | | |
| | Maximum Forward Current | I_{FM} | | | 30mA | 30mA | 30mA |
| | Typical Forward Current | I_F | | | 20mA | 20mA | 20mA |
| | Forward Voltage | V_F | | | 3.3V | 3.3V | 3.3V |
| | Maximum Reverse Voltage | V_{RM} | | | 7V | 7V | 7V |
| | Current Reduction Rate Above 25°C | ΔI_F | | | 0.40mA/°C | 0.40mA/°C | 0.40mA/°C |
| | Ambient Temperature Range | | | | -25° ~ +50°C | | |

CAP TYPES & COLOR COMBINATIONS

Color Codes: B White C Red D Amber E Yellow F Green G Blue J Clear

Solid Cap for Incandescent Lamp

Lens/Filter
Colors Available:

- BJ FJ
- CJ GJ
- EJ

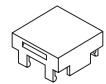
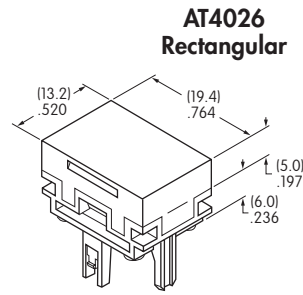
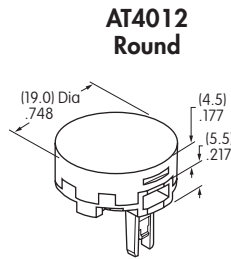
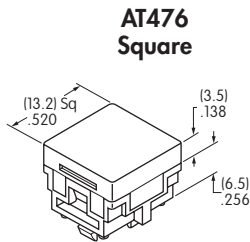

Translucent Colored Lens

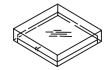

Transparent Clear Filter



Lamp AT607

Material: Polycarbonate Finish: Glossy

Insert Cap for Incandescent or Neon Lamp

Lens/Filter
Colors Available:

- JB JF
- JC JG
- JE

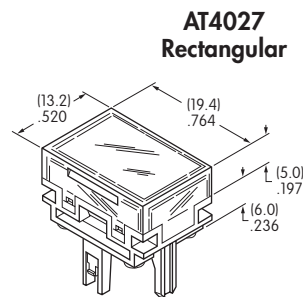
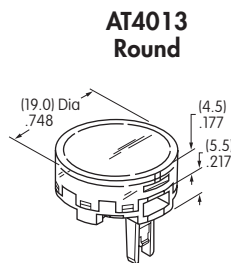
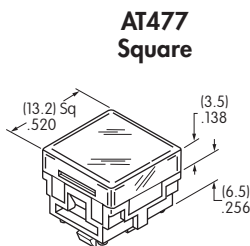

Transparent Clear Lens



Translucent Colored Filter



Lamp AT607 or 607N

Material: Polycarbonate Finish: Glossy

JF and JG not suitable with neon lamp.

Cap for Bright LED without Resistor

Lens/Diffuser
Colors Available:

- JB
- JC
- JD
- JF

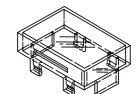
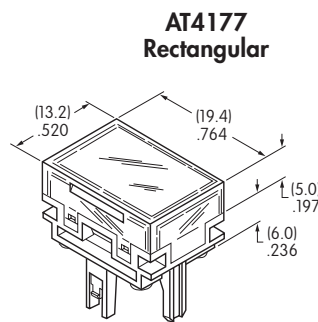
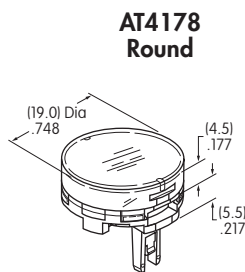
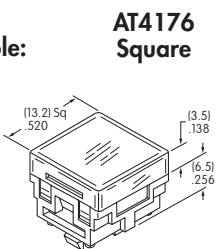

Transparent Clear Lens

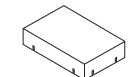

Translucent Colored Diffuser



Bright LED AT635

Material: Polycarbonate Finish: Glossy

Cap for Bright LED with Resistor

Lens/Diffuser
Colors Available:

- JB
- JC
- JD
- JF

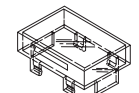
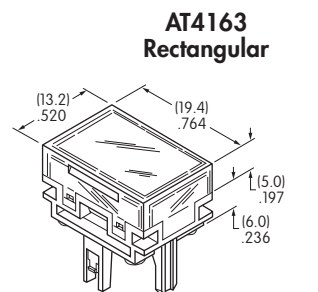
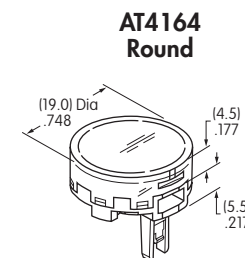
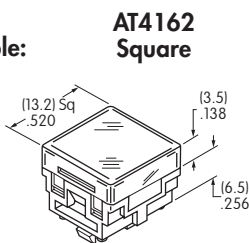

Transparent Clear Lens

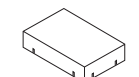

Translucent Colored Diffuser



Bright LED AT627

Material: Polycarbonate Finish: Glossy

CAP TYPES & COLOR COMBINATIONS

Cap for Super Bright LEDs



Clear Lens
White Diffuser

AT4129
Square

AT4128
Round

AT4130
Rectangular

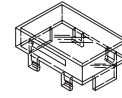

Transparent
Clear Lens

Material:
Polycarbonate
Finish: Glossy

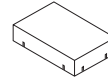
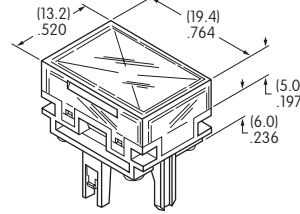
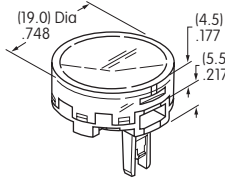
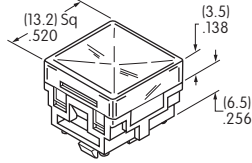

Translucent
White Diffuser



LEDs AT625
AT631 AT632

TYPICAL INDICATOR DIMENSIONS

Square

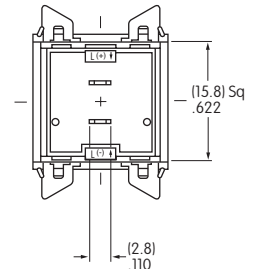
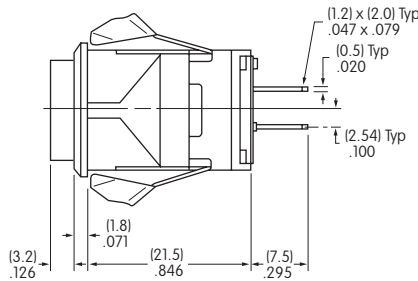
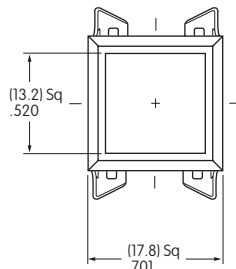

LB01KW01-12-CJ

Round

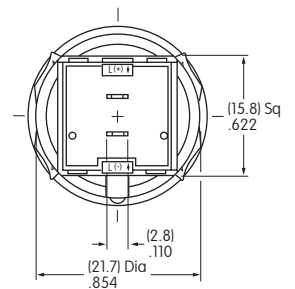
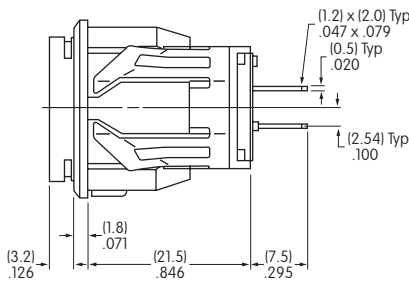
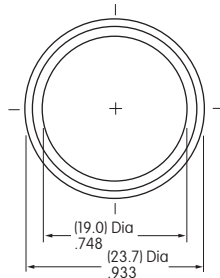

LB02KW01-12-CJ

Rectangular

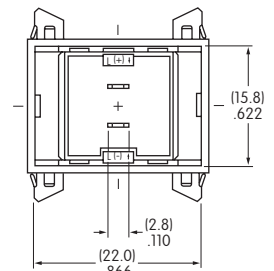
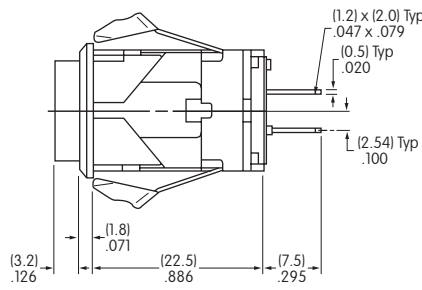
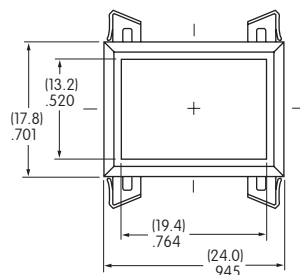

LB03KW01-12-CJ

X-ON Electronics

Largest Supplier of Electrical and Electronic Components

Click to view similar products for [Industrial Panel Mount Indicators / Switch Indicators](#) category:

Click to view products by [NKK Switches](#) manufacturer:

Other Similar products are found below :

[LW1A-P1-GD](#) [LW1A-P1-W](#) [01-931.3](#) [01-152.025](#) [73.362.4028.0](#) [750-1520](#) [9001OA120](#) [A0142N5](#) [A3DT-500Y](#) [AL6M-LK3-R](#) [AL6M-P7P-A](#) [AOLQW-2B0600](#) [AP1M255-A](#) [APD106LN-G](#) [APD106LN-S](#) [APN1126-G](#) [APS122DN-W](#) [ASLWLD-G](#) [ASLWLD-R](#) [ATN2100](#) [AYLW4L-A](#) [18-237.035](#) [18-945](#) [HW1A-L1-GD](#) [HW1A-P2-GL](#) [HW1X-BM411-R](#) [HW2A-L1-GL](#) [HW2A-P1-GD](#) [HWAZ1N-OB](#) [PA2100/2](#) [PA2200/1](#) [PA2SHIELD](#) [PAMR25](#) [LA3P-1C03V-Y](#) [96-923.5](#) [A0244J2](#) [LSPD-120A](#) [LSPD-1Y](#) [LSPD-6A](#) [LSPD-6DA](#) [LSPD-6DW](#) [LSPD-6DY](#) [LSPD-6R](#) [LSPD-6W](#) [18-946](#) [AL6H-LK3-A](#) [AL6H-P4-JW](#) [AL6M-LK1-MG](#) [AP8M155-G](#) [APD106LN-W](#)