

New Product

CN-0295

High Visibility Spot Illumination



LP01 Series

New Addition to Compact Body
Illuminated Pushbutton Switches

General Specifications

Electrical Capacity (Resistive Load)

Power Level (silver): 3A @ 125V AC or 3A @ 250V AC or 3A @ 30V DC

Other Ratings

Contact Resistance: 50 milliohms maximum (DC2 ~ 4V 100mA)
Insulation Resistance: 200 megohms minimum @ 500V DC
Dielectric Strength: 1,000V AC minimum between contacts for 1 minute minimum;
 1,500V AC minimum between contacts and case for 1 minute minimum
Mechanical Life: 500,000 operations minimum
Electrical Life: 50,000 operations minimum for 3A @ 125/250V AC & 3A @ 30V DC;
 100,000 operations minimum for 1A @ 125/250V AC & 1A @ 30V DC
Nominal Operating Force: 1.5 ± 0.7N for Single Pole; 3.0 ± 1.2N for Double Pole
Travel: 3.0mm (.118")

Environmental Data

Operating Temperature Range: -10°C through +50°C (+14°F through +122°F)

Processing

Soldering: Manual Soldering: 390°C maximum @ 4 seconds maximum, 2 cycles

Distinctive Characteristics

Vivid, super bright LED spot illumination in red, amber or green provides easy status recognition.

Smooth, slightly concave surface of cap designed to fit fingertip. Unique design and construction of cap prevents its removal and limits tampering.

Installation options include 16mm bushing mount or 17.3mm snap-in mount.

Short body of .551" (14.0mm) conserves behind-panel space.

Combination solder lug and .110" quick connect terminals are epoxy sealed to prevent entry of flux, dust, other contaminants.

Crisp actuation and clear circuit status provided by snap-action contact mechanism. Arc barrier between movable contacts protects against crossover.

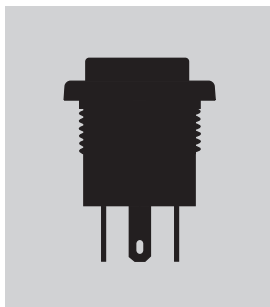
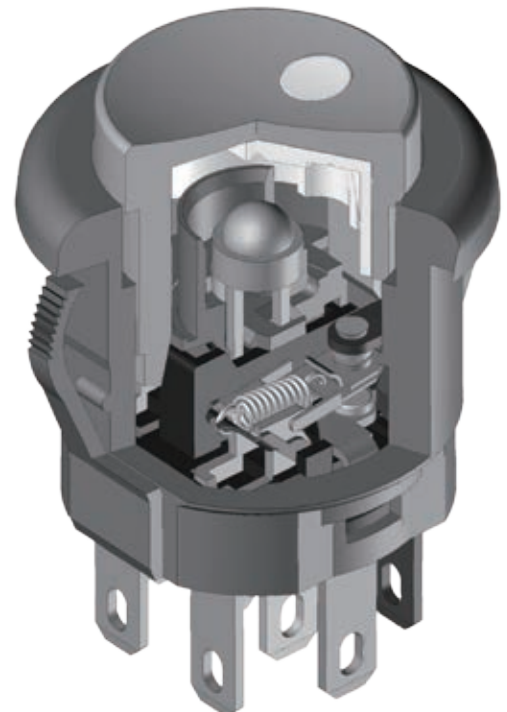

Actual Size

Applications

- Communication Equipment
- Test Instruments
- Automation Equipment
- Wireless Devices
- Office Equipment
- Household Appliances

TYPICAL SWITCH ORDERING EXAMPLE

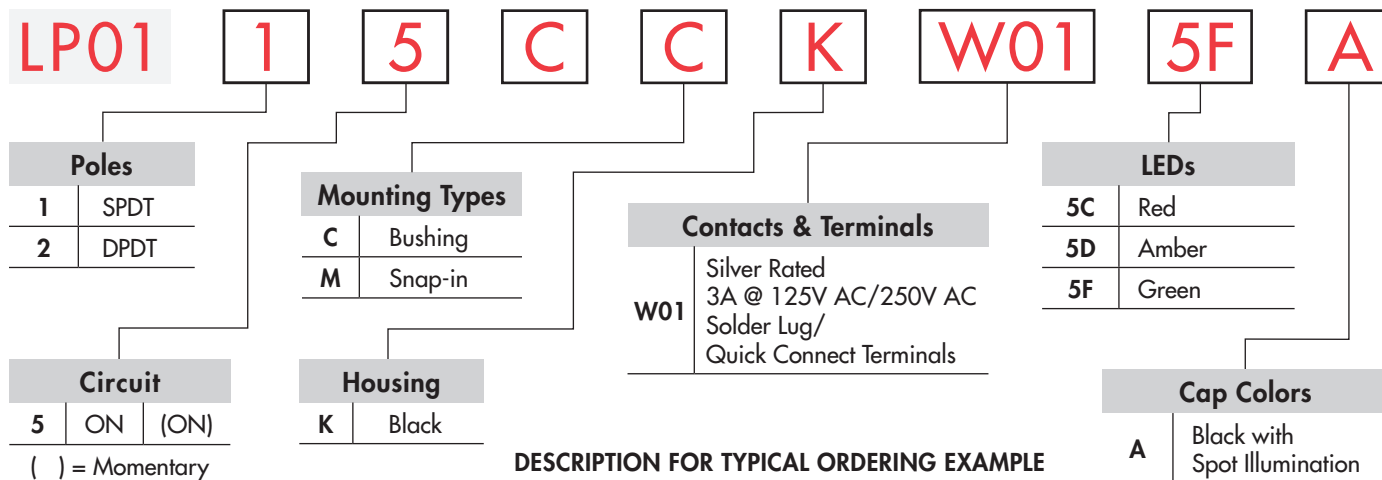

LP0115CCKW015FA

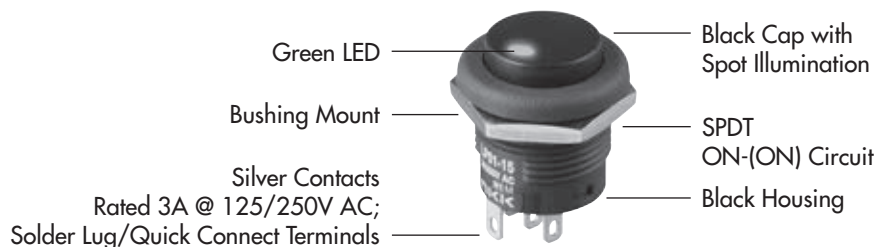

POLES & CIRCUIT

Pole	Model	Plunger Position () = Momentary		Connected Terminals		Throw & Power/Lamp Schematics
		Normal	Down	Normal	Down	
SP	LP0115	ON	(ON)	1-3	1-2	SPDT Note: Terminal markings "COM, NO, NC, L, + and -" are actually on the switch; terminal numbers are not on the switch.
DP	LP0125	ON	(ON)	1-3 4-6	1-2 4-5	DPDT

MOUNTING TYPES

C

Bushing

.630" (16.0mm) Diameter

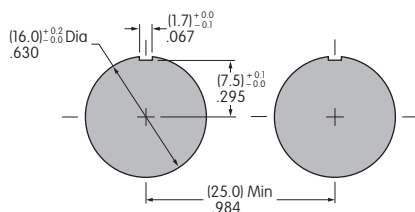

Allow .984" (25.0mm) distance from center-to-center between switches when mounted side-by-side.

Supplied with a steel hexagon nut with nickel plating.



Recommended Panel Thickness:
.079" ~ .256"
(2.0mm ~ 6.5mm)

M

Snap-in

.669" (17.0mm) Diameter

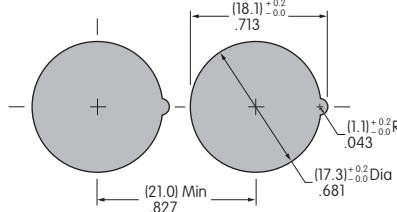

Allow .827" (21.0mm) distance from center-to-center between switches when mounted side-by-side.

Cut hole in panel with nub as shown to prevent rotation. Position switch vertically in cutout.



Recommended Panel Thickness:
.039" ~ .126"
(1.0mm ~ 3.2mm)

LED COLORS & SPECIFICATIONS

LEDs are an integral part of the switch and are not available separately. The electrical specifications shown are determined at a basic temperature of 25°C. LED circuit is isolated and requires external power source. Polarity marks are on the switch. If the source voltage exceeds the rated voltage, a ballast resistor is required. The resistor value can be calculated by using the formula shown here.

Single Color LED with 1 Element 	Colors	Red 5C	Amber 5D	Green 5F
Maximum Forward Current	I_{FM}	30mA	30mA	30mA
Typical Forward Current	I_F	20mA	20mA	20mA
Forward Voltage	V_F	1.95V	2.0V	2.1V
Maximum Reverse Voltage	V_{RM}	5V	5V	5V
Current Reduction Rate Above 25°C	ΔI_F	0.41mA/°C	0.29mA/°C	0.39mA/°C
Ambient Temperature Range		-10°C ~ +50°C		

$$R = \frac{E - V_F}{I_F}$$

Where: R = Resistor Value (Ohms)
E = Source Voltage (V)
 V_F = Forward Voltage (V)
 I_F = Forward Current (A)

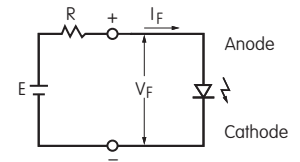

CAP COLORS

Spot Illuminated Cap

Cap Color Available:



Black with Spot Illumination



Material: Polycarbonate Finish: Matte

The cap is an integral part of the switch and is not available separately.

TYPICAL SWITCH DIMENSIONS

Bushing Mount



LP0115CCKW015CA

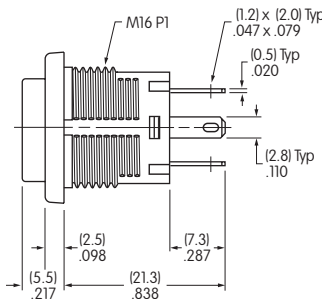
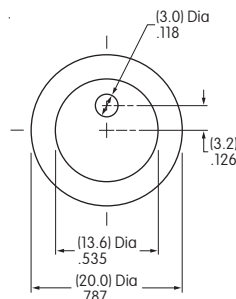

Single Pole

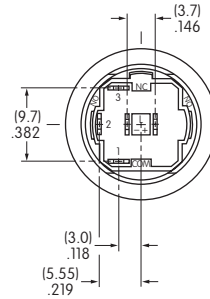

Double Pole

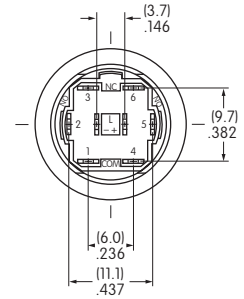

Snap-in Mount



LP0115CMKW015CA

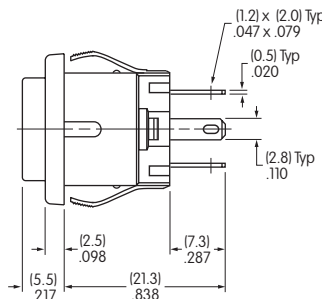
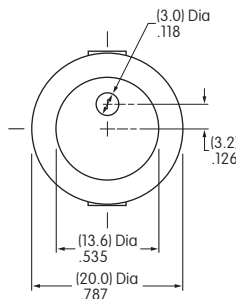

Single Pole

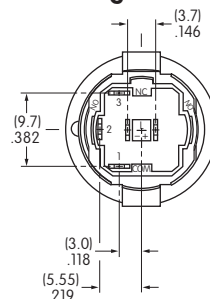

Double Pole

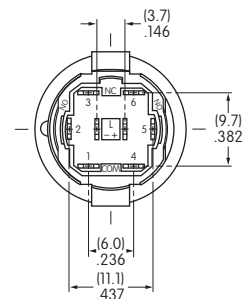

Effective Date October 2016

NIKK
SWITCHES

http://www.nkkswitches.com • 1.877.2BUYNIKK (228.9655)
7850 East Gelding Drive • Scottsdale, AZ 85260 • Telephone 480.991.0942 • Fax 480.998.1435

X-ON Electronics

Largest Supplier of Electrical and Electronic Components

Click to view similar products for [Pushbutton Switches](#) category:

Click to view products by [NKK Switches](#) manufacturer:

Other Similar products are found below :

[8940K2012](#) [LW1L-M1C10V-A](#) [LW1L-M1C70-A](#) [LW2L-A1C20M-GD](#) [LW2L-M1C20M-A](#) [60324L](#) [M22-D-R-GB0/K11](#) [M7E-HRN2](#)
[67021K512](#) [67081K512X](#) [701PB580](#) [7199K101](#) [810K12910](#) [810KSV30B](#) [MML21EA2ADK](#) [MML21KA3ABK](#) [MML23KA3AC05K-001](#)
[MML23KW3AA01W](#) [8418K2](#) [8442K3](#) [8450K1](#) [860K11911T01A](#) [861901](#) [861K11911T01A07](#) [861K13810T00A14](#) [861K13911](#)
[8646AB6X718UL](#) [8646ABUL](#) [9001KXRK](#) [907AYY100](#) [PMHD155A1](#) [9533CD4+U574+U4922](#) [95-414.000](#) [99-450.837](#) [99-453.837](#)
[PV3H2B0NN-341](#) [1203MRA](#) [A22NZBGANGA](#) [A22NZBMMNGA](#) [A22NZBNANGA](#) [A22NZMPATRA](#) [A2PMA1X03EC56](#) [A3A-5123-02](#)
[A3A-7140](#) [A3A-7310](#) [A3A-7340](#) [A3U-TMW-A2C-5M](#) [A595](#) [12037A2ULCSA](#) [ABD122N-B](#)