

# General Specifications

## Electrical Capacity

<b>Resistive Load:</b>	10A @ 125V AC or 6A @ 250V AC
<b>Motor Load:</b>	400W @ 125V AC
<b>Lamp Load:</b>	2A @ 125V AC for On-Off-On circuit & 3A @ 125V AC for other circuits

## Other Ratings

<b>Contact Resistance:</b>	10 milliohms maximum
<b>Insulation Resistance:</b>	1,000 megohms minimum @ 500V DC
<b>Dielectric Strength:</b>	2,000V AC minimum between contacts for 1 minute minimum; 4,000V AC minimum between contacts & case for 1 minute minimum
<b>Mechanical Life:</b>	100,000 operations minimum
<b>Electrical Life:</b>	25,000 operations minimum
<b>Angle of Throw:</b>	25°

## Materials & Finishes

<b>Toggle Cap:</b>	Polypropylene for No Code, Code D; Polyvinyl chloride for Code B (see Ordering Example)
<b>Lever:</b>	Brass with chrome plating
<b>Bushing:</b>	Brass with nickel plating
<b>Frame:</b>	Stainless steel
<b>Case/Base:</b>	Diallyl phthalate resin (UL94V-0)
<b>Movable Contacts:</b>	Silver alloy with silver plating
<b>Stationary Contacts:</b>	Pure silver with silver plating
<b>Terminals:</b>	Copper with silver plating

## Environmental Data

<b>Operating Temp Range:</b>	-10°C through +85°C (+14°F through +185°F)
<b>Humidity:</b>	90 ~ 95% humidity for 96 hours @ 40°C (104°F)
<b>Vibration:</b>	10 ~ 55Hz with peak-to-peak amplitude of 1.5mm traversing the frequency range & returning in 1 minute; 3 right angled directions for 2 hours
<b>Shock:</b>	50G (490m/s <sup>2</sup> ) acceleration (tested in 6 right angled directions, with 5 shocks in each direction)

## Installation

<b>Soldering Time &amp; Temp:</b>	Wave Soldering Recommended (Straight PC): See Profile A in Supplement section. Manual Soldering: See Profile A in Supplement section.
<b>Cleaning:</b>	These devices are not process sealed. Hand clean locally using alcohol based solution.

## Standards & Certifications

<b>Flammability Standards:</b>	UL94V-0 rated case/base
<b>UL:</b>	<b>File No. E44145 - Recognized only when ordered with marking on switch.</b> Add "/U" or "/CUL" to end of part number to order UL recognized switch. Models with No Code, E, F & D are recognized at 10A @ 125V AC & 6A @ 250V AC.
<b>CSA:</b>	<b>File No. 023535_0_000 - Certified only when ordered with marking on switch.</b> Add "/C" to end of part number to order CSA certified switch. Models with No Code, E, F and D are certified at 10A @ 125V AC & 6A @ 250V AC.
<b>VDE:</b>	<b>License No. 119174</b> Models with No Code, B & D are approved at 10A @ 125V AC & 6A @ 250V AC. Models with No Code, B & D meet EN 61058-1 standard.

# Distinctive Characteristics

Meets EN 61058-1 standard.

High torque bushing construction prevents rotation or separation from frame during installation.

Stainless steel frame resists corrosion and increases environmental safety.

Case/base of heat resistant resin meets UL94V-0 flammability standard.

Contacts of special silver alloy resist arcing and guarantee stable electrical contact and long life.

High insulating barriers increase isolation of circuits in double pole devices and provide added protection to contact points.

Prominent external insulating barriers increase insulation resistance and dielectric strength.

Epoxy sealed terminals prevent entry of flux, solvents, and other contaminants.

Clinching of the frame to the case well above the base and terminals provides 4,000V dielectric strength.

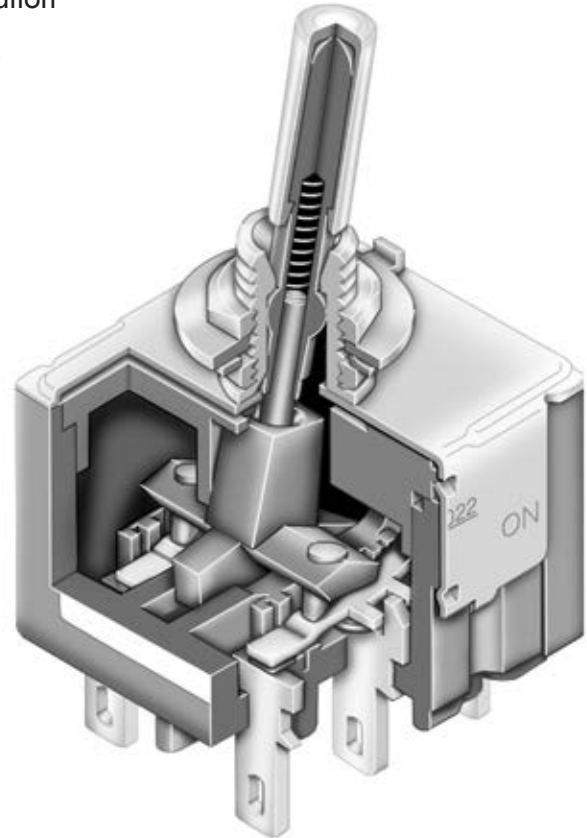

Actual Size

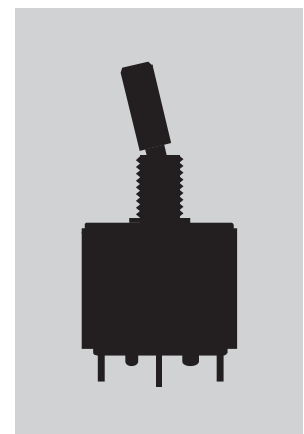

- A Toggles
- Rockers
- Pushbuttons
- Illuminated PB
- Programmable
- Keylocks
- Rotaries
- Slides
- Tactiles
- Tilt
- Touch
- Indicators
- Accessories
- Supplement

### TYPICAL SWITCH ORDERING EXAMPLE

P20

22

B



Poles & Circuits				
11	SPST	ON	NONE	OFF
12	SPDT	ON	NONE	ON
13	SPDT	ON	OFF	ON
21	DPST	ON	NONE	OFF
22	DPDT	ON	NONE	ON
23	DPDT	ON	OFF	ON

Toggles & Bushings	
No Code	.512" (13.0mm) White Cap with 6mm Bushing
E	.450" (11.4mm) Flatted with 6mm Bushing
B	.689" (17.5mm) Large Bat & AT406B Cap with 12mm Bushing
F	.689" (17.5mm) Large Bat with 12mm Bushing
D	.748" (19.0mm) White Capped Column with 12mm Bushing

Terminals	
No Code	Solder Lug
P	Straight PC
Z	.187" (4.75mm) Quick Connect

#### DESCRIPTION FOR TYPICAL ORDERING EXAMPLE

**P2022F**

.689" (17.5mm) Large Bat with 12mm Bushing

DPDT ON-NONE-ON Circuit

Solder Lug Terminals



#### IMPORTANT:

VDE is marked on all models except those with codes E & F. Switches are supplied without UL, cULus & CSA marking unless specified. **UL, cULus & CSA recognized only when ordered with marking on the switch.** Specific models, ratings, & ordering instructions are noted on the General Specifications page.



### POLES & CIRCUITS

Pole	Model	Toggle Position			Connected Terminals			Throw & Schematics
		Down <small>Keyway</small>	Center	Up	Down <small>Keyway</small>	Center	Up	
SP	P2011	ON	NONE	OFF	1-1b	OPEN	OPEN	SPST 
SP	P2012 P2013	ON ON	NONE OFF	ON ON	1-1b	OPEN	1-1a	SPDT 
DP	P2021	ON	NONE	OFF	1-1b 2-2b	OPEN	OPEN	DPST 
DP	P2022 P2023	ON ON	NONE OFF	ON ON	1-1b 2-2b	OPEN	1-1a 2-2a	DPDT 

## TOGGLES & BUSHINGS

**No Code**

**.512" (13.0mm) White Cap with 6mm Bushing**

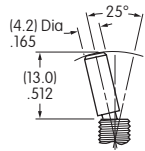

**E**

**.450" (11.4mm) Flatted with 6mm Bushing**

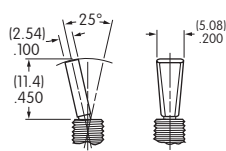

**B**

**.689" (17.5mm) Large Bat & AT406B Cap with 12mm Bushing**

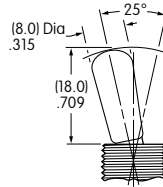

**F**

**.689" (17.5mm) Large Bat with 12mm Bushing**

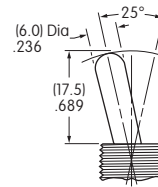

**D**

**.748" (19.0mm) White Capped Column with 12mm Bushing**

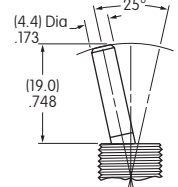

### Panel Cutouts

Panel Thickness with Keyway  
**.134" (3.4mm) maximum**

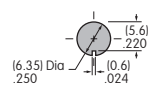

Panel Thickness with Locking Ring  
**.102" (2.6mm) maximum**

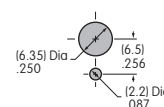

Panel Thickness with Keyway  
**.256" (6.5mm) maximum**

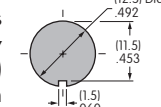

Panel Thickness with Locking Ring  
**.217" (5.5mm) maximum**

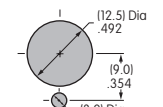

### Standard Hardware

**For 6mm Bushing:** 1 Locking Ring AT507M, 1 Internal Tooth Lockwasher AT509, 2 Hex Nuts AT513M

**For 12mm Bushing:** 1 Hex Face Nut AT503M, 1 Locking Ring AT506M, 1 Internal Tooth Lockwasher AT508, 1 Hex Mounting Nut AT527M

**Optional Splashproof Boot Assemblies (for code F):** AT401 & AT4181 boots plus hex nut & o-ring; see Accessories & Hardware section.

## TERMINALS

**No Code**

**Solder Lug**

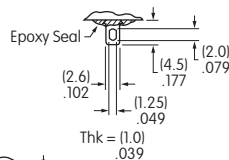

**Z**

**.187" (4.75mm) Quick Connect**

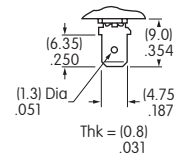

**P**

**Straight PC**

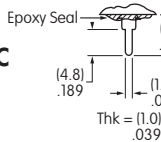

**SPST**

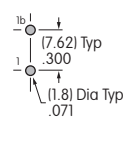

**SPDT**

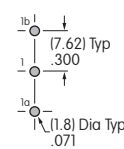

**DPST**

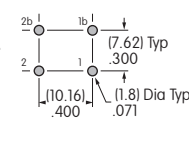

**DPDT**

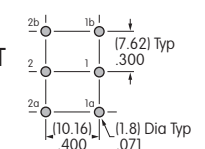

## TYPICAL SWITCH DIMENSIONS

### P2011, P2012, P2013

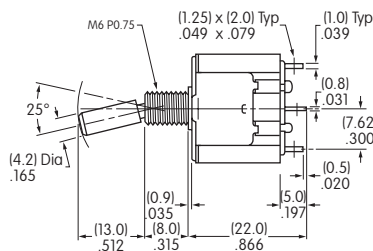
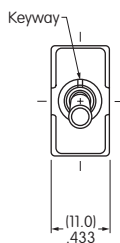

P2011 models do not have terminal 1a.

### 6mm Bushing



**P2012**

### P2021F, P2022F, P2023F

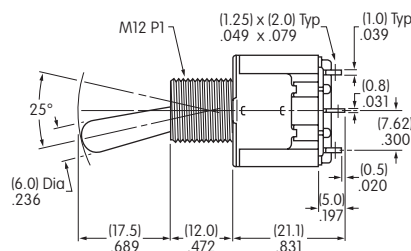
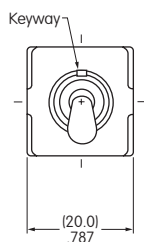

P2021 models do not have terminals 1a & 2a.

### 12mm Bushing



**P2022F**

## X-ON Electronics

Largest Supplier of Electrical and Electronic Components

*Click to view similar products for [Toggle Switches](#) category:*

*Click to view products by [NKK Switches](#) manufacturer:*

Other Similar products are found below :

[8928K478](#) [020017-13](#) [60012L](#) [6006L](#) [CS115W](#) [CS120W](#) [637H/25](#) [6663](#) [7101SPDV30BE](#) [7103SDV30BE](#) [7105D](#) [7108P3YAV2BE](#)  
[71YY50282](#) [7300K36](#) [7301K38](#) [7306K36](#) [7310K36](#) [7506K4](#) [7592K6](#) [7660K12](#) [7691K14](#) [7700K1](#) [8391K108](#) [8396K108](#) [8811K17](#)  
[8824K14](#) [8828K13](#) [8835K3](#) [8858K44](#) [PS83-121G](#) [1-1825192-0](#) [A201SCWZB04](#) [A207SYCB04](#) [A208J61ZQ0004](#) [A221T1TCQ](#)  
[A323S1CWZQ](#) [A423S1CWZG-M8](#) [1201W](#) [12156AX408](#) [12147AGKX679](#) [12246X778](#) [12TW49-3D](#) [130312](#) [13037L](#) [13001X](#)  
[AE101MD1W4B04](#) [AE208SD1W4B04](#) [MS24659-22D](#) [MS27407-5](#) [1520230-9](#)