

# General Specifications

## Electrical Capacity (Resistive Load)

**Power Level (silver):** 5A @ 125/250V AC or 5A @ 30V DC  
**Logic Level (gold):** 0.4VA maximum @ 28V AC/DC maximum  
 (Applicable Range 0.1mA ~ 0.1A @ 20mV ~ 28V)  
 Note: Find additional explanation of operating range in Supplement section.

## Other Ratings

**Contact Resistance:** 50 milliohms maximum for silver; 100 milliohms maximum for gold  
**Insulation Resistance:** 200 megohms minimum @ 500V DC  
**Dielectric Strength:** 1,000V AC minimum between contacts for 1 minute minimum;  
 1,500V AC minimum between contacts & case for 1 minute minimum

**Mechanical Life:** 1,000,000 operations minimum for momentary;  
 200,000 operations minimum for alternate action

**Electrical Life:** 10,000 operations minimum for silver;  
 200,000 operations minimum for gold

**Nominal Operating Force:** Single Pole: 1.90N  
 Double Pole: 2.55N

**Contact Timing:** Break before make  
**Travel:** Pretravel .067" (1.7mm); Overtravel .024" (0.6mm); Total Travel .091" (2.3mm)

## Materials & Finishes

**Housing/Bezel:** Glass fiber reinforced polyamide (UL94V-0)  
**Snap-in Frame:** Stainless steel  
**Movable Contactor:** Phosphor bronze  
**Movable Contacts:** Silver alloy or copper with gold plating  
**Stationary Contacts:** Silver alloy or copper with gold plating  
**Switch Terminals:** Phosphor bronze with silver or gold plating  
**Lamp Terminals:** Brass with tin plating  
**Base:** Glass fiber reinforced liquid crystal polymer (UL94V-0)

## Environmental Data

**Operating Temperature Range:** -25°C through +50°C (-13°F through +122°F) for Illuminated  
 -25°C through +70°C (-13°F through +158°F) for Nonilluminated  
**Humidity:** 90 ~ 95% humidity for 240 hours @ 40°C (104°F)  
**Vibration:** 10 ~ 55Hz with peak-to-peak amplitude of 1.5mm traversing the frequency range & returning in 1 minute; 3 right angled directions for 2 hours  
**Shock:** 50G (490m/s<sup>2</sup>) acceleration (tested in 6 right angled directions, with 5 shocks in each direction)

## Installation

**Cap Installation Force:** 15.0N maximum downward force on cap

## Processing

**Soldering:** Wave Soldering (PC version): See Profile A in Supplement section.  
 Manual Soldering: See Profile A in Supplement section.  
**Cleaning:** These devices are not process sealed. Hand clean locally using alcohol based solution.

## Standards & Certifications

**Flammability Standards:** UL94V-0 housing/bezel & base  
**UL:** **File No. E44145 - Recognized only when ordered with marking on switch.**  
 Add "/U" or "/CUL" before dash in part number to order UL recognized switch.  
 UL recognized only when ordered switch body with cap assembled.  
 All single & double pole models recognized at 5A @ 125/250V AC or 0.014A @ 28V DC.

# Distinctive Characteristics

Wide selection of illumination effects is achieved with single and bicolor, 1- or 6-element LEDs in flat, beveled, or sculptured caps.

Alternating legends in choice of sculptured or flat caps, combined with super bright bicolor LED.

Combination of PCB mountability and short body allows use in compact applications.

Small behind panel dimension for snap-in mounting in tight spaces.

Snap-acting contact mechanism provides sensitive actuation with audible feedback; quick-make, quick-break characteristic limits arcing and prolongs electrical life.

Latchdown mechanism, independent of switching mechanism, gives outstanding stability and reliability plus visible and tactile indication of circuit status.

Terminals are epoxy sealed to lock out flux, solvents, and other contaminants.

Momentary and alternate action circuits available in the same space-saving body size.

Matching indicators available.

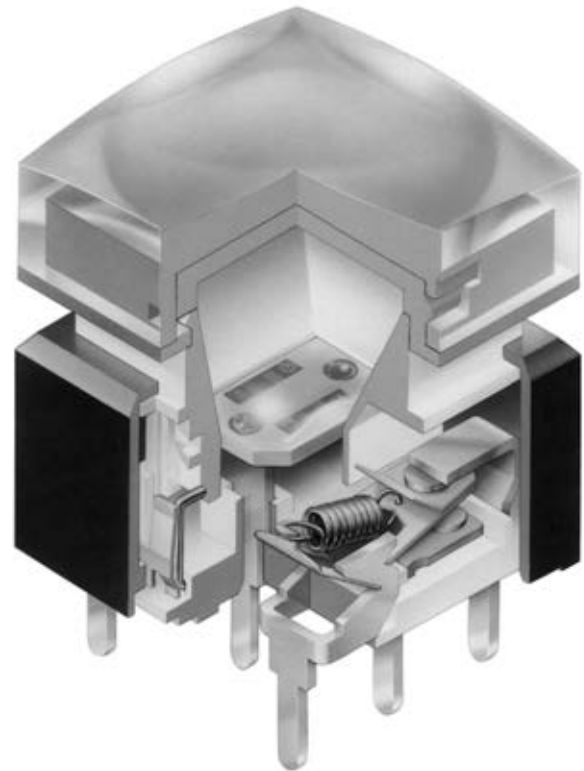

Actual Size

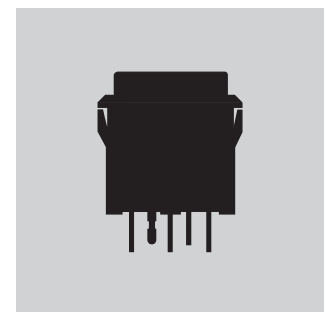

- Toggles
- Rockers
- Pushbuttons
- D Illuminated PB**
- Programmable
- Keylocks
- Rotaries
- Slides
- Tactiles
- Tilt
- Touch
- Indicators
- Accessories
- Supplement

### TYPICAL SWITCH

# UB2

# 1

# 5

# SK

# G

# 03

#### Poles

1	SPDT
2	DPDT

#### Circuits

5	ON	(ON)
( ) = Momentary		
6	ON	ON
Alternate Action with Latchdown		

#### Mounting Types

##### PCB Mounting

SK	Square
* Snap-in Mounting	
KK	Square
* Standard with Solder Lug terminals	

#### Terminals

01	Solder Lug (for Snap-in Mounting)
03	Straight PC

#### Contacts & Ratings

W	Silver Rated 5A @ 125/250V AC
G	Gold Rated 0.4VA max @ 28V AC/DC max

#### Part Numbers for Alternating Legends

Color	15mm Square Sculptured Cap	15mm Square Flat Cap
	Part Number	Part Number
Red/Green	AT3069JCF11 ~ AT3069JCF14	AT3070JCF11 ~ AT3070JCF14
Amber/Blue	AT3069JDG11 ~ AT3069JDG14	AT3070JDG11 ~ AT3070JDG14

Refer to Ordering Table for Alternating Legend that corresponds with last 2 digits of part number.

#### IMPORTANT:



Switches are supplied without UL & cULus marking unless specified. **UL & cULus recognized only when ordered with marking on switch.** Specific models, ratings, & ordering instructions are noted on the General Specifications page.

#### DESCRIPTION FOR TYPICAL ORDERING EXAMPLE

### UB215SKG035C-1JC



Toggles  
Rockers  
Pushbuttons  
Illuminated PB  
Programmable  
Keylocks  
Rotaries  
Slides  
Tactiles  
Tilt  
Touch  
Indicators  
Accessories  
Supplement

## ORDERING EXAMPLE

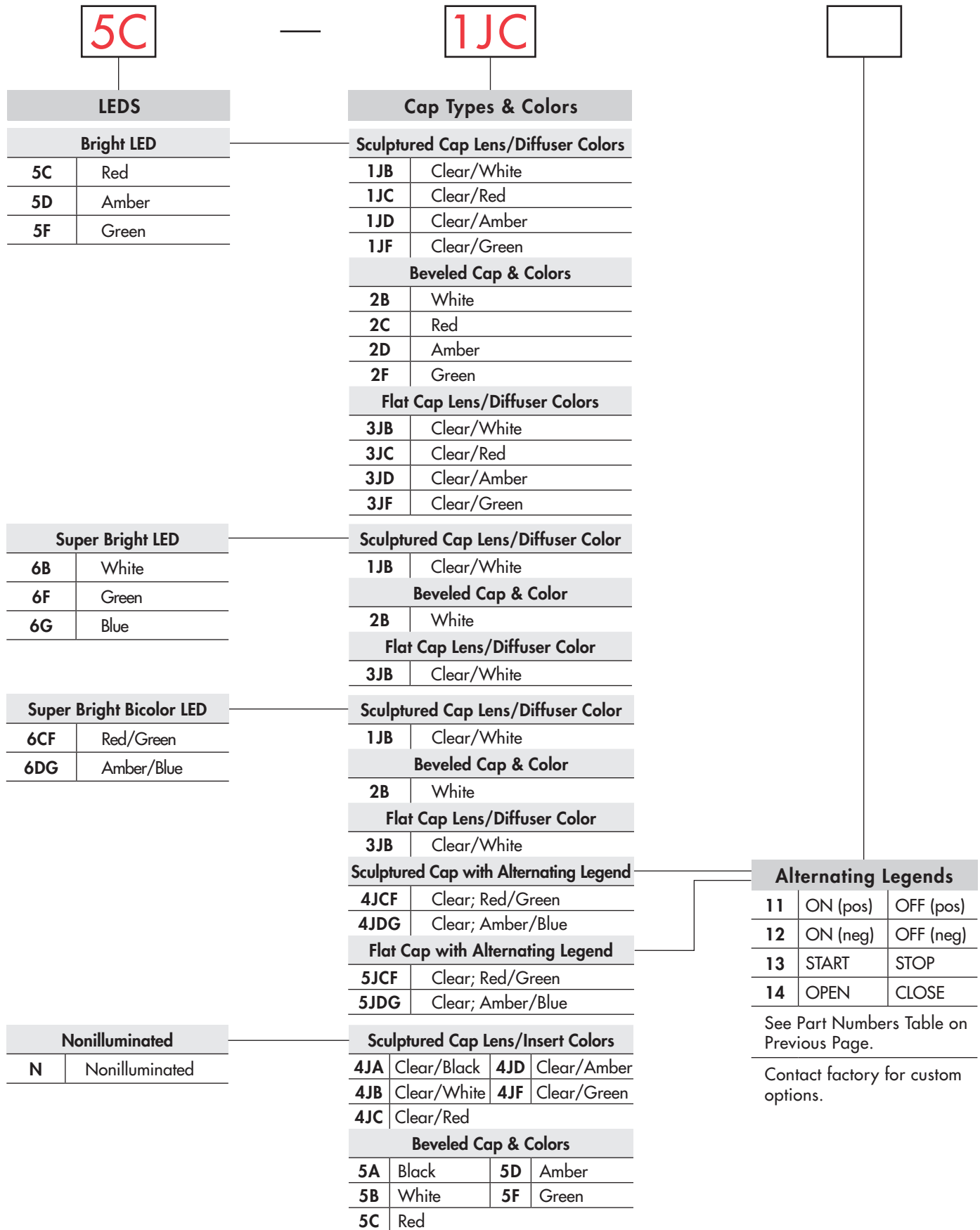

**5C**

**1JC**

**LEDs**

Bright LED	
5C	Red
5D	Amber
5F	Green

Super Bright LED	
6B	White
6F	Green
6G	Blue

Super Bright Bicolor LED	
6CF	Red/Green
6DG	Amber/Blue

Nonilluminated	
N	Nonilluminated

**Cap Types & Colors**

Sculptured Cap Lens/Diffuser Colors	
1JB	Clear/White
1JC	Clear/Red
1JD	Clear/Amber
1JF	Clear/Green

Beveled Cap & Colors	
2B	White
2C	Red
2D	Amber
2F	Green

Flat Cap Lens/Diffuser Colors	
3JB	Clear/White
3JC	Clear/Red
3JD	Clear/Amber
3JF	Clear/Green

Sculptured Cap Lens/Diffuser Color	
1JB	Clear/White

Beveled Cap & Color	
2B	White

Flat Cap Lens/Diffuser Color	
3JB	Clear/White

Sculptured Cap Lens/Diffuser Color	
1JB	Clear/White

Beveled Cap & Color	
2B	White

Flat Cap Lens/Diffuser Color	
3JB	Clear/White

Sculptured Cap with Alternating Legend	
4JCF	Clear; Red/Green
4JDG	Clear; Amber/Blue

Flat Cap with Alternating Legend	
5JCF	Clear; Red/Green
5JDG	Clear; Amber/Blue

Sculptured Cap Lens/Insert Colors			
4JA	Clear/Black	4JD	Clear/Amber
4JB	Clear/White	4JF	Clear/Green
4JC	Clear/Red		

Beveled Cap & Colors			
5A	Black	5D	Amber
5B	White	5F	Green
5C	Red		

**Alternating Legends**

11	ON (pos)	OFF (pos)
12	ON (neg)	OFF (neg)
13	START	STOP
14	OPEN	CLOSE

See Part Numbers Table on Previous Page.

Contact factory for custom options.

Toggles

Rockers

Pushbuttons

Illuminated PB

Programmable

Keylocks

Rotaries

Slides

Tactiles

Tilt

Touch

Indicators

Accessories

Supplement

## POLES & CIRCUITS

Pole	Model	Plunger Position ( ) = Momentary		Connected Terminals		Throw & Switch/Lamp Schematics
		Normal	Down	Normal	Down	
SP	UB215 *UB216	ON ON	(ON) ON	1-3	1-2	Notes: Switch is marked with NC, NO, COM, L+ & L-. Lamp circuit is isolated and requires an external power source. SPDT
DP	UB225 *UB226	ON ON	(ON) ON	1-3 4-6	1-2 4-5	DPDT

\* When in latchdown position for the alternate circuit, cap positions above the housing are: .059" (1.5mm) for snap-in models & .276" (7.0mm) for PCB models.

## MOUNTING TYPES & SHAPES

### PCB Mounting

**SK**

Square

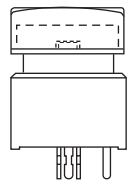

SP, Single Color LED

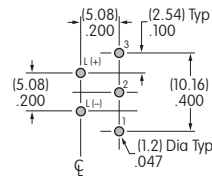

DP, Single Color LED

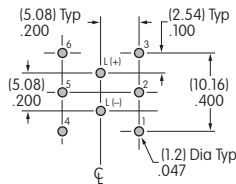

SP, Bicolor LED

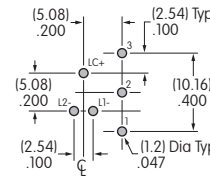

DP, Bicolor LED

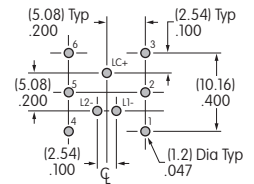

### Snap-in Mounting (Solder Lug)

**KK**

Square with Built-in Bezel

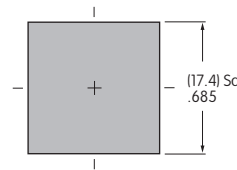
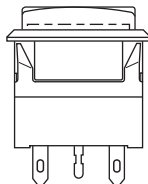

Panel Thickness:  
.039 ~ .126"  
(1.0 ~ 3.2mm)

## CONTACT MATERIALS & RATINGS

**W**

Silver Contacts

Power Level

5A @ 125V AC & 250V AC

**G**

Gold Contacts

Logic Level

0.4VA maximum @ 28V AC/DC maximum

Complete explanation of operating range in Supplement section.

## SWITCH & LAMP TERMINALS

**01**

Solder Lug

For Switch & Bright LED

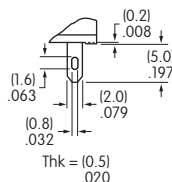

For Super Bright & Bicolor LED

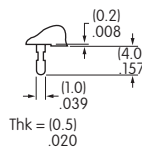

**03**

Straight PC

For Switch & Bright LED

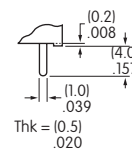

For Super Bright & Bicolor LED

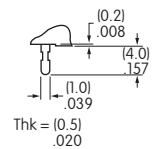

## BRIGHT LED & CAPS

The electrical specifications shown are determined at a basic temperature of 25°C.  
 LED circuit is isolated and requires an external power source. Polarity marks are on the bottom of the switch.  
 If the source voltage exceeds the rated voltage, a ballast resistor is required.  
 The resistor value can be calculated by using the formula in the Supplement section.

The LED is an integral part of the switch and not available separately.

### Electrical Specifications for Bright LED

		<b>5C</b>	<b>5D</b>	<b>5F</b>	
	Color	Red	Amber	Green	Unit
Maximum Forward Current	$I_{FM}$	30	30	25	mA
Typical Forward Current	$I_F$	20	20	20	mA
Forward Voltage	$V_F$	1.85	2.0	2.1	V
Maximum Reverse Voltage	$V_{RM}$	5	5	5	V
Current Reduction Rate Above 25°C	$\Delta I_F$	0.40	0.42	0.46	mA/°C
Ambient Temperature Range		-25° ~ +50°			°C

Bright Single Color LED with 1 element

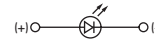

### Caps for Bright LED

#### 1 AT3074 Sculptured

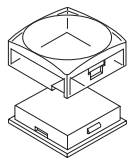
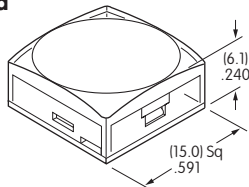

Clear Lens  
 Translucent Colored Diffuser

#### 2 AT3075 Beveled

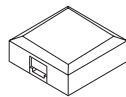
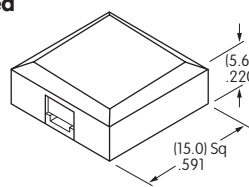

Translucent Colored Cap

#### 3 AT3076 Flat

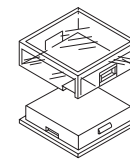
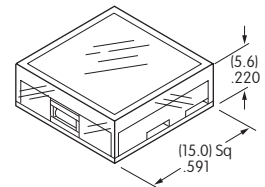

Clear Lens  
 Translucent Colored Diffuser

#### Lens/Diffuser Colors Available:

- JB** Clear/White
- JC** Clear/Red
- JD** Clear/Amber
- JF** Clear/Green

#### Cap Colors Available:

- B** White
- C** Red
- D** Amber
- F** Green

#### Lens/Diffuser Colors Available:

- JB** Clear/White
- JC** Clear/Red
- JD** Clear/Amber
- JF** Clear/Green

Material: Polycarbonate

Finish: Glossy

### SUPER BRIGHT LEDS & CAPS

The electrical specifications shown are determined at a basic temperature of 25°C. LED circuit is isolated and requires an external power source. Polarity marks are on the bottom of the switch. If the source voltage exceeds the rated voltage, a ballast resistor is required. The resistor value can be calculated by using the formula in the Supplement section. The LED is an integral part of the switch and not available separately.

#### Electrical Specifications for Super Bright LEDs

Super Bright LEDs are Electrostatic Sensitive		Color	<b>6B</b> White	<b>6F</b> Green	<b>6G</b> Blue	Unit
Maximum Forward Current		$I_{FM}$	20	30	30	mA
Typical Forward Current		$I_F$	15	20	20	mA
Forward Voltage		$V_F$	3.3	3.5	3.6	V
Maximum Reverse Voltage		$V_{RM}$	5	5	5	V
Current Reduction Rate Above 25°C		$\Delta I_F$	0.25	0.50	0.50	mA/°C
Ambient Temperature Range			-20° ~ +50°			°C

Super Bright Single Color LED with 1 element



#### Caps for Super Bright LED

**1JB**

**AT3074JB**  
Sculptured  
Clear Lens/  
White Diffuser

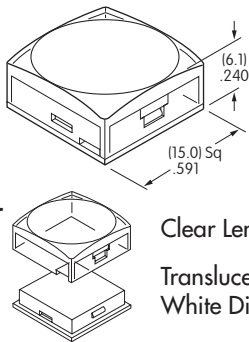

**2B**

**AT3075B**  
Beveled  
White Cap

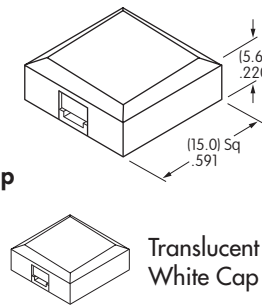

**3JB**

**AT3076JB**  
Flat  
Clear Lens/  
White Diffuser

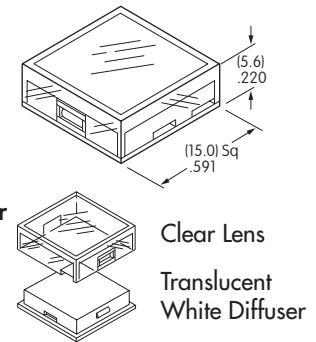

Material: Polycarbonate

Finish: Glossy

### SUPER BRIGHT BICOLOR LEDS & CAPS

The electrical specifications shown are determined at a basic temperature of 25°C. LED circuit is isolated and requires an external power source. Polarity marks are on the bottom of the switch. If the source voltage exceeds the rated voltage, a ballast resistor is required. The resistor value can be calculated by using the formula in the Supplement section. The LED is an integral part of the switch and not available separately.

#### Electrical Specifications for Super Bright Bicolor LEDs

Super Bright LEDs are Electrostatic Sensitive		Color	<b>6CF</b>		<b>6DG</b>		Unit
			Red	Green	Amber	Blue	
Maximum Forward Current		$I_{FM}$	30 * 25 for Amber	25 * 22 for Amber	30	30	mA
Typical Forward Current		$I_F$	20	20	15	15	mA
Forward Voltage		$V_F$	2.1	3.5	2.0	2.8	V
Maximum Reverse Voltage		$V_{RM}$	4	4	4	4	V
Current Reduction Rate Above 25°C		$\Delta I_F$	0.40	0.33	0.33	0.33	mA/°C
Ambient Temperature Range			-20° ~ +50°		-20° ~ +50°		°C

Super Bright Bicolor LED with 2 elements

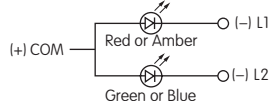

\* Amber color is achieved by lighting red and green simultaneously, but is not suitable for Alternating Legends.

## Caps for Super Bright Bicolor LED

**1JB** AT3074JB Sculptured Clear Lens/White Diffuser

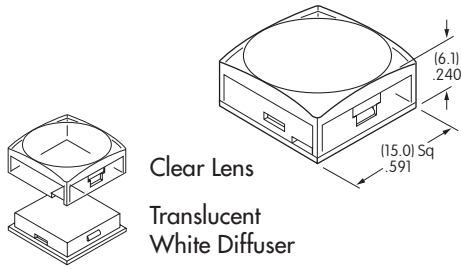

**2B** AT3075B Beveled White Cap

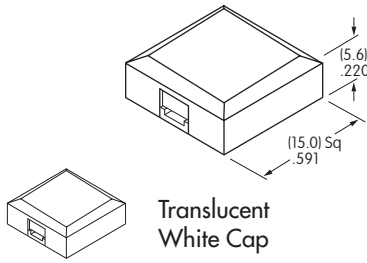

**3JB** AT3076JB Flat Clear Lens/White Diffuser

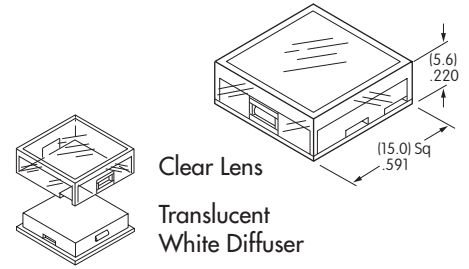

Material: Polycarbonate Finish: Glossy

## Alternating Legend Caps for Super Bright Bicolor LED

**AT3069J** Sculptured Cap with Alternating Legend

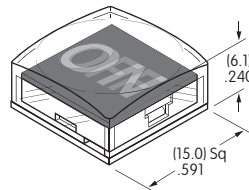

**AT3070J** Flat Cap with Alternating Legend

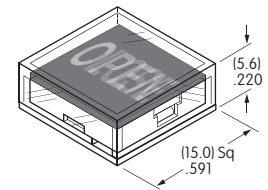

**4JCF** Red/Green

**5JCF** Red/Green

**4JDG** Amber/Blue

**5JDG** Amber/Blue

Clear Lens Alternating Legend Filter

Clear Lens Alternating Legend Filter

Material: Polycarbonate Finish: Glossy

## Standard Alternating Legend Pairs



Green/Red or Blue/Amber



Green/Red or Blue/Amber



Green/Red or Blue/Amber



Green/Red or Blue/Amber

Cap illumination is alternating Green/Red or Blue/Amber; legend text is black.  
Contact factory for other Alternating Legends.  
Legend illustrations are approximate representations of the actual characters on the filters.

**No Code** No Lamp

## CAP TYPES & COLOR COMBINATIONS FOR NONILLUMINATED

**4** AT3073 Sculptured

Lens/Insert Colors Available:

**JA** Clear/Black

**JB** Clear/White

**JC** Clear/Red

**JD** Clear/Amber

**JF** Clear/Green

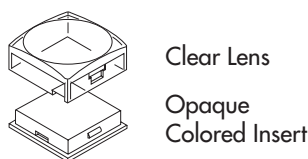

Material: Polycarbonate Finish: Glossy

**5** AT3077 Beveled

Cap Colors Available:

**A** Black

**B** White

**C** Red

**D** Amber

**F** Green

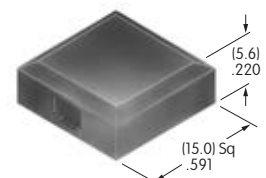

Material: Polycarbonate Finish: Glossy



## TYPICAL SWITCH DIMENSIONS

### Bright & Super Bright LED Straight PC

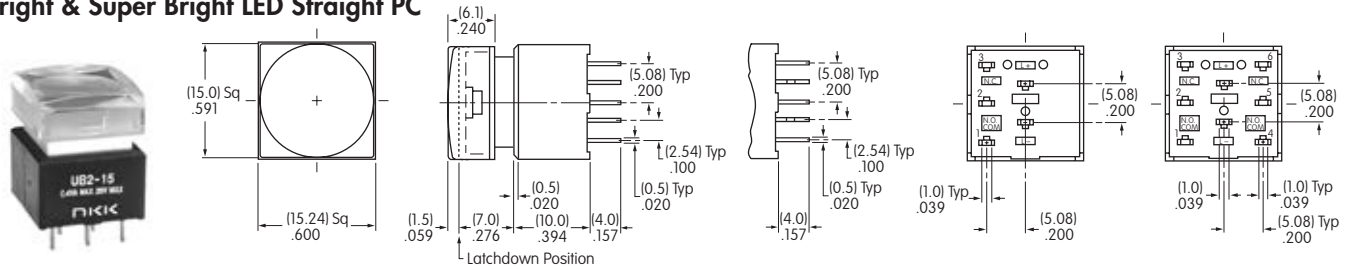

**UB215SKG035C-1JC**

Bright Single Color LED

Super Bright Single Color LED

Single Pole

Double Pole

### Bicolor LED Straight PC

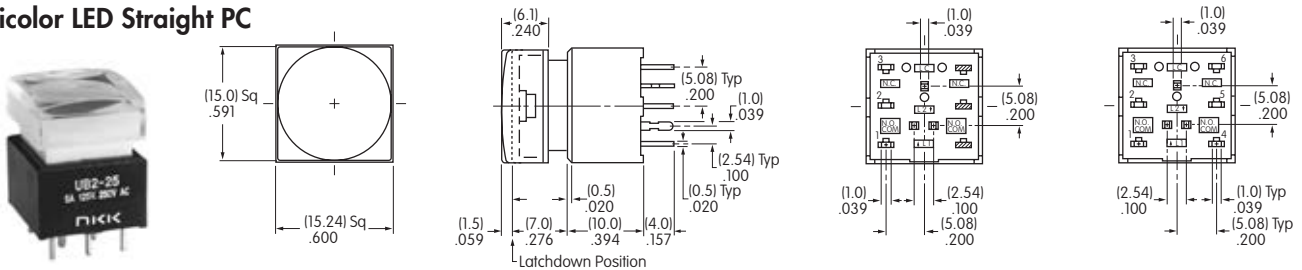

**UB225SKG03CF-1JB**

Bicolor LED Side View

Single Pole

Double Pole

### Bright LED Solder Lug

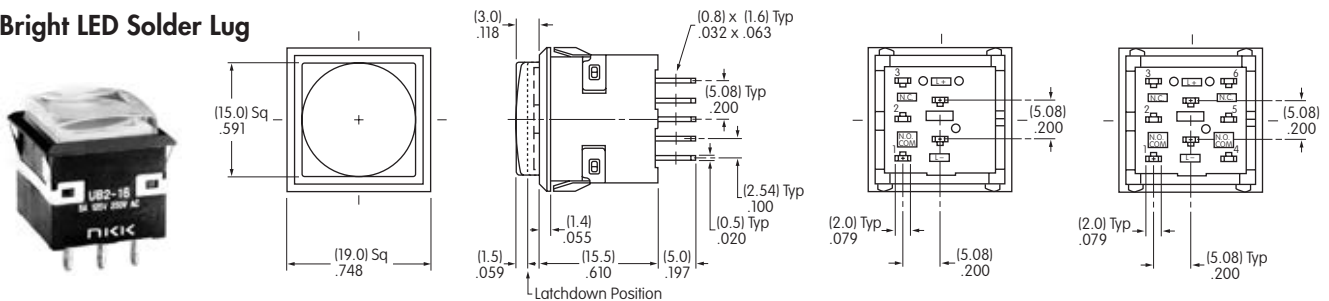

**UB216KKW015F-1JF**

Single Color LED Side View

Single Pole

Double Pole

### Super Bright LED Solder Lug

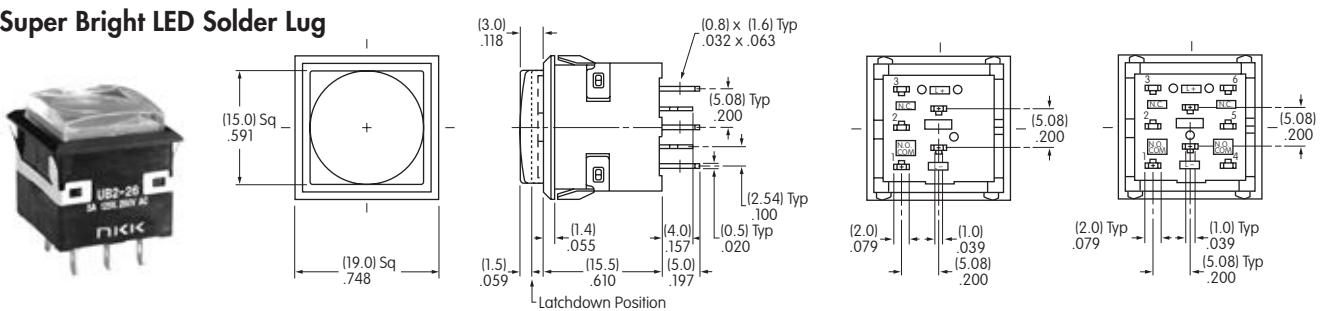

**UB226KKW016F-1JF**

Single Color LED Side View

Single Pole

Double Pole

### Bicolor LED Solder Lug

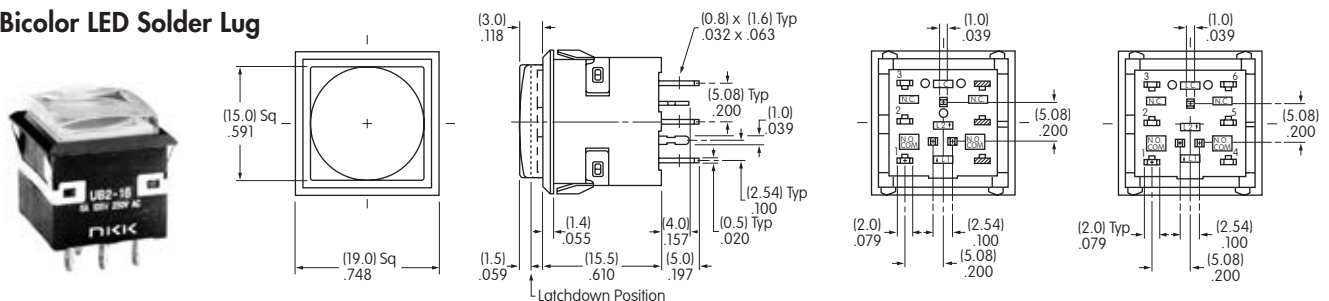

**UB216KKW01CF-1JB**

Bicolor LED Side View

Single Pole

Double Pole

## OPTIONAL ACCESSORIES

### Protective Guard for Snap-in Model

#### AT4141

Opens 90°  
Closes manually



#### Materials:

Cover: Clear Polycarbonate  
Base: Black GFR Polyamide

**Recommended Panel Thickness:**  
.039" ~ .106" (1.0mm ~ 2.7mm)

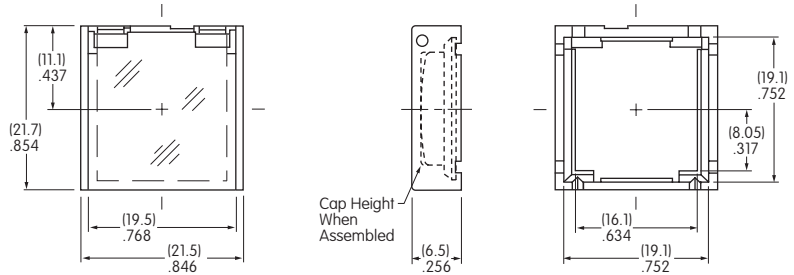

### Spring Loaded Protective Guard for Snap-in Mounting of PCB Model

#### AT4170

Opens 180°  
Closes automatically



#### Materials:

Cover: Clear Polycarbonate  
Base: Black Polyamide  
Coil Spring: Stainless Steel

**Recommended Panel Thickness:**  
.039" ~ .126"  
(1.0mm ~ 3.2mm)

**Recommended Panel-to-PCB Range:**  
.531" (13.5mm)

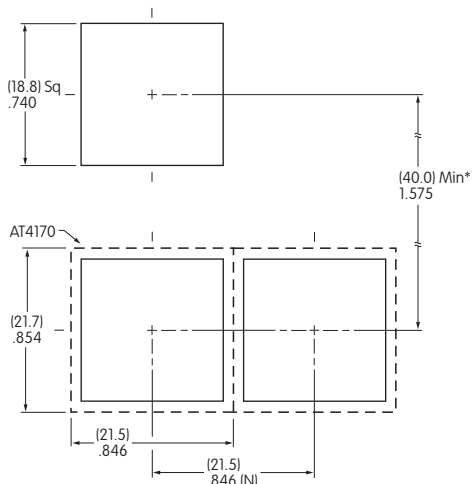
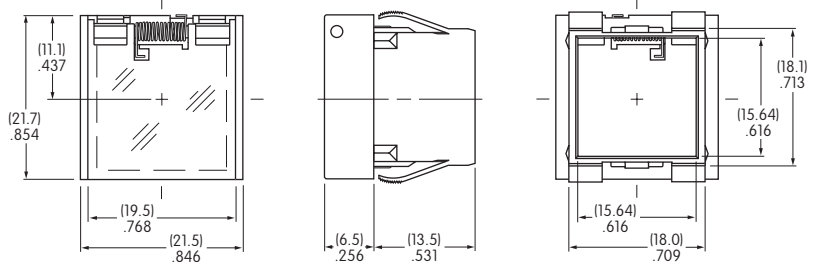

\* Minimum dimension allows opening of cover to 180°

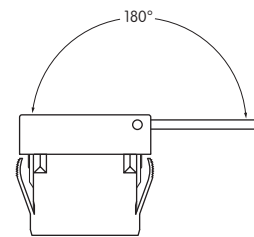
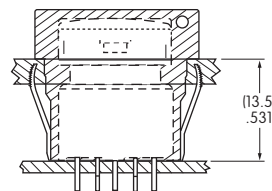

#### Installation

- 1 Install switch onto PC board.
- 2 Snap protective guard into panel.
- 3 Join the two assemblies.

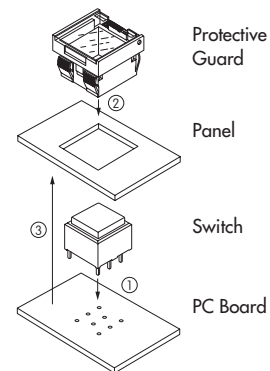

## OPTIONAL ACCESSORIES

### Spring Loaded Protective Guard for Snap-in Model

#### AT4142

Opens 180°  
Closes automatically



#### Materials:

Cover: Clear Polycarbonate  
Base: Black GFR Polyamide  
Coil Spring: Stainless Steel

#### Recommended Panel Thickness:

.039" ~ .106" (1.0mm ~ 2.7mm)

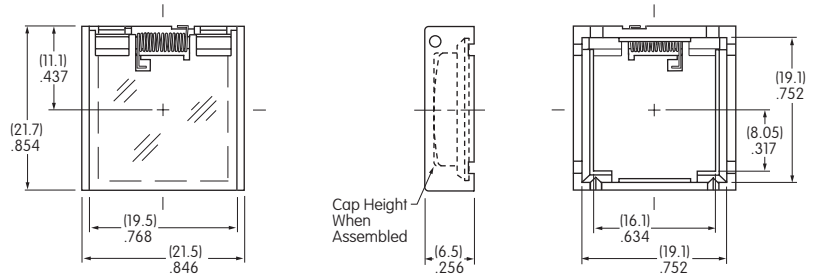

### Dust Cover

AT4145 Not for use with barriers.

#### Materials:

Lid: Clear PVC  
Operating temperature range:  
0°C ~ +70°C (32°F ~ 158°C).  
Gasket: Polyethylene

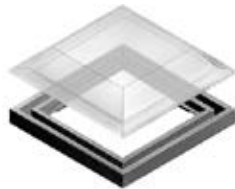

#### Recommended Panel Thickness

.039" ~ .098" (1.0mm ~ 2.5mm)

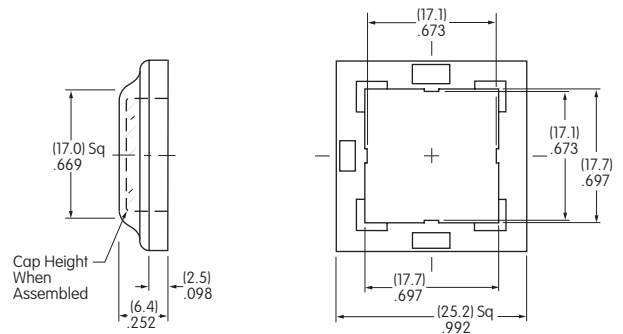

### Barriers for Snap-in Mount

#### AT4143 End

#### AT4144 Center

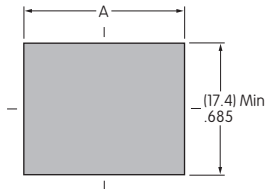
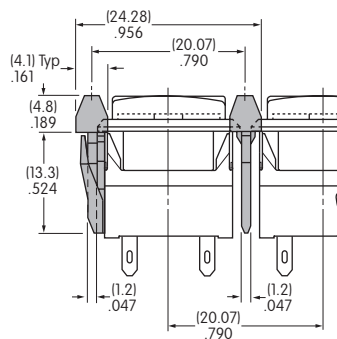
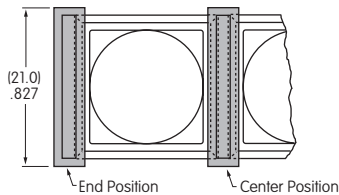

Cutouts for more than 1 Switch:

$$A = .799" (20.3\text{mm}) \times \text{Number of Switches} + .063" (1.6\text{mm})$$

Material: Polyamide

LEGENDS

NKK Switches can provide custom legends for caps. Contact factory for more information.

Suggested Printable Area for UB2 Lens, Film Insert or Diffuser

Recommended Methods: Laser Etch on clear lens, Screen Print or Pad Print on lens;  
Laser Print on film insert.

Shaded areas are printable areas.

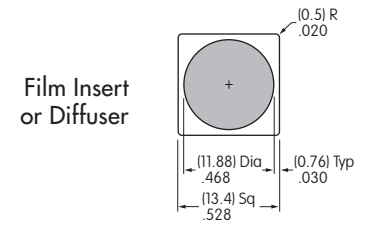
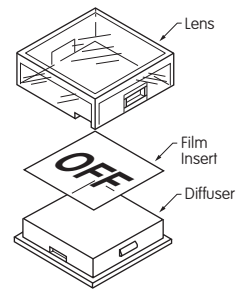
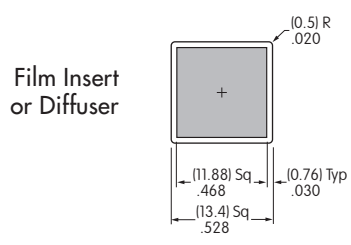
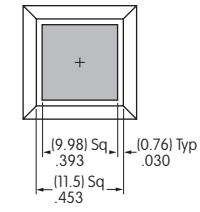
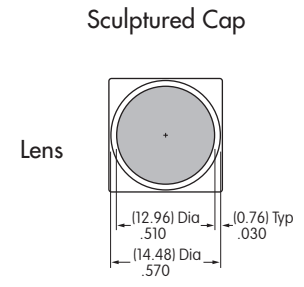
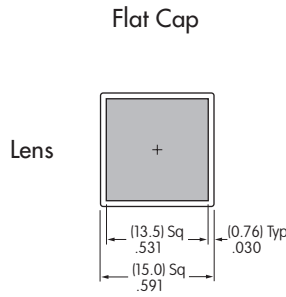
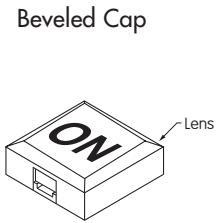

Film Insert: Clear Polyester 4 mil maximum thickness

- Toggles
- Rockers
- Pushbuttons
- D** Illuminated PB
- Programmable
- Keylocks
- Rotaries
- Slides
- Tactiles
- Tilt
- Touch
- Indicators
- Accessories
- Supplement

## X-ON Electronics

Largest Supplier of Electrical and Electronic Components

*Click to view similar products for [Illuminated Pushbutton Switches](#) category:*

*Click to view products by [NKK Switches](#) manufacturer:*

Other Similar products are found below :

[95-313.000](#) [95-414.000](#) [95-900.005](#) [PV3H2B0NN-341](#) [A165L-AGA-T1-2](#) [A30NZ-MNM-TGA](#) [A3AA-91K1-00EG](#) [A3PA-5702-24E](#) [A3U-TMW-A2C-5M](#) [14-030.005](#) [14-271.025](#) [14-132.025](#) [MS3470L22-55SZ L/C](#) [18-257.035](#) [18-287.035](#) [19-050.005](#) [19-139.035](#) [19-471.035](#) [22-212.011](#) [22-223.011](#) [95-900.009](#) [A017101](#) [A165L-JRM-T1-2](#) [A30NZ-MNM-TYA](#) [A3AT-90K1-00EG](#) [A3AT-90K1-00ER](#) [A3PA-5701-12E](#) [A3SA-90D1-28W](#) [18-187.035](#) [19-031.005](#) [22-225.011](#) [31-426.036](#) [31-455.036](#) [31-463.036](#) [3FTH98020](#) [51-131.022](#) [31-051.006](#) [IPR3SAD2LSG](#) [41-461.036](#) [51-265.0](#) [51-455.036](#) [51-463.036](#) [02-617.011](#) [02-618.011](#) [02-616.011](#) [03-619.011](#) [03-624.011](#) [11-271.825](#) [11-131.825](#) [11-433.836](#)