

DESCRIPTION: HIGH DENSITY FEMALE - VERTICAL DIP SOLDER

DIMENSIONS

Insulator Material	No. OF PINS	A	B	C	D	E	F	G	H
PA9T	15	1.213	0.984	0.643	0.311	0.090	0.756	0.496	0.429
		30.80	24.99	16.34	7.90	2.29	19.20	12.60	10.90
PA9T	26	1.543	1.312	0.972	0.311	0.090	1.091	0.496	0.429
		39.20	33.32	24.70	7.90	2.29	27.70	12.60	10.90
PA9T	44	2.087	1.852	1.512	0.311	0.090	1.618	0.496	0.429
		53.00	47.04	38.40	7.90	2.29	41.10	12.60	10.90
PA6T	62	2.732	2.500	2.157	0.311	0.095	2.256	0.496	0.429
		69.40	63.50	54.80	7.90	2.41	57.30	12.60	10.90
PA6T	78	2.638	2.406	2.055	0.429	0.095	2.169	0.606	0.526
		67.00	61.10	52.20	10.90	2.41	55.10	15.40	13.35

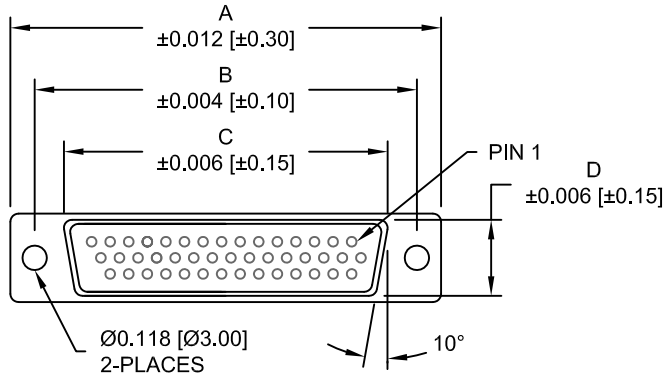

4 ROWS

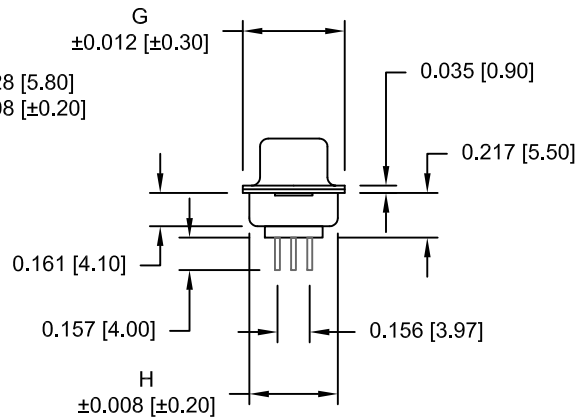
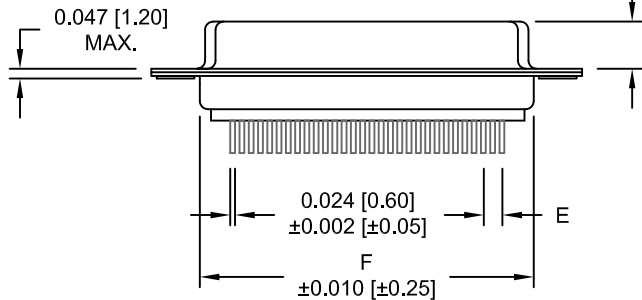

180-YYY-213RYY1

- SERIES
- POSITIONS
  - 015
  - 026
  - 044
  - 062
  - 078
- GENDER
  - 2 = FEMALE
- TERMINATION
  - 1 = VERTICAL DIP SOLDER
- SHELL PLATING
  - 2 = TIN
  - 3 = NICKEL
- RoHS COMPLIANT (260°C)
- HARDWARE OPTIONS
  - 00 = NO HARDWARE
  - 01 = .098" CLINCH NUT (BOARD SIDE)
  - 02 = .236" CLINCH NUT (BOARD SIDE)
  - 03 = .236" CLINCH NUT (MATING SIDE)
  - 05 = .237" 4-40 BOARD LOCK
  - 08 = .224" 4-40 BOARD LOCK
  - 90 = .237" 4-40 BOARD LOCK
  - FOR 0.093" BOARD MAX.
  - 91 = .237" 4-40 SPACER/BOARD LOCK
  - 92 = .237" 4-40 SPACER/BOARD LOCK
  - FOR 0.093" BOARD MAX.
- PLATING OPTIONS
  - 1 = GOLD FLASH
  - A = 30u" GOLD MATING AREA, GOLD FLASH OVERALL

MATERIAL:

- SHELL: STEEL, NICKEL PLATED
- INSULATOR: GLASS FILLED THERMOPLASTIC, UL 94V-O RATED
- CONTACT: BRASS, GOLD PLATED OVER NICKEL

ELECTRICAL:

- CURRENT RATING: 3 AMPS
- CONTACT RESISTANCE: 15 mOhms Max.
- INSULATION RESISTANCE: 1,000 MOhms min.
- VOLTAGE: 500VAC FOR 1 MINUTE
- TEMPERATURE: -50° C TO 100° C

DO NOT SCALE FROM DRAWING

RoHS COMPLIANT

	THESE DRAWINGS AND SPECIFICATIONS ARE THE PROPERTY OF NorComp AND SHALL NOT BE REPRODUCED, COPIED OR USED AS THE BASIS FOR THE MANUFACTURE OF SALE OF APPARATUS WITHOUT WRITTEN PERMISSION.	DRAWN: PAM JENKINS	DATE: 09-12-05
	<h1>NorComp</h1>	SCALE: NTS	SHEET OF 1 3
		DWG NO. 180-YYY-213RYY1	

DESCRIPTION: PCB LAYOUT - VERTICAL - FEMALE

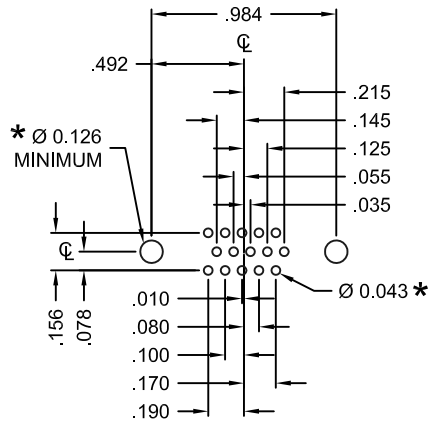

15 POSITION

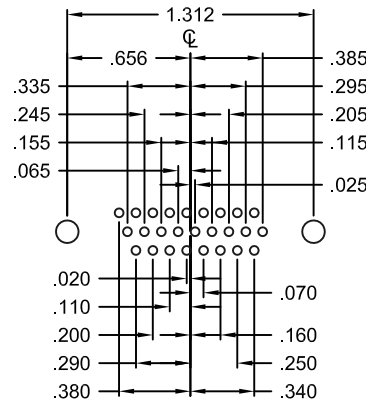

26 POSITION

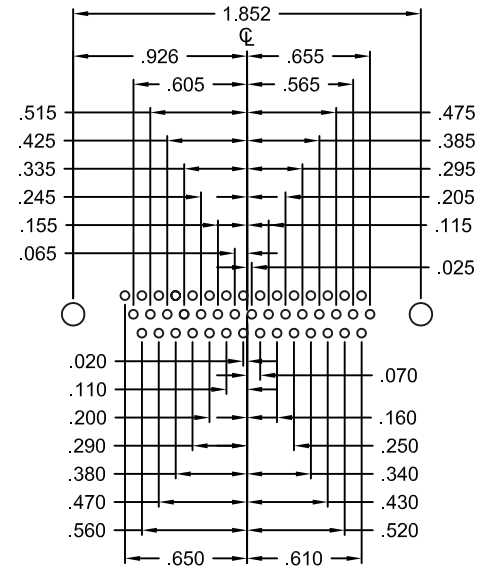

44 POSITION

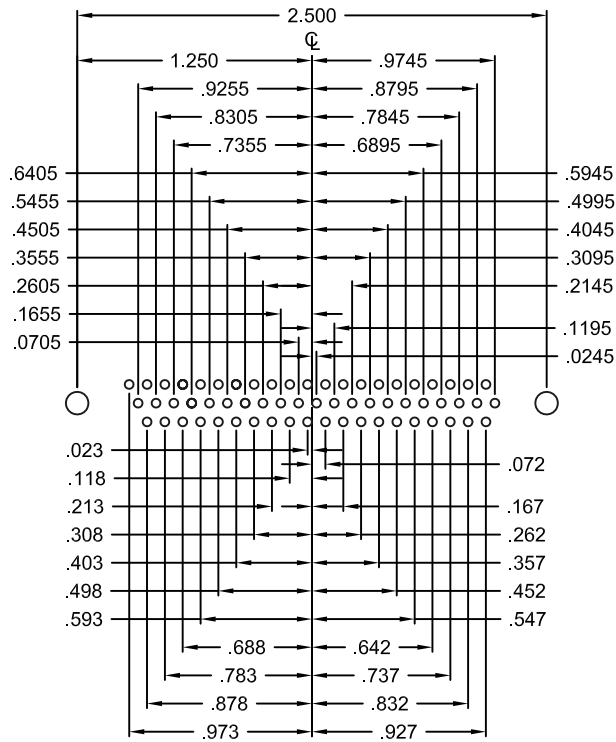

62 POSITION

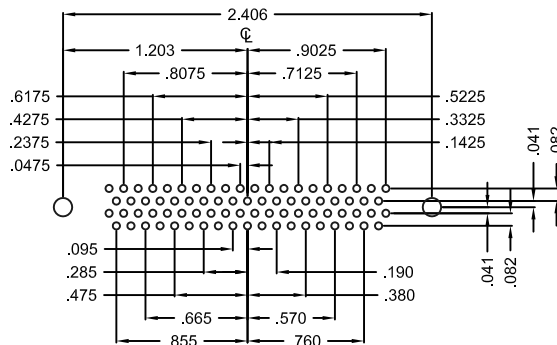

78 POSITION

HOLE PATTERN SHOWN ARE FOR FEMALE

UNITS = inch

\* TYP. SUGGESTED SIZE MAY NOT BE SUITABLE FOR ALL APPLICATIONS

DO NOT SCALE FROM DRAWING

	THESE DRAWINGS AND SPECIFICATIONS ARE THE PROPERTY OF NorComp AND SHALL NOT BE REPRODUCED, COPIED OR USED AS THE BASIS FOR THE MANUFACTURE OF SALE OF APPARATUS WITHOUT WRITTEN PERMISSION.		DRAWN: PAM JENKINS	DATE: 09-12-05
	NorComp		SCALE: NTS	SHEET 2 OF 3
DWG NO. 180-YYY-213RYY1				

DESCRIPTION: CLINCH NUT HARDWARE

ALL CLINCH-NUTS ARE 4-40 INTERNAL THREADS

TOLERANCE:

ALL DIMENSIONS ARE  $\pm 0.010$

01X ..... 0.098" (BOARD SIDE)

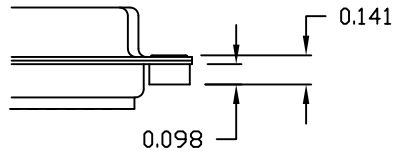

02X ..... 0.236" (BOARD SIDE)

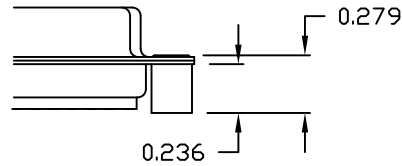

03X..... 0.236" (MATING SIDE)

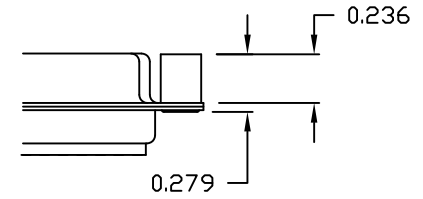

05X ..... 0.237" (BOARD SIDE)

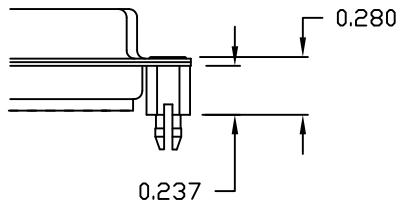

08X ..... 0.228" (BOARD SIDE)

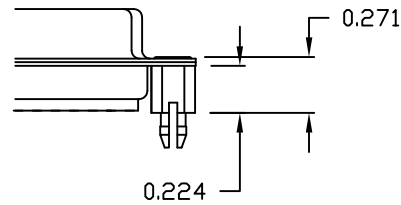

91X ..... 0.237" BOARD SIDE  
0.197 MATING SIDE

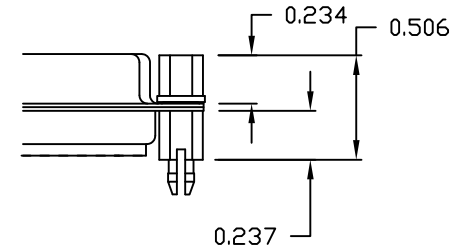

NOTE: 4-40 FEMALE SCREW LOCK IS REMOVABLE

90X ..... 0.237" (BOARD SIDE)

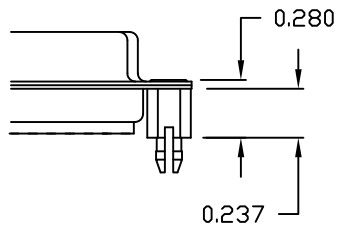

92X ..... 0.237" BOARD SIDE  
0.197 MATING SIDE

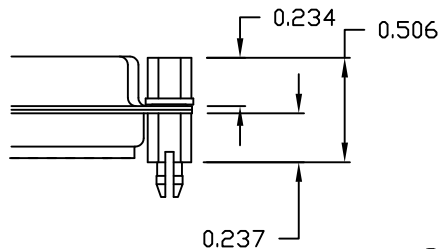

NOTE: 4-40 FEMALE SCREW LOCK IS REMOVABLE

NOTE: 90 & 92 OPTION FOR 0.093" MAX. BOARD THICKNESS

DO NOT SCALE FROM DRAWING

RoHS COMPLIANT



THESE DRAWINGS AND SPECIFICATIONS ARE THE PROPERTY OF NorComp AND SHALL NOT BE REPRODUCED, COPIED OR USED AS THE BASIS FOR THE MANUFACTURE OF SALE OF APPARATUS WITHOUT WRITTEN PERMISSION.

NorComp

DRAWN: PAM JENKINS		DATE: 09-12-05	
SCALE: NTS	SHEET 3	OF 3	REV 22
DWG NO. 180-YYY-213RYY1			

## X-ON Electronics

Largest Supplier of Electrical and Electronic Components

*Click to view similar products for [D-Sub High Density Connectors](#) category:*

*Click to view products by [NorComp](#) manufacturer:*

Other Similar products are found below :

[97-3250-11](#) [163A16809X](#) [163A17089X](#) [164A17199X](#) [242A25680X](#) [L717HDB44POL2R210](#) [L717HDEH15POL2](#) [L777HDE15P](#)  
[L77HDE15SC309](#) [163A16759X](#) [163A16839X](#) [163A16989X](#) [163A17079X](#) [164A17329X](#) [164A18219X](#) [241A16440X](#) [241A16550X](#)  
[241A16680X](#) [241A20810X](#) [241A25740X](#) [CT25-44P](#) [MDBE15PE766](#) [L177HDE15SOL2RM23](#) [L177HRC62S](#) [L177HRC62SVFM](#)  
[L177HRCG62S](#) [L717HDEG15POL2RM5](#) [L77HDA26SVF](#) [L77HDE15SD1CO](#) [L77HDEH15SOL2RM832](#) [443895-3](#) [106698-1](#) [280-012K2C](#)  
[L177HRB44S](#) [164A17039X](#) [09562004701510](#) [164A17969X](#) [L777HRC62P](#) [241A17960X](#) [164A18269X](#) [280-019S1S9MEN](#) [L777HDEG15P](#)  
[280-018P3S25MEGN](#) [206504-2](#) [40-9515HDSP](#) [2057140-1](#) [C115370-6002](#) [DFMA104SNMBFR172FR022](#) [HDC9F200E2S](#) [M24308/4-265](#)