

SPECIFICATIONS:

ELECTRICAL:

INSULATOR RESISTANCE: 5 G OHMS Min.
 DIELECTRIC WITHSTANDING: 1,000VAC r.m.s.
 OPERATING TEMPERATURE: -55° C ~ +125° C
 POWER CONTACT RESISTANCE: 1.0 mOHMS Max.
 SIGNAL CONTACT RESISTANCE: 2.7 mOHMS Max.
 POWER PINS: SEE PART NUMBER BELOW
 SIGNAL PINS: 5 AMPS

MECHANICAL:

CONTACT INSERTION FORCE: 4.5 Kg Max.
 CONTACT SEPARATOR FORCE: 0.3Kg Min.

MATERIALS:

CONTACTS: COPPER ALLOY
 INSULATOR: PBT UL94V-0 RATED, BLK
 230°C PROCESS TEMP.

SHELL:

STEEL
 F08 FLEXIBLE ADHESIVE

FINISH:

SHELL: NICKEL
 CONTACTS: FULL GOLD FLASH

680S21W1103LYY1

2 = 20 AMP
 4 = 40 AMP
 0 = NO HARDWARE
 1 = 0.098" CN TERMINATION SIDE
 1 = GOLD FLASH
 *CONTACT NORCOMP FOR MORE OPTIONS

MEETS IP67 STANDARDS

(SEE PAGE 2 FOR SEALING DETAILS)

RoHS COMPLIANT

UNITS = inch [mm]

DO NOT SCALE FROM DRAWING



THESE DRAWINGS AND SPECIFICATIONS ARE THE PROPERTY OF NorComp AND SHALL NOT BE REPRODUCED, COPIED OR USED AS THE BASIS FOR THE MANUFACTURE OR SALE OF APPARATUS WITHOUT WRITTEN PERMISSION.

DRAWN: M. SIGMON
 DATE: 06/11/2013

NorComp

SCALE: NTS	SHEET 1	OF 2	REV 2
DWG NO.		680S21W1103LYY1	

HARDWARE OPTIONS
CLINCH NUTS HAVE #4-40 INTERNAL THREADS THRU

0 NO HARDWARE

1 0.098" TERMINATION SIDE

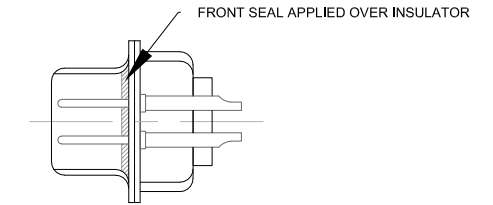
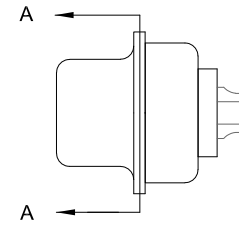
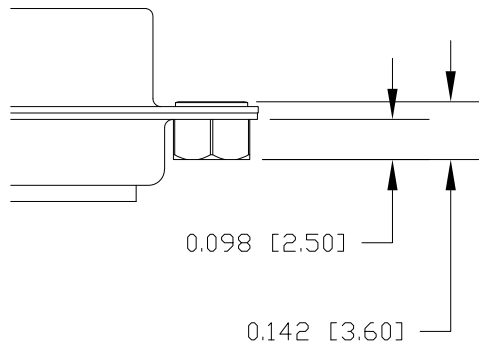
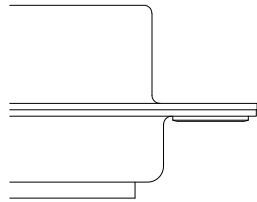

DETAIL A-A
 SHOWN FOR REFERENCE ONLY

NOTE:
SIGNAL AND POWER CONTACTS
COME PRE-LOADED INTO INSULATORS

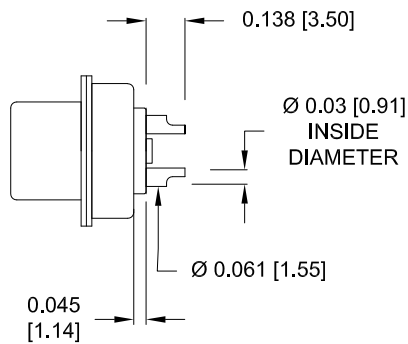

SIGNAL CONTACTS
 ACCEPTS UP TO 20 AWG WIRE

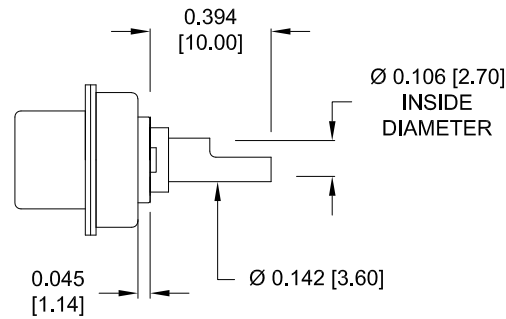

20 AMP POWER CONTACTS
 ACCEPTS UP TO 12 AWG WIRE

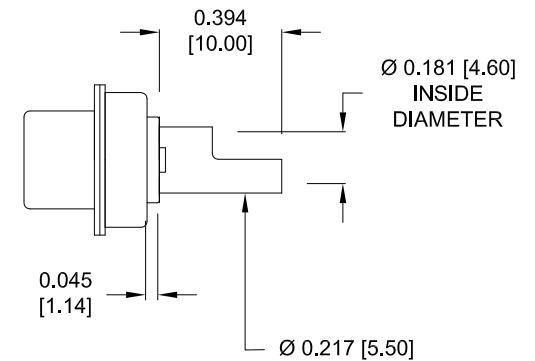

40 AMP POWER CONTACTS
 ACCEPTS UP TO 8 AWG WIRE

RoHS COMPLIANT

UNITS = inch [mm]

DO NOT SCALE FROM DRAWING



THESE DRAWINGS AND SPECIFICATIONS ARE THE PROPERTY OF NorComp AND SHALL NOT BE REPRODUCED, COPIED OR USED AS THE BASIS FOR THE MANUFACTURE OR SALE OF APPARATUS WITHOUT WRITTEN PERMISSION.

DRAWN:
M. SIGMON

DATE:
 06/11/2013

NorComp

SCALE:
 NTS

SHEET OF
 2 OF 2

REV
 2

DWG NO.

680S21W1103LYY1

X-ON Electronics

Largest Supplier of Electrical and Electronic Components

Click to view similar products for [D-Sub Mixed Contact Connectors](#) category:

Click to view products by [NorComp](#) manufacturer:

Other Similar products are found below :

[790-025SF-5P5NMN](#) [790-025SJ-7P7NML](#) [DAM-7W2PC](#) [L717TWB5W5P3R](#) [L717TWB5W5PRM84](#) [L717TWP3W3P](#)
[3003W3PXX56N40X](#) [3005W5PXX99E40X](#) [3005W5SXX99A30X](#) [3005W5SXX99E40X](#) [3013W6SCM99A10X](#) [3036W4PCM41A10X](#)
[3036W4SCM99A10X](#) [FCE17-E2W2SS-2N0](#) [212522-7](#) [3003W3PXX43A10X](#) [3003W3SXX56N40X](#) [3005W5PXX88N40X](#)
[3008W8SXX57A30X](#) [3009W4PCT57P20X](#) [3011W1SXX99A10X](#) [3017W2SAR69C40X](#) [321WA4PXK99A60X](#) [3F3SSC22S41A30X](#)
[L717TWA7W2PP2SY3R](#) [DBM-17W2S-1A8N-A190-A197-1](#) [421WA4PCR50E20X](#) [09691009009](#) [09691100022500](#) [09693009176](#)
[09692009147](#) [09693909015](#) [6017W2PCM41B30X](#) [790-061SH-36W2NMNA](#) [790-044SE-7P3MNPB](#) [790-043PE-11P2MPA](#) [790-043PB-](#)
[2P2MPB](#) [790-029SB-2P2MEPA](#) [790-028PK-9P9MPA](#) [790-028PH-54P2MGA](#) [790-028PH-36P2MNA](#) [790-028PB-2P2MPA](#) [790-027SH-](#)
[5W5MTEP](#) [790-026PH-54P2ZNUG](#) [790-026PH-54P2MP](#) [790-026PH-36P2ZNUG](#) [790-026PH-36P2MG](#) [790-026PD-3P3MP](#) [790-025SJ-](#)
[7P7EMS](#) [790-025SH-36W2NMT](#)