

NUT

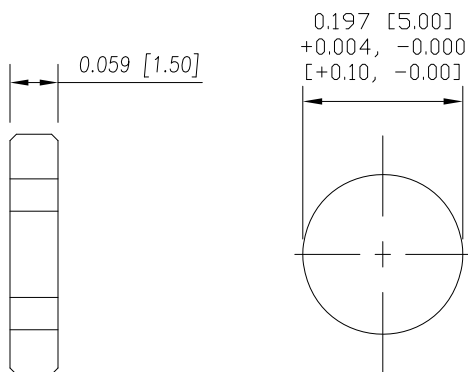

RECOMMEND PANEL CUT-OUT
MAX. PANEL THICKNESS: 0.200" [5.08]

NOTE:

MATERIAL

HOUSING: PBT UL94V-0, BLACK
CONTACT: BRASS
NUT: BRASS
SHELL: BRASS
O-RING: NBR, BLACK

FINISH

CONTACT: GOLD PLATED
OVER 50µ" NICKEL
NUT: NICKEL PLATED
SHELL: NICKEL PLATED

ELECTRICAL

RATED CURRENT: 1A
RATED VOLTAGE: 60V
INSULATION RESISTANCE: 100 MΩhms MIN.
CONTACT RESISTANCE: 10 mΩhms MAX.
WATER PROOF: IP67

ENVIRONMENT

OPERATION TEMPERATURE: -40°C TO +85°C
WIRE GAUGE: 28 AWG MAX RECOMMENDED

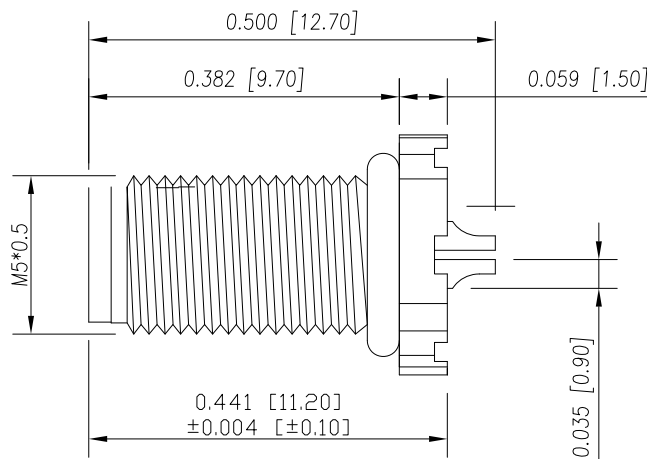
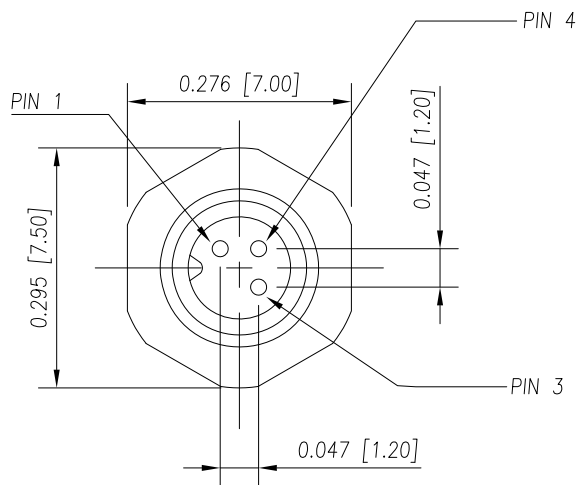

851-003-103R00Y

1 = GOLD FLASH
4 = 10µ" GOLD

RoHS COMPLIANT

UNITS = INCHES [MM]

DO NOT SCALE FROM DRAWING



THESE DRAWINGS AND SPECIFICATIONS ARE THE PROPERTY OF NorComp AND SHALL NOT BE REPRODUCED, COPIED OR USED AS THE BASIS FOR THE MANUFACTURE OR SALE OF APPARATUS WITHOUT WRITTEN PERMISSION.

DRAWN:

M. SIGMON

DATE:

03-04-16

NorComp

SCALE:
NTS

SHEET OF
1 1

REV
5

DWG NO.

851-003-103R00Y

X-ON Electronics

Largest Supplier of Electrical and Electronic Components

Click to view similar products for [Circular Metric Connectors](#) category:

Click to view products by [NorComp](#) manufacturer:

Other Similar products are found below :

[600X518037X](#) [6STD15PCR99B70A](#) [8R4000A16M020](#) [8R5000A16M005](#) [1200910002](#) [1203580030](#) [1200910008](#) [1200910011](#) [1300140094](#)
[130203-0054](#) [1300140026](#) [1300150099](#) [RF-12S1N8A90DU](#) [1-3637-600-5205](#) [1612618](#) [21036836414](#) [8R4006A16M010](#) [1604232](#)
[1R3006A20M005](#) [RF-12P1N8A90DU](#) [41-40011](#) [42-00006](#) [42-01015](#) [4-22279-4](#) [4-22281-1](#) [4-22284-9](#) [43-00113](#) [43-01088](#) [43-01203](#) [41-](#)
[40013](#) [42-00008](#) [43-00343](#) [43-01026](#) [43-01162](#) [43-01173](#) [43-10000](#) [XS3P-M421-2](#) [600X518050X](#) [SACC-DSI-FS-5P-PG9-L180 SC](#)
[8R5006A16M020](#) [8R5006A16M005](#) [8R4000A16M010](#) [6-22279-3](#) [1605332](#) [N03FA03144](#) [1300140077](#) [43-16213](#) [43-01338](#) [XS2RD4265](#)
[XS2R-D426-1](#)