

DESCRIPTION: SCSI 2 & 3 DIE CAST WITH THUMBSCREWS

DIMENSIONS					
No. OF PINS	A	B	C	D	E
50	1.252 [31.80]	2.98 [53.30]	0.461 [11.70]	0.535 [13.60]	1.520 [38.60]
68	1.673 [42.50]	2.516 [63.90]	0.465 [11.80]	0.543 [13.80]	1.508 [38.30]
ALL TOLERANCES = 0.012 [0.30]					

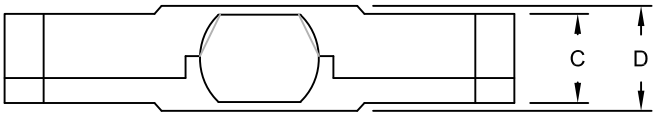

MATERIAL:

- BACK SHELL: ZINC PLATED NICKEL OVER COPPER
- JACKSCREWS: STEEL, NICKEL PLATED OVER COPPER
- SCREWS: STEEL, NICKEL PLATED OVER COPPER
- CLAMP: STEEL, NICKEL PLATED

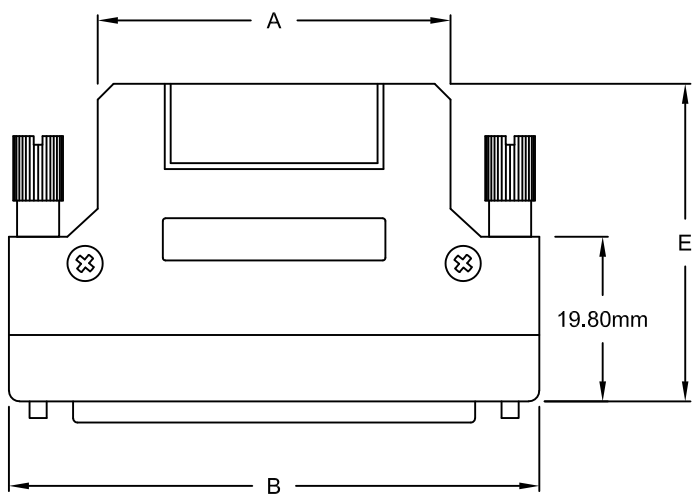

- KIT INCLUDES:**
- (1) MALE CONNECTOR - SOLDER CUP
 - (2) METAL SHELL HALVES
 - (2) THUMBSCREWS (2-56 THREADS)
 - (1) STRAIN RELIEF CLAMP
 - (2) STRAIN RELIEF SCREWS
 - (2) HOUSING SCREWS

**BACK SHELL KIT
PART NUMBER
989-YYY-130L121**

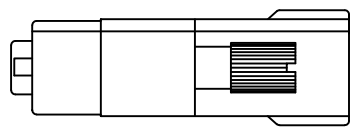
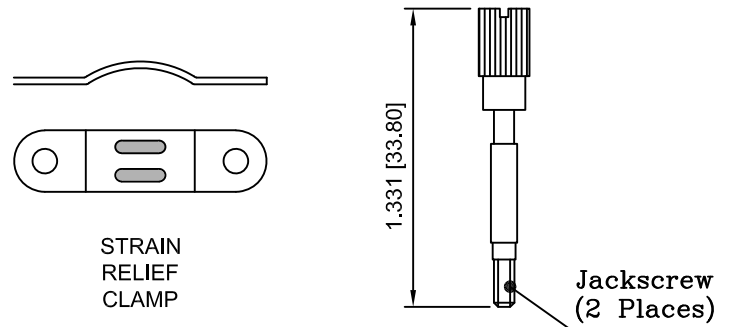
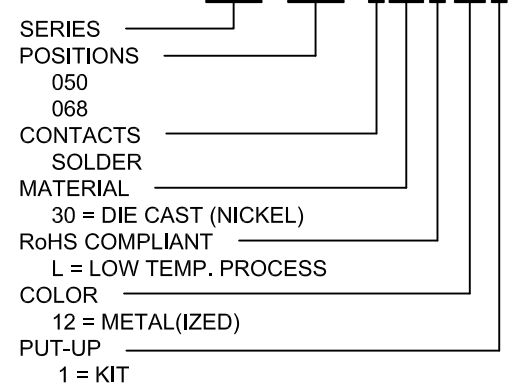

RoHS COMPLIANT

UNITS = INCHES [MM] **DO NOT SCALE FROM DRAWING**

	THESE DRAWINGS AND SPECIFICATIONS ARE THE PROPERTY OF NorComp AND SHALL NOT BE REPRODUCED, COPIED OR USED AS THE BASIS FOR THE MANUFACTURE OR SALE OF APPARATUS WITHOUT WRITTEN PERMISSION.	DRAWN: N. KOVALSKY
		DATE: 04/18/2008

NorComp

SCALE: NTS	SHEET 1	OF 3	REV 3
DWG NO. 989-YYY-130L121			

DESCRIPTION: CONNECTOR FOR 988 SERIES BACK SHELL KIT

No. OF PINS	DIMENSIONS		
	A	B	C
50	1.545 [39.30]	1.372 [34.85]	0.366 [9.30]
68	1.996 [50.70]	1.825 [46.35]	0.366 [9.30]

MATERIAL:

HOUSING: THREMOPLASTIC, BLACK, P.B.T. UL94V-0
 CONTACTS: PHOSPHOR BRONZE, 5u" GOLD MATING AREA
 FRONT SHELL: STEEL, NICKEL PLATED OVER COPPER

ELECTRICAL:

CURRENT RATING: 0.5 AMPS
 INSULATOR RESISTANCE: 500 MOHMS Min.
 DIELECTRIC WITHSTANDING: 500VAC
 CONTACT RESISTANCE: 35 mOhms Max.
 OPERATING TEMPERATURE: -55° ~ +85° C

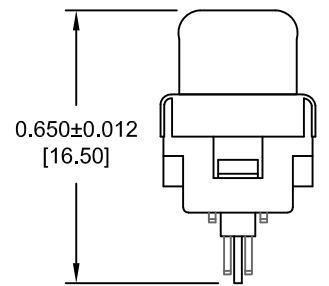
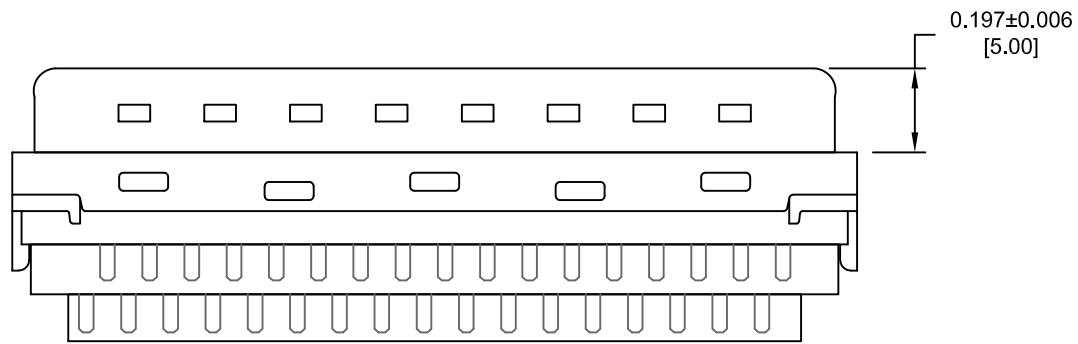
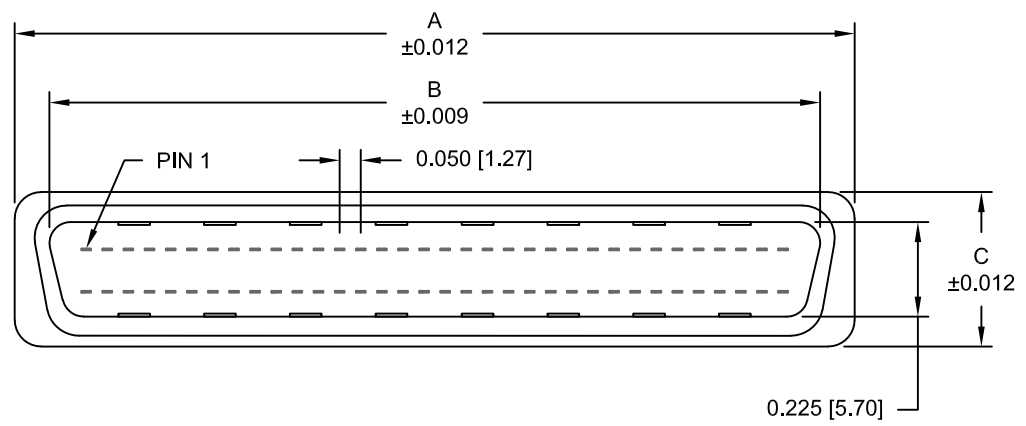

RoHS COMPLIANT

UNITS = INCHES [MM] DO NOT SCALE FROM DRAWING

	THESE DRAWINGS AND SPECIFICATIONS ARE THE PROPERTY OF NorComp AND SHALL NOT BE REPRODUCED, COPIED OR USED AS THE BASIS FOR THE MANUFACTURE OR SALE OF APPARATUS WITHOUT WRITTEN PERMISSION.	DRAWN: N. KOVALSKY
		DATE: 04/18/2008

NorComp

SCALE: NTS	SHEET 2	OF 3	REV 3
DWG NO. 989-YYY-130L121			

50 POSITION

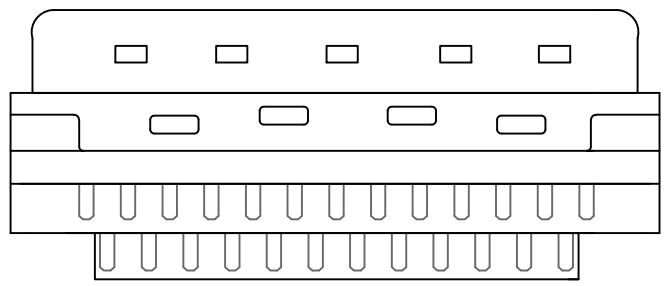
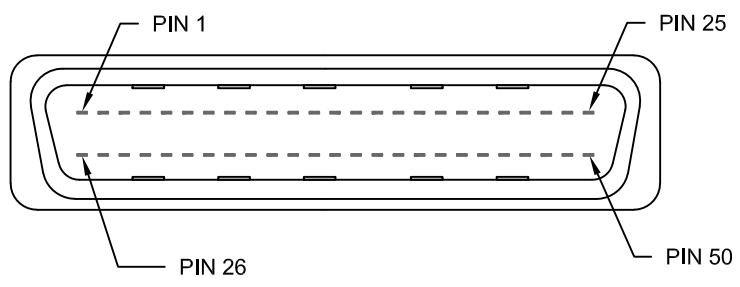

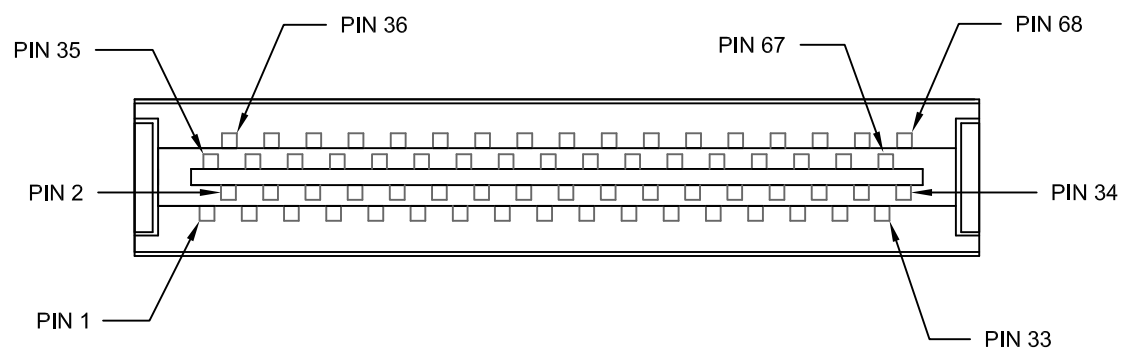
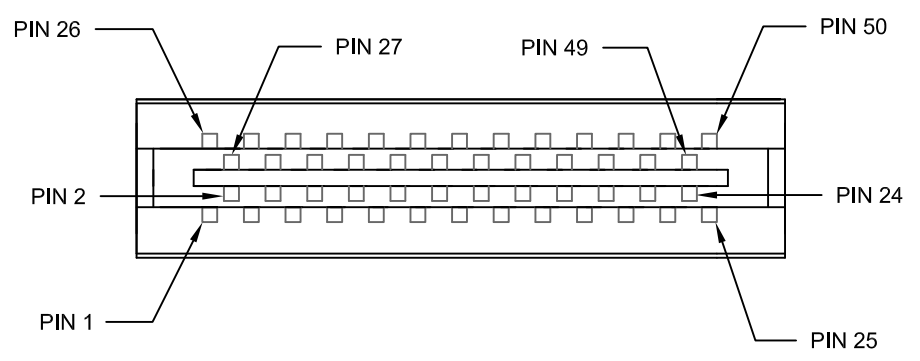
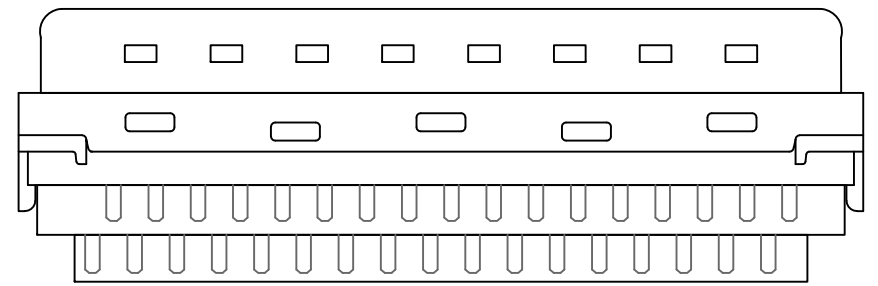
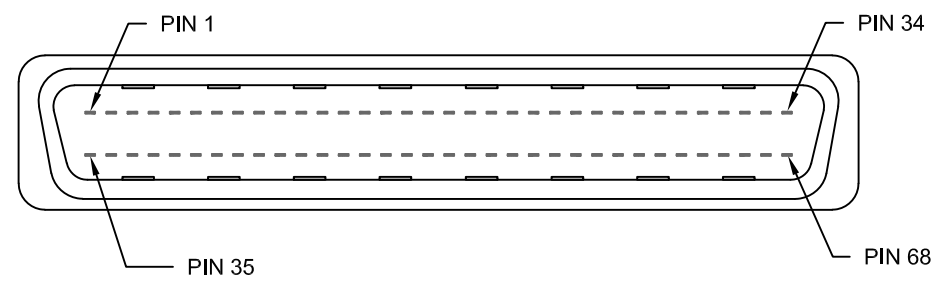

68 POSITION



RoHS COMPLIANT

UNITS = INCHES [MM] DO NOT SCALE FROM DRAWING

	THESE DRAWINGS AND SPECIFICATIONS ARE THE PROPERTY OF NorComp AND SHALL NOT BE REPRODUCED, COPIED OR USED AS THE BASIS FOR THE MANUFACTURE OR SALE OF APPARATUS WITHOUT WRITTEN PERMISSION.	DRAWN: N. KOVALSKY
		DATE: 04/18/2008

	SCALE: NTS	SHEET OF 3 3	REV 3
	DWG NO. 989-YYY-130L121		

X-ON Electronics

Largest Supplier of Electrical and Electronic Components

Click to view similar products for [D-Sub High Density Connectors](#) category:

Click to view products by [NorComp](#) manufacturer:

Other Similar products are found below :

[97-3250-11](#) [164A05929A](#) [164A17479X](#) [164A18209X](#) [L717HDB44POL2R210](#) [L777HDE15P](#) [163A17049X](#) [164A17309X](#) [164A18219X](#)
[241A16440X](#) [241A16550X](#) [241A16680X](#) [241A20810X](#) [241A25740X](#) [242A18280X](#) [MDBE15PE766](#) [L177HRC62S](#) [L177HRC62SVFM](#)
[L177HRCG62S](#) [L77HDA26SVF](#) [L77HDEH15S](#) [DAMA-15S-WS](#) [DAMA26PM](#) [443895-3](#) [4HDD44SCY99R40X](#) [106698-1](#)
[DAMA15SA183F0](#) [DAMA26PNMF0](#) [DAMA15SNM-F0](#) [L177HRB44S](#) [09562004701510](#) [L777HRC62P](#) [164A18269X](#) [DAMA26SNMF0](#)
[206504-2](#) [2057140-1](#) [DFMA104SNMBFR172FR022](#) [L717HDAG26POL2RM8](#) [241A28180X](#) [164A20979X](#) [280-019S1S9MEL](#) [280-](#)
[029S2S15MEPB](#) [280-023S1S9MTPA](#) [280-022P5H78MTGPA](#) [242A19620X](#) [241A26740X](#) [L177HDEH15SOL2RM5](#) [280-047S4-27W2MEN](#)
[L717HDA26PD1CH4R](#) [280-019S1H15MEN](#)