

18D - ATEX

Electro-mechanical pneumatic pressure switches

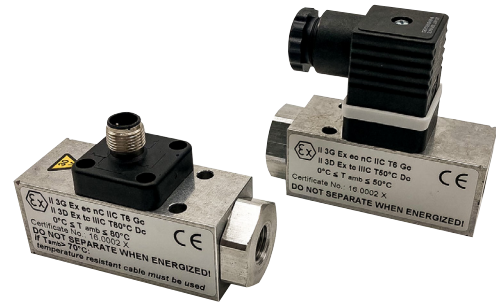

- > -1 ... 30 bar
Port size: G1/4 or flange
 - > Microswitch with gold plated contacts
 - > Vibration resistant to 15 g
 - > Microswitch approved by UL and CSA
 - > Intrinsically safe operation
- > For Ex applications conforming to ATEX: Zone 2 category ATEX 3G (gases): Ex ec nC IIC T6 Gc
Zone 22 category ATEX 3D (dusts): Versions, form A connector: Ex tc IIIC T50 °C Dc; Versions, M12x1 connector: Ex tc IIIC T80 °C Dc
Special condition to be observed during the installation



Technical features

Medium:
For neutral, gaseous and liquid fluids

Operation:
Diaphragm

Operating pressure:
-1 ... 30 bar (-14 ... 435 psi)

Maximum over pressure:
80 bar (1160 psi)

Repeatability:
±3% for vacuum; ±4% of final value (depending on regulating pressure)

Port size:
G1/4 or flange

Media viscosity:
Up to 1000 mm²/s

Switching pressure difference/hysteresis:
Fixed

Switching cycles:
100 1/min

Life cycle of mechanical parts:
10⁷ switching cycles

Switching element:
Microswitch with gold plated contacts

Mounting position:
Optional

Degree of protection:
IP65 for DIN EN 175301-803 (DIN 43650) form A connection
IP67 for M12x1 connection

Electrical connection:
DIN EN 175301-803 (DIN 43650) form A or M12x1 IEC 947-5-2

Weight:
0,2 kg (0.44 lbs)

Ambient/Media temperature:
Versions, form A connector:
0 ... +50°C (32 ... +122°F)
Versions, M12x1 Connector:
0 ... +80°C (32 ... +176°F)
Air supply must be dry enough to avoid ice formation at temperatures below +2°C (+35°F)

Materials:
Housing: Aluminium
Sealing: FPM/brass
O-ring: NBR

Technical data

Electrical connection acc. to DIN EN 175301-803, form A

Symbol	Port size	Pressure range *1)		Switching pressure difference				Materials press sensor		Drawing No.	Model
		(bar)	(psi)	Lower range (bar)	Lower range (psi)	Upper range (bar)	Upper range (psi)	Body	Seal		
	G1/4	-1 ... 0	-14 ... 0	0,15	2,17	0,18	2,61	AL	FPM/MS/NBR	1	0880180
	G1/4	0,2 ... 2	2,9 ... 29	0,20	2,9	0,35	5,07	AL	FPM/MS/NBR	1	0880280
	Flange	0,2 ... 2	2,9 ... 29	0,20	2,9	0,35	5,07	AL	FPM/MS/NBR	3	0881280
	G1/4	0,5 ... 8	7,2 ... 116	0,35	5,07	0,85	12,3	AL	FPM/MS/NBR	2	0880380
	Flange	0,5 ... 8	7,2 ... 116	0,35	5,07	0,85	12,3	AL	FPM/MS/NBR	3	0881380
	G1/4	1 ... 16	23,2 ... 232	0,40	5,8	1,20	17,4	AL	FPM/MS/NBR	2	0880480
	G1/4	1 ... 30	23,2 ... 435	1,0	14,5	5,00	72,5	AL	FPM/MS/NBR	2	0880680

Electrical connection M12x1 nach IEC 947-5-2 - plug not included, max. allowable voltage 30 V

The pressure switch will loose the Ex approval when using wire sockets other than those listed in the data sheet.

Symbol	Port size	Pressure range *1)		Switching pressure difference				Materials press sensor		Drawing No.	Model
		(bar)	(psi)	Lower range (bar)	(psi)	Upper range (bar)	(psi)	Body	Seal		
	G1/4	-1 ... 0	-14 ... 0	0,15	2,17	0,18	2,61	AL	FPM/MS/NBR	1	0880181
	G1/4	0,2 ... 2	2,9 ... 29	0,20	2,9	0,35	5,07	AL	FPM/MS/NBR	1	0880281
	G1/4	0,5 ... 8	7,2 ... 116	0,35	5,07	0,85	12,3	AL	FPM/MS/NBR	2	0880381
	Flange	0,5 ... 8	7,2 ... 116	0,35	5,07	0,85	12,3	AL	FPM/MS/NBR	3	0881381
	G1/4	1 ... 16	23,2 ... 232	0,40	5,8	1,20	17,4	AL	FPM/MS/NBR	2	0880481
	Flange	1 ... 16	23,2 ... 232	0,40	5,8	1,20	17,4	AL	FPM/MS/NBR	2	0881481

*1) Setpoints should be ideally in the middle of the switching pressure range. Reference pressure = atmospheric pressure. Switching pressure must not exceed the indicated values.

MS = brass

Accessories

Pressure port reducing nipple	Surge damper	Cover	Connector DIN EN 175301-803	Connector M12x1 4-pin, 90°	4-pin, straight
					
Page 3	Page 3	Page 3			
0574767 (brass)	0574773 (brass)	0554737	0524210 (Form A)	0524207 (2 m cable, 4-core)	0524206 (2 m cable, 4-core)
0550083 (stainless steel)	0553258 (stainless steel)			0524209 (5 m cable, 4-core)	0524208 (5 m cable, 4-core)

Switching function

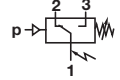
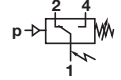
	Connector DIN EN 175301-803, form A Microswitch SPDT Terminals 1 - 3: Contacts close on rising pressure. Terminals 1 - 2: Contacts open on rising pressure.		Connector IEC 947-5-2, M12x1 Microswitch SPDT Terminals 1 - 4: Contacts close on rising pressure. Terminals 1 - 2: Contacts open on rising pressure.
-------------------------------------------------------------------------------------	----------------------------------------------------------------------------------------------------------------------------------------------------------------------------	-------------------------------------------------------------------------------------	---------------------------------------------------------------------------------------------------------------------------------------------------------------------

Switching capacity

Commutator with gold plated contacts

Current type	Load type *2)	U min [V]	Max. permissible persistent current I _{max} [A] at U *1) (UL & CSA)					Electrical life-time
			M12x1 30 V	DIN EN 175301-803, form A 30 V	48 V	125 V	250 V	
a.c.	Ohmic, inductive	6	0,1	0,1	0,1	0,1	0,1	≥ 2 x 10 ⁵ Switching cycles
d.c.	Ohmic, inductive	6	0,1	0,1	—	—	—	

Reference number: 20/min, Reference temperature: +20°C.

I_{min} = 1 mA at 24 V d.c. or 5 mA at 6 V d.c.

*1) Higher currents (5 A max) will cause a reduction of the durability of the micro-switch contacts. Furthermore additional measures has to be taken to fulfil the EMV regulation 2014/30/EU by the manufacturer

*2) Spark quenching/overload protection will be necessary using inductive loads.

Recommended circuit

Spark quenching and EMV intrinsically safe

1. Quick diode (D) with $t_v \leq 200$ ns, parallel to inductive load.
2. RC link in parallel to load in parallel to switching contact.

Dimensioning principles:

R_L in $\Omega \approx 0,2 \times R_{Load}$ in Ω

C in $[\mu F] \approx I_{Load}$ in [A]

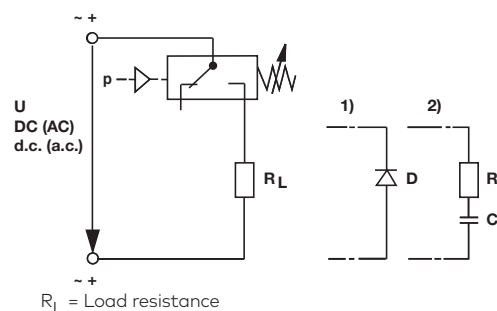

Drawings

 Dimensions in mm
 Projection/First angle

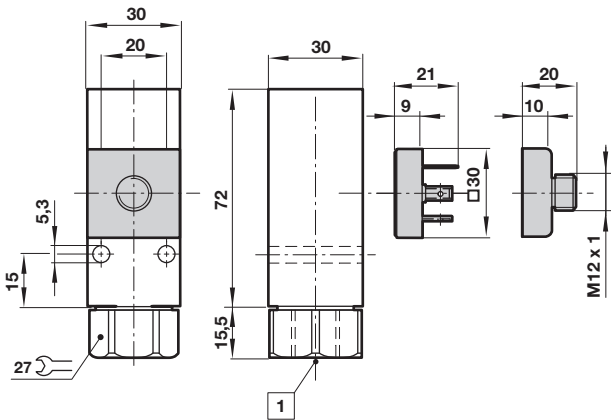
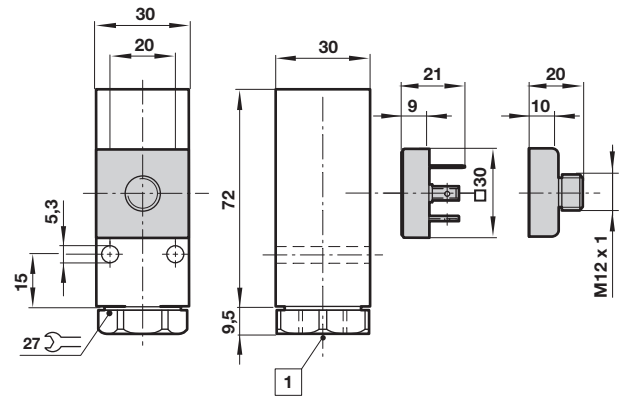
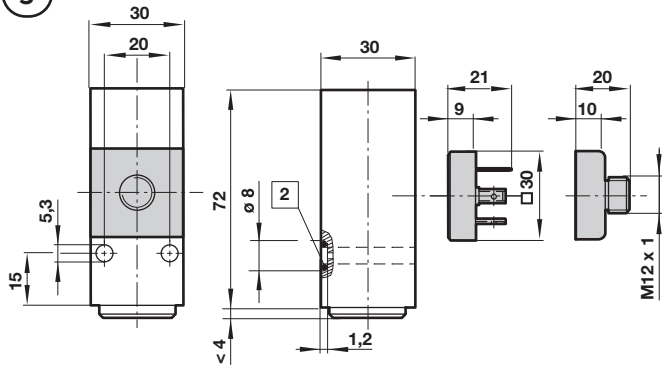
1

2

3

- 1 Fluid port
- 2 O-ring 5 x 1,5

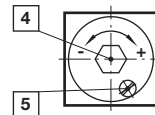
Adjustable switch point

After releasing the locking screw
 Clockwise rotation = increasing switch point
 Counter clockwise rotation = decreasing the switch point



- 4 Switch point screw
- 5 Locking screw

Pressure port reducing nipple

Model: 0574767 (brass)
 0550083 (stainless steel)

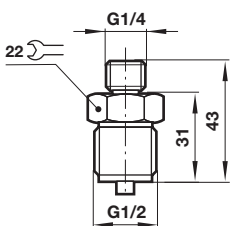
Surge damper

Model: 0574773 (brass)
 0553258 (stainless steel)

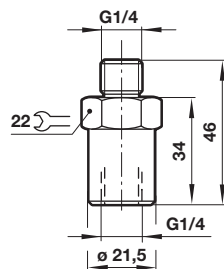
Cover

Model: 0554737 (plastic)

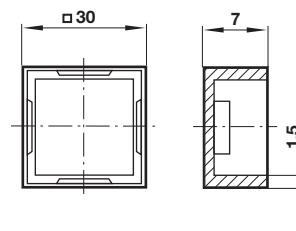
Warning

These products are intended for use in industrial compressed air systems only. Do not use these products where pressures and temperatures can exceed those listed under »**Technical features/ data**«.

Before using these products with fluids other than those specified, for non-industrial applications, life-support systems or other applications not within published specifications, consult Norgren.

Through misuse, age, or malfunction, components used in fluid power systems can fail in various modes.

The system designer is warned to consider the failure modes of all component parts used in fluid power systems and to provide adequate safeguards to prevent personal injury or damage to equipment in the event of such failure.

System designers must provide a warning to end users in the system instructional manual if protection against a failure mode cannot be adequately provided.

System designers and end users are cautioned to review specific warnings found in instruction sheets packed and shipped with these products.

X-ON Electronics

Largest Supplier of Electrical and Electronic Components

Click to view similar products for [Industrial Pressure Sensors](#) category:

Click to view products by [Norgren](#) manufacturer:

Other Similar products are found below :

[76311-05](#) [76577-00000070-01](#) [77343-24.0H2-01](#) [77343-25.0H2-01](#) [78303-B00000400-01](#) [78303-B00000400-05](#) [78316-B00000030-01](#)
[78353-B00000020-05](#) [78665-00000014-05](#) [78677-B00000070-05](#) [79279-00000060-01](#) [79296-B00000350-01](#) [79322-00250035-01](#) [79614-](#)
[30.0H2-14](#) [79700-00002750-01](#) [80569-00700100-01](#) [81739-B00000900-01](#) [MLH025BSCDJ1303](#) [MLH750PSCDJ1245](#) [82903-B00000020-01](#)
[83250-02500600-05](#) [83271-00000040-04](#) [83278-B00000200-21](#) [83282-00000100-05](#) [83286-00000150-01](#) [83298-00000120-01](#) [83299-](#)
[00000150-05](#) [83305-00001350-01](#) [83350-04.0HG-05](#) [83357-00000030-21](#) [83362-B00000040-04](#) [83507-00000150-01](#) [83807-18](#) [9223108](#)
[9243103](#) [9251405](#) [9303101](#) [9305823](#) [9306477](#) [9306478](#) [9306482](#) [9306496](#) [9309105](#) [PX2AN2XX100PSAAX](#) [1231-L902-08A](#)
[13C0500PS0LSZ76405](#) [13C1000PS4L/S76105](#) [13C1000PA4K/S75885](#) [1807706](#) [HPR04000BGDSPAAA25](#)