

Product Overview

The NSI822x devices are high reliability dual-channel digital isolators. The NSI822x device is safety certified by UL1577 support several insulation withstand voltages (3.75kVrms, 5kVrms), while providing high electromagnetic immunity and low emissions at low power consumption. The data rate of the NSI822x is up to 150Mbps, and the common-mode transient immunity (CMTI) is up to 250kV/us. The NSI822x device provides digital channel direction configuration and the default output level configuration when the input power is lost. Wide supply voltage of the NSI822x device support to connect with most digital interface directly, easy to do the level shift. High system level EMC performance enhance reliability and stability of use. AEC-Q100 (Grade 1) option is provided for all devices.

Key Features

- Up to 5000V_{rms} Insulation voltage
- Data rate: DC to 150Mbps
- Power supply voltage: 2.5V to 5.5V
- All devices are AEC-Q100 qualified
- High CMTI: 250kV/us
- Chip level ESD: HBM: ±8kV
- Robust EMC Reinforced Dual-Channel Digital Isolators for SOW8 wide body and SOW16 wide body
- Default output high level or low level option
- Isolation surge voltage: >10kV
- Low power consumption: 1.5mA/ch (1 Mbps)
- Low propagation delay: <15ns
- Operation temperature: -40°C~125°C
- RoHS-compliant packages:
 - SOP8 narrow body
 - SOW8 wide body
 - SOW16 wide body

Safety Regulatory Approvals

- UL recognition: up to 5000V_{rms} for 1 minute per UL1577
- CQC certification per GB4943.1-2011
- CSA component notice 5A
- DIN VDE V 0884-11:2017-01

Applications

- Industrial automation system
- Isolated SPI, RS232, RS485
- General-purpose multichannel isolation
- Motor control

Device Information

Part Number	Package	Body Size
NSI822xNx-DSPR	SOP8	4.90mm × 3.90mm
NSI822xWx-DSWVR	SOW8	5.85mm × 7.50mm
NSI822xWx-DSWR	SOW16	10.30mm × 7.50mm

Functional Block Diagrams

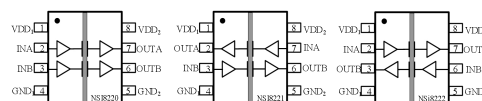

Figure 1. NSI822xN Block Diagram

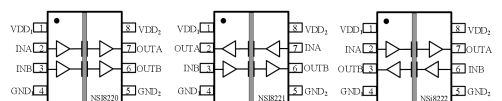

Figure 2. NSI822xW SOW8 Block Diagram

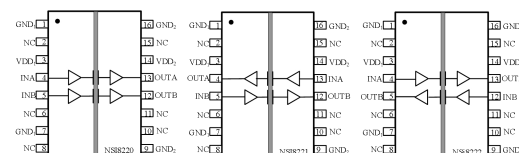

Figure 3. NSI822xW SOW16 Block Diagram

INDEX

1. PIN CONFIGURATION AND FUNCTIONS.....	3
2. ABSOLUTE MAXIMUM RATINGS.....	6
3. RECOMMENDED OPERATING CONDITIONS.....	7
4. THERMAL CHARACTERISTICS.....	7
5. SPECIFICATIONS.....	8
5.1. ELECTRICAL CHARACTERISTICS.....	8
5.2. SUPPLY CURRENT CHARACTERISTICS – 5V SUPPLY.....	8
5.3. SUPPLY CURRENT CHARACTERISTICS –3.3V SUPPLY.....	9
5.4. SUPPLY CURRENT CHARACTERISTICS–2.5V SUPPLY.....	10
5.5. SWITCHING CHARACTERISTICS - 5V SUPPLY.....	11
5.6. SWITCHING CHARACTERISTICS - 3.3V SUPPLY.....	12
5.7. SWITCHING CHARACTERISTICS - 2.5V SUPPLY.....	12
5.8. TYPICAL PERFORMANCE CHARACTERISTICS.....	13
5.9. PARAMETER MEASUREMENT INFORMATION.....	14
6. HIGH VOLTAGE FEATURE DESCRIPTION.....	15
6.1. INSULATION AND SAFETY RELATED SPECIFICATIONS.....	15
6.2. DIN VDE V 0884-11 (VDE V 0884-11) :2017-01 INSULATION CHARACTERISTICS.....	16
6.3. REGULATORY INFORMATION.....	19
7. FUNCTION DESCRIPTION.....	20
7.1. OVERVIEW.....	20
7.2. OOK MODULATION.....	21
8. APPLICATION NOTE.....	22
8.1. TYPICAL APPLICATION CIRCUIT.....	22
8.2. PCB LAYOUT.....	22
8.3. HIGH SPEED PERFORMANCE.....	23
8.4. TYPICAL SUPPLY CURRENT EQUATIONS.....	23
9. PACKAGE INFORMATION.....	24
10. ORDER INFORMATION.....	26
11. DOCUMENTATION SUPPORT.....	28
12. TAPE AND REEL INFORMATION.....	29
13. REVISION HISTORY.....	31

1. Pin Configuration and Functions

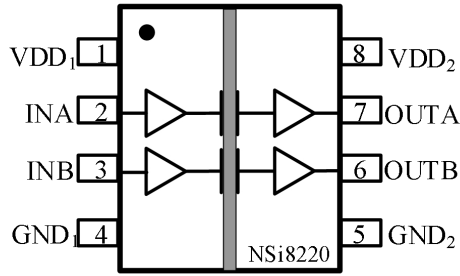

Figure 1.1 NSi8220N Package

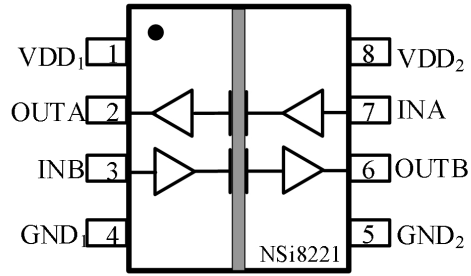

Figure 1.2 NSi8221N Package

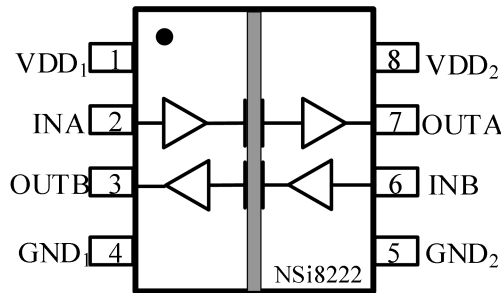

Figure 1.3 NSi8222N Package

Table 1.1 NSi8220N/ NSi8221N/ NSi8222N Pin Configuration and Description

<i>NSi8220N</i> <i>PIN NO.</i>	<i>NSi8221N</i> <i>PIN NO.</i>	<i>NSi8222N</i> <i>PIN NO.</i>	<i>SYMBOL</i>	<i>FUNCTION</i>
1	1	1	VDD1	Power Supply for Isolator Side 1
2	7	2	INA	Logic Input A
3	3	6	INB	Logic Input B
4	4	4	GND1	Ground 1, the ground reference for Isolator Side 1
5	5	5	GND2	Ground 2, the ground reference for Isolator Side 2
6	6	3	OUTB	Logic Output B
7	2	7	OUTA	Logic Output A
8	8	8	VDD2	Power Supply for Isolator Side 2

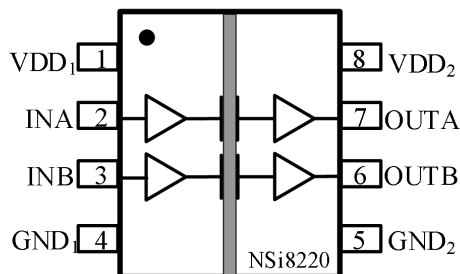

Figure 1.4 NSi8220Wx SOW8 Package

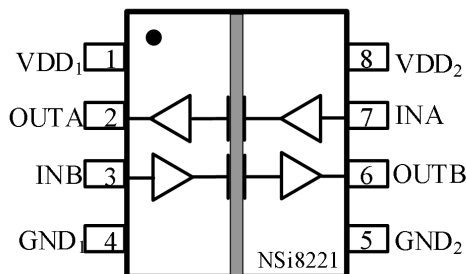

Figure 1.5 NSi8221Wx SOW8 Package

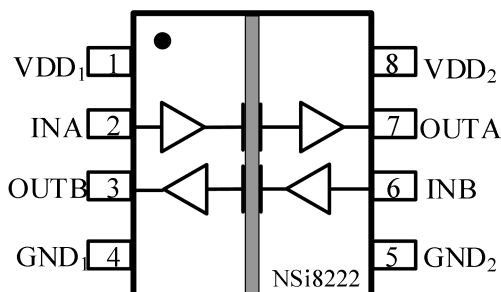

Figure 1.6 NSi8222Wx SOW8 Package

Table 1.2 NSi8220Wx/ NSi8221Wx/ NSi8222Wx SOW Pin Configuration and Description

<i>NSi8220W</i> PIN NO.	<i>NSi8221W</i> PIN NO.	<i>NSi8222W</i> PIN NO.	<i>SYMBOL</i>	<i>FUNCTION</i>
1	1	1	VDD1	Power Supply for Isolator Side 1
2	7	2	INA	Logic Input A
3	3	6	INB	Logic Input B
4	4	4	GND1	Ground 1, the ground reference for Isolator Side 1
5	5	5	GND2	Ground 2, the ground reference for Isolator Side 2
6	6	3	OUTB	Logic Output B
7	2	7	OUTA	Logic Output A
8	8	8	VDD2	Power Supply for Isolator Side 2

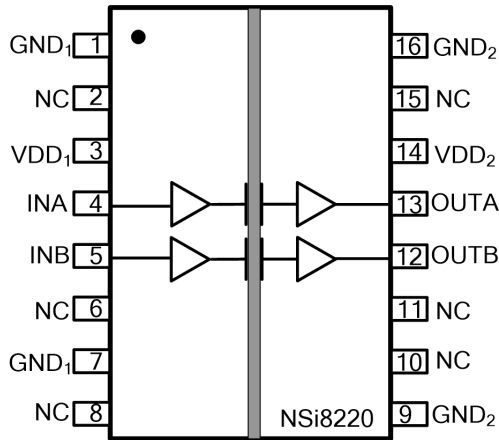

Figure 1.7 NSi8220W Package

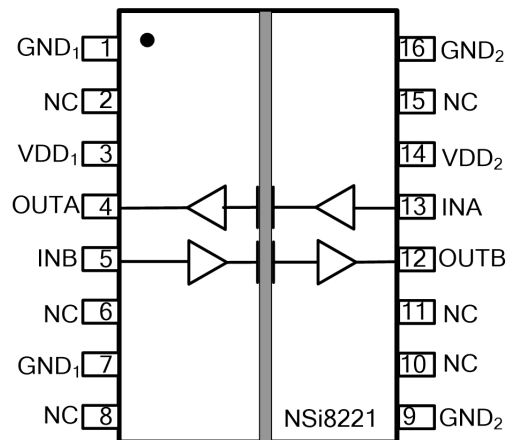

Figure 1.8 NSi8221W Package

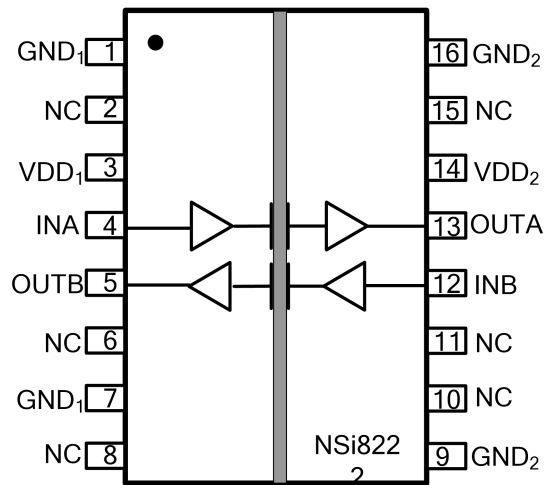

Figure 1.9 NSi8222W Package

Table 1.2 NSi8220W/ NSi8221W/ NSi8222W Pin Configuration and Description

NSi8220W PIN NO.	NSi8221W PIN NO.	NSi8222W PIN NO.	SYMBOL	FUNCTION
1	1	1	GND1	Ground 1, the ground reference for Isolator Side 1
2	2	2	NC	No Connection.
3	3	3	VDD1	Power Supply for Isolator Side 1
4	13	4	INA	Logic Input A
5	5	12	INB	Logic Input B

NSi8220W PIN NO.	NSi8221W PIN NO.	NSi8222W PIN NO.	SYMBOL	FUNCTION
6	6	6	NC	No Connection.
7	7	7	GND1	Ground 1, the ground reference for Isolator Side 1
8	8	8	NC	No Connection.
9	9	9	GND2	Ground 2, the ground reference for Isolator Side 2
10	10	10	NC	No Connection.
11	11	11	NC	No Connection.
12	12	5	OUTB	Logic Output A
13	4	13	OUTA	Logic Output B
14	14	14	VDD2	Power Supply for Isolator Side 2
15	15	15	NC	No Connection.
16	16	16	GND2	Ground 2, the ground reference for Isolator Side 2

2. Absolute Maximum Ratings

Parameters	Symbol	Min	Typ	Max	Unit	Comments
Power Supply Voltage	VDD1, VDD2	-0.5		6.5	V	
Maximum Input Voltage	VINA, VINB	-0.4		VDD+0.4 ¹	V	The maximum voltage must not exceed 6.5V
Maximum Output Voltage	V _{OUTA} , V _{OUTB}	-0.4		VDD+0.4 ¹	V	The maximum voltage must not exceed 6.5V
Maximum Input/Output Pulse Voltage	VINA, VINB, V _{OUTA} , V _{OUTB}	-0.8		VDD+0.8	V	Pulse width should be less than 100ns, and the duty cycle should be less than 10%
Output current	I _o	-15		15	mA	
Operating Temperature	T _{opr}	-40		125	°C	
Junction temperature	T _j	-40		150	°C	
Storage Temperature	T _{stg}	-40		150	°C	
Electrostatic discharge	HBM			±8000	V	

	CDM			±2000	V	
--	-----	--	--	-------	---	--

3. Recommended Operating Conditions

<i>Parameters</i>	<i>Symbol</i>	<i>min</i>	<i>typ</i>	<i>max</i>	<i>unit</i>
Power Supply Voltage	VDD1, VDD2	2.5		5.5	V
Operating Temperature	Topr	-40		125	°C
High Level Input Voltage	VIH	2			V
Low Level Input Voltage	VIL			0.8	V
Data rate	DR			150	Mbps

4. Thermal Characteristics

<i>Parameters</i>	<i>Symbol</i>	<i>SOW16</i>	<i>SOW8</i>	<i>SOP8</i>	<i>Unit</i>
IC Junction-to-Air Thermal Resistance	θ_{JA}	86.5	84.3	137.7	°C/W
Junction-to-case (top) thermal resistance	$\theta_{JC (top)}$	49.6	36.3	54.9	°C/W
Junction-to-board thermal resistance	θ_{JB}	49.7	47.0	71.7	°C/W

5. SPECIFICATIONS

5.1. Electrical Characteristics

(VDD1=2.5V~5.5V, VDD2=2.5V~5.5V, Ta=-40°C to 125°C. Unless otherwise noted, Typical values are at VDD1 = 5V, VDD2 = 5V, Ta = 25°C)

Parameters	Symbol	Min	Typ	Max	Unit	Comments
Power on Reset	VDD _{POR}		2.2		V	POR threshold as during power-up
	VDD _{HYS}		0.1		V	POR threshold Hysteresis
Input Threshold	V _{IT}		1.6		V	Input Threshold at rising edge
	V _{IT_HYS}		0.4		V	Input Threshold Hysteresis
High Level Input Voltage	V _{IH}	2			V	
Low Level Input Voltage	V _{IL}			0.8	V	
High Level Output Voltage	V _{OH}	VDD-0.4			V	I _{OH} ≤ 4mA
Low Level Output Voltage	V _{OL}			0.4	V	I _{OL} ≤ 4mA
Output Impedance	R _{out}		50		ohm	
Input Pull high or low Current	I _{pull}		8	15	uA	
Start Up Time after POR	tr _{bs}		10		usec	
Common Mode Transient Immunity	CMTI	±200	±250		kV/us	See Figure 5.8

5.2. Supply Current Characteristics – 5V Supply

(VDD1=5V± 10%, VDD2=5V± 10%, Ta=-40°C to 125°C. Unless otherwise noted, Typical values are at VDD1 = 5V, VDD2 = 5V, Ta = 25°C)

Parameters	Symbol	Min	Typ	Max	Unit	Comments
Supply current	NSi8220					
	I _{DD1} (Q0)		0.59	0.89	mA	All Input 0V for NSi8220x0 Or All Input at supply for NSi8220x1
	I _{DD2} (Q0)		1.29	1.94	mA	
	I _{DD1} (Q1)		2.80	4.20	mA	All Input at supply for NSi8220x0 Or All Input 0V for NSi8220x1
	I _{DD2} (Q1)		1.32	1.98	mA	
	I _{DD1} (1M)		1.70	2.55	mA	All Input with 1Mbps, C _L =15pF
I _{DD2} (1M)		1.39	2.09	mA		

Parameters	Symbol	Min	Typ	Max	Unit	Comments	
	I _{DD1} (10M)		1.78	2.67	mA	All Input with 10Mbps, C _L =15pF	
	I _{DD2} (10M)		2.13	3.20	mA		
	I _{DD1} (100M)		2.49	3.74	mA	All Input with 100Mbps, C _L =15pF	
	I _{DD2} (100M)		9.22	13.83	mA		
	NSi8221/ NSi8222						
	I _{DD1} (Q0)		0.94	1.41	mA	All Input 0V for NSi822xx0 Or All Input at supply for NSi822xx1	
	I _{DD2} (Q0)		0.94	1.41	mA		
	I _{DD1} (Q1)		2.06	3.09	mA	All Input at supply for NSi822xx0 Or All Input 0V for NSi822xx1	
	I _{DD2} (Q1)		2.06	3.09	mA		
	I _{DD1} (1M)		1.55	2.32	mA	All Input with 1Mbps, C _L =15pF	
	I _{DD2} (1M)		1.55	2.32	mA		
	I _{DD1} (10M)		1.96	2.93	mA	All Input with 10Mbps, C _L =15pF	
	I _{DD2} (10M)		1.96	2.93	mA		
	I _{DD1} (100M)		5.86	8.78	mA	All Input with 100Mbps, C _L = 15pF	
I _{DD2} (100M)		5.86	8.78	mA			

5.3. Supply Current Characteristics –3.3V Supply

(VDD1=3.3V± 10%, VDD2=3.3V± 10%, Ta=-40°C to 125°C. Unless otherwise noted, Typical values are at VDD1 = 3.3V, VDD2 = 3.3V, Ta = 25°C)

Parameters	Symbol	Min	Typ	Max	Unit	Comments
Supply current	NSi8220					
	I _{DD1} (Q0)		0.56	0.83	mA	All Input 0V for NSi8220x0 Or All Input at supply for NSi8220x1
	I _{DD2} (Q0)		1.24	1.86	mA	
	I _{DD1} (Q1)		2.76	4.13	mA	All Input at supply for NSi8220x0 Or All Input 0V for NSi8220x1
	I _{DD2} (Q1)		1.27	1.91	mA	
	I _{DD1} (1M)		1.66	2.49	mA	All Input with 1Mbps, C _L = 15pF
	I _{DD2} (1M)		1.31	1.97	mA	
	I _{DD1} (10M)		1.71	2.57	mA	All Input with 10Mbps, C _L = 15pF
I _{DD2} (10M)		1.80	2.70	mA		

Parameters	Symbol	Min	Typ	Max	Unit	Comments	
	I _{DD1} (100M)		2.20	3.30	mA	All Input with 100Mbps, C _L = 15pF	
	I _{DD2} (100M)		6.50	9.75	mA		
	NSi8221/ NSi8222						
	I _{DD1} (Q0)		0.90	1.35	mA	All Input 0V for NSi822xx0 Or All Input at supply for NSi822xx1	
	I _{DD2} (Q0)		0.90	1.35	mA		
	I _{DD1} (Q1)		2.01	3.02	mA	All Input at supply for NSi822xx0 Or All Input 0V for NSi822xx1	
	I _{DD2} (Q1)		2.01	3.02	mA		
	I _{DD1} (1M)		1.49	2.23	mA	All Input with 1Mbps, C _L = 15pF	
	I _{DD2} (1M)		1.49	2.23	mA		
	I _{DD1} (10M)		1.76	2.63	mA	All Input with 10Mbps, C _L = 15pF	
	I _{DD2} (10M)		1.76	2.63	mA		
	I _{DD1} (100M)		4.35	6.53	mA	All Input with 100Mbps, C _L = 15pF	
	I _{DD2} (100M)		4.35	6.53	mA		

5.4. Supply Current Characteristics–2.5V Supply

(VDD1=2.5V± 10%, VDD2=2.5V± 10%, Ta=-40°C to 125°C. Unless otherwise noted, Typical values are at **VDD1 = 2.5V, VDD2 = 2.5V, Ta = 25°C**)

Parameters	Symbol	Min	Typ	Max	Unit	Comments
Supply current	NSi8220					
	I _{DD1} (Q0)		0.54	0.81	mA	All Input 0V for NSi8220x0 Or All Input at supply for NSi8220x1
	I _{DD2} (Q0)		1.22	1.83	mA	
	I _{DD1} (Q1)		2.73	4.10	mA	All Input at supply for NSi8220x0 Or All Input 0V for NSi8220x1
	I _{DD2} (Q1)		1.24	1.86	mA	
	I _{DD1} (1M)		1.64	2.46	mA	All Input with 1Mbps, C _L = 15pF
	I _{DD2} (1M)		1.27	1.91	mA	
	I _{DD1} (10M)		1.67	2.51	mA	All Input with 10Mbps, C _L = 15pF
	I _{DD2} (10M)		1.65	2.48	mA	
	I _{DD1} (100M)		1.98	2.97	mA	All Input with 100Mbps,

	I _{DD2} (100M)		5.22	7.83	mA	C _L = 15pF
NSi8221/ NSi8222						
	I _{DD1} (Q0)		0.88	1.32	mA	All Input 0V for NSi822xx0 Or All Input at supply for NSi822xx1
	I _{DD2} (Q0)		0.88	1.32	mA	
	I _{DD1} (Q1)		1.99	2.98	mA	All Input at supply for NSi822xx0 Or All Input 0V for NSi822xx1
	I _{DD2} (Q1)		1.99	2.98	mA	
	I _{DD1} (1M)		1.46	2.18	mA	All Input with 1Mbps, C _L = 15pF
	I _{DD2} (1M)		1.46	2.18	mA	
	I _{DD1} (10M)		1.66	2.49	mA	All Input with 10Mbps, C _L = 15pF
	I _{DD2} (10M)		1.66	2.49	mA	
	I _{DD1} (100M)		3.60	5.40	mA	All Input with 100Mbps, C _L = 15pF
	I _{DD2} (100M)		3.60	5.40	mA	

5.5. Switching Characteristics - 5V Supply

(VDD1=5V± 10%, VDD2=5V± 10%, Ta=-40°C to 125°C. Unless otherwise noted, Typical values are at VDD1 = 5V, VDD2 = 5V, Ta = 25°C)

Parameters	Symbol	Min	Typ	Max	Unit	Comments
Data Rate	DR	0		150	Mbps	
Minimum Pulse Width	PW			5.0	ns	
Propagation Delay	t _{PLH}	2.5	6.54	15	ns	See Figure 5.7 , C _L = 15pF
	t _{PHL}	2.5	8.30	15	ns	See Figure 5.7 , C _L = 15pF
Pulse Width Distortion t _{PHL} - t _{PLH}	PWD			5.0	ns	See Figure 5.7 , C _L = 15pF
Rising Time	t _r			5.0	ns	See Figure 5.7 , C _L = 15pF
Falling Time	t _f			5.0	ns	See Figure 5.7 , C _L = 15pF
Peak Eye Diagram Jitter	t _{JIT} (PK)		350		ps	
Channel-to-Channel Delay Skew	t _{SK} (c2c)			2.5	ns	
Part-to-Part Delay Skew	t _{SK} (p2p)			5.0	ns	

5.6. Switching Characteristics - 3.3V Supply

(VDD1=3.3V± 10%, VDD2=3.3V± 10%, Ta=-40°C to 125°C. Unless otherwise noted, Typical values are at VDD1 = 3.3V, VDD2 = 3.3V, Ta = 25°C)

Parameters	Symbol	Min	Typ	Max	Unit	Comments
Data Rate	DR	0		150	Mbps	
Minimum Pulse Width	PW			5.0	ns	
Propagation Delay	t _{PLH}	2.5	8.0	15	ns	See Figure 5.7 , C _L = 15pF
	t _{PHL}	2.5	8.7	15	ns	See Figure 5.7 , C _L = 15pF
Pulse Width Distortion t _{PHL} - t _{PLH}	PWD			5.0	ns	See Figure 5.7 , C _L = 15pF
Rising Time	t _r			5.0	ns	See Figure 5.7 , C _L = 15pF
Falling Time	t _f			5.0	ns	See Figure 5.7 , C _L = 15pF
Peak Eye Diagram Jitter	t _{JIT} (PK)		350		ps	
Channel-to-Channel Delay Skew	t _{SK} (c2c)			2.5	ns	
Part-to-Part Delay Skew	t _{SK} (p2p)			5.0	ns	

5.7. Switching Characteristics - 2.5V Supply

(VDD1=2.5V± 10%, VDD2=2.5V± 10%, Ta=-40°C to 125°C. Unless otherwise noted, Typical values are at VDD1 = 2.5V, VDD2 = 2.5V, Ta = 25°C)

Parameters	Symbol	Min	Typ	Max	Unit	Comments
Data Rate	DR	0		150	Mbps	
Minimum Pulse Width	PW			5.0	ns	
Propagation Delay	t _{PLH}	2.5	9.0	15	ns	See Figure 5.7 , C _L = 15pF
	t _{PHL}	2.5	9.3	15	ns	See Figure 5.7 , C _L = 15pF
Pulse Width Distortion t _{PHL} - t _{PLH}	PWD			5.0	ns	See Figure 5.7 , C _L = 15pF
Rising Time	t _r			5.0	ns	See Figure 5.7 , C _L = 15pF
Falling Time	t _f			5.0	ns	See Figure 5.7 , C _L = 15pF

Peak Eye Diagram Jitter	$t_{jrr}(PK)$		350		ps	
Channel-to-Channel Delay Skew	$t_{sk}(c2c)$			2.5	ns	
Part-to-Part Delay Skew	$t_{sk}(p2p)$			5.0	ns	

5.8. Typical Performance Characteristics

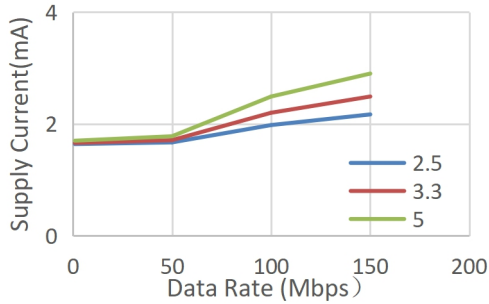

Figure 5.1 NSi8220 VDD1 Supply Current vs Data Rate

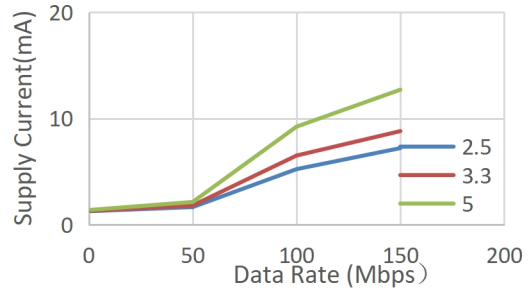

Figure 5.2 NSi8220 VDD2 Supply Current vs Data Rate

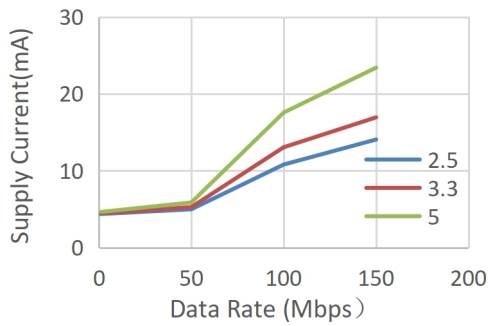

Figure 5.3 NSi8221/ NSi8222 VDD1 Supply Current vs Data Rate

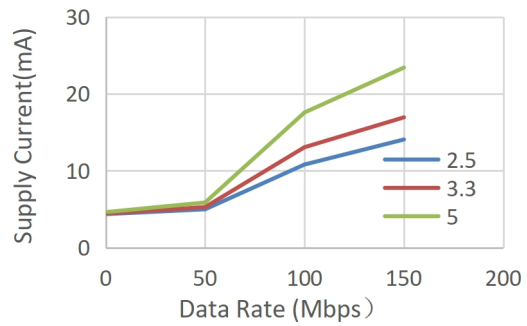

Figure 5.4 NSi8221/ NSi8222 VDD2 Supply Current vs Data Rate

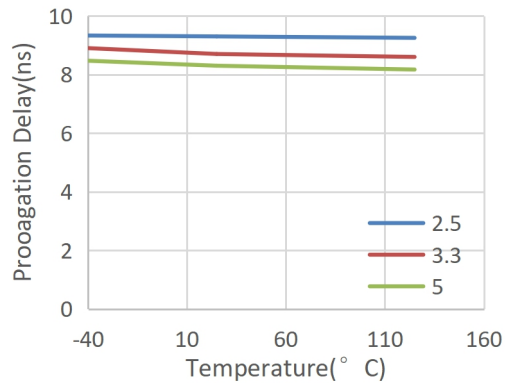
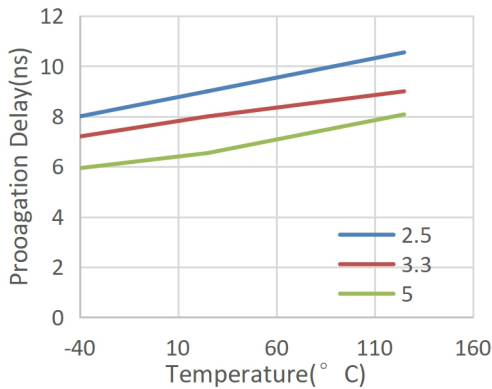

Figure 5.5 Rising Edge Propagation Delay Vs Temp

Figure 5.6 Falling Edge Propagation Delay Vs Temp

5.9. Parameter Measurement Information

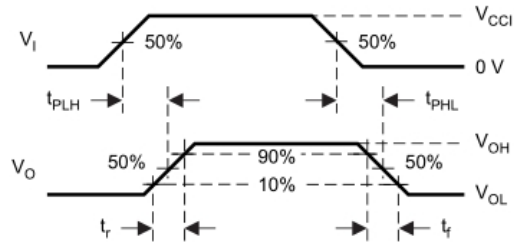
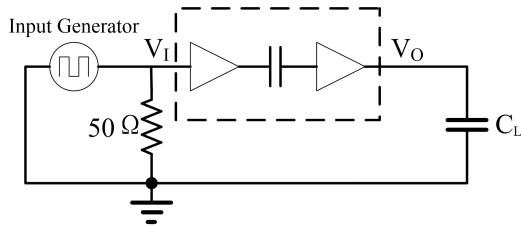

Figure 5.7 Switching Characteristics Test Circuit and Waveform

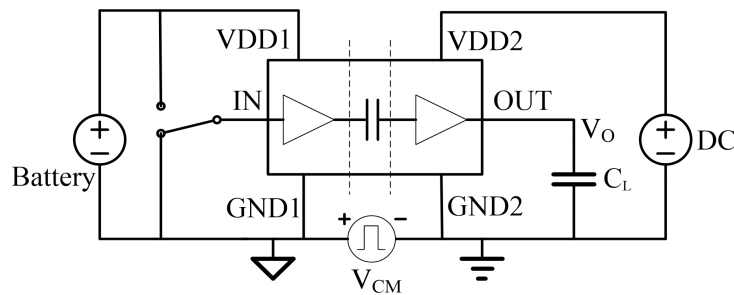

Figure 5.8 Common-Mode Transient Immunity Test Circuit

6. High Voltage Feature Description

6.1. Insulation and Safety Related Specifications

Parameters	Symbol	Value			Unit	Comments
		SOP8	SOW_8	SOW-16		
Minimum External Air Gap (Clearance)	L(I01)	4.0	8.0	8.0	mm	Shortest terminal-to-terminal distance through air
Minimum External Tracking (Creepage)	L(I02)	4.0	8.0	8.0	mm	Shortest terminal-to-terminal distance across the package surface
Minimum internal gap	DTI	20			um	Distance through insulation
Tracking Resistance(Comparative Tracking Index)	CTI	>400	>600	>600	V	DIN EN 60112 (VDE 0303-11); IEC 60112
Material Group		II	I	I		

6.2. DIN VDE V 0884-11 (VDE V 0884-11) :2017-01 Insulation Characteristics

Description	Test Condition	Symbol	Value	Value	Value	Unit
			SOP8	SOW8	SOIC-16	
Installation Classification per DIN VDE 0110						
For Rated Mains Voltage $\leq 150V_{rms}$			I to IV	I to IV	I to IV	
For Rated Mains Voltage $\leq 300V_{rms}$			I to III	I to IV	I to IV	
For Rated Mains Voltage $\leq 400V_{rms}$			I to III	I to IV	I to IV	
Climatic Classification			10/105/21	10/105/21	10/105/21	
Pollution Degree per DIN VDE 0110, Table 1			2	2	2	
Maximum repetitive isolation voltage		V_{IORM}	565	2121	2121	Vpeak
Maximum Working Isolation Voltage	AC voltage	V_{IOWM}	400	1500	1500	V_{RMS}
	DC voltage		565	2121	2121	V_{DC}
Input to Output Test Voltage, Method B1	$V_{IORM} \times 1.5 = V_{pd(m)}$, 100% production test, $t_{ini} = t_m = 1 \text{ sec}$, $q_{pd} < 5 \text{ pC}$	$V_{pd(m)}$	847	/	/	Vpeak
	$V_{IORM} \times 1.875 = V_{pd(m)}$, 100% production test, $t_{ini} = t_m = 1 \text{ sec}$, $q_{pd} < 5 \text{ pC}$		/	3977	3977	
Input to Output Test Voltage, Method A						
After Environmental Tests Subgroup 1	$V_{IORM} \times 1.2 = V_{pd(m)}$, $t_{ini} = 60 \text{ sec}$, $t_m = 10 \text{ sec}$, $q_{pd} < 5 \text{ pC}$	$V_{pd(m)}$	678	/	/	Vpeak
	$V_{IORM} \times 1.6 = V_{pd(m)}$, $t_{ini} = 60 \text{ sec}$, $t_m = 10 \text{ sec}$, $q_{pd} < 5 \text{ pC}$		/	3394	3394	
After Input and /or Safety Test Subgroup 2 and Subgroup 3	$V_{IORM} \times 1.2 = V_{pd(m)}$, $t_{ini} = 60 \text{ sec}$, $t_m = 10 \text{ sec}$, partial discharge $< 5 \text{ pC}$	$V_{pd(m)}$	678	2545	2545	Vpeak
Maximum transient isolation voltage	$t = 60 \text{ sec}$	VIOTM	5300	8000	8000	Vpeak
Maximum withstanding isolation voltage	$V_{TEST} = V_{ISO}$, $t = 60 \text{ s}$ (qualification); $V_{TEST} = 1.2 \times V_{ISO}$, $t = 1 \text{ s}$	VISO	3750	5000	5000	V_{RMS}

	(100%production)					
Maximum Surge Isolation Voltage	Test method per IEC60065,1.2/50us waveform, VTEST=VIOSM×1.3	VIOSM	5384			Vpeak
	Test method per IEC60065,1.2/50us waveform, VTEST=VIOSM×1.6			6250	6250	Vpeak
Isolation resistance	$V_{IO}=500V$ at $T_{amb}=T_s$	RIO	$>10^9$	$>10^9$	$>10^9$	Ω
	$V_{IO}=500V$ at $100^\circ C \leq T_{amb} \leq 125^\circ C$		$>10^{11}$	$>10^{11}$	$>10^{11}$	Ω
Isolation capacitance	f = 1MHz	CIO	0.6	0.6	0.6	pF
Input capacitance		CI	2	2	2	pF
Total Power Dissipation at 25°C		Ps	908	1483	1445	mW
Safety input, output, or supply current	$\theta_{JA} = 137.7^\circ C/W$, V I = 5.5 V, T J = 150 °C, T A = 25 °C	Is	165			mA
	$\theta_{JA} = 84.3^\circ C/W$, V I = 5.5 V, T J = 150 °C, T A = 25 °C			269.6		
	$\theta_{JA} = 86.5^\circ C/W$, V I = 5.5 V, T J = 150 °C, T A = 25 °C				262.7	mA
Case Temperature		Ts	150	150	150	°C

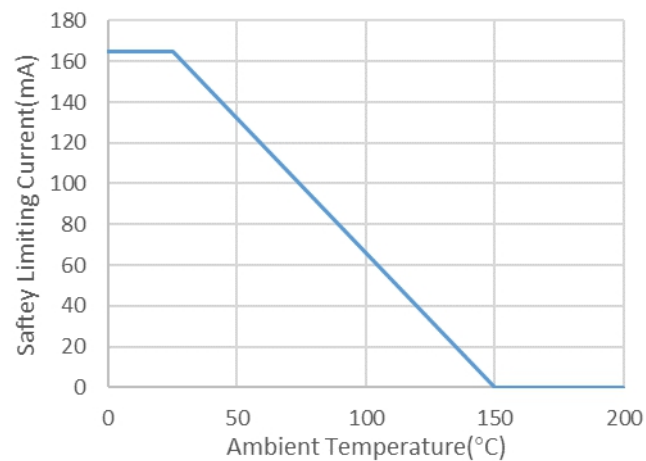

Figure 6.1 NSi822xN-DSPR Thermal Derating Curve, Dependence of Safety Limiting Values with Case Temperature per DIN VDE V 0884-11

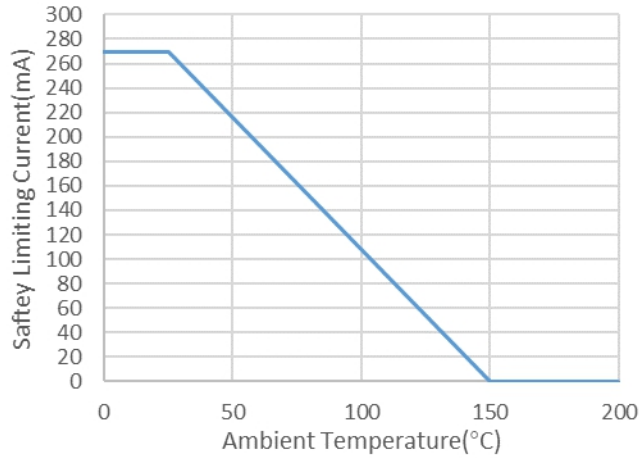

Figure 6.2 NSi822xW-DSWR Thermal Derating Curve, Dependence of Safety Limiting Values with Case Temperature per DIN VDE V 0884-11

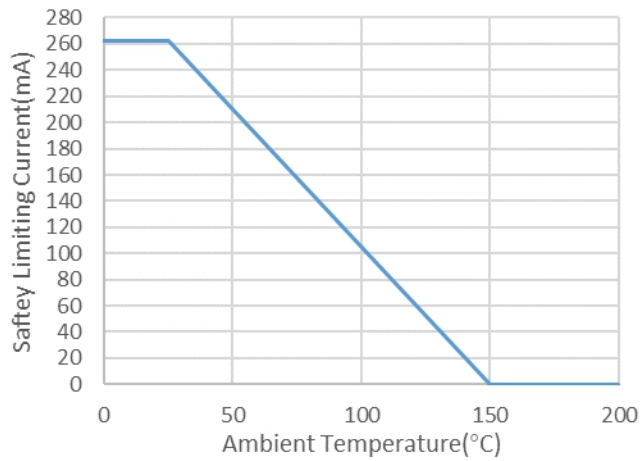

Figure 6.3 NSi822xW-DSWR Thermal Derating Curve, Dependence of Safety Limiting Values with Case Temperature per DIN VDE V 0884-11

6.3. Regulatory Information

The NSi8220N/NSi8221N/NSi8222N are approved by the organizations listed in table.

<i>CUL</i>		<i>VDE</i>	<i>CQC</i>
UL 1577 Component Recognition Program ¹	Approved under CSA Component Acceptance Notice 5A	DIN VDE V 0884-11:2017-01 ²	Certified by CQC11-471543-2012 GB4943.1-2011
Single Protection, 3750V _{rms} Isolation voltage	Single Protection, 3750V _{rms} Isolation voltage	Basic Insulation 565V _{peak} , V _{IOSM} =5384V _{peak}	Basic insulation at 400V _{rms} (565V _{peak})
File (E500602)	File (E500602)	File (pending)	File (CQC20001264940)

The NSi8220W-DSWVR/NSi8221W-DSWVR/NSi8222W-DSWVR are approved by the organizations listed in table.

<i>CUL</i>		<i>VDE</i>	<i>CQC</i>
UL 1577 Component Recognition Program ¹	Approved under CSA Component Acceptance Notice 5A	DIN VDE V 0884-11(VDE V 0884-11):2017-01 ²	Certified by CQC11-471543-2012 GB4943.1-2011
Single Protection, 5000V _{rms} Isolation voltage	Single Protection, 5000V _{rms} Isolation voltage	Reinforced Insulation 2121V _{peak} , V _{IOSM} =6250V _{peak}	Reinforced insulation at 1500V _{rms} (2121V _{peak})
File (pending)	File (pending)	File (5024579-4880-0002 / 276211)	File (CQC20001264938)

The NSi8220W-DSWR/NSi8221W-DSWR/NSi8222W-DSWR are approved by the organizations listed in table.

<i>CUL</i>		<i>VDE</i>	<i>CQC</i>
UL 1577 Component Recognition Program ¹	Approved under CSA Component Acceptance Notice 5A	DIN VDE V 0884-11(VDE V 0884-11):2017-01 ²	Certified by CQC11-471543-2012 GB4943.1-2011
Single Protection, 5000V _{rms} Isolation voltage	Single Protection, 5000V _{rms} Isolation voltage	Reinforced Insulation 2121V _{peak} , V _{IOSM} =6250V _{peak}	Reinforced insulation at 1500V _{rms} (2121V _{peak})
File (pending)	File (pending)	File (5024579-4880-0002 / 276211)	File (CQC20001264939)

7. Function Description

7.1. Overview

The NSi822x is a Dual-channel digital isolator based on a capacitive isolation barrier technique. The digital signal is modulated with RF carrier generated by the internal oscillator at the Transmitter side. Then it is transferred through the capacitive isolation barrier and demodulated at the Receiver side.

The NSi822x devices are high reliability dual-channel digital isolator with AEC-Q100 qualified. The NSi822x device is safety certified by UL1577 support several insulation withstand voltages (3.75kV_{rms}, 5kV_{rms}), while providing high electromagnetic immunity and low emissions at low power consumption. The data rate of the NSi822x is up to 150Mbps, and the common-mode transient immunity (CMTI) is up to 250kV/us. The NSi822x device provides digital channel direction configuration and the default output level configuration when the input power is lost. Wide supply voltage of the NSi822x device support to connect with most digital interface directly, easy to do the level shift. High system level EMC performance enhance reliability and stability of use.

The NSi822x has a default output status when VDDIN is unready and VDDOUT is ready as shown in Table 4.1, which helps for diagnosis when power is missing at the transmitter side. The output B follows the same status with the input A within 60us after powering up.

Table 7.1 Output status vs. power status

<i>Input</i>	<i>VDD1 status</i>	<i>VDD2 status</i>	<i>Output</i>	<i>Comment</i>
H ¹	Ready	Ready	H	Normal operation.
L ²	Ready	Ready	L	
X ³	Unready	Ready	L H	The output follows the same status with the input within 60us after input side VDD1 is powered on.
X	Ready	Unready	X	The output follows the same status with the input within 60us after output side VDD2 is powered on.
Note: H=Logic high; L=Logic low; X=Logic low or logic high VDD1 is input side power;VDD2 is out side power.				

7.2. OOK Modulation

NSi822x is based on a capacitive isolation barrier technique and the digital signal is modulated with RF carrier generated by the internal oscillator at the transmitter side, as shown in Figure 7.1, then it is transferred through the capacitive isolation barrier and demodulated at the receiver side. The modulation uses OOK modulation technique with key benefits of high noise immunity and low radiation EMI.

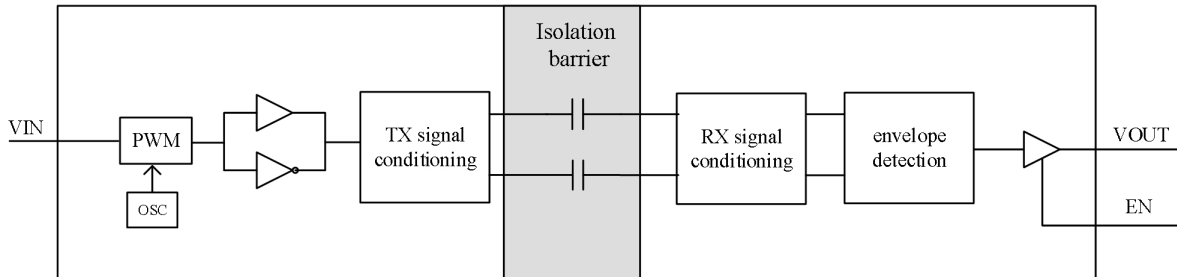

Figure 7.1 Single Channel Function Block Diagram

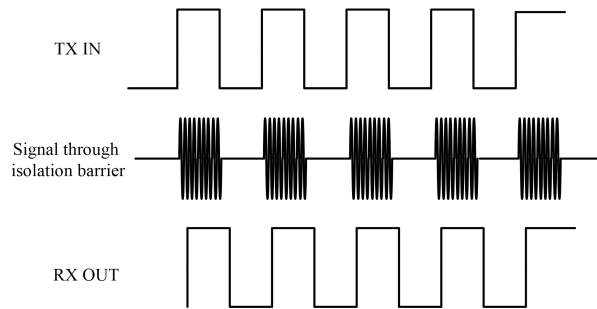

Figure 7.2 OOK Modulation

8. Application Note

8.1. Typical Application Circuit

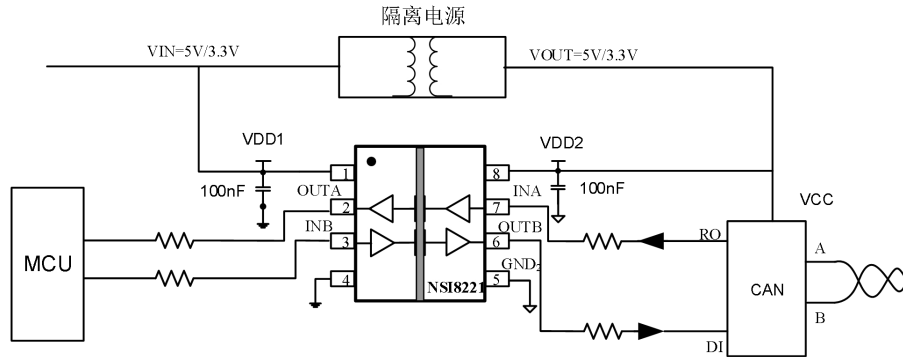

Figure 8.1 Typical SCH for ISO CAN Interface

8.2. PCB Layout

The NSi822x requires a 0.1 μF bypass capacitor between VDD1 and GND1, VDD2 and GND2. The capacitor should be placed as close as possible to the package. Figure 5.1 to Figure 5.4 show the recommended PCB layout, make sure the space under the chip should keep free from planes, traces, pads and via. To enhance the robustness of a design, the user may also include resistors (50–300 Ω) in series with the inputs and outputs if the system is excessively noisy. The series resistors also improve the system reliability such as latch-up immunity.

The typical output impedance of an isolator driver channel is approximately 50 Ω , $\pm 40\%$. When driving loads where transmission line effects will be a factor, output pins should be appropriately terminated with controlled impedance PCB traces.

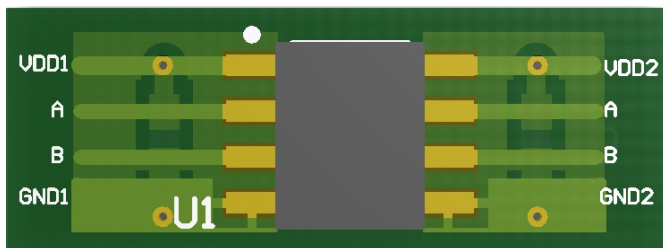

Figure8.1 Recommended PCB Layout — Top Layer



Figure8.2 Recommended PCB Layout — Bottom Layer

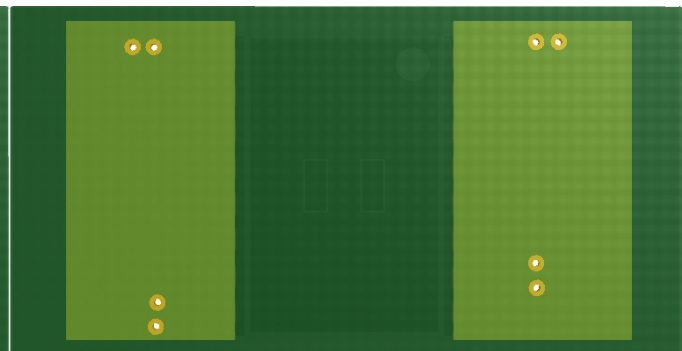
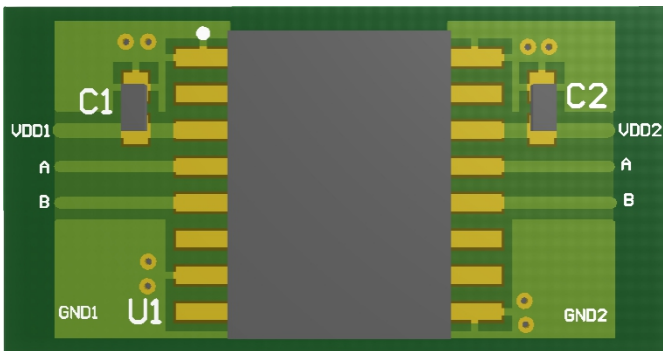

Figure8.3 Recommended PCB Layout — Top Layer

Figure8.4 Recommended PCB Layout — Bottom Layer

8.3. High Speed Performance

Figure 5.5 shows the eye diagram of NSi822x at 200Mbps data rate output. The result shows a typical measurement on the NSi822x with 350ps p-p jitter.

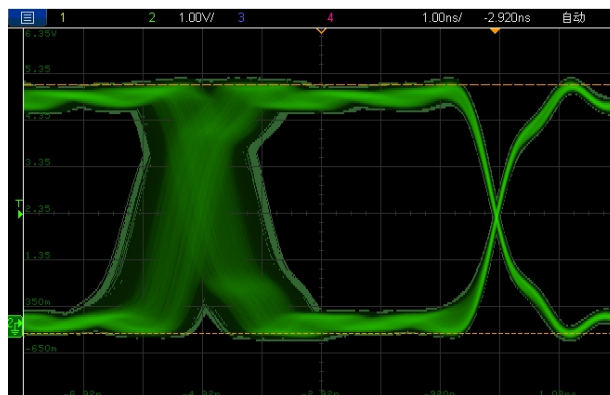

Figure8.5 NSi822x Eye Diagram

8.4. Typical Supply Current Equations

The typical supply current of NSi822x can be calculated using below equations. I_{DD1} and I_{DD2} are typical supply currents measured in mA, f is data rate measured in Mbps, C_L is the capacitive load measured in pF

NSi8220:

$$I_{DD1} = 0.19 * a1 + 1.45 * b1 + 0.82 * c1.$$

$$I_{DD2} = 1.36 + VDD1 * f * C_L * c1 * 10^{-9}$$

When $a1$ is the channel number of low input at side 1, $b1$ is the channel number of high input at side 1, $c1$ is the channel number of switch signal input at side 1.

NSi8221/ NSi8222:

$$I_{DD1} = 0.87 + 1.26 * b1 + 0.63 * c1 + VDD1 * f * C_L * c2 * 10^{-9}$$

$$I_{DD2} = 0.87 + 1.26 * b2 + 0.63 * c2 + VDD1 * f * C_L * c1 * 10^{-9}$$

When $b1$ is the channel number of high input at side 1, $c1$ is the channel number of switch signal input at side 1, $b2$ is the channel number of high input at side 2, $c2$ is the channel number of switch signal input at side 2.

9. Package Information

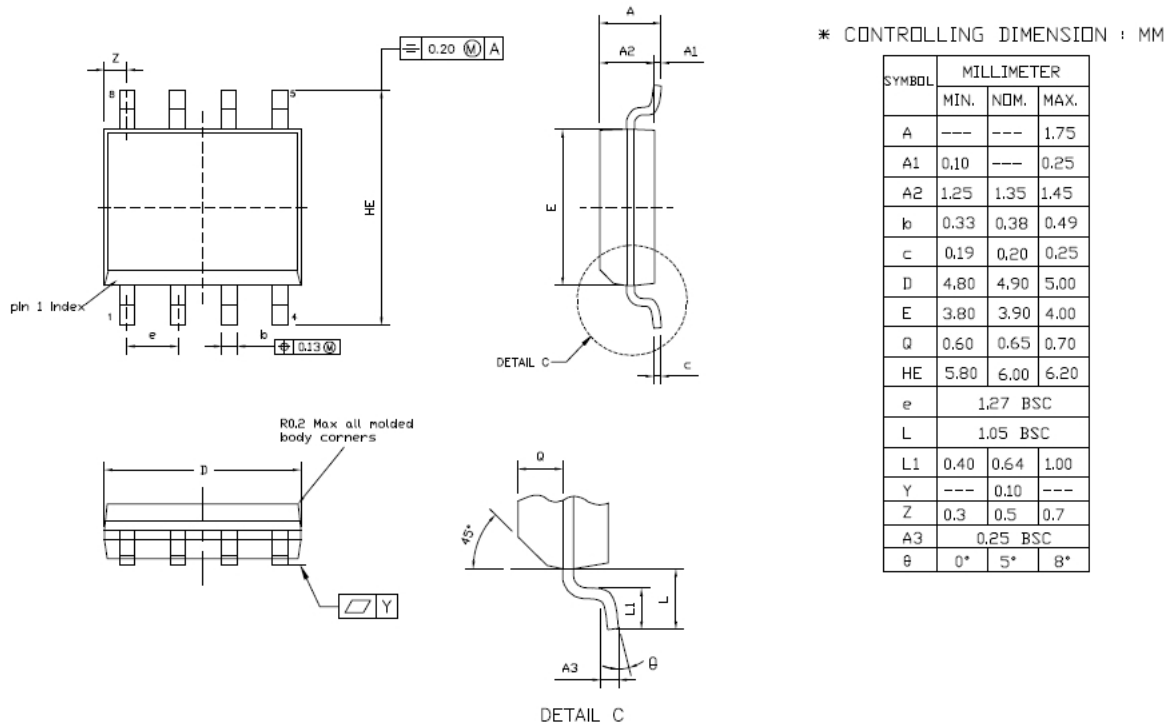

Figure 9.1 SOP8 Package Shape and Dimension in millimeters

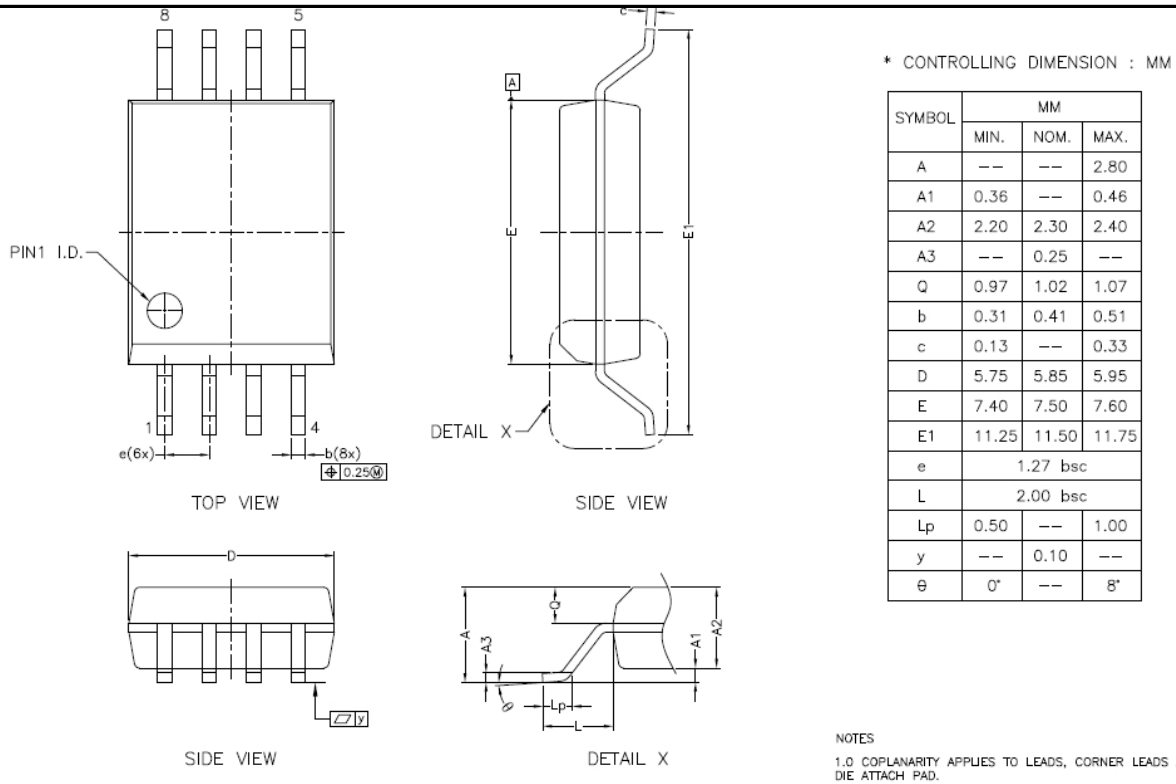

Figure 9.2 SOW8 Package Shape and Dimension in millimeters

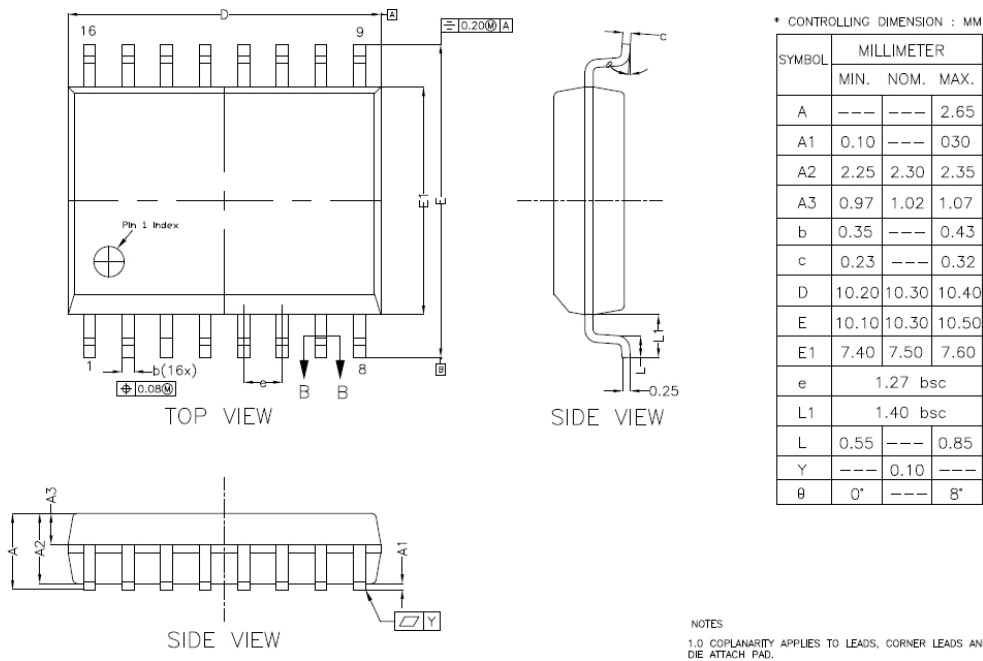

Figure 9.2 SOW16 Package Shape and Dimension in millimeters

10. Order Information

Part Number	Isolation Rating (kV)	Number of side 1 inputs	Number of side 2 inputs	Max Data Rate (Mbps)	Default Output State	Temperature	MSL	Package Type	Package Drawing	SPQ
NSi8220N0-DSPR	3.75	2	0	150	Low	-40 to 125 °C	1	SOP8 (150mil)	SOP8	2500
NSi8220N1-DSPR	3.75	2	0	150	High	-40 to 125 °C	1	SOP8 (150mil)	SOP8	2500
NSi8221N0-DSPR	3.75	1	1	150	Low	-40 to 125 °C	1	SOP8 (150mil)	SOP8	2500
NSi8221N1-DSPR	3.75	1	1	150	High	-40 to 125 °C	1	SOP8 (150mil)	SOP8	2500
NSi8222N0-DSPR	3.75	1	1	150	Low	-40 to 125 °C	1	SOP8 (150mil)	SOP8	2500
NSi8222N1-DSPR	3.75	1	1	150	High	-40 to 125 °C	1	SOP8 (150mil)	SOP8	2500
NSi8220W0-DSWR	5	2	0	150	Low	-40 to 125 °C	2	SOW16 (300mil)	SOW16	1000
NSi8220W1-DSWR	5	2	0	150	High	-40 to 125 °C	2	SOW16 (300mil)	SOW16	1000
NSi8221W0-DSWR	5	1	1	150	Low	-40 to 125 °C	2	SOW16 (300mil)	SOW16	1000
NSi8221W1-DSWR	5	1	1	150	High	-40 to 125 °C	2	SOW16 (300mil)	SOW16	1000
NSi8222W0-DSWR	5	1	1	150	Low	-40 to 125 °C	2	SOW16 (300mil)	SOW16	1000
NSi8222W1-DSWR	5	1	1	150	High	-40 to 125 °C	2	SOW16 (300mil)	SOW16	1000
NSi8220W0-DSWVR	5	2	0	150	Low	-40 to 125 °C	3	SOW8 (300mil)	SOW8	1000
NSi8220W1-DSWVR	5	2	0	150	High	-40 to 125 °C	3	SOW8 (300mil)	SOW8	1000
NSi8221W0-DSWVR	5	1	1	150	Low	-40 to 125 °C	3	SOW8 (300mil)	SOW8	1000
NSi8221W1-DSWVR	5	1	1	150	High	-40 to 125 °C	3	SOW8 (300mil)	SOW8	1000
NSi8222W0-DSWVR	5	1	1	150	Low	-40 to 125 °C	3	SOW8 (300mil)	SOW8	1000
NSi8222W1-DSWVR	5	1	1	150	High	-40 to 125 °C	3	SOW8 (300mil)	SOW8	1000
NSi8220W0-Q1SWR	5	2	0	150	Low	-40 to 125 °C	2	SOW16 (300mil)	SOW16	1000
NSi8220W1-Q1SWR	5	2	0	150	High	-40 to 125 °C	2	SOW16 (300mil)	SOW16	1000
NSi8221W0-	5	1	1	150	Low	-40 to 125 °C	2	SOW16	SOW16	1000

Part Number	Isolation Rating (kV)	Number of side 1 inputs	Number of side 2 inputs	Max Data Rate (Mbps)	Default Output State	Temperature	MSL	Package Type	Package Drawing	SPQ
Q1SWR								(300mil)		
NSi8221W1-Q1SWR	5	1	1	150	High	-40 to 125°C	2	SOW16 (300mil)	SOW16	1000
NSi8222W0-Q1SWR	5	1	1	150	Low	-40 to 125°C	2	SOW16 (300mil)	SOW16	1000
NSi8222W1-Q1SWR	5	1	1	150	High	-40 to 125°C	2	SOW16 (300mil)	SOW16	1000
NSi8220W0-Q1SWVR	5	2	0	150	Low	-40 to 125°C	3	SOW8 (300mil)	SOW8	1000
NSi8220W1-Q1SWVR	5	2	0	150	High	-40 to 125°C	3	SOW8 (300mil)	SOW8	1000
NSi8221W0-Q1SWVR	5	1	1	150	Low	-40 to 125°C	3	SOW8 (300mil)	SOW8	1000
NSi8221W1-Q1SWVR	5	1	1	150	High	-40 to 125°C	3	SOW8 (300mil)	SOW8	1000
NSi8222W0-Q1SWVR	5	1	1	150	Low	-40 to 125°C	3	SOW8 (300mil)	SOW8	1000
NSi8222W1-Q1SWVR	5	1	1	150	High	-40 to 125°C	3	SOW8 (300mil)	SOW8	1000

NOTE: All packages are RoHS-compliant with peak reflow temperatures of 260 °C according to the JEDEC industry standard classifications and peak solder temperatures.
All devices are AEC-Q100 qualified.

Part Number Rule:

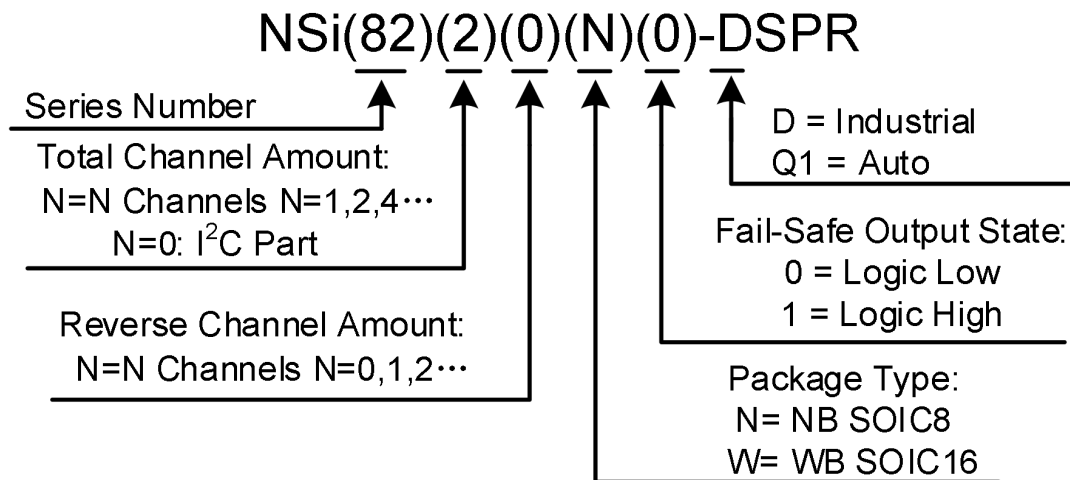

11. Documentation Support

<i>Part Number</i>	<i>Product Folder</i>	<i>Datasheet</i>	<i>Technical Documents</i>	<i>Isolator selection guide</i>
NSI822x	Click here	Click here	Click here	Click here

12. TAPE AND REEL INFORMATION

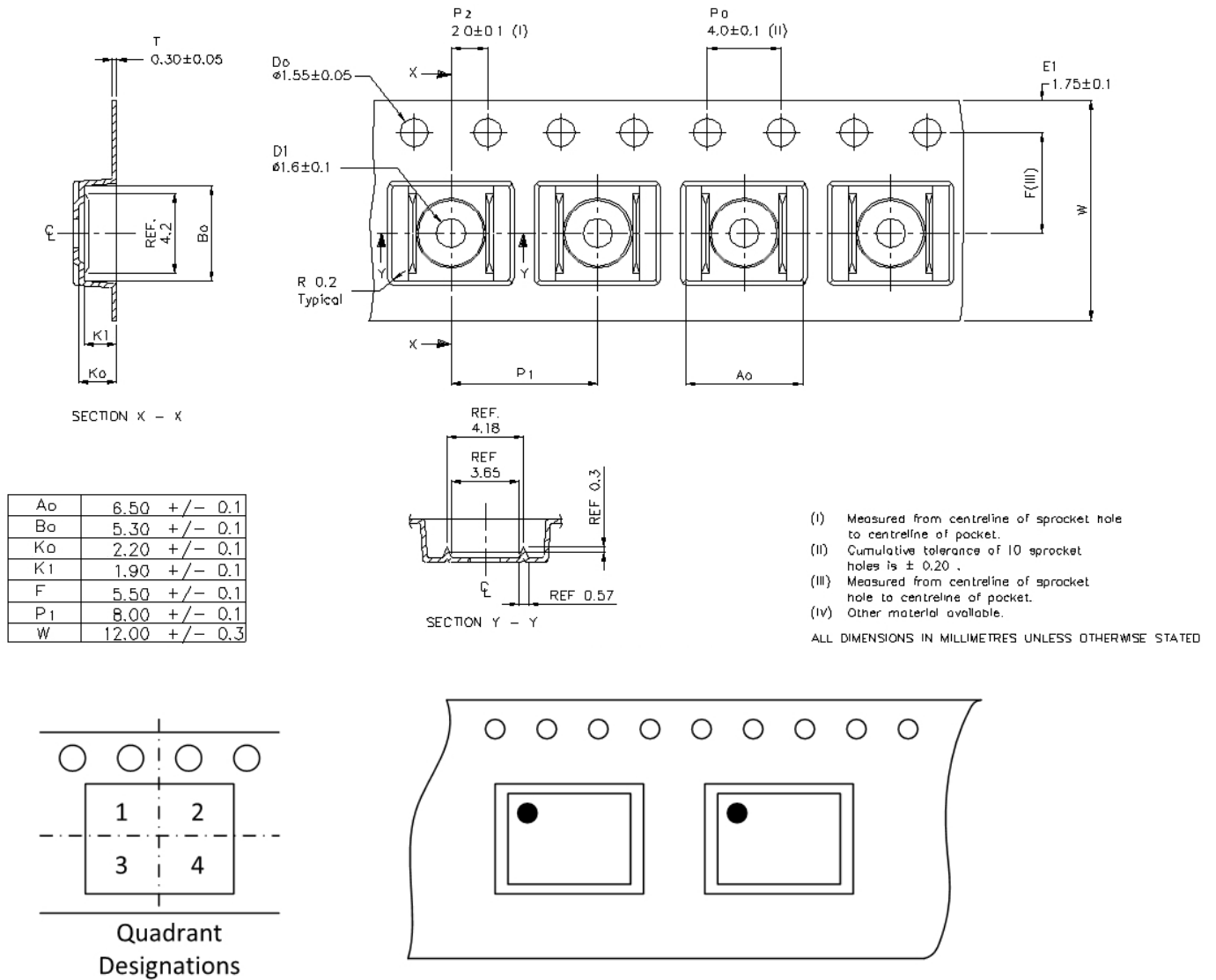
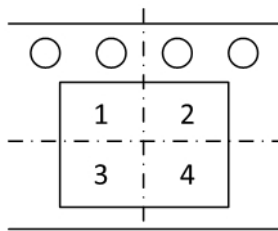
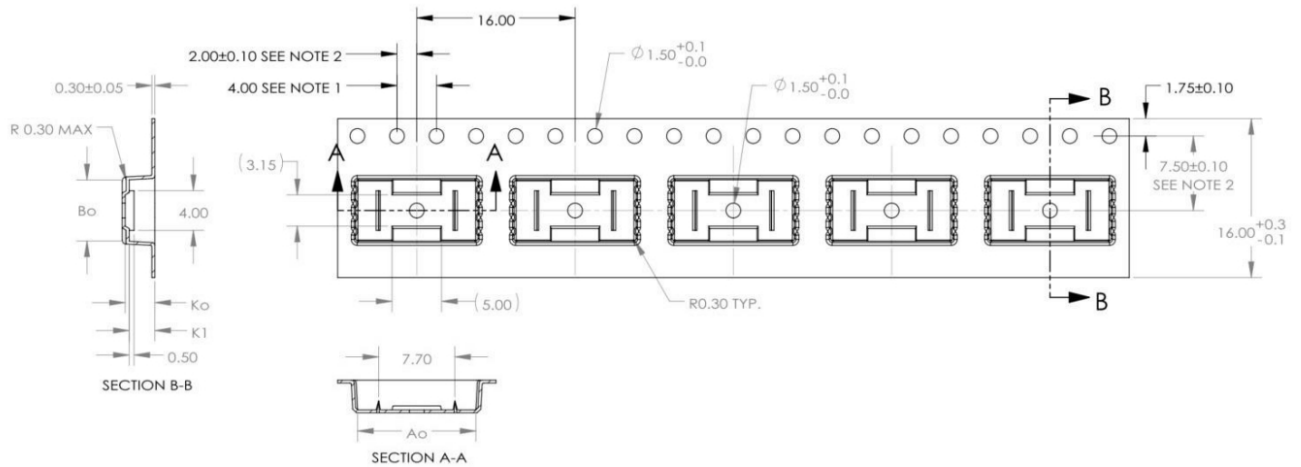

Figure 12.1 Tape and Reel Information of SOP8



Quadrant Designations

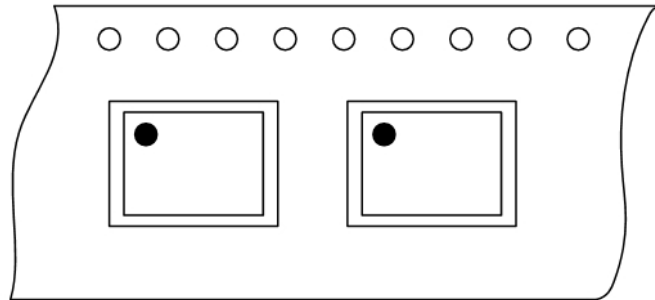
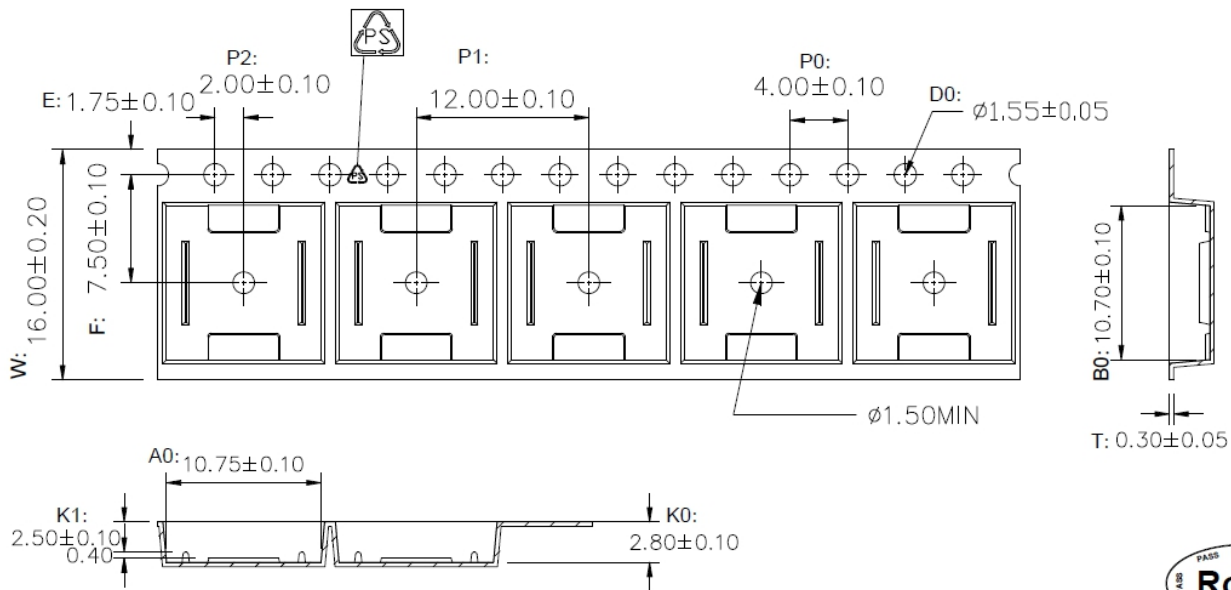

Figure 12.2 Tape and Reel Information of SOW8



1. 10 sprocket hole pitch cumulative tolerance ± 0.20 .
2. Carrier camber is within 1 mm in 250 mm.
3. Material : Black Conductive Polystyrene Alloy .
4. All dimensions meet EIA-481 requirements.
5. Thickness : 0.30 ± 0.05 mm.
6. Packing length per 22" reel : 378 Meters.(復巻 N=122)
7. Component load per 13" reel : 1000 pcs.
8. Surface resistivity : $10^5 \sim 10^{10} \Omega/\square$



W	16.00±0.20
A0	10.75±0.10
B0	10.70±0.10
K0	2.80±0.10
K1	2.50±0.10

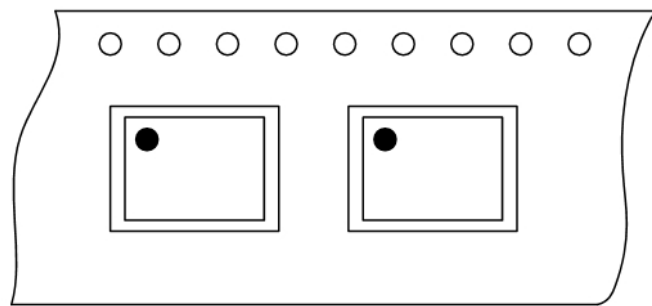
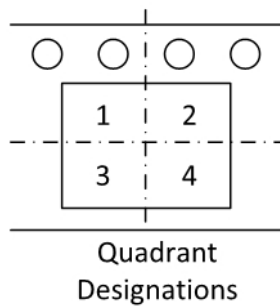

Figure 12.2 Tape and Reel Information of SOW16

13. Revision History

Revision	Description	Date
1.0	Initial version	2019/12/20
1.1	Update SOW8 package PIN description	2020/6/23
1.2	Changed tape and reel information	2021/2/4

X-ON Electronics

Largest Supplier of Electrical and Electronic Components

Click to view similar products for [Digital Isolators](#) category:

Click to view products by [NOVOSENSE](#) manufacturer:

Other Similar products are found below :

[SI8642EA-B-IU](#) [141E61](#) [140M31](#) [140E60](#) [122E61](#) [142E60](#) [163E60](#) [141E61Q](#) [140E61](#) [163M61](#) [120E30](#) [TDA51S485HC](#) [SSP5841ED](#)
[122M30](#) [122E31Q](#) [122E30Q](#) [220N31](#) [TPT7721-SO1R](#) [CA-IS3763LN](#) [CA-IS3980S](#) [CA-IS3742LN](#) [CA-IS3021S](#) [CA-IS3988P](#)
[CBMuD1201LAS8](#) [SCM3728ASA](#) [SCM3721ASA](#) [SSP5842ED](#) [ISO7721DR\(TOKMAS\)](#) [ADuM3201ARZ\(TOKMAS\)](#) [160M60](#) [120E30Q](#)
[161M31](#) [142E61](#) [140E31](#) [140M30](#) [141E60Q](#) [140M61](#) [160U31](#) [131M61](#) [121E30](#) [131E31S](#) [ADUM3300ARWZ-RL](#) [BL7121AH](#)
[BL7142WH](#) [BL7142WL](#) [CA-IS3762LN](#) [CA-IS3980P](#) [CA-IS3730LW](#) [CA-IS3722HG](#) [CA-IS3644HVW](#)