

RoHS Compliant Customer Drawing

REV.	ECN NO.	DESCRIPTION	DATE	DESIGN

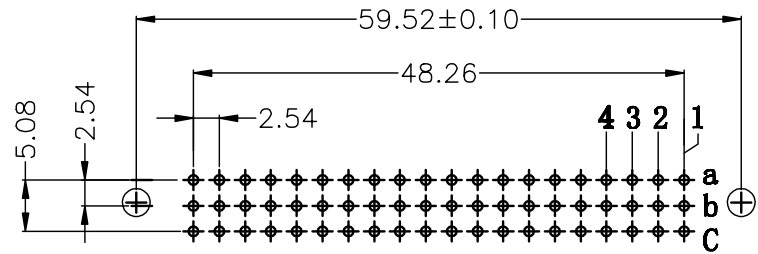
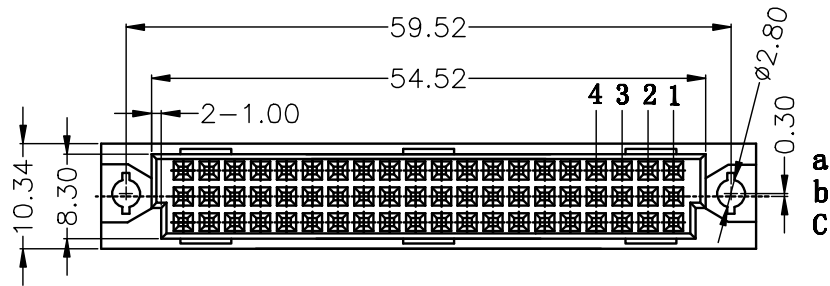
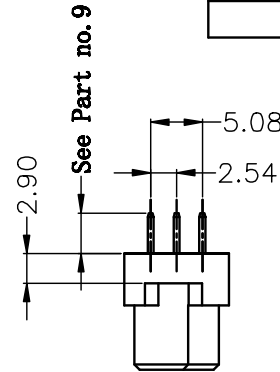
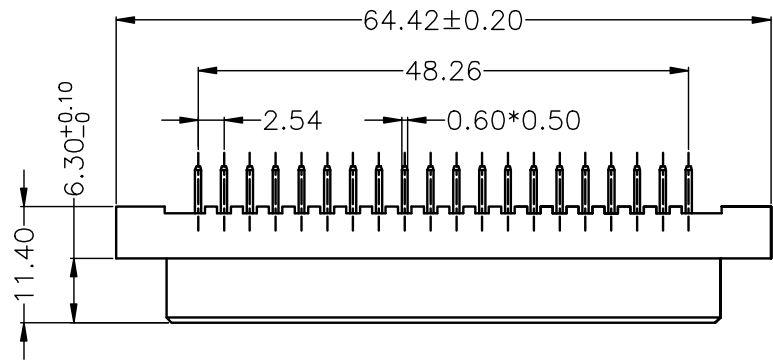

PCB LAYOUT(RECOMMENDED)
(TOP VIEW TOL. :±0.05)

SPECIFICATION

MATERIAL
 Housing:PBT+30%G.F UL94V-0
 Contacts:PhosPhor Bronze
CONTACT PLATING
 G=GOLD FLASH PLATED ALL OVER, NI UNDER PLATED ALL OVER.
 T=TIN PLATED ALL OVER, NI UNDER PLATED ALL OVER.
 S=GOLD FLASH PLATED ON CONTACT AREA, TIN PLATED ON SOLDER TAIL, NI UNDER PLATED ALL OVER.
 A=5u" (Selective) R=3u" (Selective)
 B=10u" (Selective) P=8u" (Selective)
 C=15u" (Selective) E=2u" (Semi-Gold Matte Tin)
 D=30u" (Selective) F=3u" (Semi-Gold Matte Tin)
 V=1u" (Selective) U=5u" (Semi-Gold Matte Tin)
 N=3u" (Gold)
ELECTRICAL
 Current rating: 2 Amps .
 Contact resistance: 20 mΩ initial
 Insulation resistance: 1000 MΩ min @ 500 VDC
 Dielectric withstanding voltage: 1000 VAC / minute
 Operating temperature: -40° C TO +105° C

Part no. A02 A - 060 F X S D A X X
 1 2 3 4 5 6 7 8 9 10

- | | |
|---|---|
| 1. SERIES NO. | 7. PROCESS OPTION: |
| 2. TYPE:
A=Standard | D=3*20 Housing (Male=90°
Female=180°) |
| 3. CONTACT NUMBER | 8. ROW SPACING:
A=2.54mm (a+b+c) |
| 4. CONTACT TYPE:
F=Female | 9. CONTACT LENGTH:
A=2.8mm
B=4.0mm
F=3.5mm |
| 5. CONTACT AREA PLATING:
SEE SPECIFICATION | 10. INSULATOR COLOR:
5=BEIGE
A=Champagne |
| 6. FUNCTION OPTION:
S-STRAIGHT | |

公差一览表 TOLERANCE UNLESS OTHERWISE				nextion® CONNECTOR		诺凌电子有限公司 NOXTLON ELECTRONIC CO.,LTD			
X.	±0.35	X*.	±5°	单位 UNITS	mm	制图 DRAWING	姚登攀	产品名称 NAME	欧式插座 360 0.5S型 180度 母座
.X	±0.30	.X*.	±2°	角法 VIEW	⊕	设计 DESIGN	姚登攀	产品料号 PART NO.	A02A-060FXSDAXX
.XX	±0.25	.XX*.	±1°	比例 SCALE	1:1	审核 CHECK		图号 DRAW NO.	A02A-060FXSDAXX-A0
.XXX	±0.02	.XXX*.	±0.5°	版本 VER	A0	核准 APPD			
DATE	2009.09.15								

RoHS Compliant Customer Drawing

REV.	ECN NO.	DESCRIPTION	DATE	DESIGN

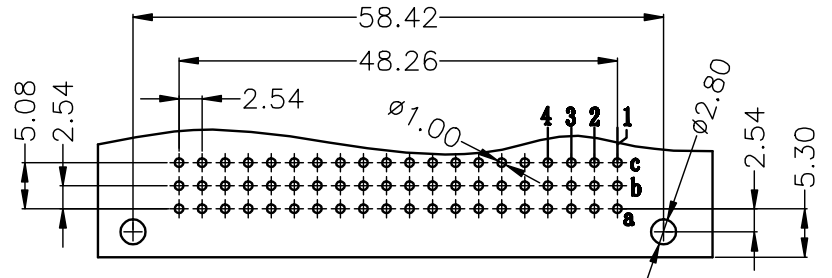
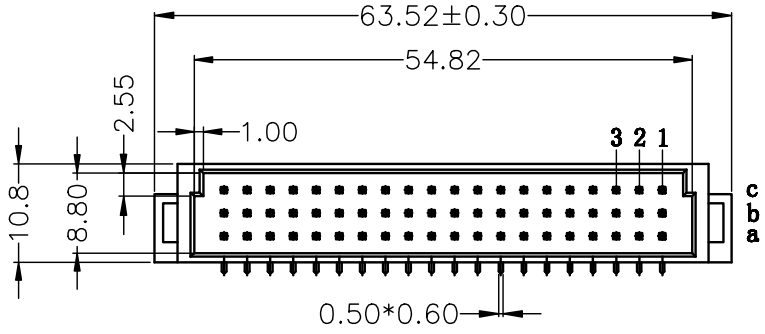
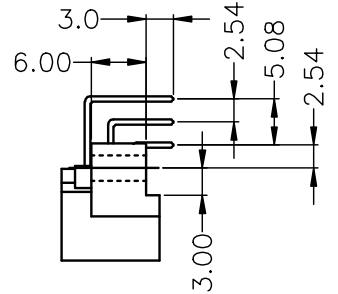
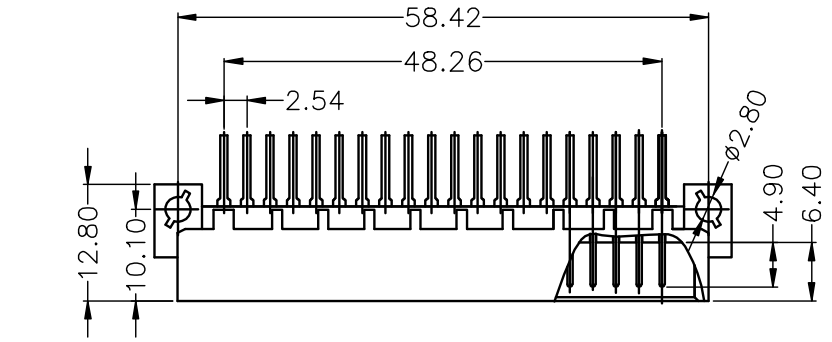

PCB LAYOUT(RECOMMENDED)
(TOP VIEW TOL. :±0.05)

SPECIFICATION

MATERIAL
Housing:PBT+30%G.F UL94V-0 Color:Champagne
Contacts:Brass
CONTACT PLATING
G= GOLD FLASH PLATED ALL OVER, NI UNDER PLATED ALL OVER.
T= TIN PLATED ALL OVER, NI UNDER PLATED ALL OVER.
S= GOLD FLASH PLATED ON CONTACT AREA, TIN PLATED ON SOLDER TAIL, NI UNDER PLATED ALL OVER.
A=5u" (Selective) R=3u" (Selective)
B=10u" (Selective) P=8u" (Selective)
C=15u" (Selective) E=2u" (Semi-Gold Matte Tin)
D=30u" (Selective) F=3u" (Semi-Gold Matte Tin)
V=1u" (Selective) U=5u" (Semi-Gold Matte Tin)
N=3u" (Gold)

ELECTRICAL

Current rating: 2 Amps .
Contact resistance: 20 mΩ initial
Insulation resistance: 1000 MΩ min @ 500 VDC
Dielectric withstanding voltage: 1000 VAC / minute
Operating temperature: -40° C TO +105° C

Part no. A02 A - 060 M X R D A E A
1 2 3 4 5 6 7 8 9 10

- SERIES NO.
- TYPE:
A=Standard
- CONTACT NUMBER
- CONTACT TYPE:
M=Male
- CONTACT AREA PLATING:
SEE SPECIFICATION
- FUNCTION OPTION:
R=Right angle
- PROCESS OPTION:
D=3*20 Housing (Male=90° Female=180°)
- ROW SPACING:
A=2.54mm(a+b+c)
- CONTACT LENGTH:
E=3.0mm(Right angle only)
- INSULATOR COLOR:
A=Champagne

公差一览表 TOLERANCE UNLESS OTHERWISE				nextion® CONNECTOR		诺凌电子有限公司 NOXTLON ELECTRONIC CO.,LTD			
X.	±0.35	X°.	±5°	单位 UNITS	mm	制图 DRAWING	管正志	产品名称 TMS	欧式插座 360 A型 90度 公座
.X	±0.30	.X°.	±2°	角法 VIEW	⊕	设计 DESIGN	管正志		
.XX	±0.25	.XX°.	±1°	比例 SCALE	1:1	审核 CHECK		产品料号 PART NO.	A02A-060MXRDAEA
.XXX	±0.02	.XXX°.	±0.5°	版本 VER	A0	核准 APPD		图号 DRAW NO.	A02A-060MXRDAEA-A0
DATE	2011.04.11								

X-ON Electronics

Largest Supplier of Electrical and Electronic Components

Click to view similar products for [Board to Board & Mezzanine Connectors](#) category:

Click to view products by [NOXTLON](#) manufacturer:

Other Similar products are found below :

[589158040000018](#) [MDF7C-18P-2.54DSA\(55\)](#) [FCN-268F036-G/BD](#) [FCN-268M012-G/0D](#) [FCN-268M024-G/1D](#) [FCN-723J004/1](#) [MIS-048-01-F-D-DP-K](#) [832-10-034-10-001000](#) [FX4C-80S-1.27DSA](#) [93696-330](#) [224393](#) [FCN-235D050-G/C](#) [210-93-314-41-105000](#) [2-22603-0](#) [MDF7-40DP-2.54DSA\(55\)](#) [5031084030](#) [MIT-114-03-F-D-K](#) [55323-1519](#) [45970-4130](#) [YFT-20-05-H-03-SB-K](#) [503308-3040](#) [026-6203-PDB](#) [027-6203-PDB](#) [069159702701000](#) [101A10019X](#) [105061100000861+](#) [55650-0588-C](#) [75140-7012](#) [87471-650](#) [YTW-30-07-H-Q-410-140](#) [YTT-112-01-H-Q](#) [063209](#) [0717420006](#) [FCN-268F024-G0D](#) [10124054-515LF](#) [68685-603](#) [8-1616154-3](#) [MIS-019-01-F-D](#) [YTQ-11201HQ](#) [IL-WX-10PB-HF-B-E1000E](#) [YFT-50-05-H-10-SB-K](#) [FCN-268M024-G/3D](#) [MDF7-16DP-2.54DSA\(55\)](#) [AXE810124](#) [FCN-214J100-G/0](#) [FCN-230C068-E/S](#) [AXE812124](#) [74220-001](#) [354184](#) [P50-028-DDS-TG](#)