







ZENER DIODES

Rated Voltage ±5%	P _D	NTE Number Axial Leads			NTE Number Stud Mount		Rated Voltage ±5%	P _D	NTE Number Axial Leads			NTE Number Stud Mount	
		1/2 Watt	1 Watt	5 Watt	10 Watt	50 Watt			1/2 Watt	1 Watt	5 Watt	10 Watt	50 Watt
2.4		5000A	5061A	-	-	-	28.0	5034A	5083A	5140A	5201A	5267A	
2.5		5001A	5062A	-	-	-	30.0	5035A	5084A	5141A	5202A	5268A	
2.7		5002A	5063A	-	-	-	33.0	5036A	147A	5142A	5203A	5269A	
2.8		5003A	5064A	-	-	-	36.0	5037A	5085A	5143A	5204A	5270A	
3.0		5004A	5065A	-	-	-	39.0	5038A	5086A	5144A	5205A	5271A	
3.3		5005A	5066A	5111A	-	-	43.0	5039A	5087A	5145A	5206A	5272A	
3.6		5006A	134A	5112A	-	-	45.0	-	-	-	5207A	5273A	
3.9		5007A	5067A	5113A	5174A	5240A	47.0	5040A	5088A	5146A	5208A	5274A	
4.3		5008A	5068A	5114A	5175A	5241A	50.0	-	-	-	5209A	5275A	
4.7		5009A	5069A	5115A	5176A	5242A	51.0	5041A	5089A	5147A	5210A	5276A	
5.1		5010A	135A	5116A	5177A	5243A	52.0	-	-	-	5211A	5277A	
5.6		5011A	136A	5117A	5178A	5244A	55.0	-	148A	-	-	-	
6.0		5012A	5070A	5118A	5179A	5245A	56.0	5042A	5090A	5148A	5212A	5278A	
6.2		5013A	137A	5119A	5180A	5246A	60.0	5043A	5091A	5149A	5213A	5279A	
6.8		5014A	5071A	5120A	5181A	5247A	62.0	5044A	149A	5150A	5214A	5280A	
7.5		5015A	138A	5121A	5182A	5248A	68.0	5045A	5092A	5151A	5215A	5281A	
8.2		5016A	5072A	5122A	5183A	5249A	75.0	5046A	5093A	5152A	5216A	5282A	
8.7		5017A	5073A	5123A	5184A	5250A	82.0	5047A	150A	5153A	5217A	5283A	
9.1		5018A	139A	5124A	5185A	5251A	87.0	5048A	5094A	5154A	5218A	-	
10.0		5019A	140A	5125A	5186A	5252A	91.0	5049A	5095A	5155A	5219A	5284A	
11.0		5020A	5074A	5126A	5187A	5253A	100.0	5050A	5096A	5156A	5220A	5285A	
11.5		-	141A	-	-	-	105.0	-	-	-	5221A	5286A	
12.0		5021A	142A	5127A	5188A	5254A	110.0	5051A	151A	5157A	5222A	5287A	
13.0		5022A	143A	5128A	5189A	5255A	120.0	5052A	5097A	5158A	5223A	5288A	
14.0		5023A	144A	5129A	5190A	5256A	130.0	5053A	5098A	5159A	5224A	5289A	
15.0		5024A	145A	5130A	5191A	5257A	140.0	5054A	5099A	5160A	5225A	5290A	
16.0		5025A	5075A	5131A	5192A	5258A	150.0	5055A	5100A	5161A	5226A	5291A	
17.0		5026A	5076A	5132A	5193A	5259A	160.0	5056A	5101A	5162A	5227A	5292A	
18.0		5027A	5077A	5133A	5194A	5260A	170.0	5057A	5102A	5163A	5228A	-	
19.0		5028A	5078A	5134A	5195A	5261A	175.0	-	-	-	5229A	5293A	
20.0		5029A	5079A	5135A	5196A	5262A	180.0	5058A	5103A	5164A	5230A	5294A	
22.0		5030A	5080A	5136A	5197A	5263A	190.0	5059A	5104A	5165A	5231A	5295A	
24.0		5031A	5081A	5137A	5198A	5264A	200.0	5060A	5105A	5166A	5232A	5296A	
25.0		5032A	5082A	5138A	5199A	5265A							
27.0		5033A	146A	5139A	5200A	5266A							
Pkg. Type							Pkg. Type						
Diag. No.		93	92	66	65	64	Diag. No.	93	92	66	65	64	
Pkg Style		DO35	DO41/DO15		DO4	DO5	Pkg Style	DO35	DO41/DO15		DO4	DO5	

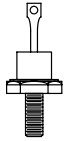
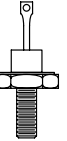
NOTE: 10 Watt and 50 Watt Zeners listed have Anode (Standard Polarity) connected to stud. Add suffix letter "K" to the NTE number for Cathode (Reverse Polarity) connected to stud (ex. NTE5175AK). The NTE type numbers shown have a standard tolerance for the Zener Voltage of ±5%.

See next page for 300mW Surface Mount types.

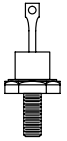
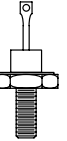
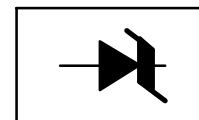

See Diagrams, beginning on Page 1-77

1/2 WATT ZENER DIODES

(1% TOLERANCE) (DO35 PACKAGE)

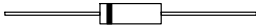
NTE Type No.	Nominal Zener Voltage (V)	Test Current (mA)	Maximum Junction Temperature	Package Style/Diag. No.
	V _Z @ I _{ZT}	I _{ZT}	°C	
5010T1	5.1 ± 1%	5	200	DO35 Diag. 93 
5011T1	5.6 ± 1%	5	200	
5013T1	6.2 ± 1%	5	200	
5019T1	10 ± 1%	5	200	
5021T1	12 ± 1%	5	200	

SURFACE MOUNT ZENER DIODES

NTE Type No.	Nominal Zener Voltage (V)	Test Current (mA)	Power Dissipation (mW)	NTE Type No.	Nominal Zener Voltage (V)	Test Current (mA)	Power Dissipation (mW)	Package Style/Diag. No.
	V _Z @ I _{ZT}	I _{ZT}	P _D		V _Z @ I _{ZT}	I _{ZT}	P _D	
5005SM	3.3 ± 5%	5	300	5014SM	6.8 ± 5%	5	300	SOT-23 Diag. 547d 
5006SM	3.6 ± 5%	5	300	5015SM	7.5 ± 5%	5	300	
5007SM	3.9 ± 5%	5	300	5018SM	9.1 ± 5%	5	300	
5008SM	4.3 ± 5%	5	300	5021SM	12 ± 5%	5	300	
5009SM	4.7 ± 5%	5	300	5024SM	15 ± 5%	5	300	
5010SM	5.1 ± 5%	5	300	5027SM	18 ± 5%	5	300	
5011SM	5.6 ± 5%	5	300	5031SM	24 ± 5%	5	300	
5013SM	6.2 ± 5%	5	300					

DIMENSIONAL OUTLINE DRAWINGS

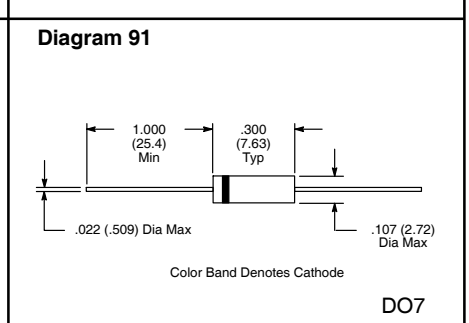
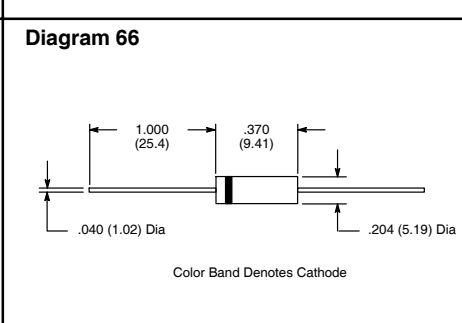
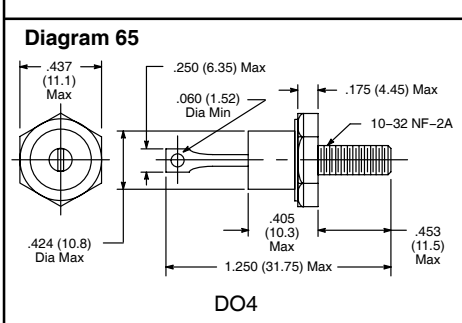
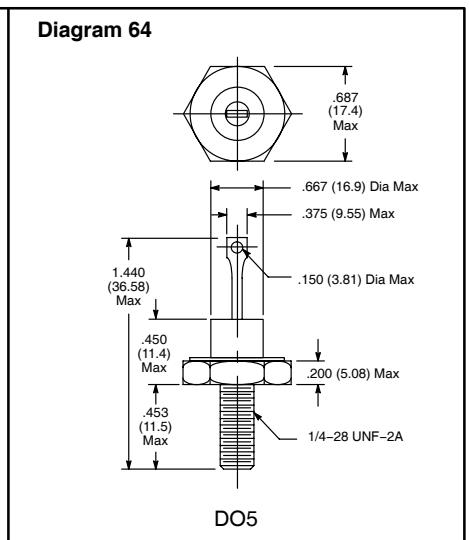
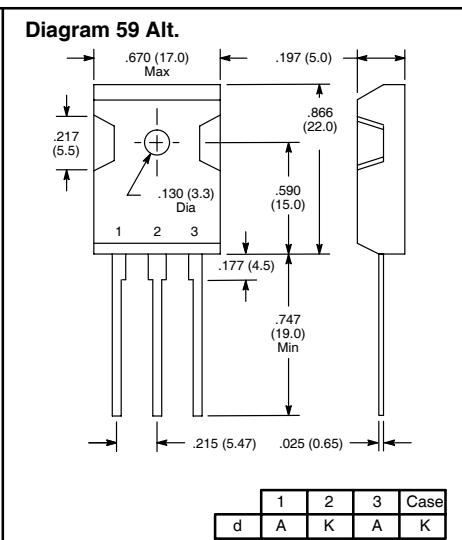
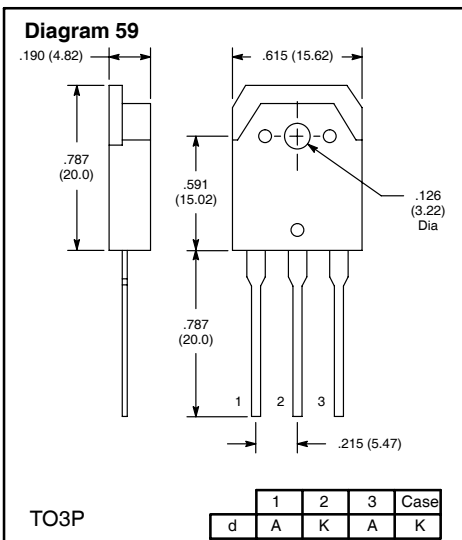

X-ON Electronics

Largest Supplier of Electrical and Electronic Components

Click to view similar products for [Zener Diodes](#) category:

Click to view products by [NTE](#) manufacturer:

Other Similar products are found below :

[RKZ13B2KG#P1](#) [DL5234B](#) [1N4682](#) [1N4691](#) [1N4693](#) [1N4732A](#) [1N4733A-TR](#) [1N4736A](#) [1N4750A](#) [1N4759ARL](#) [1N5241B](#) [1N5365B](#)
[1N5369B](#) [1N747A](#) [1N959B](#) [1N964B](#) [1N966B](#) [1N968B](#) [1N972B](#) [NTE149A](#) [NTE5121A](#) [NTE5147A](#) [NTE5152A](#) [NTE5155A](#) [NTE5164A](#)
[JANS1N4974US](#) [1N4692](#) [1N4700](#) [1N4702](#) [1N4704](#) [1N4711](#) [1N4714](#) [1N4737A](#) [1N4745ARL](#) [1N4752A](#) [1N4752ARL](#) [1N4760ARL](#)
[1N5221B](#) [1N5236B](#) [1N5241BTR](#) [1N5242BTR](#) [1N5350B](#) [1N5352B](#) [1N961BRR1](#) [1N964BRL](#) [RKZ5.1BKU#P6](#) [3SMAJ5950B-TP](#)
[3SMBJ5925B-TP](#) [TDZTR24](#) [441774C](#)