

AD-Series GMR Switch™ Precision Digital Magnetic Sensors

Functional Diagram

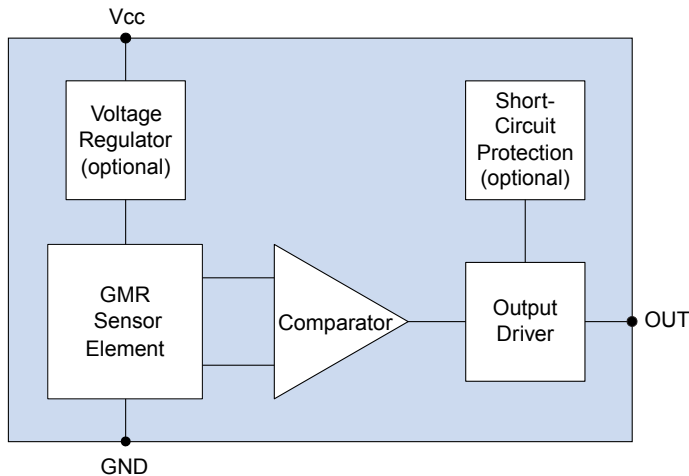

Features

- Digital outputs
- Precision magnetic operate points from 10 – 80 Oe
- 4.5 V – 30 V supply voltage
- 20 mA output drive
- Temperature and voltage stability
- Models available with short-circuit protection
- Frequency response to 100 kHz
- Ultraminiature TDFN6 and MSOP8 packages

Applications

- Motion, speed, and position control
- Pneumatic cylinder position sensing
- Speed sensing

Description

AD-Series GMR Switches are the industry standard for sensitivity and precision.

GMR Switches integrate GMR sensor elements with digital signal processing electronics. These sensors are more precise than other magnetic sensors, and magnetic field operate points are stable over voltage and temperature extremes.

AD-Series models available in a wide variety of magnetic operate points and output configurations. Versions are available with short-circuit protection circuitry and with integrated voltage regulators.

Idealized Transfer Function

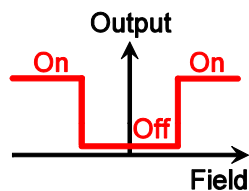

Absolute Maximum Ratings

Parameter	Symbol	Min.	Max.	Units	Test Conditions
Supply voltage	V _{CC}	–33	33	Volts	
		Except AD8xx/AD9xx AD8xx/AD9xx			
Output voltage		–0.5	33	Volts	
Output current (AD8xx/AD9xx only)			5	mA	
Operating temperature		–40	125	°C	
Storage temperature		–65	150	°C	
ESD			2000	Volts	Human Body Model
Applied magnetic field	H		Unlimited	Oe	

Operating Specifications

T _{min} to T _{max} ; 4.5 V < V _{CC} < 30 V unless otherwise stated.							
Parameter	Symbol	Min.	Typ.	Max.	Units	Test Conditions	
Supply voltage	V _{CC}	4.5		30	Volts		
Operating temperature	T _{MIN} ; T _{MAX}	–40		125	°C		
Magnetic operate point ADH025 AD004; AD021; AD621 AD024 AD005; AD022 AD006	H _{OP}	8	10	12	Oe		
		15	20	25			
		21	28	33			
		30	40	50			
		60	80	100			
Operate/release differential ADH025 AD004; AD021; AD621 AD024 AD005; AD022 AD006	H _{OP} –H _{REL}	2		8	Oe		
		5		14			
		5		15			
		5		25			
		5		50			
Supply current	I _{CC}	Except AD8xx/AD9xx AD8xx/AD9xx	2.5	4.5	mA	V _{CC} = 12V; Output Off	
			1.75	3.5			
Output current	I _{O-ON}	Except AD8xx/AD9xx AD8xx/AD9xx	20		mA	Output On	
			2				
Sinking output voltage	V _{OL}	Except AD8xx/AD9xx AD8xx/AD9xx		0.2	V	V _{CC} = 12V; I _O = 20mA	
				0.4		I _O = 2mA	
Sourcing output voltage	V _{OH}	Except AD8xx/AD9xx AD8xx/AD9xx		V _{CC} –2.5		V _{CC} = 12V; I _O = 20mA	
				V _{CC} –2		I _O = 2mA	
Output leakage current	I _{O-OFF}			10	µA	V _{CC} = 12V; Output Off	
Short-circuit voltage (AD8xx/AD9xx only)	V _{Short}	0.12		0.17	V	Output On	
Regulator output	V _{REG}	Except AD8xx/AD9xx		5.8	6.2	V	V _{CC} > 6.6V; 0 < I _{REG} < 20mA
			3.5	V _{CC} –0.9		V _{CC} < 6.6V	
		AD8xx/AD9xx		5.8	6	V	V _{CC} > 6.6V; 0 < I _{REG} < 20mA
			3.5	V _{CC} –0.9		V _{CC} < 6.6V	
Regulator output current (AD4xx – AD9xx)	I _{REG}	3			mA		
Frequency response	f _{MAX}	100			kHz		
Junction–Ambient Thermal Resistance	θ _{JA}		320		°C/W	Soldered to double-sided board; free air	

Operation

Typical connections with an external pull-up resistor are shown below:

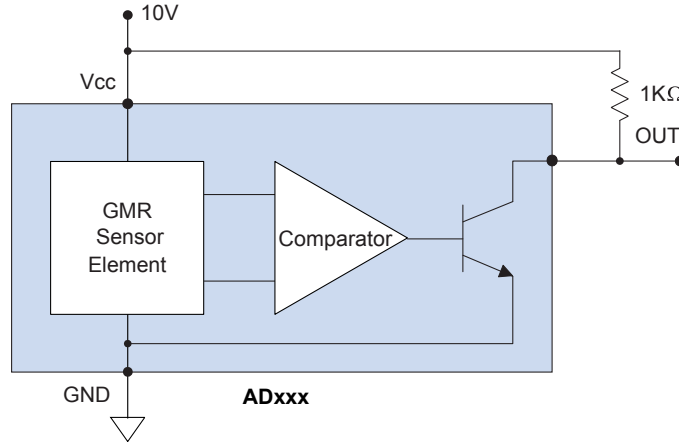

Figure 1. Typical connections.

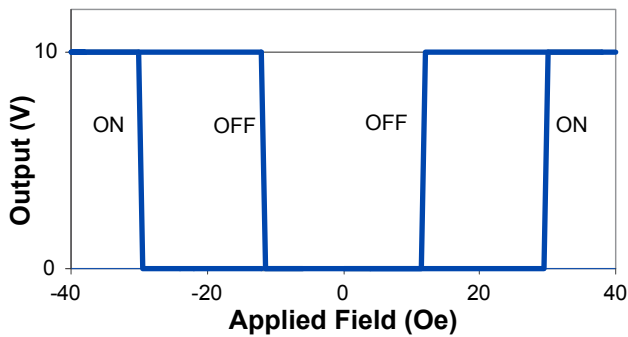

Figure 2a. Typical output vs. magnetic field (AD024 with a 10V supply and 1 KΩ pull-up resistor).

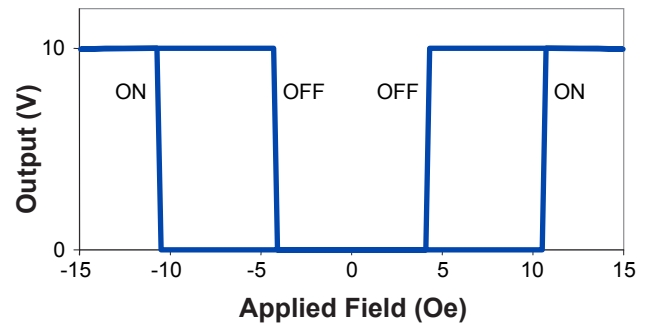

Figure 2b. Typical output vs. magnetic field (ADH025 with a 10V supply and 1 KΩ pull-up resistor).

ON / OFF Behavior

AD-Series sensor outputs turn ON when the field exceeds the magnetic operate point, and OFF when the field drops below the operate point minus the release differential.

External Pull-Up Resistors

Outputs are open collector, with PNP output transistors for sourcing versions and NPN transistors for sinking versions. Outputs should have external pull-up or pull-down resistors. For microcontroller interfaces, the microcontroller’s input pull-up resistors can be activated.

Omnipolar

GMR Switches are “omnipolar,” which means the outputs turn ON when a magnetic field of either magnetic polarity is applied.

In-Plane Magnetic Sensitivity

As the field varies in intensity, the digital output will turn on and off. Unlike Hall-effect or other sensors, the direction of sensitivity is in the plane of the package. The diagrams below show two permanent magnet orientations that will activate the sensor in the direction of sensitivity:

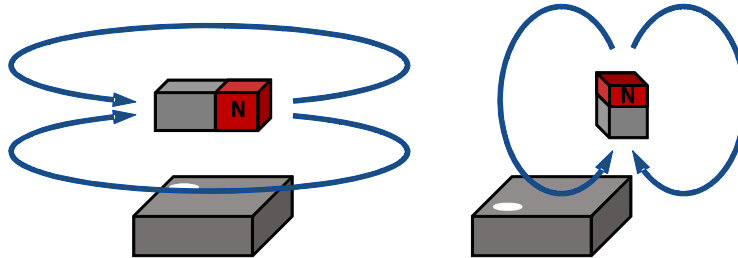

Figure 3. Planar magnetic sensitivity.

Standard and Cross-Axis Sensitivity

Standard AD-Series sensors are sensitive along the part axis as shown in Figure 4b, but a number of versions are available with cross-axis sensitivity (see Figure 4a).



Figure 4a.
Cross-axis sensitivity.

Figure 4b.
Standard sensitivity.

Typical Operation

A typical proximity sensor using an AD022 cross-axis sensor and magnet is shown in the figures below. This sensor has a 40 Oe typical operate point, and actuates with the magnet approximately 0.375 inches (9 mm) from the center of the sensor. Because the sensor is omnipolar, it will operate with either a north or south magnet face.

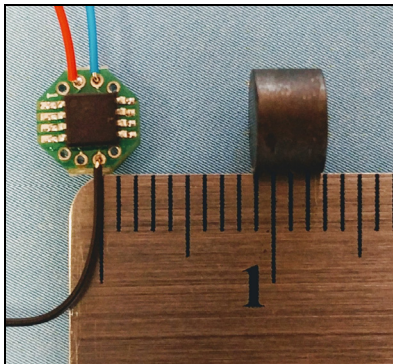

Figure 5. An AD022 sensor (pin 1 is upper left; the sensor has cross-axis sensitivity), on an AG015 circuit board with a 12031 8 mm dia. x 3 mm thick ferrite magnet.

**Sensor actuates at approx. 9 mm distance.
Red wire = V_{CC}; Blk = GND; Blue = OUT (Sink).**

More sensitive sensors with lower magnetic operate points (such as the 10 Oe ADH025-00E) operate with the magnet farther away. Stronger or larger magnets will also increase the operate distance. Our most sensitive digital sensor (the AFL006; see [AFL-Series sensor datasheet](#)) has been demonstrated to operate with a rare-earth magnet at an air gap of two inches (50 mm) or more.

We have a free, Web-based application that provides fields and operate distances for various sensor and magnet types:

www.nve.com/spec/calculators.php

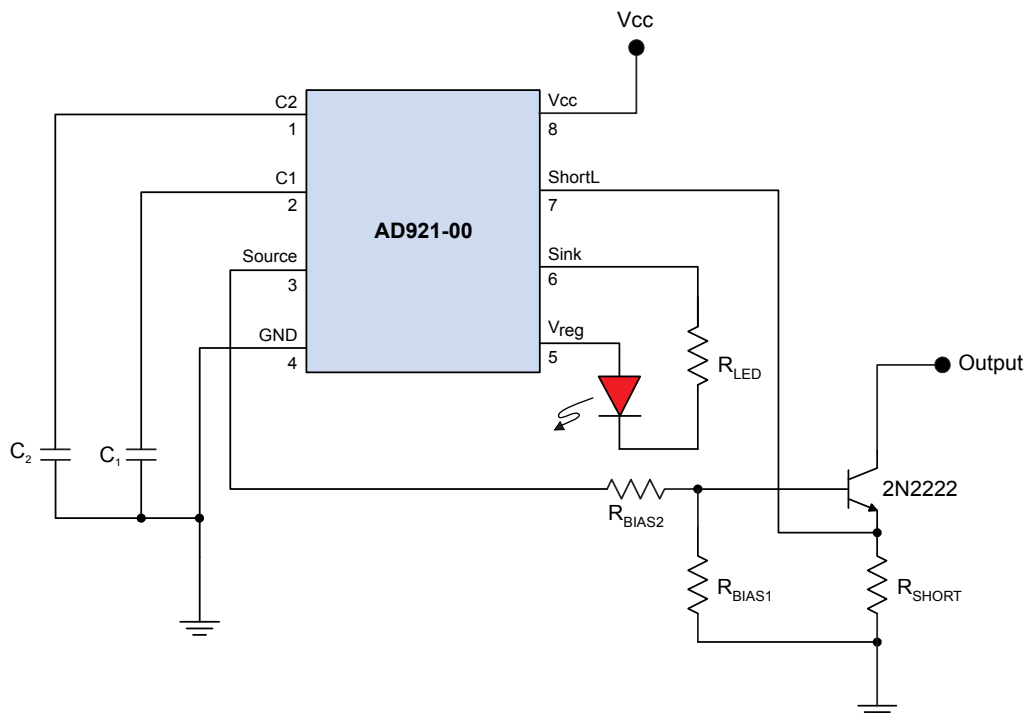

Figure 7. Short-circuit protection circuitry (sinking output).

If the voltage across R_{SHORT} exceeds 145 mV (typical), the SCP circuitry is activated. An R_{SHORT} of 0.47Ω then results in a protection threshold of approximately 300 mA.

Capacitor C_2 delays the shutdown so normal startup transients do not trigger the circuitry; a $0.001\ \mu\text{F}$ capacitor can be used for a typical $35\ \mu\text{s}$ delay (t_2). C_1 sets the SCP “OFF” time (t_1), which is typically $0.01\ \mu\text{F}$ for 15 ms OFF time.

The short-circuit output current using these typical component values is shown below:

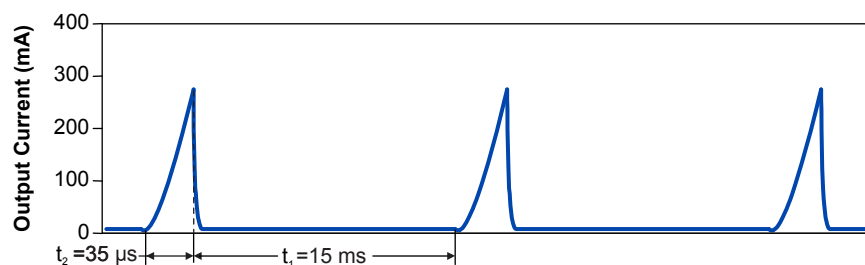

Figure 8. AD821 / AD921 output current with typical SCP components and output shorted (see Figures 5 and 6 for circuits).

R_{BIAS1} and R_{BIAS2} bias the output transistor. Typical values for are $16\ \text{K}\Omega$ for R_{BIAS1} and $3\ \text{K}\Omega$ for R_{BIAS2} , which provides 1 mA of transistor base current. R_{LED} sets the LED current up to a maximum of 3 mA.

External Short-Circuit Protection

NVE offers a separate Power Switch IC, the DB001-00, for sensor Short Circuit Protection of sensors that do not have SCP support. The DB001 also provides a high-current output, reverse battery protection, and transient protection.

A typical circuit is as follows:

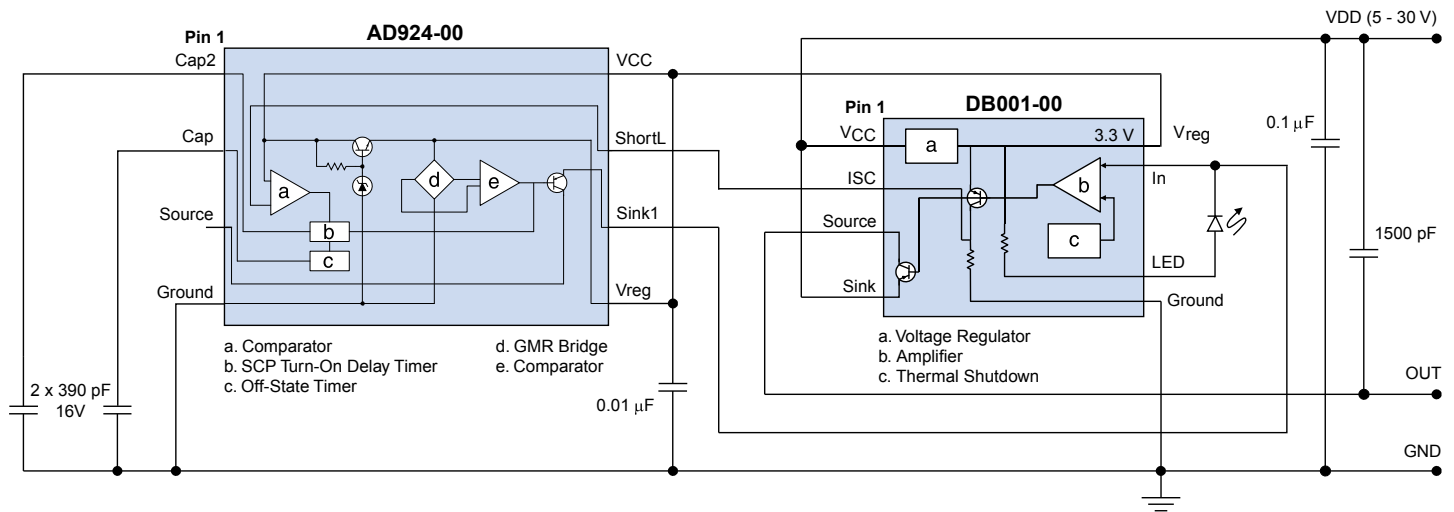

Figure 9. A GMR Switch with an external power switch IC for a high-power output, bullet-proof system.

Typical Performance Graphs

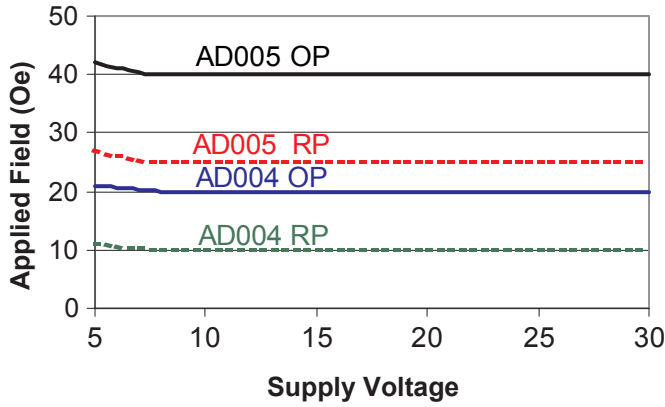

Figure 10. Typical Operate Points (OP) and Release Points (RP) vs. supply voltage (25°C).

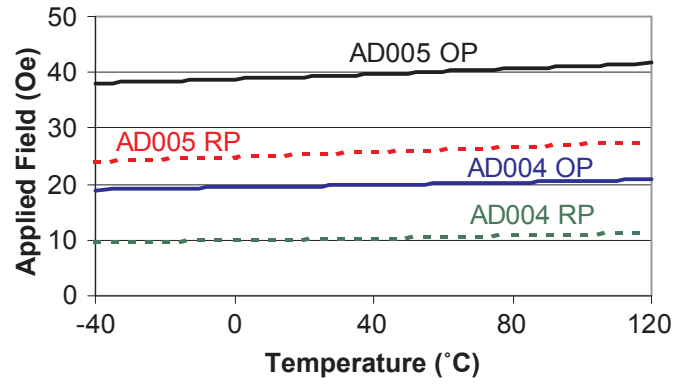

Figure 11. Typical Operate Points (OP) and Release Points (RP) vs. temperature.

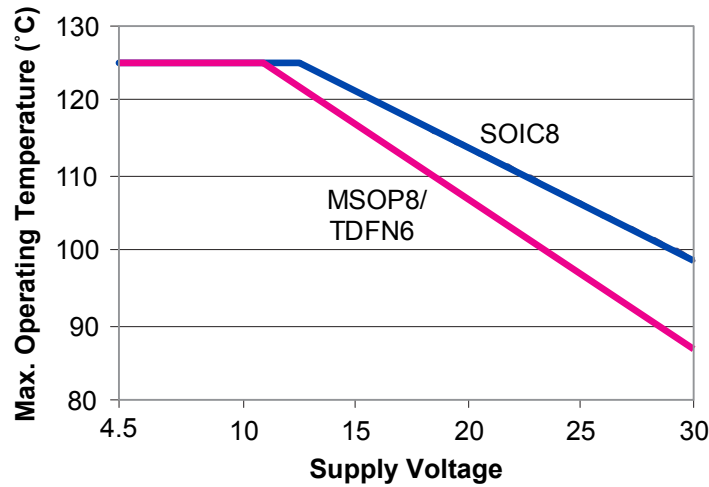

Figure 12. Operating temperature derating (free air).

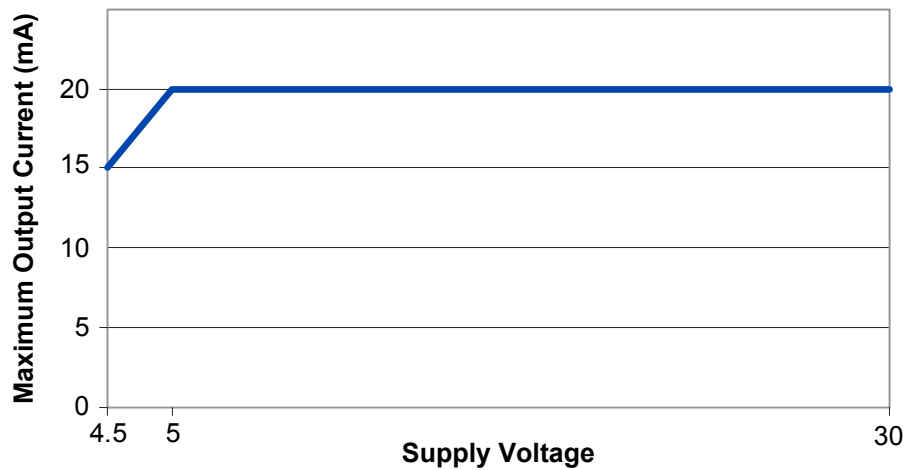
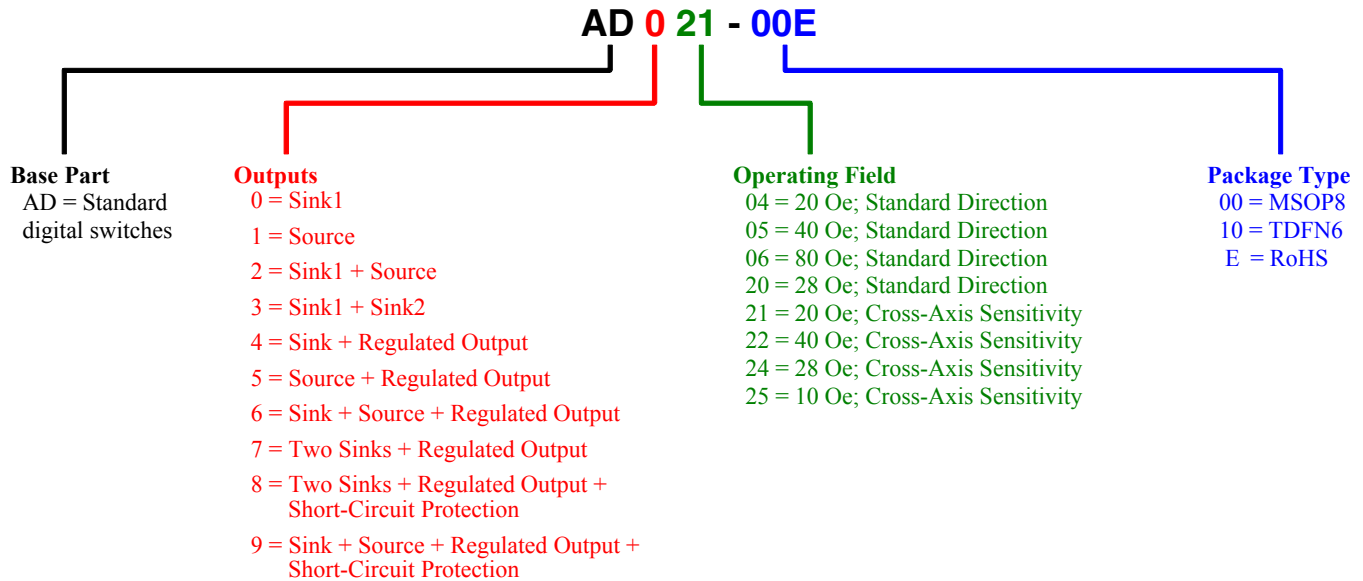

Figure 13. Output current vs. supply voltage.

Part Numbering



Pinouts

MSOP GMR Switches Without Short-Circuit Protection (AD0xx-00 – AD7xx-00; ADH0xx-00):

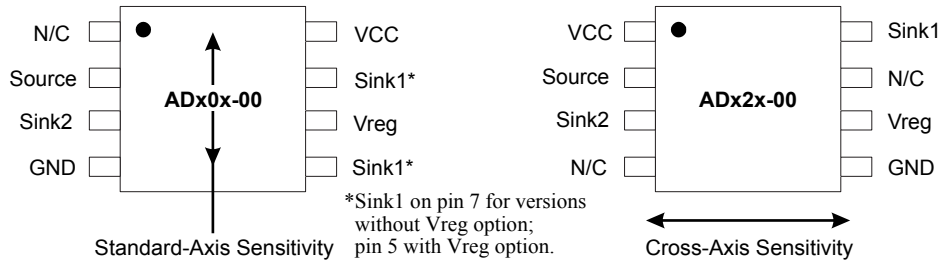

MSOP GMR Switches With Short-Circuit Protection (AD8xx-00 – AD9xx-00):

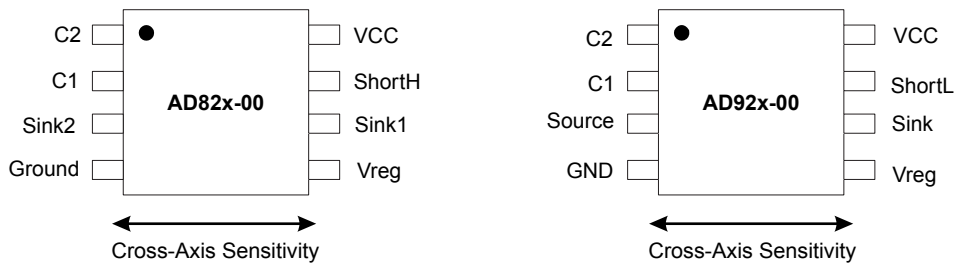

TDFN GMR Switches (AD0xx-10):

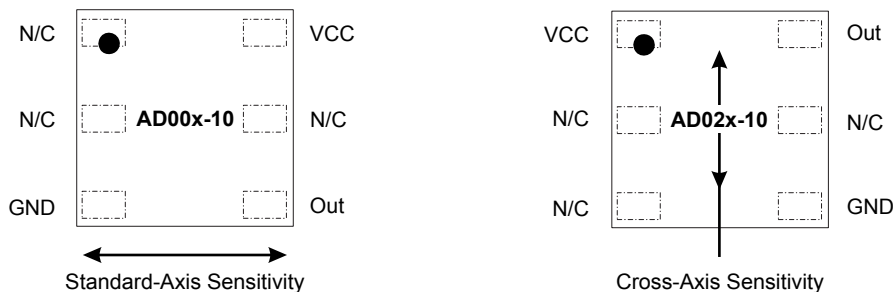

Operating Point Chart

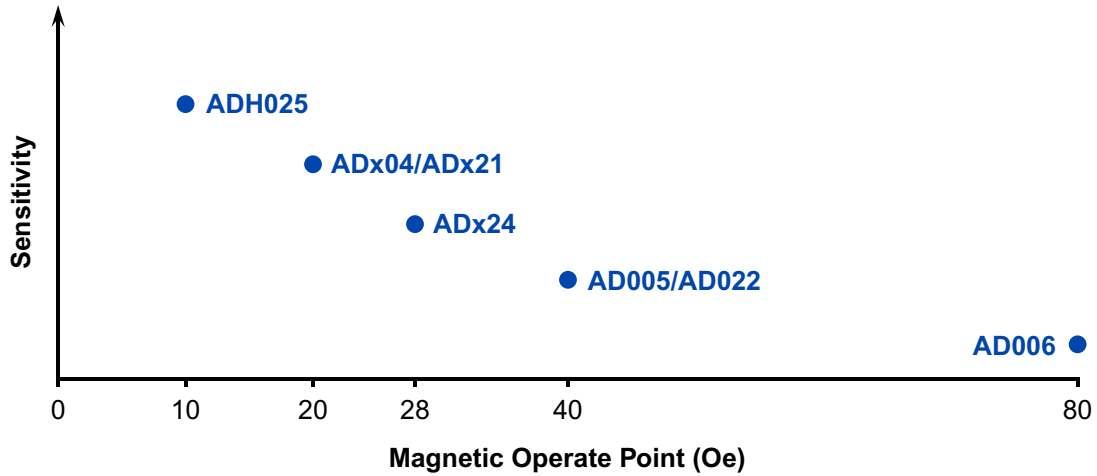

Stock Parts

Available Part	Operate Point (typ.)	Release Point (typ.)	Output Configuration	Max. Operating Temperature	Package
AD004-00E	20 Oe	10 Oe	Sink	125°C	MSOP8
AD005-00E	40 Oe	25 Oe	Sink	125°C	MSOP8
AD006-00E	80 Oe	50 Oe	Sink	125°C	MSOP8
AD021-00E	20 Oe	10 Oe	Sink	125°C	MSOP8
AD022-00E	40 Oe	25 Oe	Sink	125°C	MSOP8
AD024-00E	28 Oe	14 Oe	Sink	125°C	MSOP8
AD024-10E	28 Oe	14 Oe	Sink	125°C	TDFN6
AD621-00E	20 Oe	10 Oe	Sink+Source	125°C	MSOP8
AD824-00E	28 Oe	14 Oe	2 Sinks + Short-Circuit Protection	150°C	MSOP8
ADH025-00E	10 Oe	5 Oe	Sink	150°C	MSOP8

Evaluation Kits

Two inexpensive evaluation kits including AD-Series GMR switches are available:

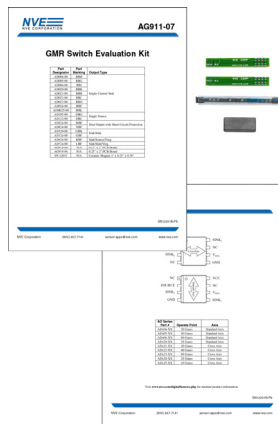

AG910-07/AG911-07—GMR Switch Evaluation Kits

Several GMR Switches with different magnetic operate points and different output options such as current sink and current source. Magnets and circuit boards for mounting the parts are also included. The AG910-07 kit also includes a zero insertion force (ZIF) socket for easy testing of the MSOP-packaged sensors.

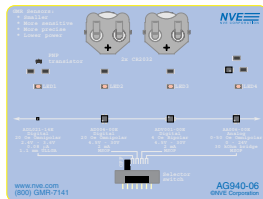

AG940-07E: Digital/Analog/Omnipolar/Bipolar Sensor Demo Board

The kit includes a demo board with our most popular digital, analog, omnipolar, and bipolar sensors, including an AD004-00 digital sensor. Each sensor drives an indicator LED. A bar magnet is included so you can see for yourself how the sensors work. The evaluation boards are 3.75 by 5 inches (95 mm by 127 mm), and are powered by two coin cells (included).

Bare Circuit Boards for Sensors

NVE offers several bare circuit boards specially designed for easy connections to surface-mount sensors. Popular PCBs are shown below (images are **two times** actual size):

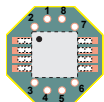

AG915-06:
0.25" (6 mm) octagonal
MSOP8



AG918-06 (standard) / AG919-06 (cross-axis):
2" x 0.25" (50 mm x 6 mm) MSOP8



AG035-06:
1.57" x 0.25" (40 mm x 6 mm) TDFN6

Package Drawings

TDFN6 (-10 suffix)

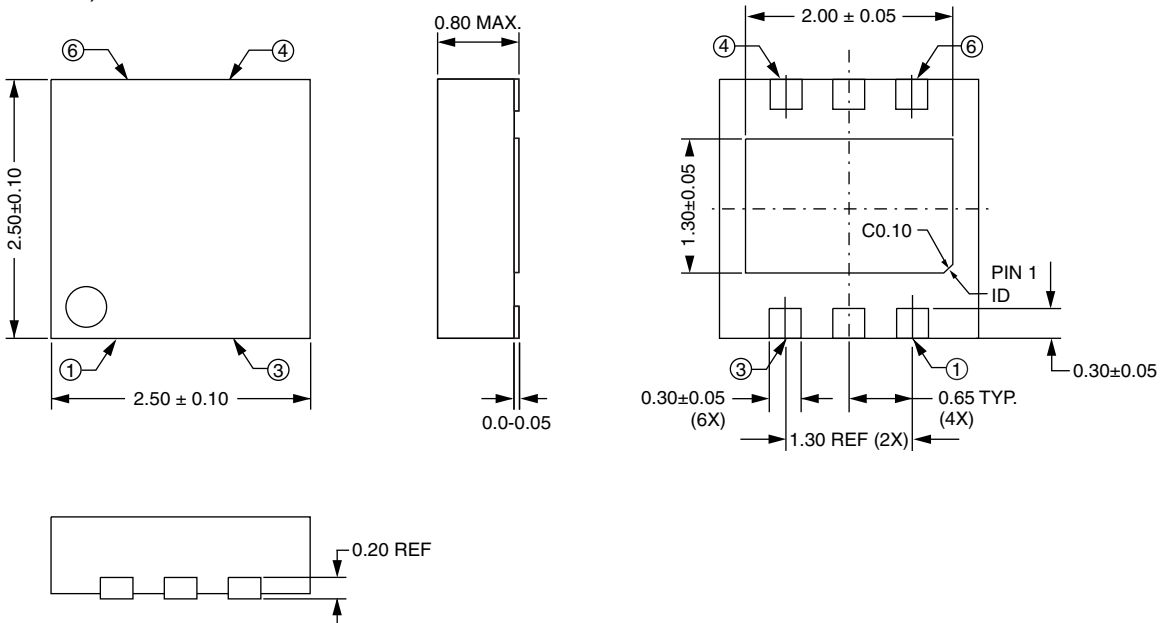

MSOP8 (-00 suffix)

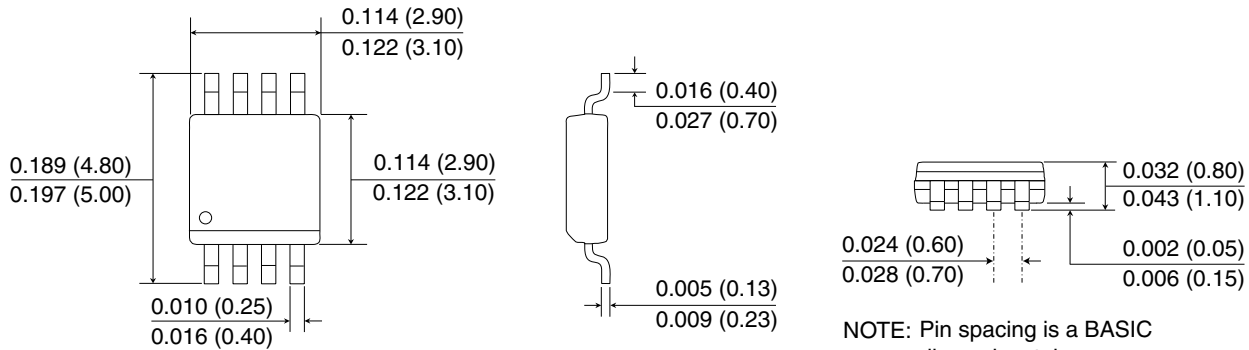

NOTE: Pin spacing is a BASIC dimension; tolerances do not accumulate

Soldering profiles per JEDEC J-STD-020C, MSL1



Revision History

SB-00-060-D

October 2017

Change

- Added description and image for “Typical Operation” (p. 4).
- Changed pin 5 of AD00x-10 drawing to “NC” instead of “Test” (p. 9).
- Added Operating Point Chart (p. 10).
- Added Evaluation Kits and bare circuit boards (p. 11).

SB-00-060-C

September 2017

Change

- Added AD006 (80 Oe GMR Switch).
- Misc. cosmetic changes.

SB-00-060-B

August 2017

Change

- Eliminated SOIC package option.
- Misc. cosmetic changes.

SB-00-060-A

March 2017

Change

- Initial datasheet release superseding catalog.

Datasheet Limitations

The information and data provided in datasheets shall define the specification of the product as agreed between NVE and its customer, unless NVE and customer have explicitly agreed otherwise in writing. All specifications are based on NVE test protocols. In no event however, shall an agreement be valid in which the NVE product is deemed to offer functions and qualities beyond those described in the datasheet.

Limited Warranty and Liability

Information in this document is believed to be accurate and reliable. However, NVE does not give any representations or warranties, expressed or implied, as to the accuracy or completeness of such information and shall have no liability for the consequences of use of such information.

In no event shall NVE be liable for any indirect, incidental, punitive, special or consequential damages (including, without limitation, lost profits, lost savings, business interruption, costs related to the removal or replacement of any products or rework charges) whether or not such damages are based on tort (including negligence), warranty, breach of contract or any other legal theory.

Right to Make Changes

NVE reserves the right to make changes to information published in this document including, without limitation, specifications and product descriptions at any time and without notice. This document supersedes and replaces all information supplied prior to its publication.

Use in Life-Critical or Safety-Critical Applications

Unless NVE and a customer explicitly agree otherwise in writing, NVE products are not designed, authorized or warranted to be suitable for use in life support, life-critical or safety-critical devices or equipment. NVE accepts no liability for inclusion or use of NVE products in such applications and such inclusion or use is at the customer's own risk. Should the customer use NVE products for such application whether authorized by NVE or not, the customer shall indemnify and hold NVE harmless against all claims and damages.

Applications

Applications described in this datasheet are illustrative only. NVE makes no representation or warranty that such applications will be suitable for the specified use without further testing or modification.

Customers are responsible for the design and operation of their applications and products using NVE products, and NVE accepts no liability for any assistance with applications or customer product design. It is customer's sole responsibility to determine whether the NVE product is suitable and fit for the customer's applications and products planned, as well as for the planned application and use of customer's third party customers. Customers should provide appropriate design and operating safeguards to minimize the risks associated with their applications and products.

NVE does not accept any liability related to any default, damage, costs or problem which is based on any weakness or default in the customer's applications or products, or the application or use by customer's third party customers. The customer is responsible for all necessary testing for the customer's applications and products using NVE products in order to avoid a default of the applications and the products or of the application or use by customer's third party customers. NVE accepts no liability in this respect.

Limiting Values

Stress above one or more limiting values (as defined in the Absolute Maximum Ratings System of IEC 60134) will cause permanent damage to the device. Limiting values are stress ratings only and operation of the device at these or any other conditions above those given in the recommended operating conditions of the datasheet is not warranted. Constant or repeated exposure to limiting values will permanently and irreversibly affect the quality and reliability of the device.

Terms and Conditions of Sale

In case an individual agreement is concluded only the terms and conditions of the respective agreement shall apply. NVE hereby expressly objects to applying the customer's general terms and conditions with regard to the purchase of NVE products by customer.

No Offer to Sell or License

Nothing in this document may be interpreted or construed as an offer to sell products that is open for acceptance or the grant, conveyance or implication of any license under any copyrights, patents or other industrial or intellectual property rights.

Export Control

This document as well as the items described herein may be subject to export control regulations. Export might require a prior authorization from national authorities.

Automotive Qualified Products

Unless the datasheet expressly states that a specific NVE product is automotive qualified, the product is not suitable for automotive use. It is neither qualified nor tested in accordance with automotive testing or application requirements. NVE accepts no liability for inclusion or use of non-automotive qualified products in automotive equipment or applications.

In the event that customer uses the product for design-in and use in automotive applications to automotive specifications and standards, customer (a) shall use the product without NVE's warranty of the product for such automotive applications, use and specifications, and (b) whenever customer uses the product for automotive applications beyond NVE's specifications such use shall be solely at customer's own risk, and (c) customer fully indemnifies NVE for any liability, damages or failed product claims resulting from customer design and use of the product for automotive applications beyond NVE's standard warranty and NVE's product specifications.

An ISO 9001 Certified Company

NVE Corporation
11409 Valley View Road
Eden Prairie, MN 55344-3617 USA
Telephone: (952) 829-9217
www.nve.com
www.youtube.com/NveCorporation

e-mail: sensor-info@nve.com

©NVE Corporation
All rights are reserved. Reproduction in whole or in part is prohibited without the prior written consent of the copyright owner.

SB-00-060_RevD

October 2017

X-ON Electronics

Largest Supplier of Electrical and Electronic Components

Click to view similar products for [Industrial Hall Effect/Magnetic Sensors](#) category:

Click to view products by [NVE](#) manufacturer:

Other Similar products are found below :

[GT-14114](#) [GT-14123](#) [GTN2C15C](#) [GT-12076](#) [GT-14049](#) [GT-14067](#) [GT-14132](#) [GT-18030](#) [MZ07A108](#) [PST360G2-1S-C0000-ERA360-05K](#)
[MZC1-2V2PS-KP0](#) [PSC360G2-F1P-C0000-ERA360-05K-200](#) [115L 9E 502 W06017](#) [115L 5,2E 502 W06017](#) [115L 14E 502 W06017](#)
[103SR14A-1](#) [55100-3H-04-A](#) [MZT7-03VPS-KW0](#) [MZT8-03VPS-KW0](#) [A1326LLHLT-T](#) [ACS770LCB-100U-PFF-T](#) [55505-00-02-B](#) [GN](#)
[55.2-ND-15-3](#) [GN 55.2-ND-18-3](#) [GN 55.2-ND-4-3](#) [GN 55.2-ND-8-3](#) [GN 55.2-SC-10-3](#) [GN 55.4-ND-10-7,5-2](#) [GN 55.4-ND-12-9,5-2,5](#) [GN](#)
[55.4-ND-26-20,3-5](#) [GN 55.4-ND-7,5-4-1,5](#) [101MG7-BP](#) [103SR18-1](#) [A1324LUA-T](#) [MXM1120KIT](#) [MXM1120SOKIT](#) [AA006-02E](#) [55140-](#)
[3H-03-A](#) [55100-2M-02-A](#) [MM12-60APS-ZUK](#) [ACX04-F99-I-V15](#) [GN 55.1-SC-24-11.5-4](#) [MZA70155](#) [MZR40158](#) [PW520000](#) [MZT7-](#)
[03VPS-KP0](#) [MZT8-03VPS-KR0](#) [MZT8-03VPS-KP0](#) [RZT7-03ZRS-KP0](#) [RZT7-03ZRS-KW0](#)