



RF Power LDMOS Transistor

High Ruggedness N-Channel Enhancement-Mode Lateral MOSFET

Designed for handheld two-way radio applications with frequencies from 136 to 941 MHz. The high gain, ruggedness and wideband performance of this device make it ideal for large-signal, common-source amplifier applications in handheld radio equipment.

Wideband Performance (In 350–520 MHz reference circuit, 7.5 Vdc, $T_A = 25^\circ\text{C}$, CW)

Frequency (MHz) ⁽¹⁾	P_{in} (W)	G_{ps} (dB)	η_D (%)	P_{out} (W)
350	0.25	15.2	56.6	8.4
435	0.25	15.5	61.5	8.9
520	0.25	15.0	64.2	7.9

Narrowband Performance (7.5 Vdc, $T_A = 25^\circ\text{C}$, CW)

Frequency (MHz)	G_{ps} (dB)	η_D (%)	P_{out} (W)
520 ⁽²⁾	20.7	73.9	8.4

Load Mismatch/Ruggedness

Frequency (MHz)	Signal Type	VSWR	P_{in} (dBm)	Test Voltage	Result
520 ⁽²⁾	CW	> 65:1 at all Phase Angles	21 (3 dB Overdrive)	10.8	No Device Degradation

1. Measured in 350–520 MHz UHF broadband reference circuit (page 5).
2. Measured in 520 MHz narrowband RF test fixture (page 9).

Features

- Characterized for operation from 136 to 941 MHz
- Unmatched input and output allowing wide frequency range utilization
- Integrated ESD protection
- Integrated stability enhancements
- Wideband — full power across the band
- Exceptional thermal performance
- Extreme ruggedness
- High linearity for: TETRA, SSB

Typical Applications

- Output stage VHF band handheld radio
- Output stage UHF band handheld radio
- Output stage for 700–800 MHz handheld radio

AFM907N

136–941 MHz, 8 W, 7.5 V
**WIDEBAND
 AIRFAST RF POWER LDMOS
 TRANSISTOR**

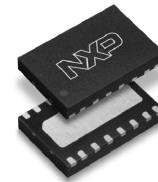

DFN 4 × 6

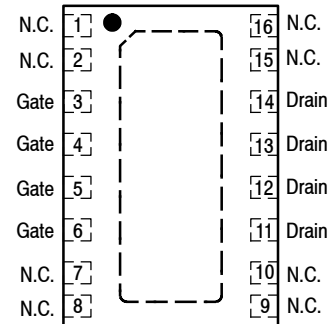

(Top View)

Note: Exposed backside of the package is the source terminal for the transistor.

Figure 1. Pin Connections

Table 1. Maximum Ratings

Rating	Symbol	Value	Unit
Drain-Source Voltage	V_{DSS}	-0.5, +30	Vdc
Gate-Source Voltage	V_{GS}	-6.0, +12	Vdc
Operating Voltage	V_{DD}	0 to 12.5	Vdc
Storage Temperature Range	T_{stg}	-65 to +150	°C
Case Operating Temperature Range	T_C	-40 to +150	°C
Operating Junction Temperature (1,2)	T_J	-40 to +150	°C
Total Device Dissipation @ $T_C = 25^\circ\text{C}$ Derate above 25°C	P_D	65.7 0.52	W W/°C

Table 2. Thermal Characteristics

Characteristic	Symbol	Value (2,3)	Unit
Thermal Resistance, Junction to Case Case Temperature 79°C , 7.4 W CW, 7.5 Vdc, $I_{DQ} = 100\text{ mA}$, 520 MHz	$R_{\theta JC}$	1.9	°C/W

Table 3. ESD Protection Characteristics

Test Methodology	Class
Human Body Model (per JESD22-A114)	1C, passes 1000 V
Charge Device Model (per JESD22-C101)	C3, passes 2000 V

Table 4. Moisture Sensitivity Level

Test Methodology	Rating	Package Peak Temperature	Unit
Per JESD22-A113, IPC/JEDEC J-STD-020	3	260	°C

Table 5. Electrical Characteristics ($T_A = 25^\circ\text{C}$ unless otherwise noted)

Characteristic	Symbol	Min	Typ	Max	Unit
----------------	--------	-----	-----	-----	------

Off Characteristics

Zero Gate Voltage Drain Leakage Current ($V_{DS} = 30\text{ Vdc}$, $V_{GS} = 0\text{ Vdc}$)	I_{DSS}	—	—	10	μA dc
Zero Gate Voltage Drain Leakage Current ($V_{DS} = 7.5\text{ Vdc}$, $V_{GS} = 0\text{ Vdc}$)	I_{DSS}	—	—	2	μA dc
Gate-Source Leakage Current ($V_{GS} = 5\text{ Vdc}$, $V_{DS} = 0\text{ Vdc}$)	I_{GSS}	—	—	1	nA

On Characteristics

Gate Threshold Voltage ($V_{DS} = 10\text{ Vdc}$, $I_D = 110\ \mu\text{A}$)	$V_{GS(th)}$	1.6	2.1	2.6	Vdc
Drain-Source On-Voltage ($V_{GS} = 10\text{ Vdc}$, $I_D = 1.1\text{ A}$)	$V_{DS(on)}$	—	0.12	—	Vdc
Forward Transconductance ($V_{DS} = 7.5\text{ Vdc}$, $I_D = 3\text{ A}$)	g_{fs}	—	9.8	—	S

Dynamic Characteristics

Reverse Transfer Capacitance ($V_{DS} = 7.5\text{ Vdc} \pm 30\text{ mV(rms)ac}$ @ 1 MHz, $V_{GS} = 0\text{ Vdc}$)	C_{rss}	—	2.4	—	pF
Output Capacitance ($V_{DS} = 7.5\text{ Vdc} \pm 30\text{ mV(rms)ac}$ @ 1 MHz, $V_{GS} = 0\text{ Vdc}$)	C_{oss}	—	55.2	—	pF
Input Capacitance ($V_{DS} = 7.5\text{ Vdc}$, $V_{GS} = 0\text{ Vdc} \pm 30\text{ mV(rms)ac}$ @ 1 MHz)	C_{iss}	—	95.7	—	pF

1. Continuous use at maximum temperature will affect MTTF.
 2. MTTF calculator available at <http://www.nxp.com/RF/calculators>.
 3. Refer to AN1955, *Thermal Measurement Methodology of RF Power Amplifiers*. Go to <http://www.nxp.com/RF> and search for AN1955.
- (continued)

Table 5. Electrical Characteristics ($T_A = 25^\circ\text{C}$ unless otherwise noted) **(continued)**

Characteristic	Symbol	Min	Typ	Max	Unit
Narrowband Performance – 520 MHz (In NXP Narrowband 520 MHz RF Test Fixture, 50 ohm system) $V_{DD} = 7.5\text{ Vdc}$, $I_{DQ} = 100\text{ mA}$, $P_{in} = 18.5\text{ dBm}$, $f = 520\text{ MHz}$					
Common-Source Amplifier Output Power	P_{out}	—	8.4	—	W
Drain Efficiency	η_D	—	73.9	—	%

Load Mismatch/Ruggedness (In NXP Narrowband 520 MHz RF Test Fixture, 50 ohm system) $I_{DQ} = 100\text{ mA}$

Frequency (MHz)	Signal Type	VSWR	P_{in} (dBm)	Test Voltage, V_{DD}	Result
520	CW	> 65:1 at all Phase Angles	21 (3 dB Overdrive)	10.8	No Device Degradation

Table 6. Ordering Information

Device	Tape and Reel Information	Package
AFM907NT1	T1 Suffix = 1,000 Units, 16 mm Tape Width, 7-inch Reel	DFN 4 × 6

TYPICAL CHARACTERISTICS

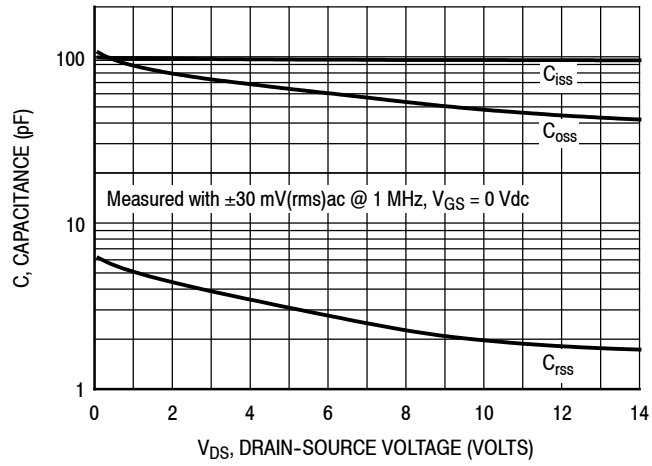
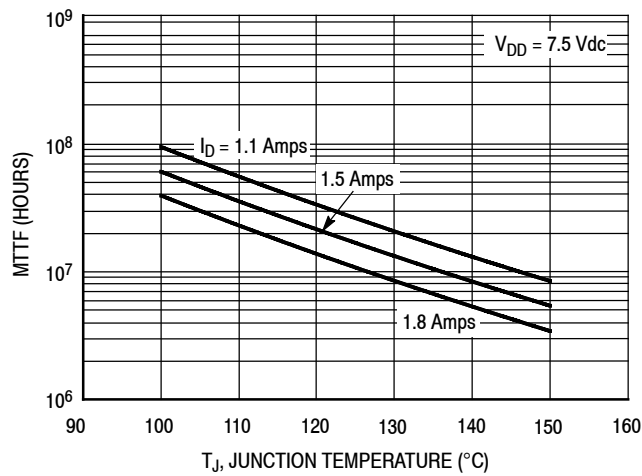

Figure 2. Capacitance versus Drain-Source Voltage



Note: MTTF value represents the total cumulative operating time under indicated test conditions.

MTTF calculator available at <http://www.nxp.com/RF/calculators>.

Figure 3. MTTF versus Junction Temperature – CW

350–520 MHz UHF BROADBAND REFERENCE CIRCUIT

Table 7. 350–520 MHz UHF Broadband Performance (In NXP UHF Broadband Reference Circuit, 50 ohm system) $V_{DD} = 7.5$ Vdc, $I_{DQ} = 200$ mA, $T_A = 25^\circ\text{C}$, CW

Frequency (MHz)	P_{in} (W)	G_{ps} (dB)	η_D (%)	P_{out} (W)
350	0.25	15.2	56.6	8.4
435	0.25	15.5	61.5	8.9
520	0.25	15.0	64.2	7.9

350-520 MHz UHF BROADBAND REFERENCE CIRCUIT — 0.83" × 1.88" (21.1 mm × 47.8 mm)

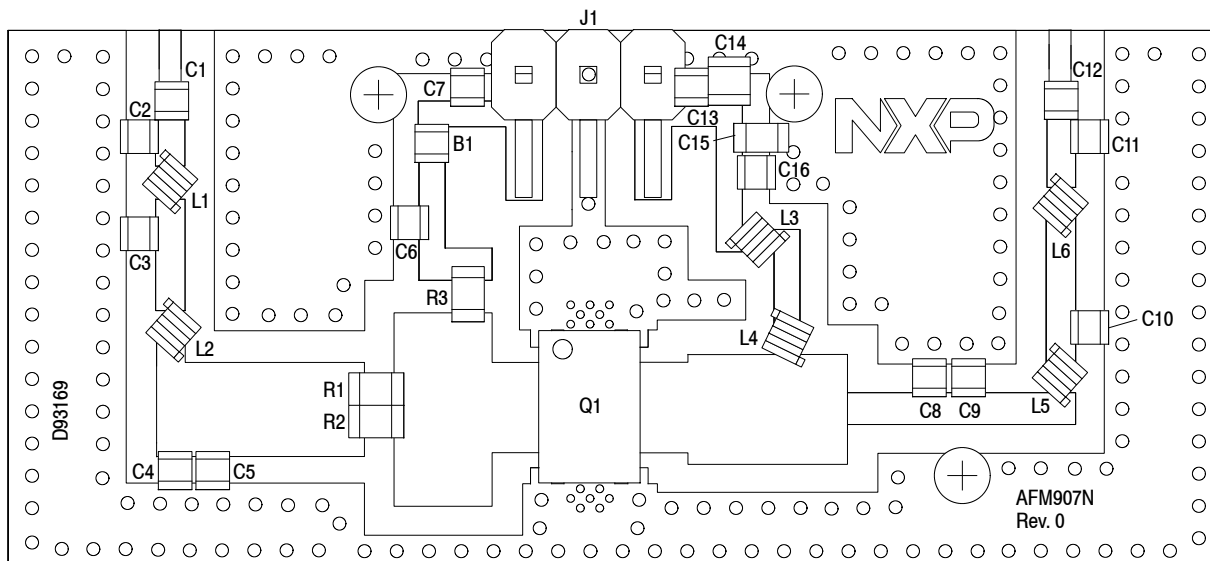

Figure 4. AFM907N UHF Broadband Reference Circuit Component Layout — 350-520 MHz

Table 8. AFM907N UHF Broadband Reference Circuit Component Designations and Values — 350-520 MHz

Part	Description	Part Number	Manufacturer
B1	30 Ω, 6 A Ferrite Bead	MPZ2012S300AT000	TDK
C1, C12	100 pF Chip Capacitor	ATC600F101JT250XT	ATC
C2	8.2 pF Chip Capacitor	ATC600F8R2BT250XT	ATC
C3, C5	36 pF Chip Capacitor	ATC600F360JT250XT	ATC
C4, C8, C9	27 pF Chip Capacitor	ATC600F270JT250XT	ATC
C6	1 μF Chip Capacitor	GRM21BR71H105KA12L	Murata
C7	0.01 μF Chip Capacitor	C0805C103K5RAC	Kemet
C10	18 pF Chip Capacitor	ATC600F180JT250XT	ATC
C11	9.1 pF Chip Capacitor	ATC600F9R1BT250XT	ATC
C13	240 pF Chip Capacitor	ATC600F241JT250XT	ATC
C14	2.2 μF Chip Capacitor	GRM31CR71H225KA88L	Murata
C15	4.7 μF 50 V Chip Capacitor	GRM31CR71H475KA12L	Murata
C16	0.01 μF Chip Capacitor	GRM21BR72A103KA01B	Murata
J1	Right-Angle Breakaway Header (3 Pins)	22-28-8360	Molex
L1, L6	8.9 nH Inductor	0806SQ8N9	Coilcraft
L2	1.65 nH Inductor, 2 Turns	0906-2JLC	Coilcraft
L3, L4	17 nH Inductor	0908SQ17N	Coilcraft
L5	2.55 nH Inductor, 3 Turns	0906-3JLC	Coilcraft
Q1	RF Power LDMOS Transistor	AFM907N	NXP
R1, R2	1.5 Ω, 1/4 W Chip Resistor	RC1206FR-071R5L	Yageo
R3	51 Ω, 1/4 W Chip Resistor	CRCW120651R0FKEA	Vishay
PCB	Shengyi S1000-2, 0.020", ε _r = 4.8	D93169	MTL

TYPICAL CHARACTERISTICS — 350–520 MHz UHF BROADBAND REFERENCE CIRCUIT

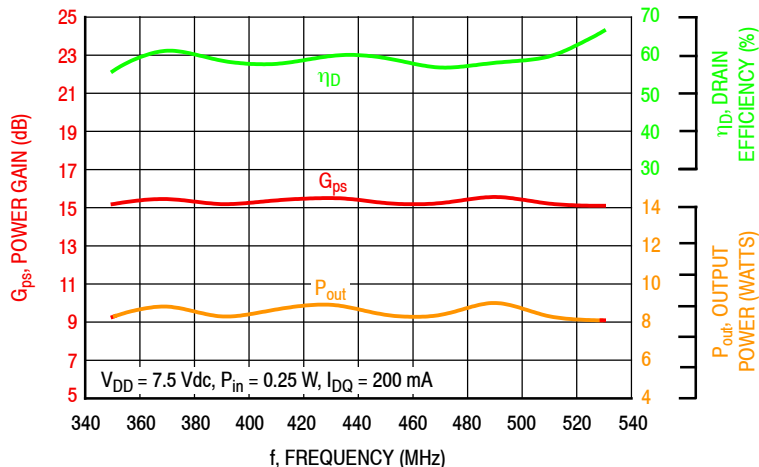

Figure 5. Power Gain, Drain Efficiency and Output Power versus Frequency at a Constant Input Power

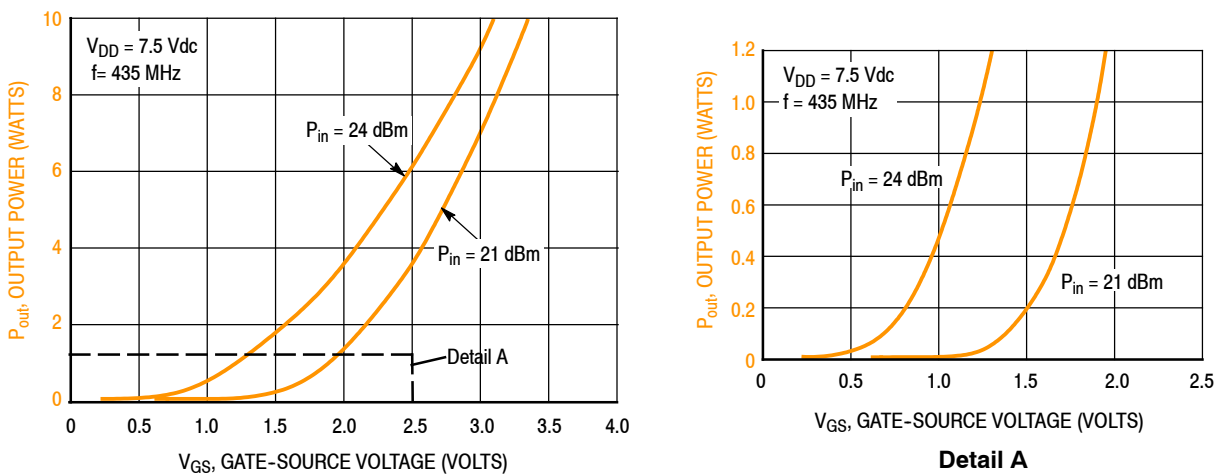

Figure 6. Output Power versus Gate-Source Voltage

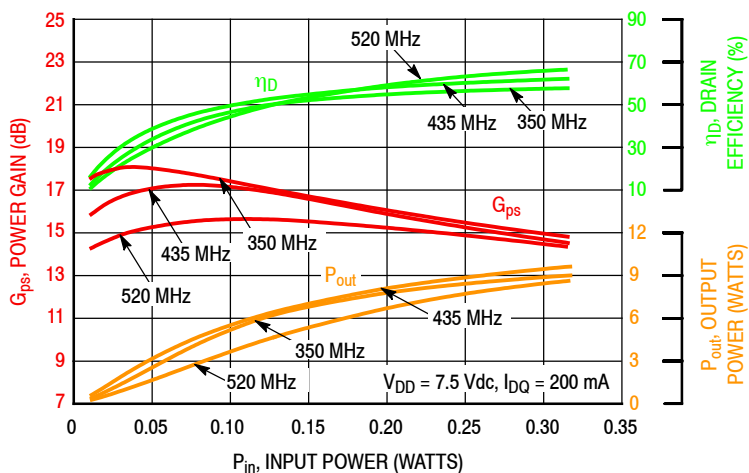
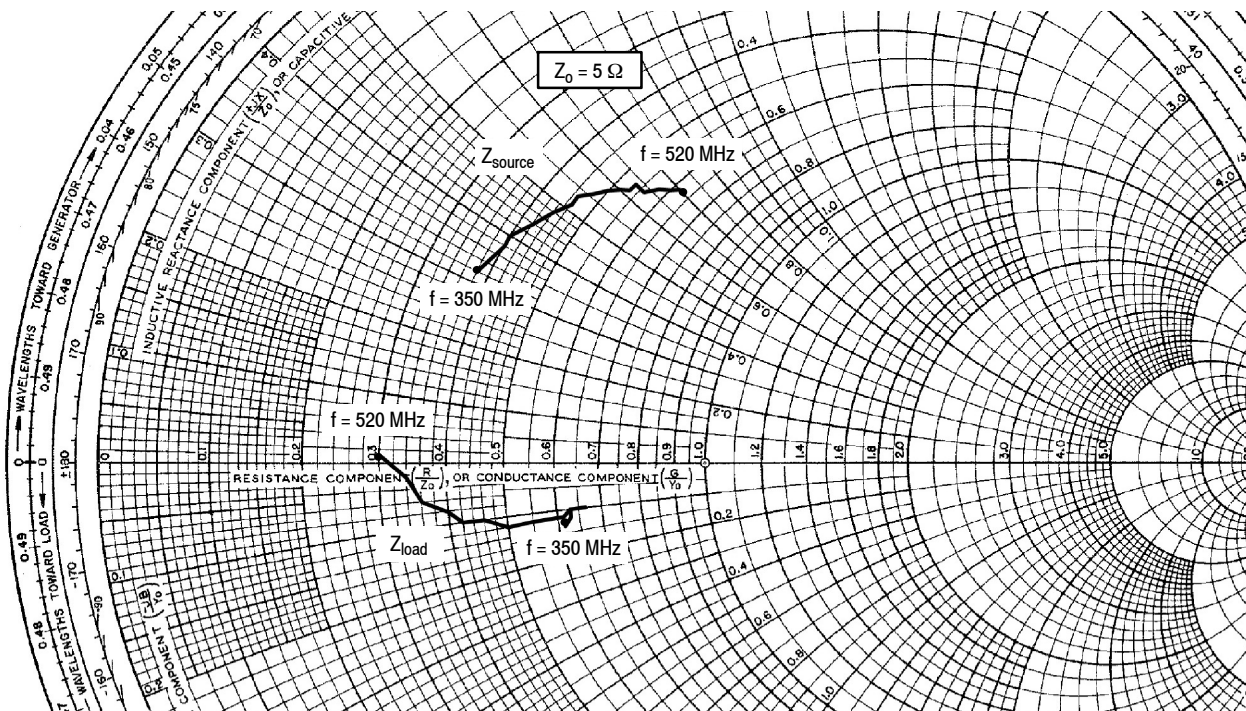

Figure 7. Power Gain, Drain Efficiency and Output Power versus Input Power and Frequency

350–520 MHz BROADBAND REFERENCE CIRCUIT



f MHz	Z _{source} Ω	Z _{load} Ω
350	1.9 + j1.6	3.1 - j0.7
360	2.0 + j1.9	3.2 - j0.6
370	2.0 + j2.0	3.2 - j0.5
380	2.1 + j2.2	3.3 - j0.5
390	2.2 + j2.4	3.3 - j0.5
400	2.3 + j2.6	3.2 - j0.5
410	2.3 + j2.7	3.2 - j0.5
420	2.4 + j2.8	3.1 - j0.6
430	2.5 + j2.9	3.0 - j0.6
440	2.6 + j3.0	2.8 - j0.6
450	2.7 + j3.1	2.7 - j0.6
460	2.7 + j3.2	2.5 - j0.6
470	2.8 + j3.2	2.3 - j0.5
480	2.9 + j3.3	2.1 - j0.5
490	3.0 + j3.4	2.0 - j0.4
500	3.0 + j3.4	1.8 - j0.3
510	3.1 + j3.5	1.7 - j0.1
520	3.2 + j3.5	1.5 + j0.04

Z_{source} = Test circuit impedance as measured from gate to ground.

Z_{load} = Test circuit impedance as measured from drain to ground.

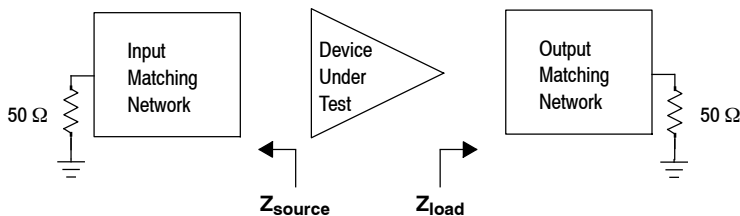

Figure 8. Broadband Series Equivalent Source and Load Impedance — 350–520 MHz

520 MHz NARROWBAND RF TEST FIXTURE — 5.0" × 3.0" (12.70 cm × 7.62 cm)

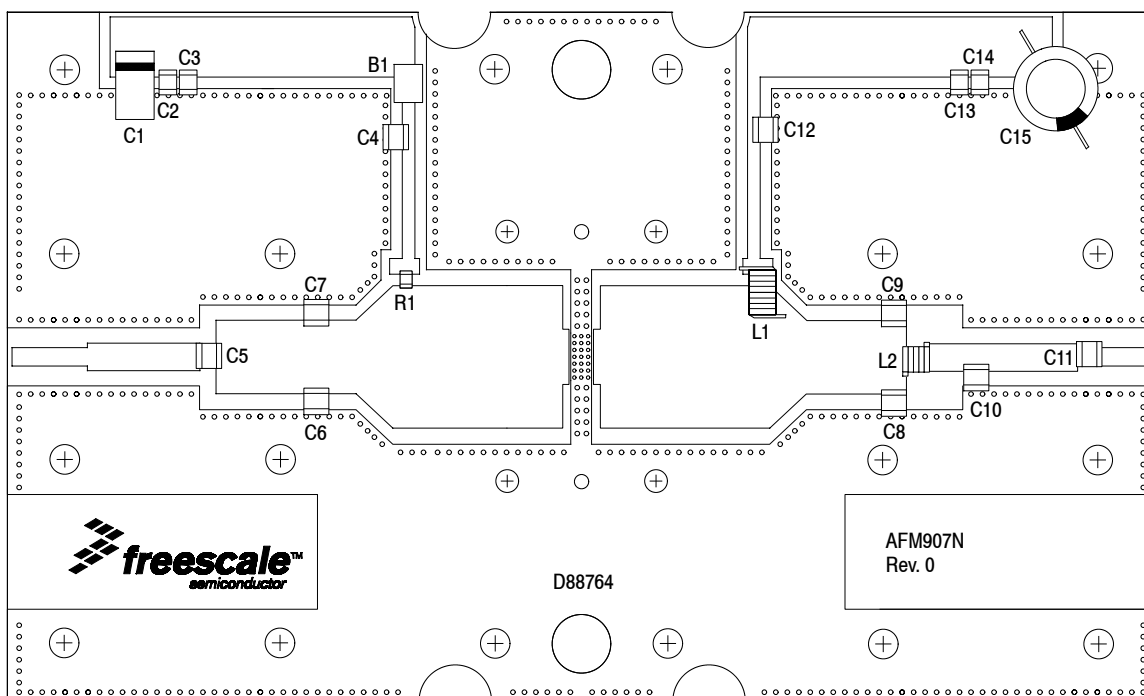

Figure 9. AFM907N Narrowband RF Test Fixture Component Layout — 520 MHz

Table 9. AFM907N Narrowband RF Test Fixture Component Designations and Values — 520 MHz

Part	Description	Part Number	Manufacturer
B1	Short RF Bead	2743019447	Fair-Rite
C1	22 μ F, 35 V Tantalum Capacitor	T491X226K035AT	Kemet
C2, C14	0.1 μ F Chip Capacitor	CDR33BX104AKWS	AVX
C3, C13	0.01 μ F Chip Capacitor	C0805C103K5RAC	Kemet
C4, C12	180 pF Chip Capacitor	ATC100B181JT300XT	ATC
C5	33 pF Chip Capacitor	ATC100B130JT500XT	ATC
C6	20 pF Chip Capacitor	ATC100B200JT500XT	ATC
C7	22 pF Chip Capacitor	ATC100B220JT500XT	ATC
C8, C9	16 pF Chip Capacitor	ATC100B160JT500XT	ATC
C10	2.7 pF Chip Capacitor	ATC100B2R7BT500XT	ATC
C11	30 pF Chip Capacitor	ATC100B300JT500XT	ATC
C15	330 μ F, 35 V Electrolytic Capacitor	MCGPR35V337M10X16-RH	Multicomp
L1	22 nH Inductor, 7 Turns	B07TJLC	Coilcraft
L2	5 nH Inductor, 2 Turns	A02TKLC	Coilcraft
R1	5.6 Ω , 1/4 W Chip Resistor	CRCW12065R60FKEA	Vishay
PCB	Rogers RO4350B, 0.030", $\epsilon_r = 3.66$	D88764	MTL

TYPICAL CHARACTERISTICS — 520 MHz NARROWBAND RF TEST FIXTURE

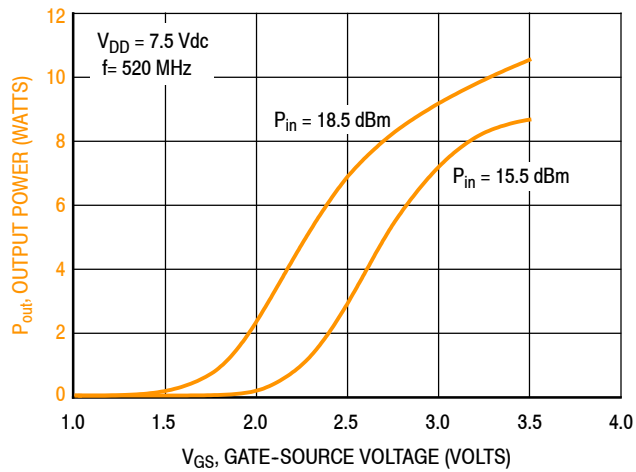

Figure 10. Output Power versus Gate-Source Voltage

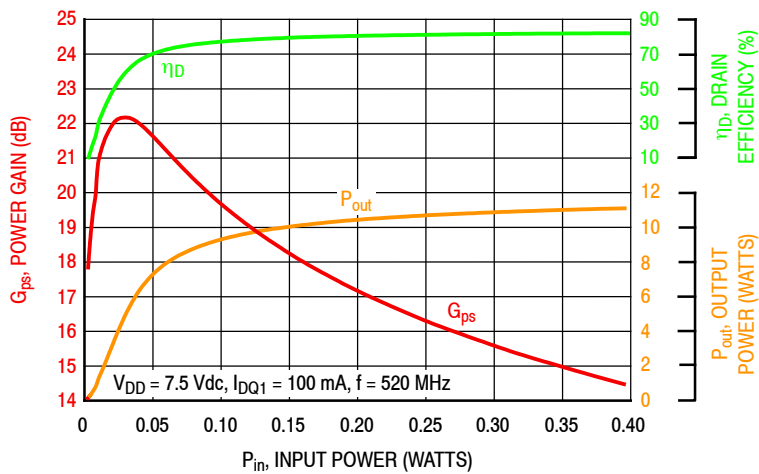

Figure 11. Power Gain, Drain Efficiency and Output Power versus Input Power

520 MHz PRODUCTION TEST FIXTURE

f MHz	Z _{source} Ω	Z _{load} Ω
520	0.71 + j1.98	1.73 + j1.64

Z_{source} = Test circuit impedance as measured from gate to ground.

Z_{load} = Test circuit impedance as measured from drain to ground.

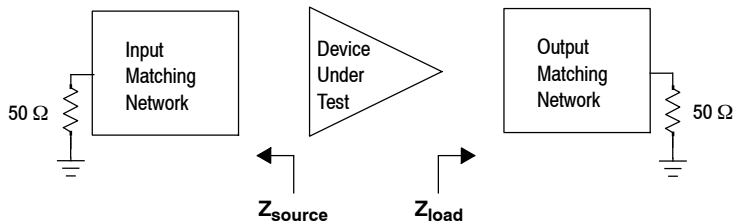

Figure 12. Series Equivalent Source and Load Impedance — 520 MHz

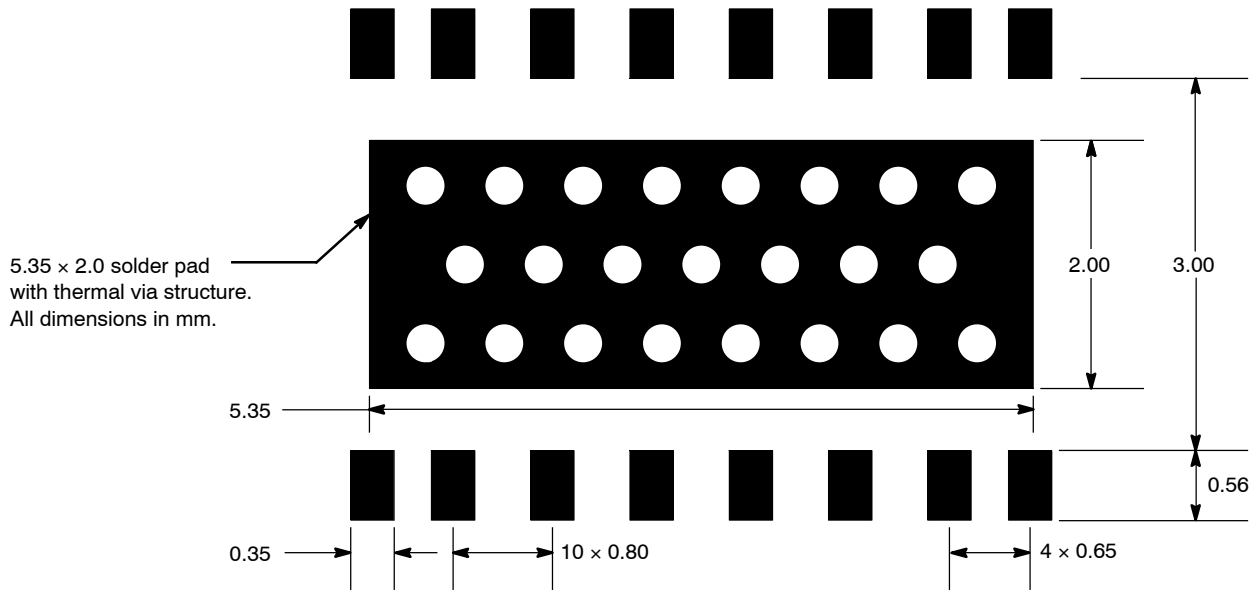
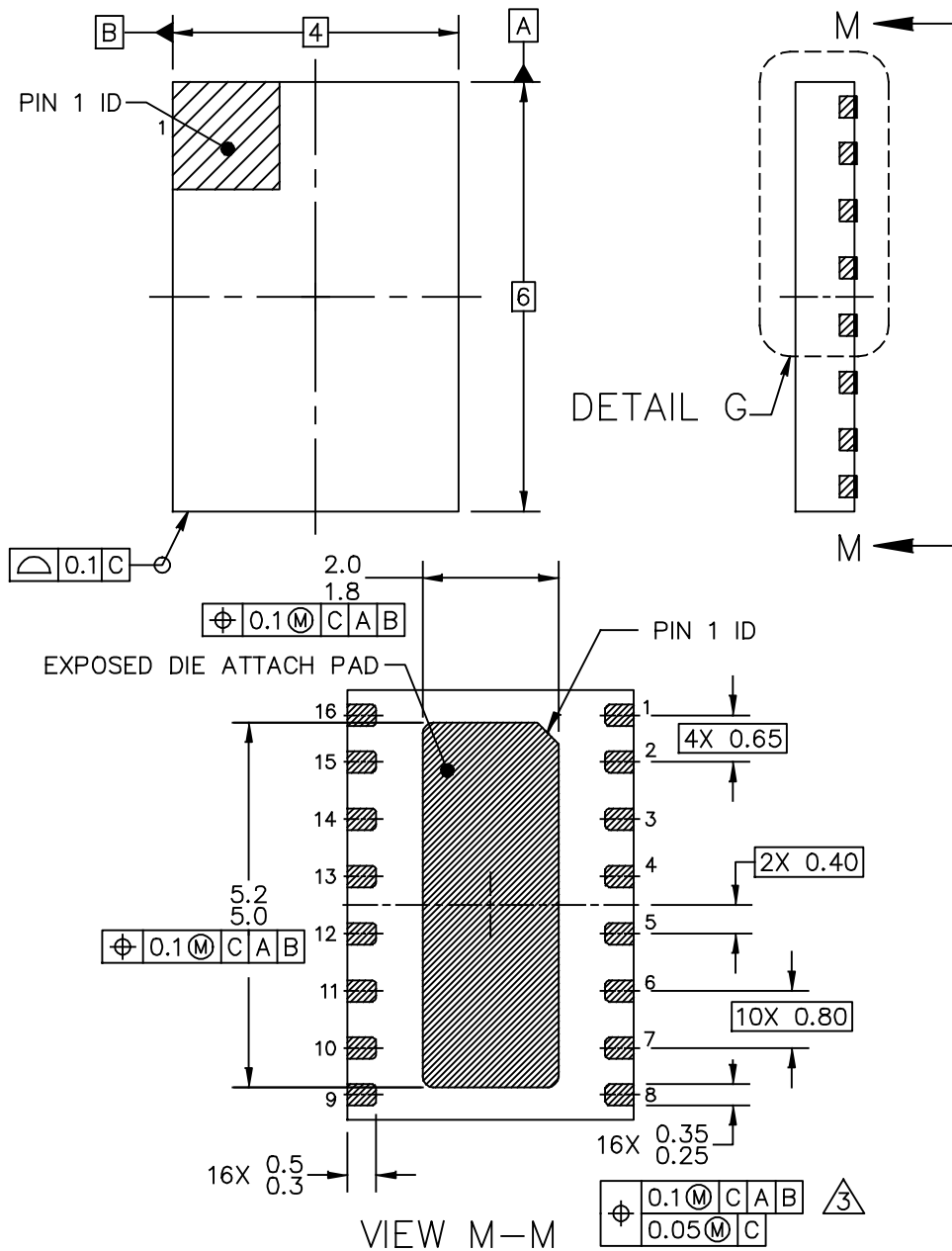

Figure 13. PCB Pad Layout for 16-Lead DFN 4 × 6

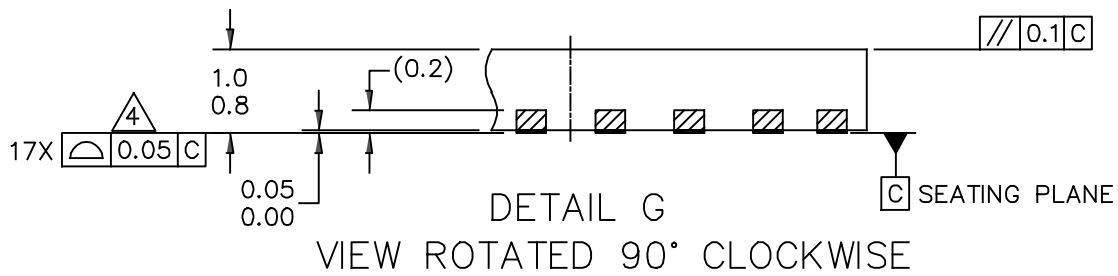

Figure 14. Product Marking

PACKAGE DIMENSIONS



© NXP SEMICONDUCTORS N.V. ALL RIGHTS RESERVED	MECHANICAL OUTLINE	PRINT VERSION NOT TO SCALE
TITLE: DFN, THERMALLY ENHANCED 4 X 6 X 0.9, 0.8 & 0.65 PITCH, 16 TERMINAL	DOCUMENT NO: 98ASA00868D REV: B	
	STANDARD: NON-JEDEC	
	SOT1862-1	27 JUL 2016



© NXP SEMICONDUCTORS N.V. ALL RIGHTS RESERVED	MECHANICAL OUTLINE	PRINT VERSION NOT TO SCALE
TITLE: DFN, THERMALLY ENHANCED 4 X 6 X 0.9, 0.8 & 0.65 PITCH, 16 TERMINAL	DOCUMENT NO: 98ASA00868D	REV: B
	STANDARD: NON-JEDEC	
	SOT1862-1	27 JUL 2016

NOTES:

1. DIMENSIONING & TOLERANCING CONFIRM TO ASME Y14.5M–1994.

2. ALL DIMENSIONS ARE IN MILLIMETERS. ANGLES ARE IN DEGREES.

3. THIS DIMENSION APPLIES TO METALLIZED TERMINAL AND IS MEASURED BETWEEN 0.25 MM AND 0.30 MM FROM TERMINAL TIP.

4. COPLANARITY APPLIES TO THE EXPOSED HEAT SLUG AS WELL AS THE TERMINALS.

© NXP SEMICONDUCTORS N.V. ALL RIGHTS RESERVED	MECHANICAL OUTLINE	PRINT VERSION NOT TO SCALE	
TITLE: DFN, THERMALLY ENHANCED 4 X 6 X 0.9, 0.8 & 0.65 PITCH, 16 TERMINAL		DOCUMENT NO: 98ASA00868D	REV: B
		STANDARD: NON-JEDEC	
		SOT1862-1	27 JUL 2016

PRODUCT DOCUMENTATION, SOFTWARE AND TOOLS

Refer to the following resources to aid your design process.

Application Notes

- AN1907: Solder Reflow Attach Method for High Power RF Devices in Over-Molded Plastic Packages
- AN1955: Thermal Measurement Methodology of RF Power Amplifiers

Engineering Bulletins

- EB212: Using Data Sheet Impedances for RF LDMOS Devices

Software

- Electromigration MTTF Calculator
- RF High Power Model
- .s2p File

Development Tools

- Printed Circuit Boards

To Download Resources Specific to a Given Part Number:

1. Go to <http://www.nxp.com/RF>
2. Search by part number
3. Click part number link
4. Choose the desired resource from the drop down menu

REVISION HISTORY

The following table summarizes revisions to this document.

Revision	Date	Description
0	Apr. 2017	<ul style="list-style-type: none">• Initial release of data sheet
1	May 2019	<ul style="list-style-type: none">• Table 1, Max Ratings table, Operating Voltage: changed 7.5 Vdc to 12.5 Vdc to reflect additional qualification data, p. 2• Table 9, Narrowband RF Test Fixture Component Designations and Values — 520 MHz: corrected C6 to 20 pF ATC100B200JT500XT and C7 to 22 pF, p. 9• Fig. 12, Series Equivalent Source and Load Impedance — 520 MHz: added to data sheet, p. 11

How to Reach Us:

Home Page:
nxp.com

Web Support:
nxp.com/support

Information in this document is provided solely to enable system and software implementers to use NXP products. There are no express or implied copyright licenses granted hereunder to design or fabricate any integrated circuits based on the information in this document. NXP reserves the right to make changes without further notice to any products herein.

NXP makes no warranty, representation, or guarantee regarding the suitability of its products for any particular purpose, nor does NXP assume any liability arising out of the application or use of any product or circuit, and specifically disclaims any and all liability, including without limitation consequential or incidental damages. "Typical" parameters that may be provided in NXP data sheets and/or specifications can and do vary in different applications, and actual performance may vary over time. All operating parameters, including "typicals," must be validated for each customer application by customer's technical experts. NXP does not convey any license under its patent rights nor the rights of others. NXP sells products pursuant to standard terms and conditions of sale, which can be found at the following address: nxp.com/SalesTermsandConditions.

NXP, the NXP logo, Freescale, the Freescale logo, and Airfast are trademarks of NXP B.V. All other product or service names are the property of their respective owners.
© 2017, 2019 NXP B.V.

X-ON Electronics

Largest Supplier of Electrical and Electronic Components

Click to view similar products for [RF MOSFET Transistors](#) category:

Click to view products by [NXP](#) manufacturer:

Other Similar products are found below :

[MRF492](#) [MRFE8VP8600HR5](#) [ARF1511](#) [ARF465BG](#) [BF 2030 E6814](#) [BLF861A](#) [DU1215S](#) [DU28200M](#) [UF28100M](#) [DU2820S](#)
[MHT1008NT1](#) [MMRF1014NT1](#) [MRF426](#) [ARF468AG](#) [ARF468BG](#) [MAPHST0045](#) [DU2860U](#) [MRFE6VP5300NR1](#) [BF2040E6814HTSA1](#)
[MRFE6VP5150GMR1](#) [LET9060S](#) [MRF136Y](#) [BF999E6327HTSA1](#) [SD2931-12MR](#) [BF998E6327HTSA1](#) [MRF141](#) [MRF171](#) [MRF172](#)
[MRF174](#) [SD2942](#) [QPD1020SR](#) [BF 1005S E6327](#) [MRF134](#) [MRF136](#) [MRF137](#) [MRF141G](#) [MRF151A](#) [MRF151G](#) [MRF157](#) [MRF158](#)
[MRF160](#) [MRF166C](#) [MRF171A](#) [MRF177](#) [UF2840G](#) [TGF3021-SM](#) [ARF1510](#) [ARF448BG](#) [ARF449AG](#) [ARF466BG](#)