

# BGA6489

MMIC wideband medium power amplifier

Rev. 02 — 15 June 2009

Product data sheet

## 1. Product profile

### 1.1 General description

The BGA6489 is a silicon Monolithic Microwave Integrated Circuit (MMIC) wideband medium power amplifier with internal matching circuit in a 3-pin SOT89 plastic, low thermal resistance, SMD package.

The BGA6x89 series of medium power gain blocks are resistive feedback Darlington configured amplifiers. Resistive feedback provides large bandwidth with high accuracy.

#### CAUTION



This device is sensitive to ElectroStatic Discharge (ESD). Therefore care should be taken during transport and handling.

### 1.2 Features

- Broadband 50  $\Omega$  gain block
- 20 dBm output power
- SOT89 package
- Single supply voltage needed

### 1.3 Applications

- Broadband medium power gain blocks
- Small signal high linearity amplifiers
- Variable gain and high output power in combination with the BGA2031
- Cellular, PCS and CDPD
- IF/RF buffer amplifier
- Wireless data SONET
- Oscillator amplifier, final PA
- Drivers for CATV amplifier

**1.4 Quick reference data**

**Table 1. Quick reference data**

Symbol	Parameter	Conditions	Min	Typ	Max	Unit
$V_D$	DC device voltage	on pin 1; $I_S = 78 \text{ mA}$	-	5.1	-	V
$I_S$	DC supply current	$V_S = 8 \text{ V}$ ; $R_1 = 39 \text{ }\Omega$ ; $T_j = 25 \text{ }^\circ\text{C}$	-	78	-	mA
$ S_{21} ^2$	insertion power gain	$f = 1950 \text{ MHz}$	-	16	-	dB
NF	noise figure	$f = 1950 \text{ MHz}$	-	3.3	-	dB
$P_{L1dB}$	load power at 1 dB gain compression	$f = 850 \text{ MHz}$	-	20	-	dBm
		$f = 1950 \text{ MHz}$	-	17	-	dBm

**2. Pinning information**

**Table 2. Pinning**

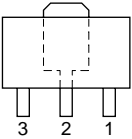
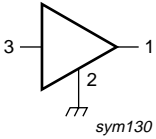
Pin	Description	Simplified outline	Graphic symbol
1	RF_OUT/BIAS		 sym130
2	GND		
3	RF_IN		

**3. Ordering information**

**Table 3. Ordering information**

Type number	Package		Version
	Name	Description	
BGA6489	SC-62	plastic surface-mounted package; collector pad for good heat transfer; 3 leads	SOT89

**4. Marking**

**Table 4. Marking codes**

Type number	Marking code
BGA6489	4A

## 5. Limiting values

**Table 5. Limiting values**

In accordance with the Absolute Maximum Rating System (IEC 60134).

Symbol	Parameter	Conditions	Min	Max	Unit
$V_D$	DC device voltage	on pin 1; RF input AC coupled	-	6	V
$I_S$	DC supply current		-	150	mA
$P_{tot}$	total power dissipation	$T_{sp} \leq 70\text{ °C}$	[1]	800	mW
$T_{stg}$	storage temperature		-65	+150	°C
$T_j$	junction temperature		-	150	°C
$P_D$	maximum drive power		-	15	dBm

[1]  $T_{sp}$  is the temperature at the solder point of the ground lead, pin 2.

## 6. Thermal characteristics

**Table 6. Thermal characteristics**

Symbol	Parameter	Conditions	Typ	Unit	
$R_{th(j-sp)}$	thermal resistance from junction to solder point	$T_{sp} \leq 70\text{ °C}$	[1]	100	K/W

[1]  $T_{sp}$  is the temperature at the solder point of the ground lead, pin 2.

## 7. Characteristics

**Table 7. Static characteristics**

$V_S = 8\text{ V}$ ;  $T_j = 25\text{ °C}$ ;  $R_{bias} = 39\text{ }\Omega$  [1]

Symbol	Parameter	Conditions	Min	Typ	Max	Unit
$V_D$	DC device voltage	on pin 1; $I_S = 78\text{ mA}$	-	5.1	-	V
$I_S$	supply current		70	78	86	mA

[1]  $V_S$  = DC operating supply voltage applied to  $R_{bias}$ ; see [Figure 10](#)

**Table 8. Characteristics**

$V_S = 8\text{ V}$ ;  $I_S = 78\text{ mA}$ ;  $T_{amb} = 25\text{ °C}$ ;  $IP3_{(out)}$  tone spacing = 1 MHz;  $P_L = 0\text{ dB}$  per tone,  $R_{bias} = 39\text{ }\Omega$ ;  $Z_L = Z_S = 50\text{ }\Omega$ ; unless otherwise specified; see [Figure 10](#).

Symbol	Parameter	Conditions	Min	Typ	Max	Unit
$ S_{21} ^2$	Insertion power gain	f = 850 MHz	-	20	-	dB
		f = 1950 MHz	-	16	-	dB
		f = 2500 MHz	-	15	-	dB
$R_{LIN}$	return losses input	f = 850 MHz	-	14	-	dB
		f = 1950 MHz	-	16	-	dB
		f = 2500 MHz	-	19	-	dB
$R_{LOUT}$	return losses output	f = 850 MHz	-	16	-	dB
		f = 1950 MHz	-	12	-	dB
		f = 2500 MHz	-	10	-	dB

**Table 8. Characteristics ...continued**

$V_S = 8\text{ V}$ ;  $I_S = 78\text{ mA}$ ;  $T_{amb} = 25\text{ }^\circ\text{C}$ ;  $IP3_{(out)}$  tone spacing = 1 MHz;  $P_L = 0\text{ dB per tone}$ ,  $R_{bias} = 39\text{ }\Omega$ ;  $Z_L = Z_S = 50\text{ }\Omega$ ; unless otherwise specified; see [Figure 10](#).

Symbol	Parameter	Conditions	Min	Typ	Max	Unit
NF	noise figure	f = 850 MHz	-	3.1	-	dB
		f = 1950 MHz	-	3.3	-	dB
		f = 2500 MHz	-	3.4	-	dB
K	stability factor	f = 850 MHz	-	1.2	-	
		f = 2500 MHz	-	1.3	-	
$P_{L1dB}$	load power at 1 dB gain compression	f = 850 MHz	-	20	-	dBm
		f = 1950 MHz	-	17	-	dBm
$IP3_{(in)}$	input intercept point	f = 850 MHz	-	13	-	dBm
		f = 2500 MHz	-	12	-	dBm
$IP3_{(out)}$	output intercept point	f = 850 MHz	-	33	-	dBm
		f = 2500 MHz	-	27	-	dBm

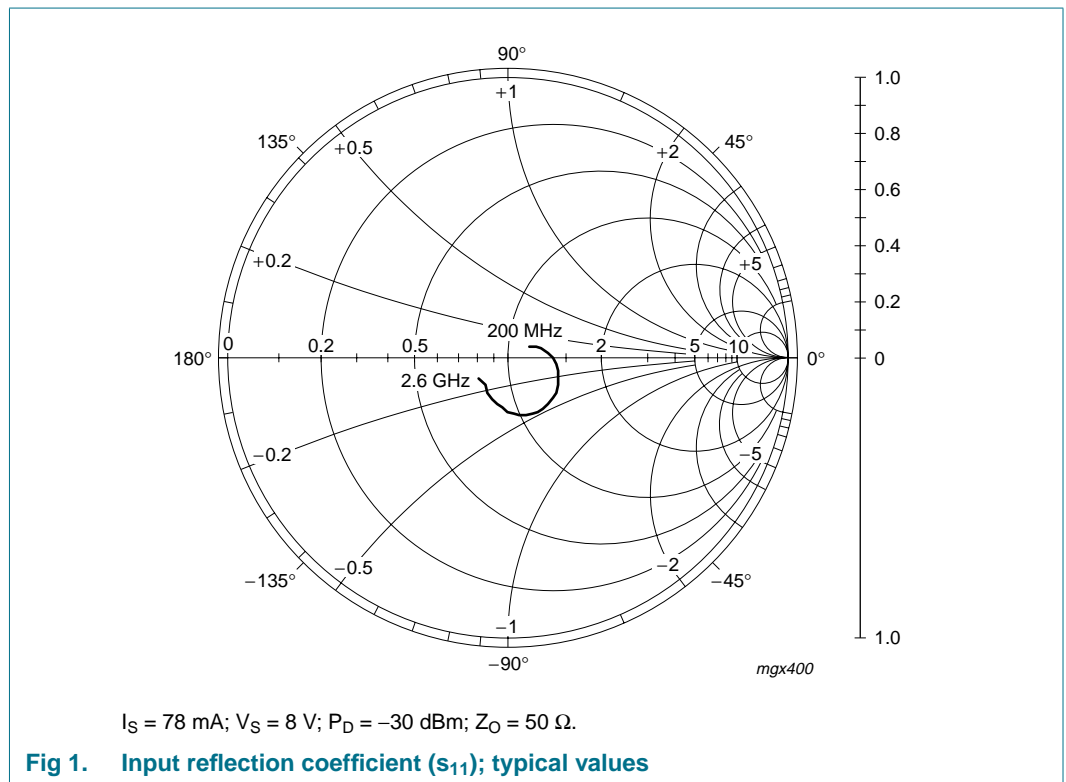

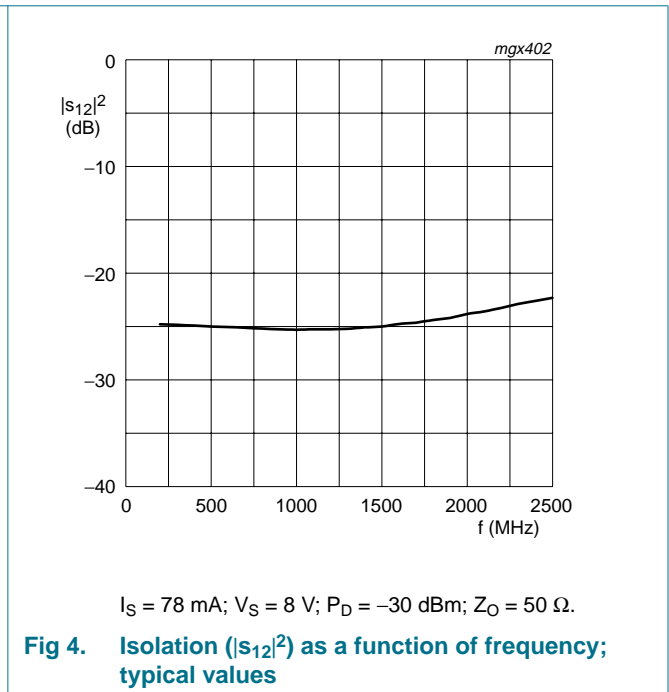
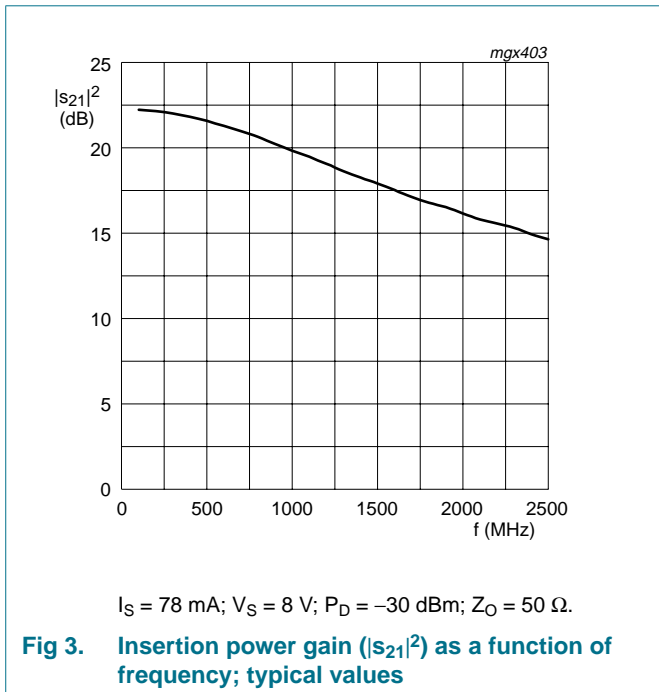
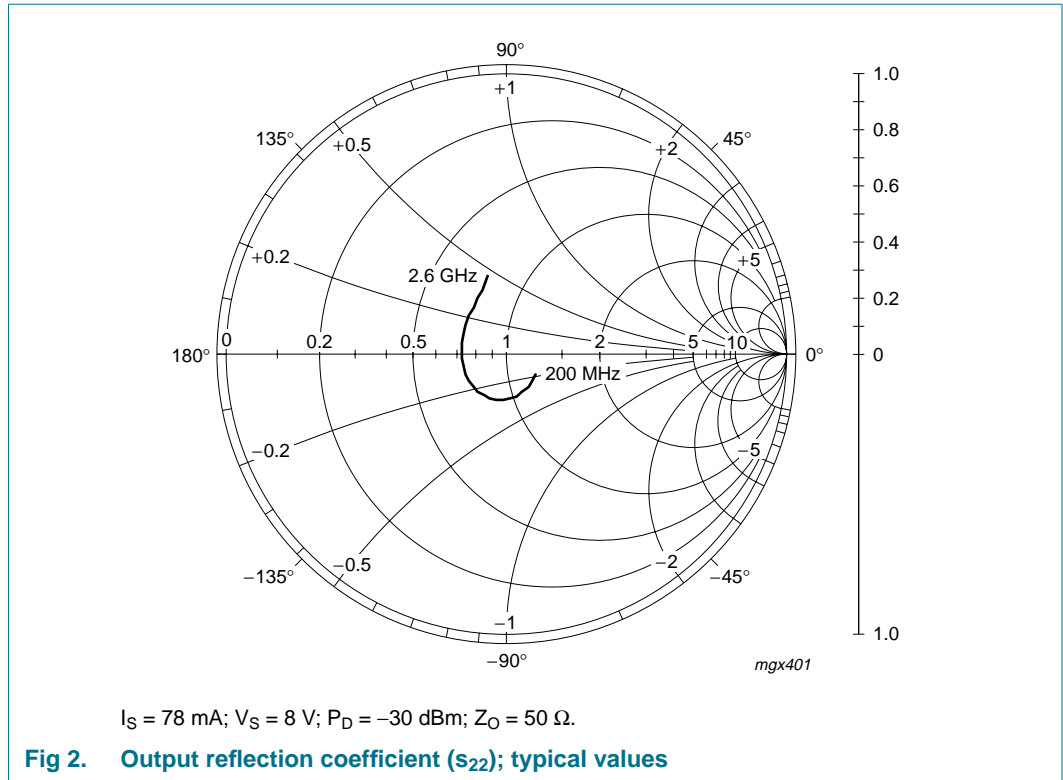

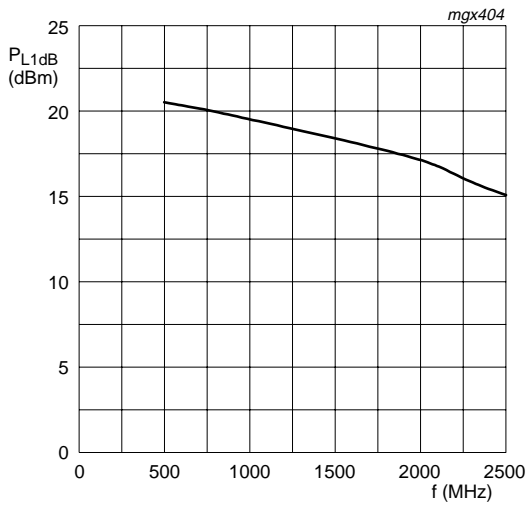

$I_S = 78 \text{ mA}$ ;  $V_S = 8 \text{ V}$ ;  $Z_O = 50 \Omega$ .

**Fig 5. Load power as a function of frequency; typical values**

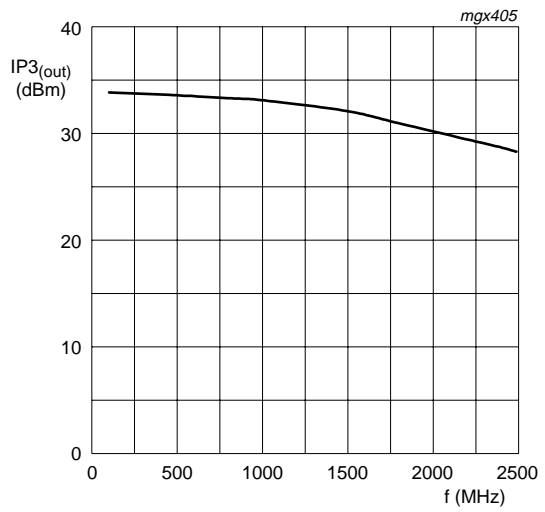

$I_S = 78 \text{ mA}$ ;  $V_S = 8 \text{ V}$ ;  $Z_O = 50 \Omega$ .

**Fig 6. Output intercept as a function of frequency; typical values**

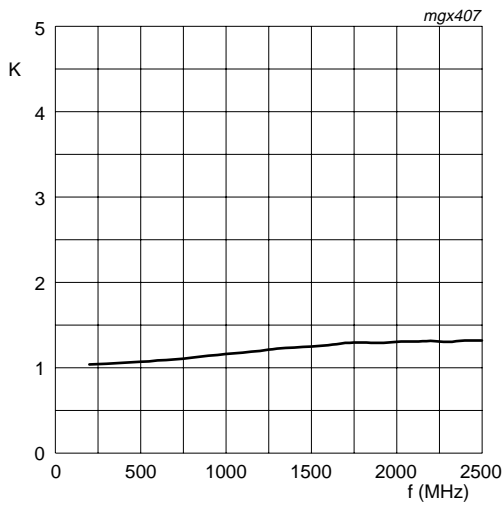

$I_S = 78 \text{ mA}$ ;  $V_S = 8 \text{ V}$ ;  $Z_O = 50 \Omega$ .

**Fig 7. Stability factor as a function of frequency; typical values**

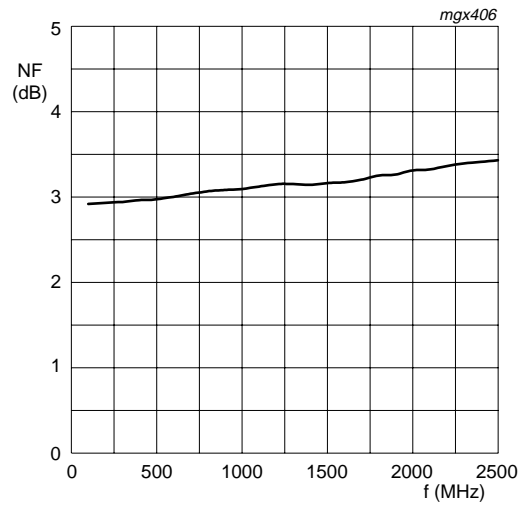

$I_S = 78 \text{ mA}$ ;  $V_S = 8 \text{ V}$ ;  $Z_O = 50 \Omega$ .

**Fig 8. Noise figure as a function of frequency; typical values**

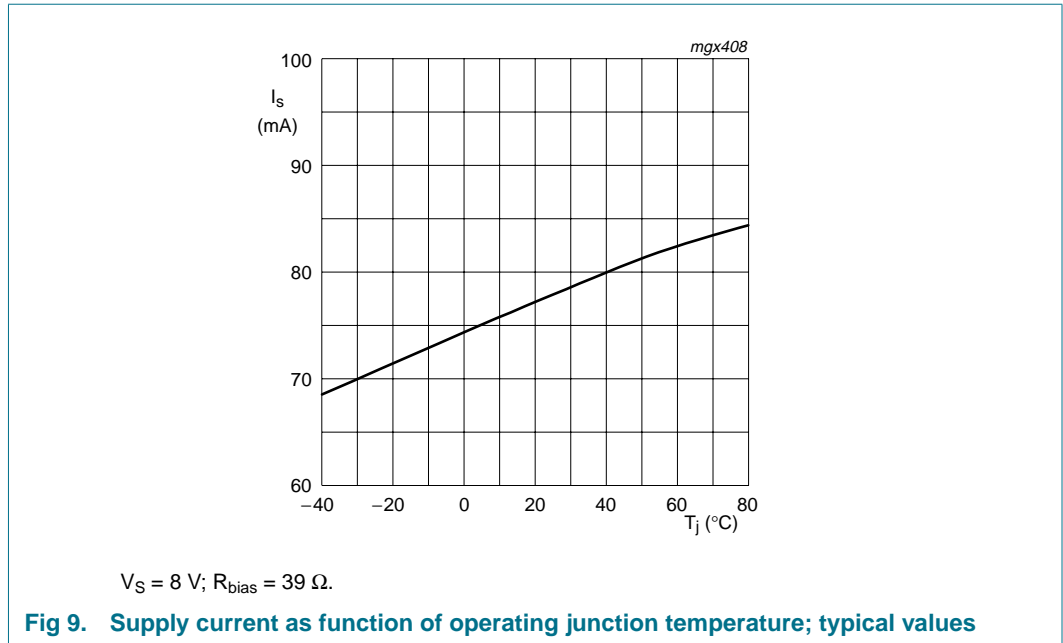

## 8. Application information

Figure 10 shows a typical application circuit for the BGA6489 MMIC. The device is internally matched to 50 Ω and therefore does not require any external matching. The value of the input and output DC blocking capacitors C1 and C2 depends on the operating frequency; see Table 9. Capacitors C1 and C2 are used in conjunction with L1 and C3 to fine tune the input and output impedance. Capacitor C4 is a supply decoupling capacitor. A 1 μF capacitor (C5) can be added for optimum supply decoupling. The external components should be placed as close as possible to the MMIC. When using via holes, use multiple via holes per pin in order to limit ground path induction. Resistor R1 is a bias resistor providing DC current stability with temperature.

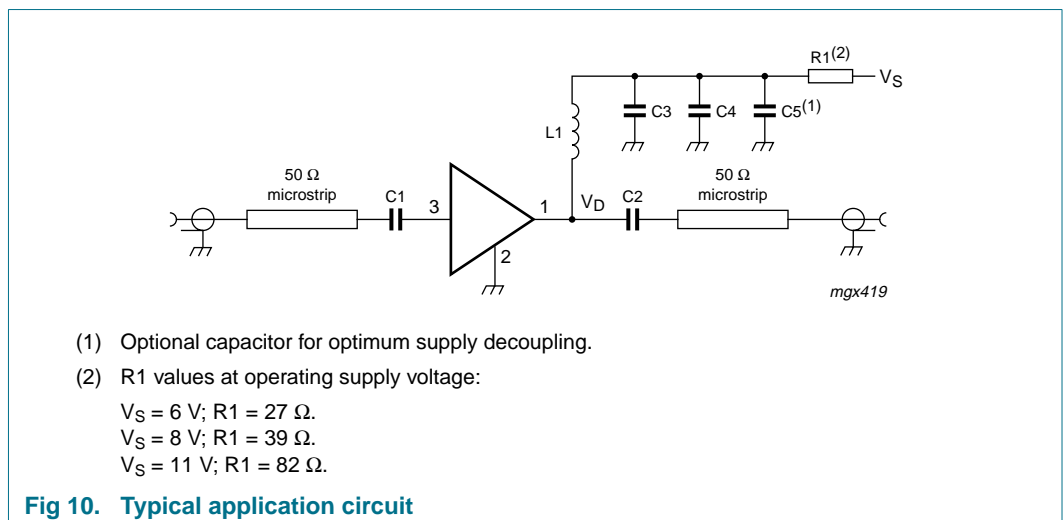

**Table 9. List of components**

See [Figure 10](#) for circuit.

Component	Description	Package	Value at operating frequency				
			500 MHz	800 MHz	1950 MHz	2400 MHz	3500 MHz
C1, C2	multilayer ceramic chip capacitor	0603	220 pF	100 pF	68 pF	56 pF	39 pF
C3	multilayer ceramic chip capacitor	0603	100 pF	68 pF	22 pF	22 pF	15 pF
C4	multilayer ceramic chip capacitor	0603	1 nF	1 nF	1 nF	1 nF	1 nF
C5 <sup>[1]</sup>	electrolytic or tantalum capacitor	0603	1 μF	1 μF	1 μF	1 μF	1 μF
L1	SMD inductor	0603	68 nH	33 nH	22 nH	18 nH	15 nH
R1	SMD resistor 0.5 W; V <sub>S</sub> = 8 V	-	39 Ω	39 Ω	39 Ω	39 Ω	39 Ω

[1] Optional.

## 8.1 Scattering parameters

**Table 10. Scattering parameters**

I<sub>S</sub> = 78 mA; V<sub>S</sub> = 8 V; P<sub>D</sub> = -30 dBm; Z<sub>O</sub> = 50 Ω; T<sub>amb</sub> = 25 °C

f (MHz)	S <sub>11</sub>		S <sub>21</sub>		S <sub>12</sub>		S <sub>22</sub>		K
	Magnitude (ratio)	Angle (degree)	Magnitude (ratio)	Angle (degree)	Magnitude (ratio)	Angle (degree)	Magnitude (ratio)	Angle (degree)	
200	0.06	28.11	12.79	164.42	0.06	-0.30	0.12	-22.91	1.1
300	0.09	27.41	12.59	156.85	0.06	-0.39	0.13	-35.38	1.1
400	0.11	21.64	12.31	149.28	0.06	-0.35	0.14	-46.54	1.1
500	0.12	15.28	11.97	141.88	0.06	-0.32	0.14	-57.20	1.1
600	0.14	8.01	11.57	134.79	0.06	0.04	0.15	-61.41	1.1
700	0.16	0.34	11.18	127.97	0.06	0.63	0.16	-76.76	1.1
800	0.17	-7.27	10.75	121.56	0.05	1.57	0.16	-85.75	1.2
900	0.18	-14.78	10.24	115.06	0.05	1.85	0.17	-94.28	1.2
1000	0.19	-22.18	9.80	109.18	0.05	3.16	0.17	-102.4	1.2
1100	0.20	-29.33	9.40	103.40	0.05	4.29	0.17	-110.3	1.2
1200	0.21	-36.41	8.96	98.12	0.05	5.64	0.17	-118.5	1.2
1300	0.21	-42.47	8.53	92.76	0.05	7.03	0.17	-126.7	1.2
1400	0.22	-49.06	8.16	87.50	0.06	7.74	0.17	-134.8	1.2
1500	0.22	-55.46	7.85	82.76	0.06	9.08	0.17	-143.5	1.3
1600	0.22	-61.20	7.51	78.52	0.06	10.76	0.16	-152.7	1.3
1700	0.22	-67.02	7.16	74.16	0.06	11.89	0.16	-161.8	1.3
1800	0.21	-73.40	6.90	69.37	0.06	12.34	0.16	-171.9	1.3
1900	0.21	-78.99	6.69	65.14	0.06	13.16	0.16	177.4	1.3
2000	0.20	-84.54	6.42	61.15	0.06	14.33	0.16	166.81	1.3
2100	0.19	-91.32	6.16	56.80	0.07	14.84	0.17	156.07	1.3
2200	0.18	-97.58	5.99	52.55	0.07	15.05	0.17	145.29	1.3
2300	0.17	-103.60	5.83	49.08	0.07	15.72	0.19	135.65	1.3
2400	0.16	-111.90	5.58	45.43	0.07	15.96	0.20	126.23	1.3
2500	0.14	-120.80	5.39	40.67	0.08	15.27	0.22	117.16	1.3
2600	0.13	-129.80	5.30	36.66	0.08	14.68	0.24	110.35	1.3



**Table 10. Scattering parameters** $I_S = 78 \text{ mA}$ ;  $V_S = 8 \text{ V}$ ;  $P_D = -30 \text{ dBm}$ ;  $Z_O = 50 \Omega$ ;  $T_{amb} = 25^\circ \text{C}$ 

f (MHz)	S <sub>11</sub>		S <sub>21</sub>		S <sub>12</sub>		S <sub>22</sub>		K
	Magnitude (ratio)	Angle (degree)	Magnitude (ratio)	Angle (degree)	Magnitude (ratio)	Angle (degree)	Magnitude (ratio)	Angle (degree)	
2700	0.13	-143.80	5.18	33.88	0.08	15.64	0.28	104.05	1.3
2800	0.12	-154.47	5.08	30.28	0.08	15.56	0.31	97.10	1.3
2900	0.11	-164.40	4.71	22.43	0.09	11.60	0.28	91.75	1.3
3000	0.11	178.65	4.66	18.90	0.09	11.05	0.31	84.80	1.3
3100	0.12	160.01	4.45	18.63	0.10	10.63	0.33	80.37	1.3

9. Package outline

Plastic surface-mounted package; collector pad for good heat transfer; 3 leads

SOT89

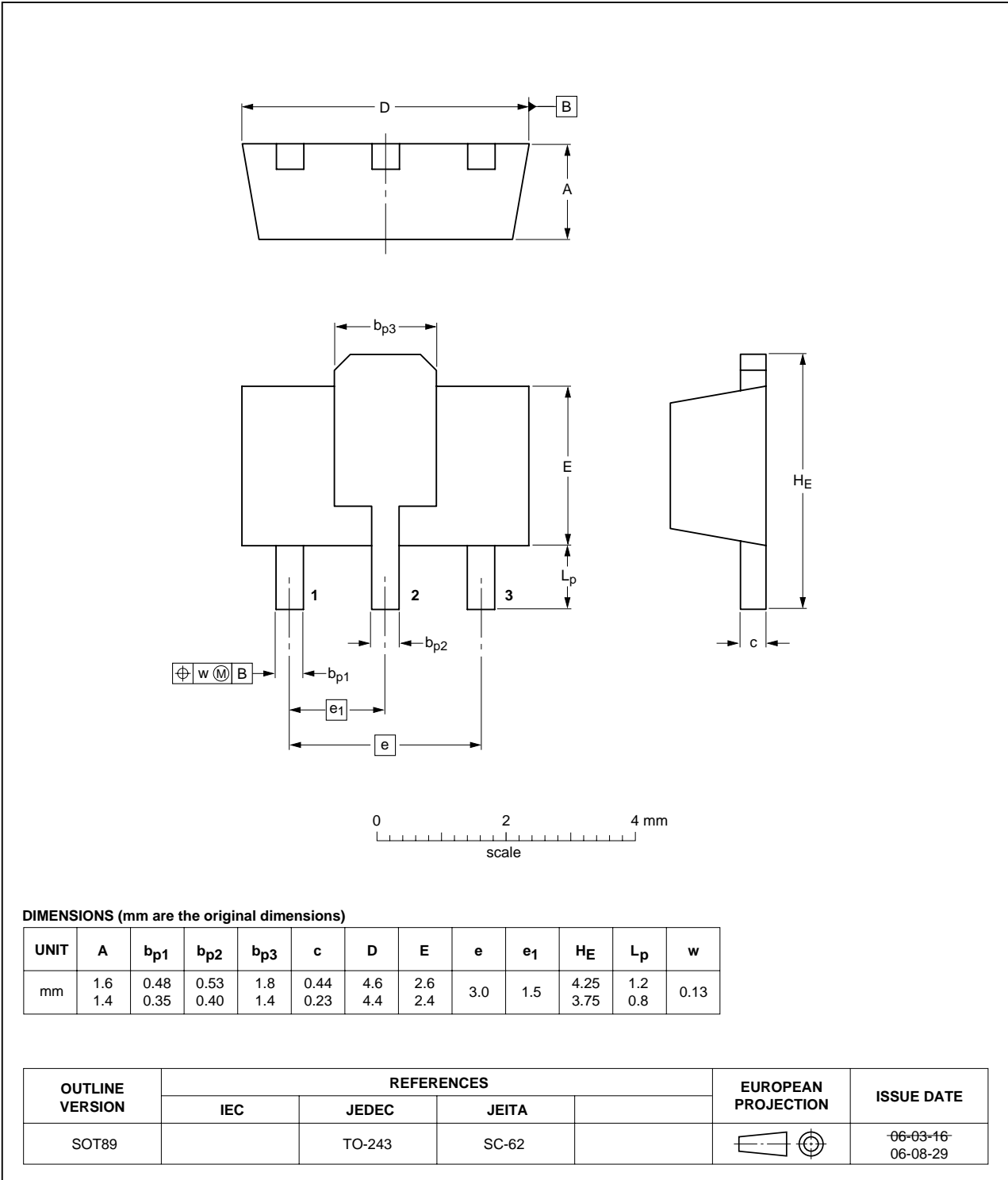

Fig 11. Package outline SOT89 (SC-62)

## 10. Abbreviations

**Table 11. Abbreviations**

Acronym	Description
CDPD	Cellular Digital Packet Data
IF	Intermediate Frequency
PCS	Personal Communication Service
SMD	Surface Mount Device
SONET	Synchronous Optical NETWORK

## 11. Revision history

**Table 12. Revision history**

Document ID	Release date	Data sheet status	Change notice	Supersedes
BGA6489_2	20090615	Product data sheet	-	BGA6489_1
Modifications:	<ul style="list-style-type: none"> <li>• The format of this data sheet has been redesigned to comply with the new identity guidelines of NXP Semiconductors.</li> <li>• Legal texts have been adapted to the new company name where appropriate.</li> <li>• Changed <math>I_S</math> from 74 mA to 78 mA throughout.</li> <li>• <a href="#">Table 1</a>: changed symbol <math>V_S</math> to <math>V_D</math>.</li> <li>• <a href="#">Table 5</a>: changed symbol <math>V_S</math> to <math>V_D</math> and added "on pin 1;" to Conditions.</li> <li>• <a href="#">Table 7</a>: added row for <math>V_D</math> DC device voltage.</li> <li>• <a href="#">Section 8</a>: added sentence.</li> <li>• <a href="#">Table 9</a>: added 39 <math>\Omega</math> to all value columns for resistor R1.</li> <li>• <a href="#">Table 9</a>: amended values of C3 and C4.</li> </ul>			
BGA6489_1	20030918	Product data sheet	-	-

## 12. Legal information

### 12.1 Data sheet status

Document status <sup>[1][2]</sup>	Product status <sup>[3]</sup>	Definition
Objective [short] data sheet	Development	This document contains data from the objective specification for product development.
Preliminary [short] data sheet	Qualification	This document contains data from the preliminary specification.
Product [short] data sheet	Production	This document contains the product specification.

[1] Please consult the most recently issued document before initiating or completing a design.

[2] The term 'short data sheet' is explained in section "Definitions".

[3] The product status of device(s) described in this document may have changed since this document was published and may differ in case of multiple devices. The latest product status information is available on the Internet at URL <http://www.nxp.com>.

### 12.2 Definitions

**Draft** — The document is a draft version only. The content is still under internal review and subject to formal approval, which may result in modifications or additions. NXP Semiconductors does not give any representations or warranties as to the accuracy or completeness of information included herein and shall have no liability for the consequences of use of such information.

**Short data sheet** — A short data sheet is an extract from a full data sheet with the same product type number(s) and title. A short data sheet is intended for quick reference only and should not be relied upon to contain detailed and full information. For detailed and full information see the relevant full data sheet, which is available on request via the local NXP Semiconductors sales office. In case of any inconsistency or conflict with the short data sheet, the full data sheet shall prevail.

### 12.3 Disclaimers

**General** — Information in this document is believed to be accurate and reliable. However, NXP Semiconductors does not give any representations or warranties, expressed or implied, as to the accuracy or completeness of such information and shall have no liability for the consequences of use of such information.

**Right to make changes** — NXP Semiconductors reserves the right to make changes to information published in this document, including without limitation specifications and product descriptions, at any time and without notice. This document supersedes and replaces all information supplied prior to the publication hereof.

**Suitability for use** — NXP Semiconductors products are not designed, authorized or warranted to be suitable for use in medical, military, aircraft, space or life support equipment, nor in applications where failure or malfunction of an NXP Semiconductors product can reasonably be expected to result in personal injury, death or severe property or environmental

damage. NXP Semiconductors accepts no liability for inclusion and/or use of NXP Semiconductors products in such equipment or applications and therefore such inclusion and/or use is at the customer's own risk.

**Applications** — Applications that are described herein for any of these products are for illustrative purposes only. NXP Semiconductors makes no representation or warranty that such applications will be suitable for the specified use without further testing or modification.

**Limiting values** — Stress above one or more limiting values (as defined in the Absolute Maximum Ratings System of IEC 60134) may cause permanent damage to the device. Limiting values are stress ratings only and operation of the device at these or any other conditions above those given in the Characteristics sections of this document is not implied. Exposure to limiting values for extended periods may affect device reliability.

**Terms and conditions of sale** — NXP Semiconductors products are sold subject to the general terms and conditions of commercial sale, as published at <http://www.nxp.com/profile/terms>, including those pertaining to warranty, intellectual property rights infringement and limitation of liability, unless explicitly otherwise agreed to in writing by NXP Semiconductors. In case of any inconsistency or conflict between information in this document and such terms and conditions, the latter will prevail.

**No offer to sell or license** — Nothing in this document may be interpreted or construed as an offer to sell products that is open for acceptance or the grant, conveyance or implication of any license under any copyrights, patents or other industrial or intellectual property rights.

**Export control** — This document as well as the item(s) described herein may be subject to export control regulations. Export might require a prior authorization from national authorities.

**Quick reference data** — The Quick reference data is an extract of the product data given in the Limiting values and Characteristics sections of this document, and as such is not complete, exhaustive or legally binding.

### 12.4 Trademarks

Notice: All referenced brands, product names, service names and trademarks are the property of their respective owners.

## 13. Contact information

For more information, please visit: <http://www.nxp.com>

For sales office addresses, please send an email to: [salesaddresses@nxp.com](mailto:salesaddresses@nxp.com)

**14. Contents**

**1 Product profile . . . . . 1**

1.1 General description. . . . . 1

1.2 Features . . . . . 1

1.3 Applications . . . . . 1

1.4 Quick reference data. . . . . 2

**2 Pinning information. . . . . 2**

**3 Ordering information. . . . . 2**

**4 Marking. . . . . 2**

**5 Limiting values. . . . . 3**

**6 Thermal characteristics. . . . . 3**

**7 Characteristics. . . . . 3**

**8 Application information. . . . . 7**

8.1 Scattering parameters . . . . . 8

**9 Package outline . . . . . 10**

**10 Abbreviations. . . . . 11**

**11 Revision history. . . . . 11**

**12 Legal information. . . . . 12**

12.1 Data sheet status . . . . . 12

12.2 Definitions . . . . . 12

12.3 Disclaimers . . . . . 12

12.4 Trademarks. . . . . 12

**13 Contact information. . . . . 12**

**14 Contents . . . . . 13**

Please be aware that important notices concerning this document and the product(s) described herein, have been included in section 'Legal information'.



## X-ON Electronics

Largest Supplier of Electrical and Electronic Components

*Click to view similar products for [RF Amplifier](#) category:*

*Click to view products by [NXP](#) manufacturer:*

Other Similar products are found below :

[A82-1](#) [BGA622H6820XTSA1](#) [BGA 728L7 E6327](#) [BGB719N7ESDE6327XTMA1](#) [HMC397-SX](#) [HMC405](#) [HMC561-SX](#) [HMC8120-SX](#)  
[HMC8121-SX](#) [HMC-ALH382-SX](#) [HMC-ALH476-SX](#) [SE2433T-R](#) [SMA3101-TL-E](#) [SMA39](#) [A66-1](#) [A66-3](#) [A67-1](#) [LX5535LQ](#) [LX5540LL](#)  
[MAAM02350](#) [HMC3653LP3BETR](#) [HMC549MS8GETR](#) [HMC-ALH435-SX](#) [SMA101](#) [SMA32](#) [SMA411](#) [SMA531](#) [SST12LP17E-XX8E](#)  
[SST12LP19E-QX6E](#) [WPM0510A](#) [HMC5929LS6TR](#) [HMC5879LS7TR](#) [HMC1126](#) [HMC1087F10](#) [HMC1086](#) [HMC1016](#) [SMA1212](#)  
[MAX2689EWS+T](#) [MAAMSS0041TR](#) [MAAM37000-A1G](#) [LTC6430AIUF-15#PBF](#) [CHA5115-QDG](#) [SMA70-2](#) [SMA4011](#) [A231](#) [HMC-](#)  
[AUH232](#) [LX5511LQ](#) [LX5511LQ-TR](#) [HMC7441-SX](#) [HMC-ALH310](#)