

BGU7003

Wideband silicon germanium low-noise amplifier MMIC

Rev. 02 — 22 June 2010

Product data sheet

1. Product profile

1.1 General description

The BGU7003 MMIC is a wideband amplifier in SiGe:C technology for high speed, low-noise applications in a plastic, leadless 6 pin, extremely thin small outline SOT891 package.

CAUTION



This device is sensitive to ElectroStatic Discharge (ESD). Therefore care should be taken during transport and handling.

1.2 Features

- Low noise high gain microwave MMIC
- Applicable between 40 MHz and 6 GHz
- Integrated temperature stabilized bias for easy design
- Bias current configurable with external resistor
- Noise figure NF = 0.80 dB at 1.575 GHz
- Insertion power gain = 18.3 dB at 1.575 GHz
- 110 GHz transit frequency - SiGe:C technology
- Power-down mode current consumption < 1 μ A
- Optimized performance at low 5 mA supply current
- ESD protection > 1 kV Human Body Model (HBM) on all pins

1.3 Applications

- GPS
- Satellite radio
- Low-noise amplifiers for microwave communications systems
- WLAN and CDMA applications
- Analog / digital cordless applications

1.4 Quick reference data

Table 1. Quick reference data

$T_{amb} = 25\text{ °C}$; $V_{CC} = 2.5\text{ V}$; $I_{CC(tot)} = 5.0\text{ mA}$; $V_{ENABLE} \geq 0.7\text{ V}$; $f = 1575\text{ MHz}$; $Z_S = Z_L = 50\ \Omega$ (input and output matched to $50\ \Omega$) unless otherwise specified.

Symbol	Parameter	Conditions	Min	Typ	Max	Unit
V_{CC}	supply voltage	RF input AC coupled	2.2	-	2.85	V
$I_{CC(tot)}$	total supply current	configurable with external resistor	[1] 3	-	15	mA
T_{amb}	ambient temperature		-40	+25	+85	°C
P_{tot}	total power dissipation	$T_{sp} \leq 103\text{ °C}$	[2] -	-	70	mW
$ S_{21} ^2$	Insertion power gain		-	18.3	-	dB
NF	noise figure		-	0.80	-	dB
$P_{i(1dB)}$	input power at 1 dB gain compression		-	-20.1	-	dBm
$IP3_1$	input third-order intercept point	jammers at $f_1 = f + 138\text{ MHz}$ and $f_2 = f + 276\text{ MHz}$	-	-0.2	-	dBm

[1] $I_{CC(tot)} = I_{CC} + I_{RF_OUT} + I_{R_BIAS}$.

[2] T_{sp} is the temperature at the solder point of the ground lead.

2. Pinning information

Table 2. Pinning

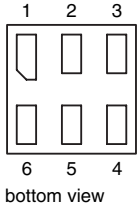
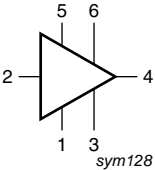
Pin	Description	Simplified outline	Graphic symbol
1	R_BIAS	 <p style="text-align: center;">bottom view</p>	 <p style="text-align: center;">sym128</p>
2	RF_IN		
3	GND		
4	RF_OUT		
5	ENABLE		
6	V_{CC}		

3. Ordering information

Table 3. Ordering information

Type number	Package		
	Name	Description	Version
BGU7003	XSON6	plastic extremely thin small outline package; no leads; 6 terminals; body $1 \times 1 \times 0.5\text{ mm}$	SOT891

4. Marking

Table 4. Marking codes

Type number	Marking code
BGU7003	B3

5. Limiting values

Table 5. Limiting values

In accordance with the Absolute Maximum Rating System (IEC 60134).

Symbol	Parameter	Conditions	Min	Max	Unit
V _{CC}	supply voltage	RF input AC coupled	-	3.0	V
I _{CC(tot)}	total supply current	configurable with external resistor	-	25	mA
P _{tot}	total power dissipation	T _{sp} ≤ 103 °C	[1]	70	mW
T _{stg}	storage temperature		-65	+150	°C
T _j	junction temperature		-	150	°C

[1] T_{sp} is the temperature at the solder point of the ground lead.

6. Thermal characteristics

Table 6. Thermal characteristics

Symbol	Parameter	Conditions	Typ	Unit
R _{th(j-sp)}	thermal resistance from junction to solder point		235	K/W

7. Characteristics

Table 7. Characteristics

T_{amb} = 25 °C; V_{CC} = 2.5 V; I_{CC(tot)} = 5.0 mA; V_{ENABLE} ≥ 0.7 V unless otherwise specified. All measurements done on characterization board without matching, de-embedded up to the pins.

Symbol	Parameter	Conditions	Min	Typ	Max	Unit
V _{CC}	supply voltage	RF input AC coupled	2.2	-	2.85	V
I _{CC(tot)}	total supply current	configurable with external resistor	[1]	3	-	15 mA
		V _{ENABLE} ≤ 0.4 V	[1]	-	-	0.001 mA
T _{amb}	ambient temperature		-40	+25	+85	°C
S ₂₁ ²	insertion power gain	T _{amb} = 25 °C				
		f = 1.575 GHz	16.0	17.5	-	dB
		f = 2.4 GHz	[2]	14.0	15.2	dB
		f = 5.8 GHz	[2]	10.0	11.4	dB
		-40 °C ≤ T _{amb} ≤ 85 °C				
		f = 1.575 GHz	[2]	15.0	17.5	dB
		f = 2.4 GHz	[2]	13.0	15.2	dB
		f = 5.8 GHz	[2]	9.0	11.4	dB
MSG	maximum stable gain	f = 1.575 GHz	-	20.5	-	dB
		f = 2.4 GHz	-	17.8	-	dB
		f = 5.8 GHz	-	15.4	-	dB
NF _{min}	minimum noise figure	f = 1.575 GHz	-	0.70	-	dB
		f = 2.4 GHz	-	0.80	-	dB
		f = 5.8 GHz	-	1.5	-	dB

[1] I_{CC(tot)} = I_{CC} + I_{RF_OUT} + I_{R_BIAS}.

[2] Guaranteed by design and characterization.

Table 8. ENABLE (pin 5)

$-40\text{ }^{\circ}\text{C} \leq T_{\text{amb}} \leq +85\text{ }^{\circ}\text{C}$

V_{ENABLE} (V)	State
≤ 0.4	OFF
≥ 0.7	ON

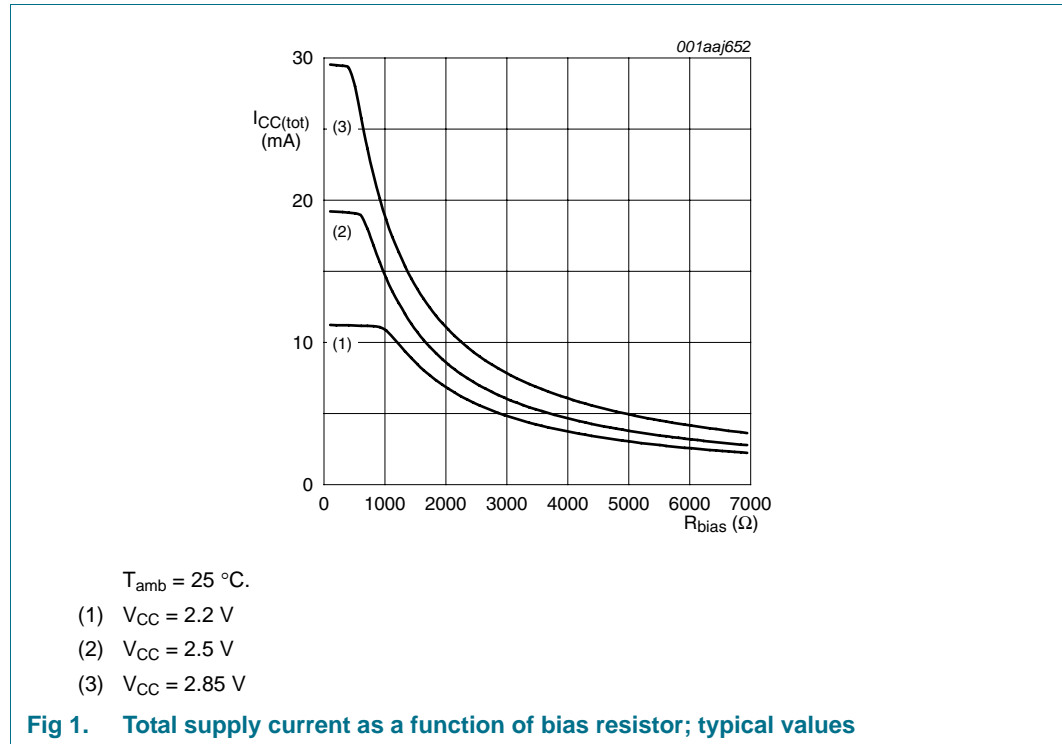

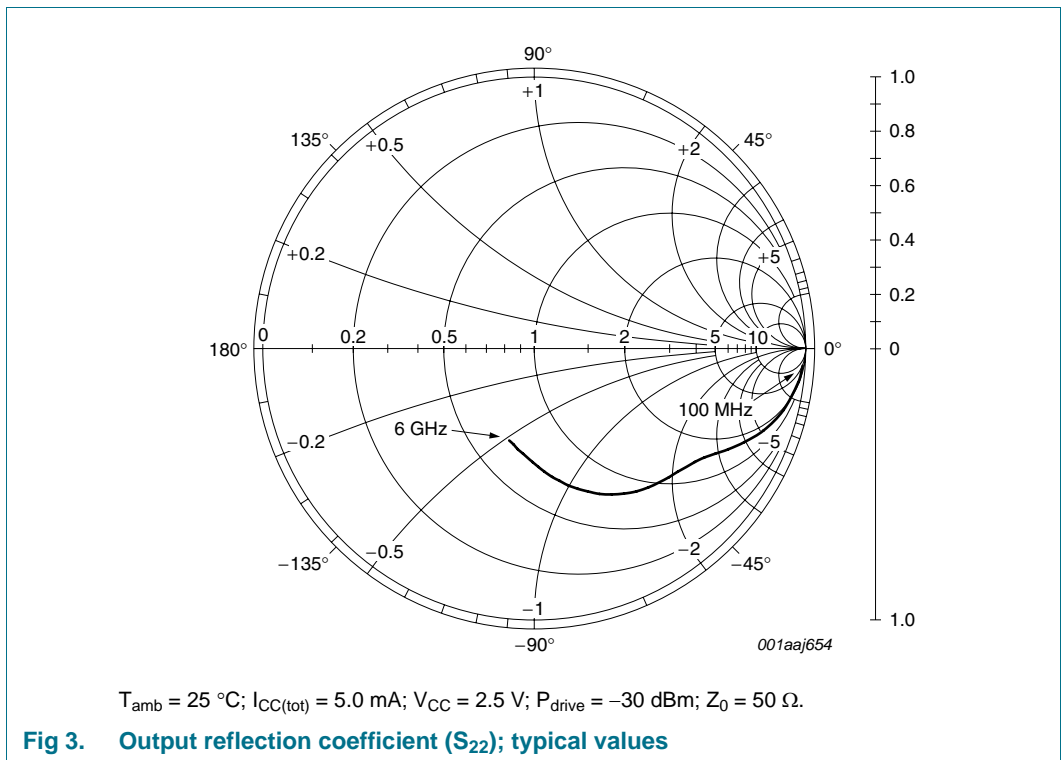
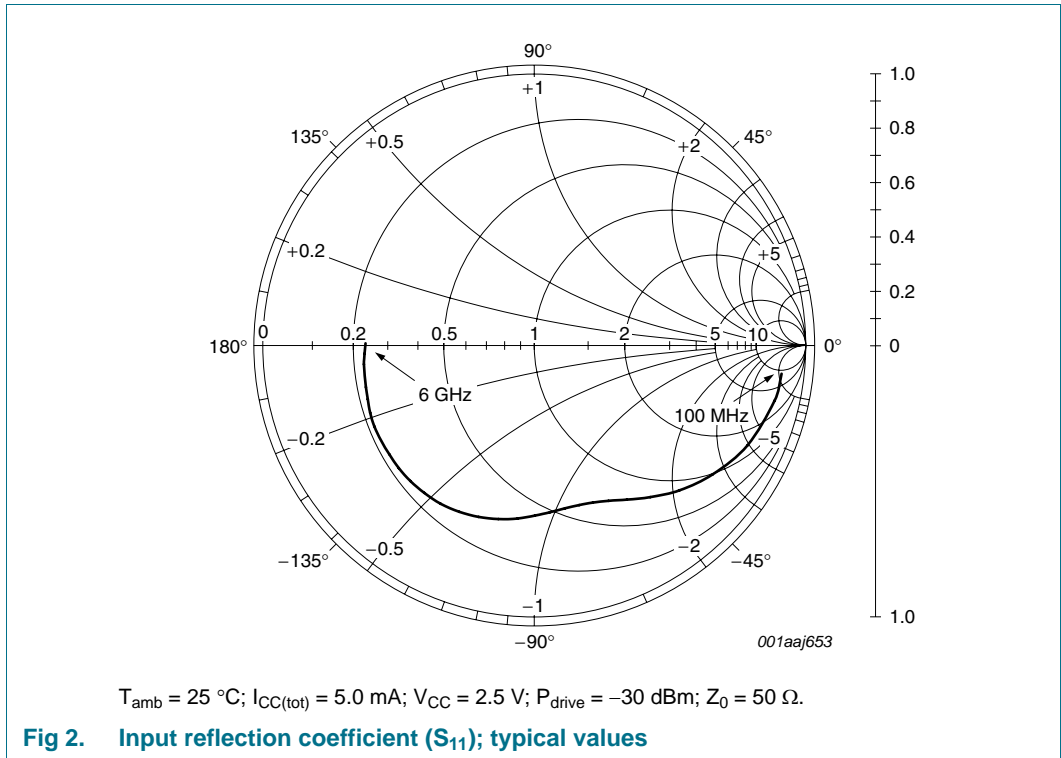

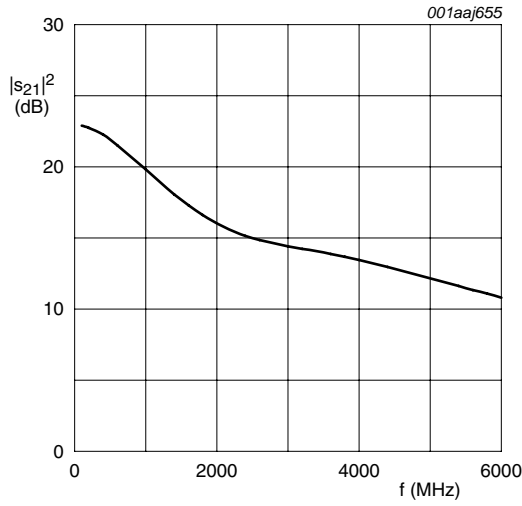

$T_{amb} = 25\text{ }^\circ\text{C}$; $I_{CC(tot)} = 5.0\text{ mA}$; $V_{CC} = 2.5\text{ V}$;
 $P_{drive} = -30\text{ dBm}$; $Z_0 = 50\text{ }\Omega$.

Fig 4. Insertion power gain ($|s_{21}|^2$) as a function of frequency; typical values

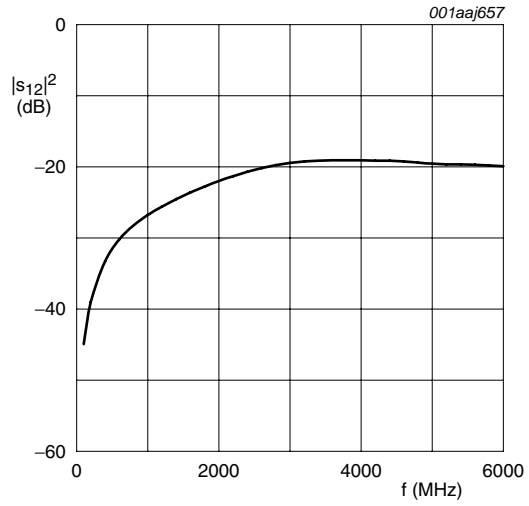

$T_{amb} = 25\text{ }^\circ\text{C}$; $I_{CC(tot)} = 5.0\text{ mA}$; $V_{CC} = 2.5\text{ V}$;
 $P_{drive} = -30\text{ dBm}$; $Z_0 = 50\text{ }\Omega$.

Fig 5. Isolation ($|s_{12}|^2$) as a function of frequency; typical values

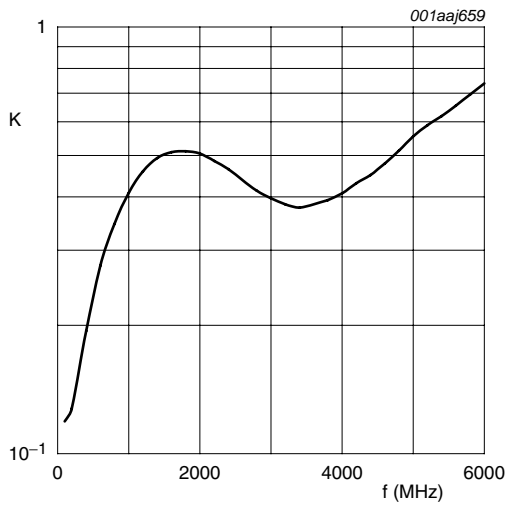

$T_{amb} = 25\text{ }^\circ\text{C}$; $I_{CC(tot)} = 5.0\text{ mA}$; $V_{CC} = 2.5\text{ V}$;
 $P_{drive} = -30\text{ dBm}$; $Z_0 = 50\text{ }\Omega$.

Fig 6. Rollet's stability factor as a function of frequency; typical values

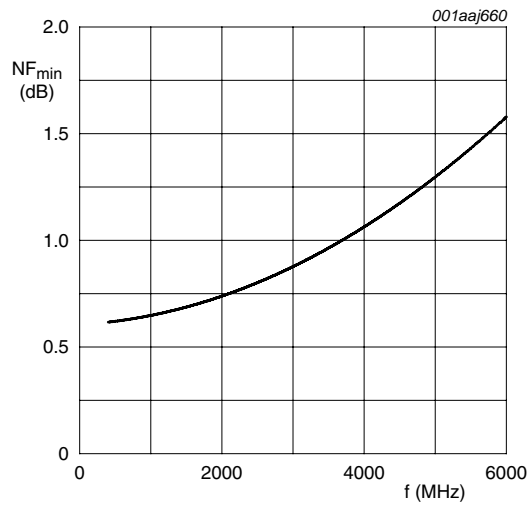

$T_{amb} = 25\text{ }^\circ\text{C}$; $I_{CC(tot)} = 5.0\text{ mA}$; $V_{CC} = 2.5\text{ V}$;
 $P_{drive} = -30\text{ dBm}$; $Z_0 = 50\text{ }\Omega$.

Fig 7. Minimum noise figure as a function of frequency; typical values

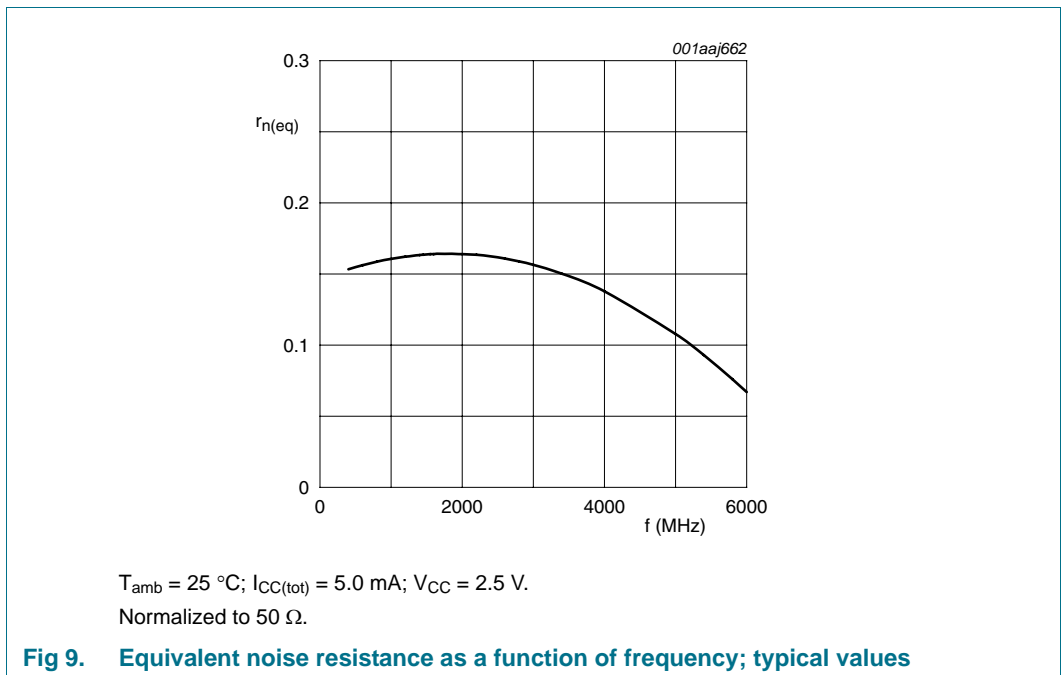
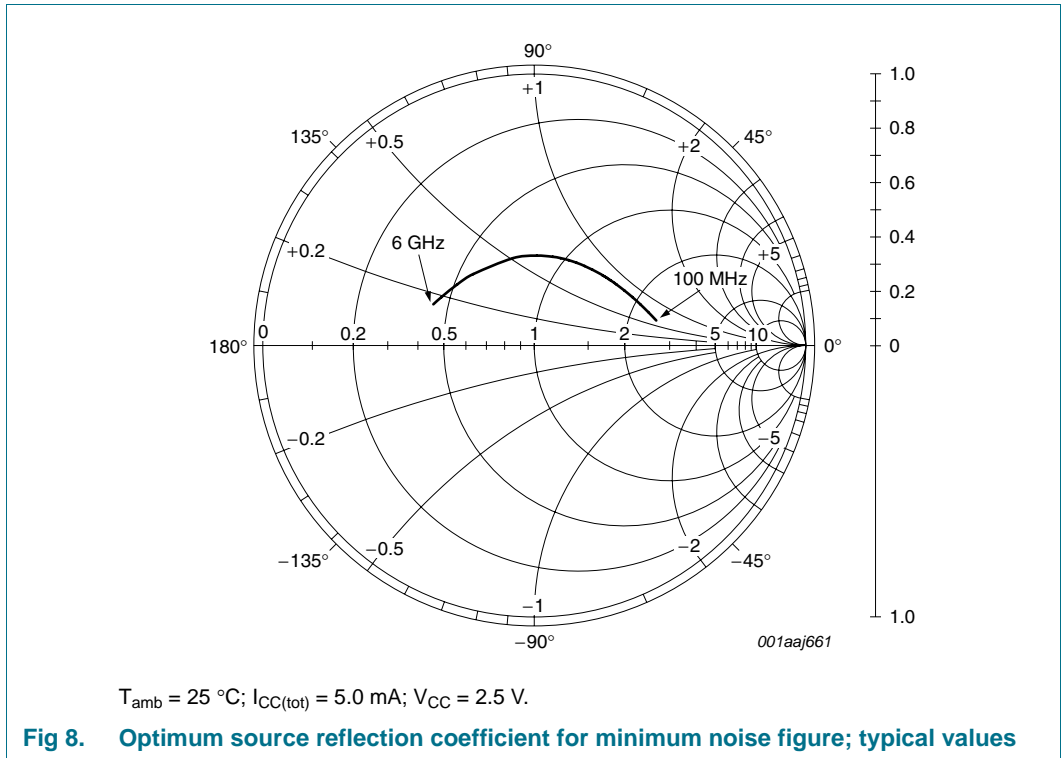

8. Application information GPS LNA

Other applications available. Please contact your local sales representative for more information. Application note(s) available on the NXP website.

8.1 Application circuit

In [Figure 10](#) the application diagram as supplied on the evaluation board is given.

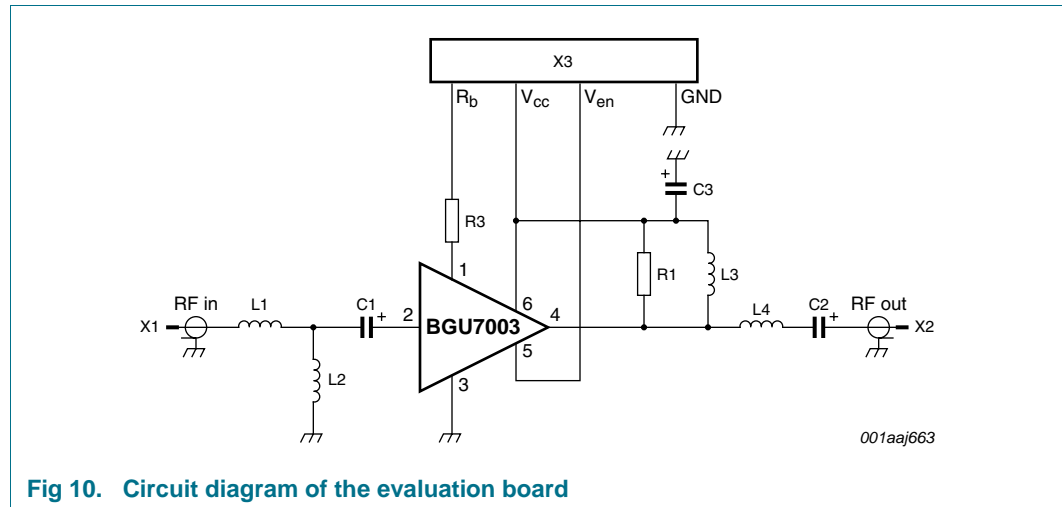

Fig 10. Circuit diagram of the evaluation board

Table 9. List of components

For circuit, see [Figure 10](#).

Component	Description	Value	Supplier name/type	Remarks
C1, C2	capacitor	100 pF	[1] MurataGRM1555	DC blocking
C3	capacitor	180 pF	[1] MurataGRM1555	decoupling
L1	inductor	2.7 nH	[1] Murata/LQW15A high quality factor, low series resistance	input matching
L2	inductor	33 nH	[1] Murata/LQW15A high quality factor, low series resistance	input matching
L3	inductor	3.9 nH	[1] Murata/LQG15HS	output matching / DC shunt
L4	inductor	4.7 nH	[1] Murata/LQG15HS	output matching
R1	resistor	180 Ω	[1]	
R2	resistor	0 Ω	[1]	bridge
R3	resistor	3300 Ω	[1]	bias setting
X1, X2	SMA RF connector	-	Johnson, end launch SMA 142-0701-841	RF input / RF output
X3	DC header	-	Molex, PCB header, right angle, 1 row, 4 way 90121-0764	bias connector

[1] all capacitors, inductors and resistors have 0402 footprint.

8.2 Application board layout

Figure 11 shows the board layout with component identifications.

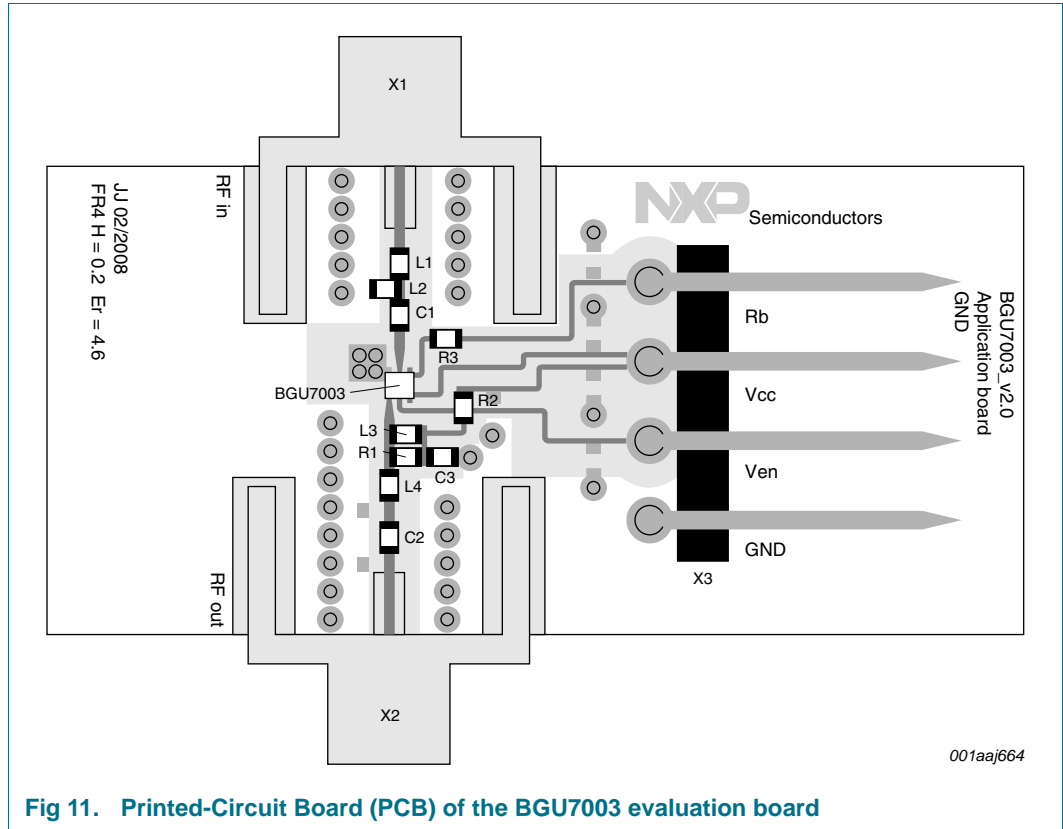

Fig 11. Printed-Circuit Board (PCB) of the BGU7003 evaluation board

8.3 Printed-Circuit Board

The material that has been used for the evaluation board is FR4 using the stack shown in Figure 12.

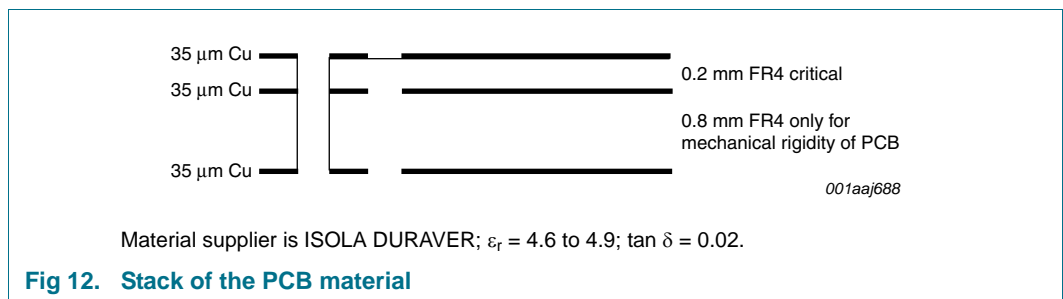

Fig 12. Stack of the PCB material

8.4 GPS evaluation board

Table 10. GPS application characteristics

$T_{amb} = 25\text{ }^{\circ}\text{C}$; $V_{CC} = 2.5\text{ V}$; $I_{CC(tot)} = 5.0\text{ mA}$; $f = 1.575\text{ GHz}$; $V_{ENABLE} \geq 0.7\text{ V}$; $Z_S = Z_L = 50\text{ }\Omega$ (input and output matched to $50\text{ }\Omega$) unless otherwise specified.

Symbol	Parameter	Conditions	Min	Typ	Max	Unit
$ S_{21} ^2$	Insertion power gain		-	18.3	-	dB
$ S_{11} ^2$	input return loss		-	-5.4	-	dB
$ S_{22} ^2$	output return loss		-	-19.5	-	dB
$ S_{12} ^2$	isolation		-	-24.6	-	dB
NF	noise figure		-	0.80	-	dB
$P_{i(1dB)}$	input power at 1 dB gain compression		-	-20.1	-	dBm
$P_{L(1dB)}$	output power at 1 dB gain compression		-	-2.8	-	dBm
$IP3_1$	input third-order intercept point	jammers at $f_1 = f + 138\text{ MHz}$ and $f_2 = f + 276\text{ MHz}$	-	-0.2	-	dBm
		$f_1 = f + 5\text{ MHz}$; $f_2 = f + 10\text{ MHz}$	-	-5.2	-	dBm

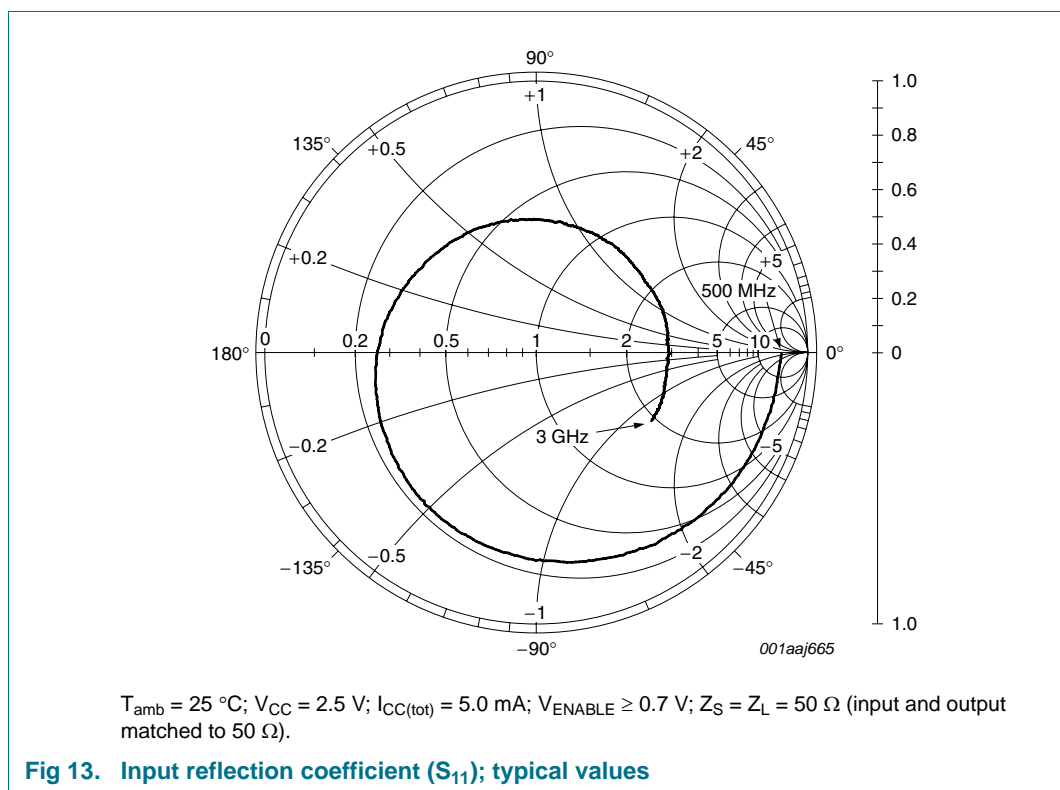

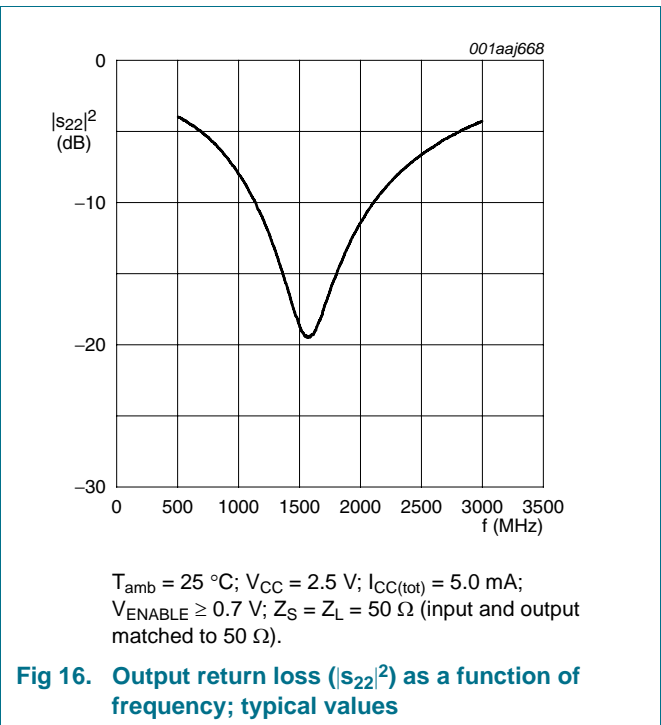
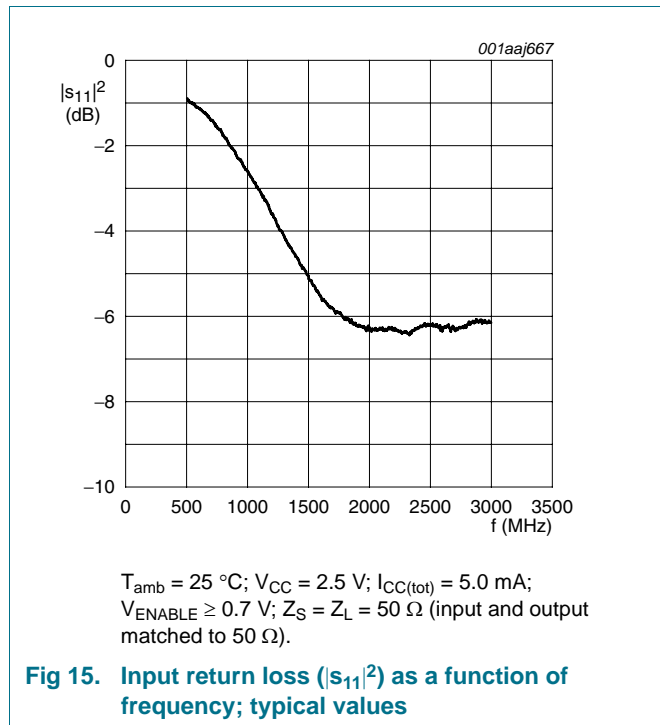
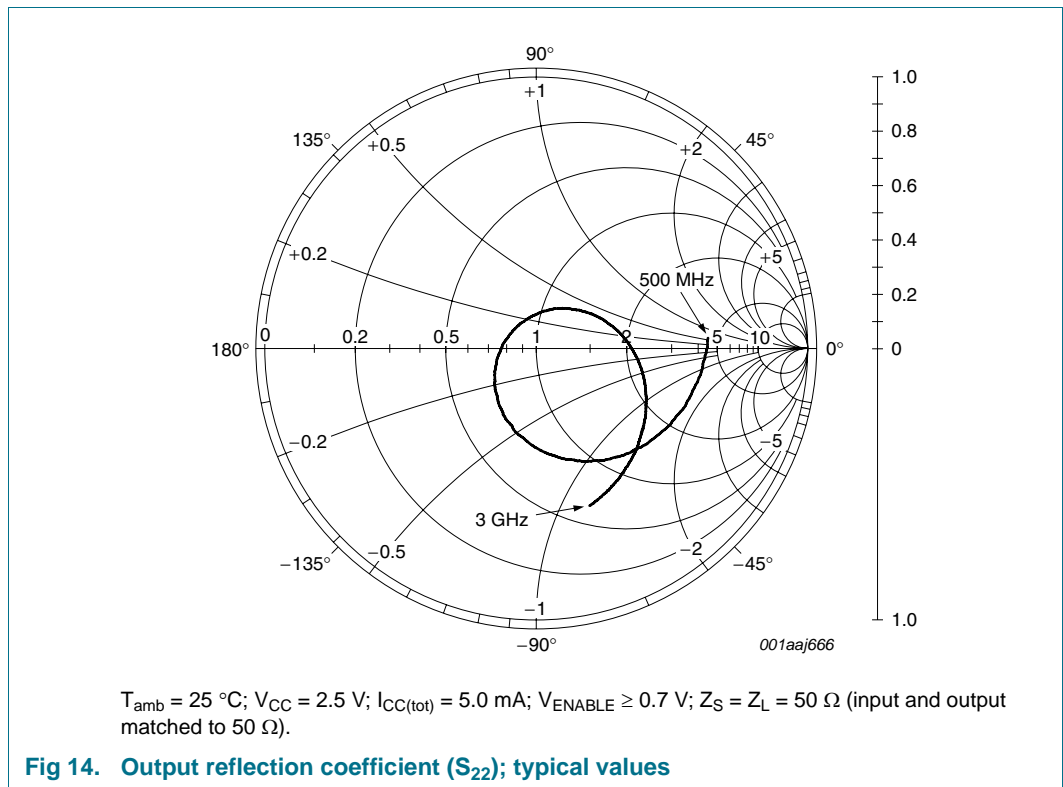

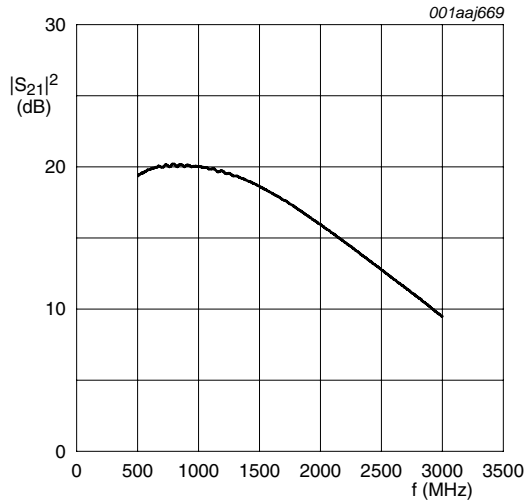

$T_{amb} = 25\text{ }^{\circ}\text{C}$; $V_{CC} = 2.5\text{ V}$; $I_{CC(tot)} = 5.0\text{ mA}$;
 $V_{ENABLE} \geq 0.7\text{ V}$; $Z_S = Z_L = 50\text{ }\Omega$ (input and output
 matched to $50\text{ }\Omega$).

Fig 17. Insertion power gain ($|s_{21}|^2$) as a function of frequency; typical values

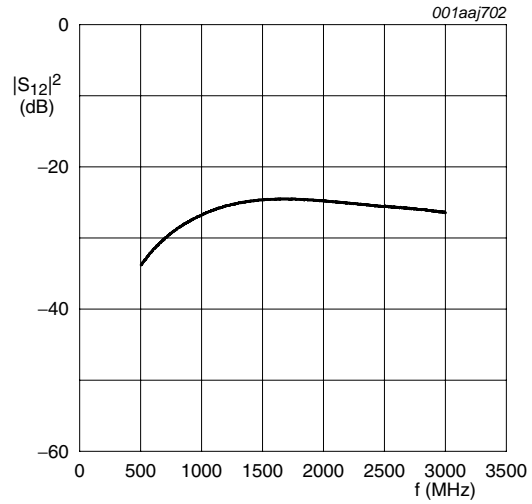

$T_{amb} = 25\text{ }^{\circ}\text{C}$; $V_{CC} = 2.5\text{ V}$; $I_{CC(tot)} = 5.0\text{ mA}$;
 $V_{ENABLE} \geq 0.7\text{ V}$; $Z_S = Z_L = 50\text{ }\Omega$ (input and output
 matched to $50\text{ }\Omega$).

Fig 18. Reverse Isolation ($|s_{12}|^2$) as a function of frequency; typical values

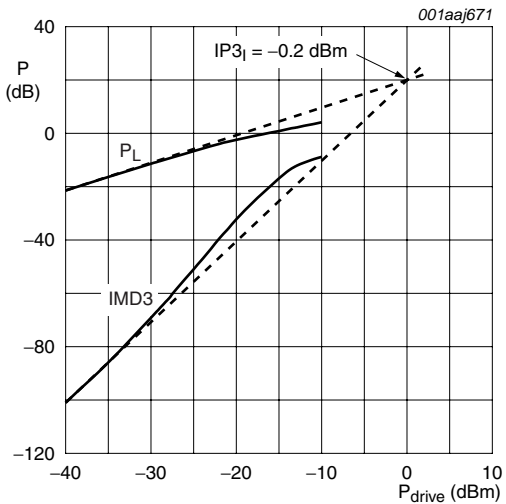

$T_{amb} = 25\text{ }^{\circ}\text{C}$; $V_{CC} = 2.5\text{ V}$; $I_{CC(tot)} = 5.0\text{ mA}$;
 $f = 1.575\text{ GHz}$; $f_1 = f + 138\text{ MHz}$; $f_2 = f + 276\text{ MHz}$;
 $V_{ENABLE} \geq 0.7\text{ V}$; $Z_S = Z_L = 50\text{ }\Omega$ (input and output
 matched to $50\text{ }\Omega$)

Fig 19. Load power and third order intermodulation distortion as function of drive power; typical values

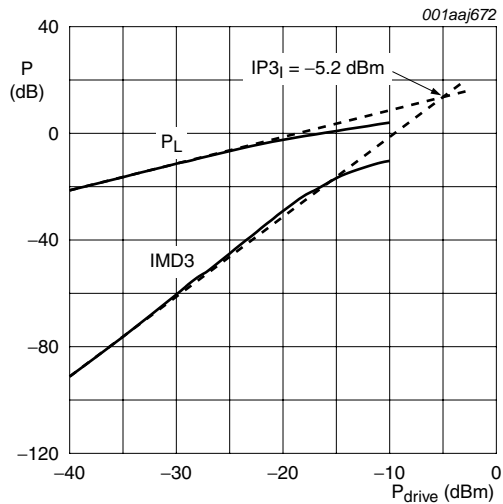

$T_{amb} = 25\text{ }^{\circ}\text{C}$; $V_{CC} = 2.5\text{ V}$; $I_{CC(tot)} = 5.0\text{ mA}$;
 $f = 1.575\text{ GHz}$; $f_1 = f + 5\text{ MHz}$; $f_2 = f + 10\text{ MHz}$;
 $V_{ENABLE} \geq 0.7\text{ V}$; $Z_S = Z_L = 50\text{ }\Omega$ (input and output
 matched to $50\text{ }\Omega$)

Fig 20. Load power and third order intermodulation distortion as function of drive power; typical values

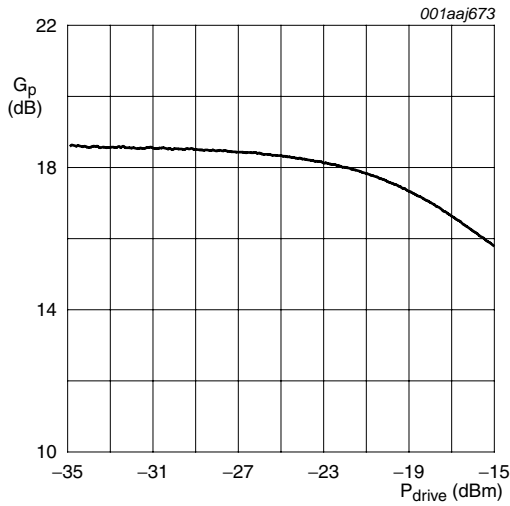

T_{amb} = 25 °C; V_{CC} = 2.5 V; I_{CC(tot)} = 5.0 mA;
 f = 1.575 GHz; V_{ENABLE} ≥ 0.7 V; Z_S = Z_L = 50 Ω (input and output matched to 50 Ω).

Fig 21. Power gain as a function of drive power; typical values

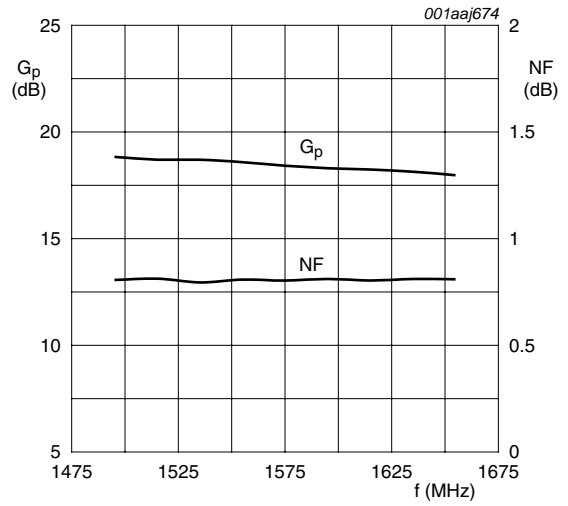

T_{amb} = 25 °C; V_{CC} = 2.5 V; I_{CC(tot)} = 5.0 mA;
 V_{ENABLE} ≥ 0.7 V; Z_S = Z_L = 50 Ω (input and output matched to 50 Ω).

Fig 22. Power gain and noise figure as function of frequency; typical values

9. Package outline

XSON6: plastic extremely thin small outline package; no leads; 6 terminals; body 1 x 1 x 0.5 mm

SOT891

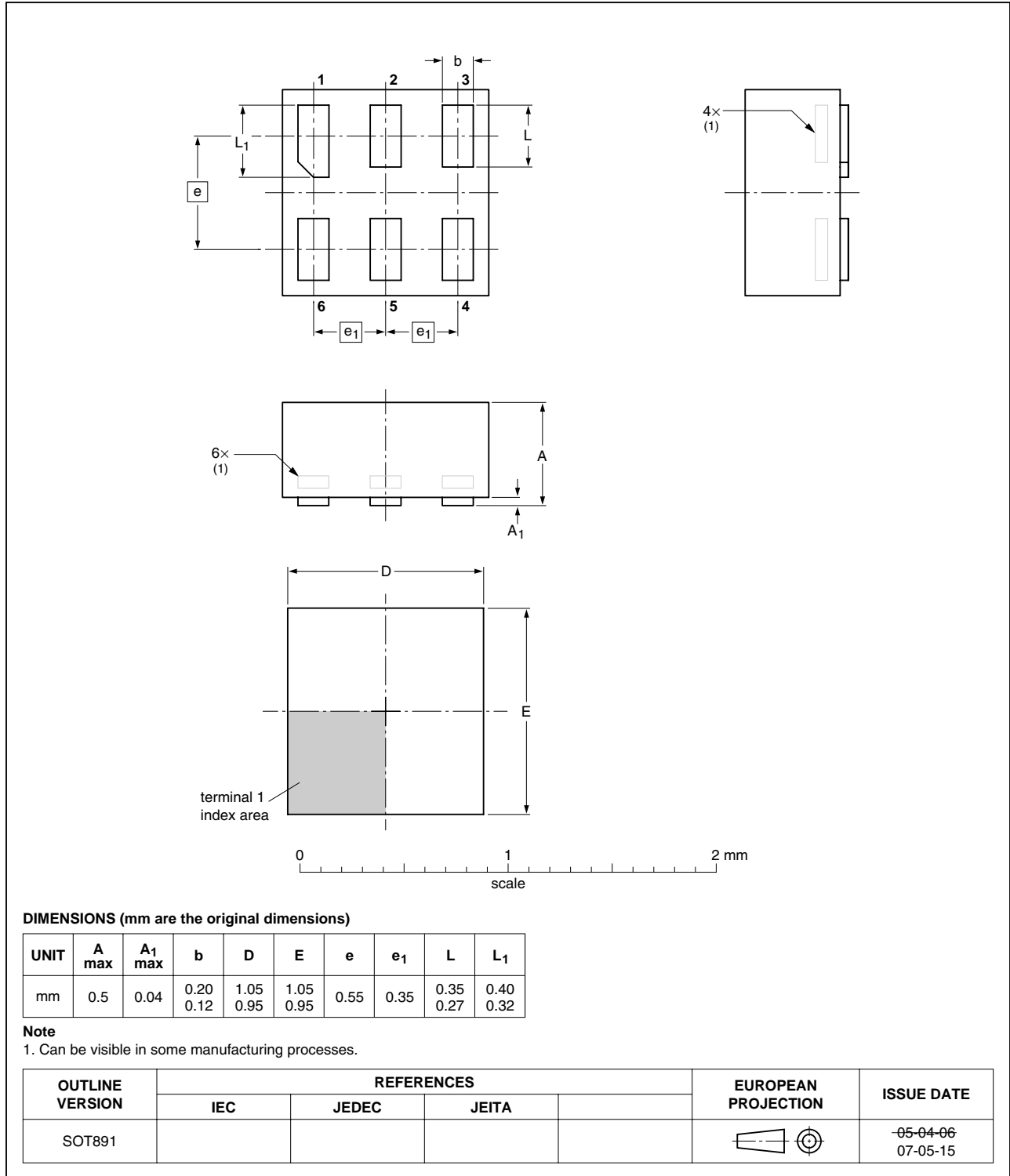
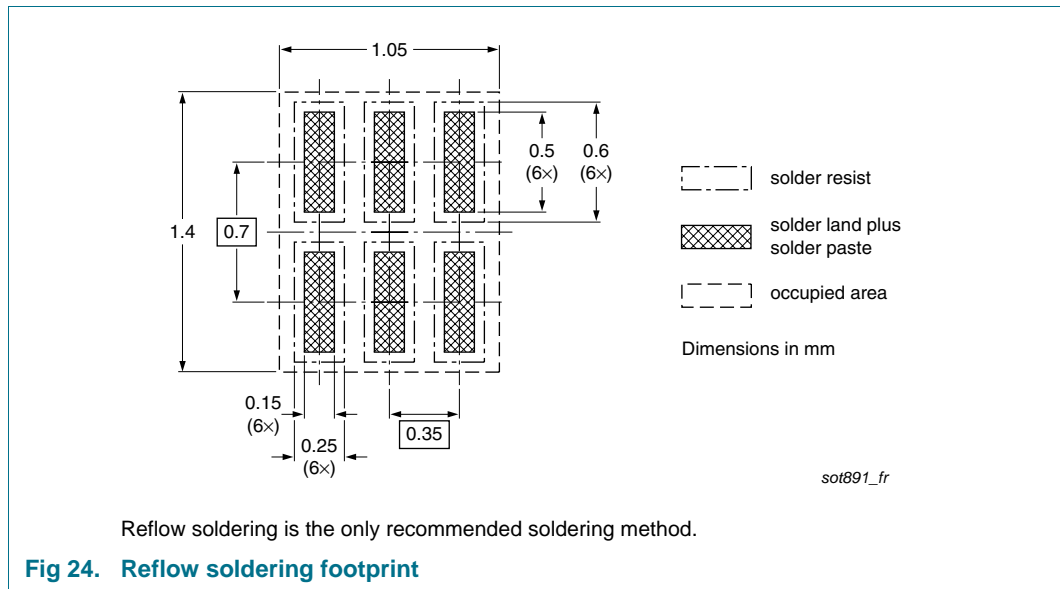

Fig 23. Package outline SOT891 (XSON6)

10. Soldering



11. Abbreviations

Table 11. Abbreviations

Acronym	Description
AC	Alternating Current
CDMA	Code Division Multiple Access
DC	Direct Current
FR4	Flame Retardant 4
GPS	Global Positioning System
LNA	Low-Noise Amplifier
MMIC	Monolithic Microwave Integrated Circuit
RF	Radio Frequency
SiGe:C	Silicon Germanium Carbon
SMA	SubMiniature version A
WLAN	Wireless Local Area Network

12. Revision history

Table 12. Revision history

Document ID	Release date	Data sheet status	Change notice	Supersedes
BGU7003 v.2	20100622	Product data sheet	-	BGU7003 v.1
Modifications:	<ul style="list-style-type: none"> Legal information updated. 			
BGU7003 v.1	20090302	Product data sheet	-	-

13. Legal information

13.1 Data sheet status

Document status ^{[1][2]}	Product status ^[3]	Definition
Objective [short] data sheet	Development	This document contains data from the objective specification for product development.
Preliminary [short] data sheet	Qualification	This document contains data from the preliminary specification.
Product [short] data sheet	Production	This document contains the product specification.

[1] Please consult the most recently issued document before initiating or completing a design.

[2] The term 'short data sheet' is explained in section "Definitions".

[3] The product status of device(s) described in this document may have changed since this document was published and may differ in case of multiple devices. The latest product status information is available on the Internet at URL <http://www.nxp.com>.

13.2 Definitions

Draft — The document is a draft version only. The content is still under internal review and subject to formal approval, which may result in modifications or additions. NXP Semiconductors does not give any representations or warranties as to the accuracy or completeness of information included herein and shall have no liability for the consequences of use of such information.

Short data sheet — A short data sheet is an extract from a full data sheet with the same product type number(s) and title. A short data sheet is intended for quick reference only and should not be relied upon to contain detailed and full information. For detailed and full information see the relevant full data sheet, which is available on request via the local NXP Semiconductors sales office. In case of any inconsistency or conflict with the short data sheet, the full data sheet shall prevail.

Product specification — The information and data provided in a Product data sheet shall define the specification of the product as agreed between NXP Semiconductors and its customer, unless NXP Semiconductors and customer have explicitly agreed otherwise in writing. In no event however, shall an agreement be valid in which the NXP Semiconductors product is deemed to offer functions and qualities beyond those described in the Product data sheet.

13.3 Disclaimers

Limited warranty and liability — Information in this document is believed to be accurate and reliable. However, NXP Semiconductors does not give any representations or warranties, expressed or implied, as to the accuracy or completeness of such information and shall have no liability for the consequences of use of such information.

In no event shall NXP Semiconductors be liable for any indirect, incidental, punitive, special or consequential damages (including - without limitation - lost profits, lost savings, business interruption, costs related to the removal or replacement of any products or rework charges) whether or not such damages are based on tort (including negligence), warranty, breach of contract or any other legal theory.

Notwithstanding any damages that customer might incur for any reason whatsoever, NXP Semiconductors' aggregate and cumulative liability towards customer for the products described herein shall be limited in accordance with the *Terms and conditions of commercial sale* of NXP Semiconductors.

Right to make changes — NXP Semiconductors reserves the right to make changes to information published in this document, including without limitation specifications and product descriptions, at any time and without notice. This document supersedes and replaces all information supplied prior to the publication hereof.

Suitability for use — NXP Semiconductors products are not designed, authorized or warranted to be suitable for use in life support, life-critical or safety-critical systems or equipment, nor in applications where failure or

malfunction of an NXP Semiconductors product can reasonably be expected to result in personal injury, death or severe property or environmental damage. NXP Semiconductors accepts no liability for inclusion and/or use of NXP Semiconductors products in such equipment or applications and therefore such inclusion and/or use is at the customer's own risk.

Applications — Applications that are described herein for any of these products are for illustrative purposes only. NXP Semiconductors makes no representation or warranty that such applications will be suitable for the specified use without further testing or modification.

Customers are responsible for the design and operation of their applications and products using NXP Semiconductors products, and NXP Semiconductors accepts no liability for any assistance with applications or customer product design. It is customer's sole responsibility to determine whether the NXP Semiconductors product is suitable and fit for the customer's applications and products planned, as well as for the planned application and use of customer's third party customer(s). Customers should provide appropriate design and operating safeguards to minimize the risks associated with their applications and products.

NXP Semiconductors does not accept any liability related to any default, damage, costs or problem which is based on any weakness or default in the customer's applications or products, or the application or use by customer's third party customer(s). Customer is responsible for doing all necessary testing for the customer's applications and products using NXP Semiconductors products in order to avoid a default of the applications and the products or of the application or use by customer's third party customer(s). NXP does not accept any liability in this respect.

Limiting values — Stress above one or more limiting values (as defined in the Absolute Maximum Ratings System of IEC 60134) will cause permanent damage to the device. Limiting values are stress ratings only and (proper) operation of the device at these or any other conditions above those given in the Recommended operating conditions section (if present) or the Characteristics sections of this document is not warranted. Constant or repeated exposure to limiting values will permanently and irreversibly affect the quality and reliability of the device.

Terms and conditions of commercial sale — NXP Semiconductors products are sold subject to the general terms and conditions of commercial sale, as published at <http://www.nxp.com/profile/terms>, unless otherwise agreed in a valid written individual agreement. In case an individual agreement is concluded only the terms and conditions of the respective agreement shall apply. NXP Semiconductors hereby expressly objects to applying the customer's general terms and conditions with regard to the purchase of NXP Semiconductors products by customer.

No offer to sell or license — Nothing in this document may be interpreted or construed as an offer to sell products that is open for acceptance or the grant, conveyance or implication of any license under any copyrights, patents or other industrial or intellectual property rights.

Export control — This document as well as the item(s) described herein may be subject to export control regulations. Export might require a prior authorization from national authorities.

Quick reference data — The Quick reference data is an extract of the product data given in the Limiting values and Characteristics sections of this document, and as such is not complete, exhaustive or legally binding.

Non-automotive qualified products — Unless this data sheet expressly states that this specific NXP Semiconductors product is automotive qualified, the product is not suitable for automotive use. It is neither qualified nor tested in accordance with automotive testing or application requirements. NXP Semiconductors accepts no liability for inclusion and/or use of non-automotive qualified products in automotive equipment or applications.

In the event that customer uses the product for design-in and use in automotive applications to automotive specifications and standards, customer (a) shall use the product without NXP Semiconductors' warranty of the

product for such automotive applications, use and specifications, and (b) whenever customer uses the product for automotive applications beyond NXP Semiconductors' specifications such use shall be solely at customer's own risk, and (c) customer fully indemnifies NXP Semiconductors for any liability, damages or failed product claims resulting from customer design and use of the product for automotive applications beyond NXP Semiconductors' standard warranty and NXP Semiconductors' product specifications.

13.4 Trademarks

Notice: All referenced brands, product names, service names and trademarks are the property of their respective owners.

14. Contact information

For more information, please visit: <http://www.nxp.com>

For sales office addresses, please send an email to: salesaddresses@nxp.com

15. Contents

1 Product profile 1

1.1 General description 1

1.2 Features 1

1.3 Applications 1

1.4 Quick reference data 2

2 Pinning information 2

3 Ordering information 2

4 Marking 2

5 Limiting values 3

6 Thermal characteristics 3

7 Characteristics 3

8 Application information GPS LNA 8

8.1 Application circuit 8

8.2 Application board layout 9

8.3 Printed-Circuit Board 9

8.4 GPS evaluation board 10

9 Package outline 14

10 Soldering 15

11 Abbreviations 15

12 Revision history 15

13 Legal information 16

13.1 Data sheet status 16

13.2 Definitions 16

13.3 Disclaimers 16

13.4 Trademarks 17

14 Contact information 17

15 Contents 18

Please be aware that important notices concerning this document and the product(s) described herein, have been included in section 'Legal information'.



© NXP B.V. 2010.

All rights reserved.

For more information, please visit: <http://www.nxp.com>

For sales office addresses, please send an email to: salesaddresses@nxp.com

Date of release: 22 June 2010

Document identifier: BGU7003

X-ON Electronics

Largest Supplier of Electrical and Electronic Components

Click to view similar products for [RF Amplifier](#) category:

Click to view products by [NXP](#) manufacturer:

Other Similar products are found below :

[A82-1](#) [BGA622H6820XTSA1](#) [BGA 728L7 E6327](#) [BGB719N7ESDE6327XTMA1](#) [HMC397-SX](#) [HMC405](#) [HMC561-SX](#) [HMC8120-SX](#)
[HMC8121-SX](#) [HMC-ALH382-SX](#) [HMC-ALH476-SX](#) [SE2433T-R](#) [SMA3101-TL-E](#) [SMA39](#) [A66-1](#) [A66-3](#) [A67-1](#) [LX5535LQ](#) [LX5540LL](#)
[MAAM02350](#) [HMC3653LP3BETR](#) [HMC549MS8GETR](#) [HMC-ALH435-SX](#) [SMA101](#) [SMA32](#) [SMA411](#) [SMA531](#) [SST12LP17E-XX8E](#)
[SST12LP19E-QX6E](#) [WPM0510A](#) [HMC5929LS6TR](#) [HMC5879LS7TR](#) [HMC1126](#) [HMC1087F10](#) [HMC1086](#) [HMC1016](#) [SMA1212](#)
[MAX2689EWS+T](#) [MAAMSS0041TR](#) [MAAM37000-A1G](#) [LTC6430AIUF-15#PBF](#) [CHA5115-QDG](#) [SMA70-2](#) [SMA4011](#) [A231](#) [HMC-](#)
[AUH232](#) [LX5511LQ](#) [LX5511LQ-TR](#) [HMC7441-SX](#) [HMC-ALH310](#)