

FRDM-KW36 RF System Evaluation Report for the Bluetooth LE applications

1. Introduction

This document provides the RF evaluation test results of FRDM-KW36 for Bluetooth LE applications (2FSK modulation). It includes the test setup description and tools for you to perform the tests on your own. For the KW36 radio parameters, see the *KW35A/36A/35Z/36Z Data Sheet* (document [MKW36Z512](#)).

For more information about the FRDM-KW36Z Freedom development board, see the *FRDM-KW36Z Freedom Development Board User's Guide* (document [FRDMKW36ZUG](#)). Find the schematic and design files at this [link](#).

Contents

1.	Introduction.....	1
1.1.	List of tests.....	3
1.2.	Software.....	3
1.3.	List of equipment.....	4
2.	Tests summary	5
3.	Conducted tests	7
3.1.	TX tests.....	7
3.2.	RX tests.....	45
3.3.	Return loss	59
4.	Radiated tests	66
4.1.	RX test setup.....	66
4.2.	RX spurious	67
5.	Antenna measurements	68
5.1.	Return loss	68
6.	Conclusion	69
7.	References.....	70
8.	Revision history	70

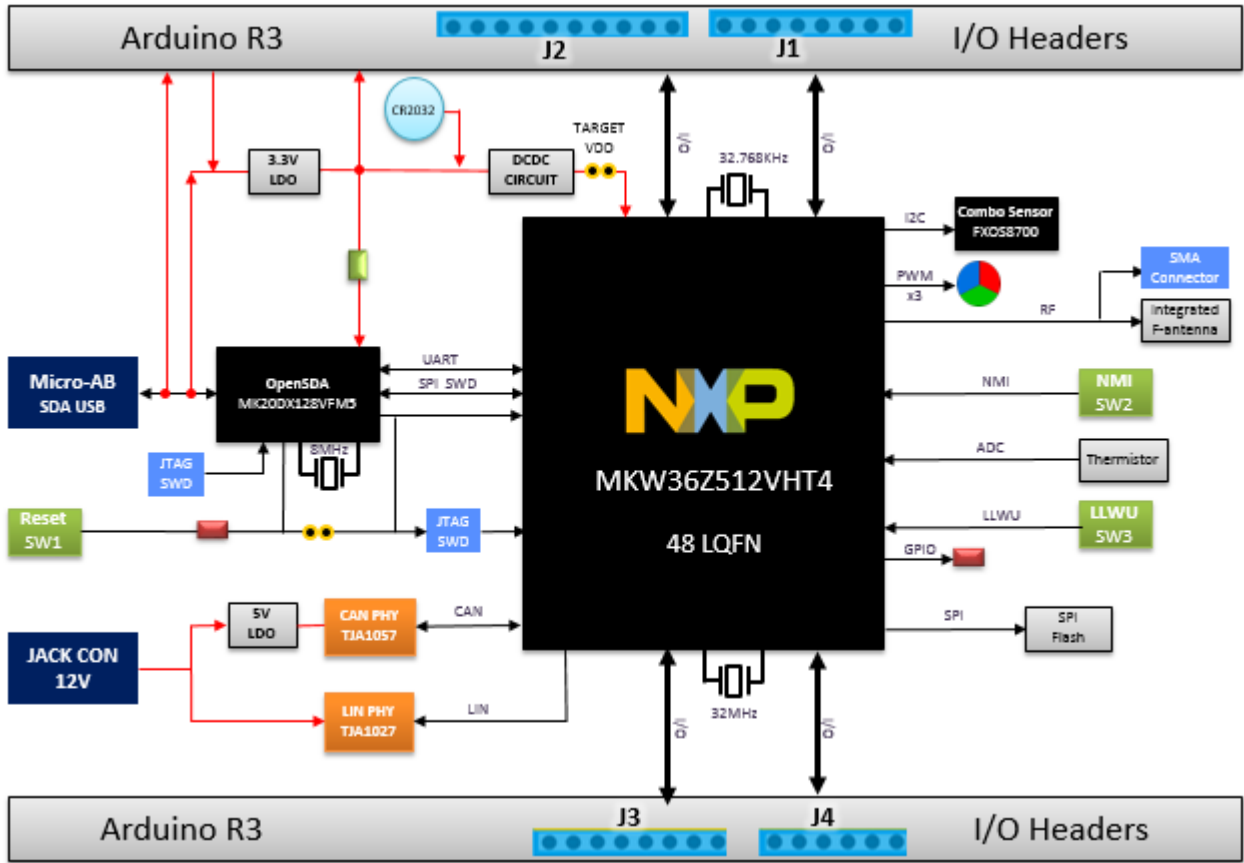

Figure 1. FRDM-KW36Z block diagram

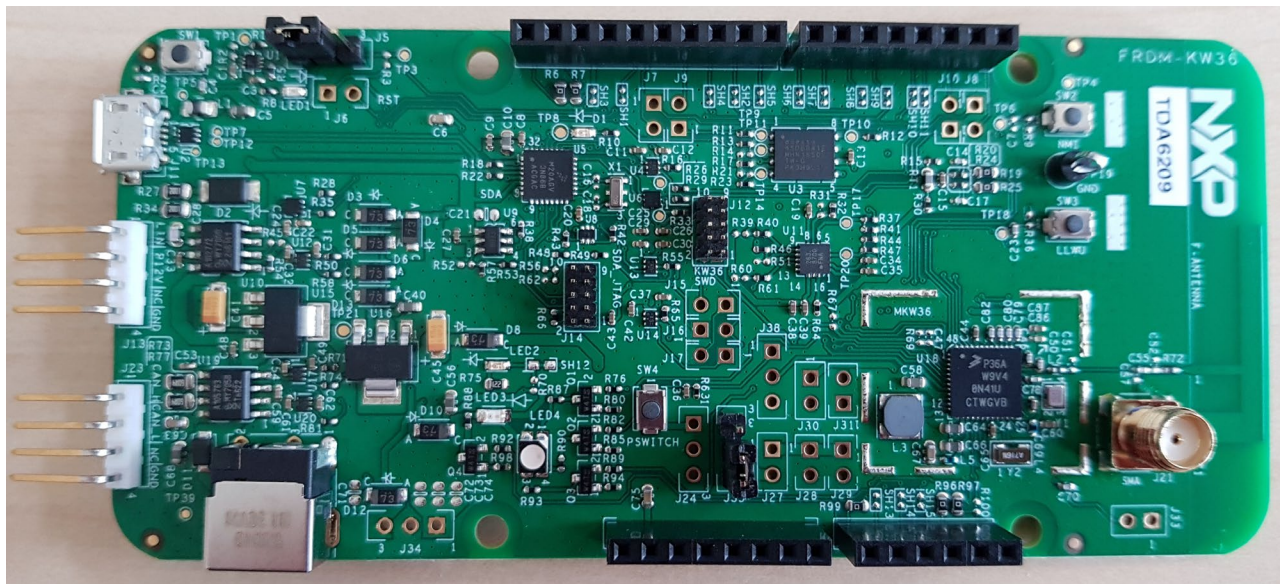

Figure 2. Freedom development kit for Kinetis/FRDM-KW36Z

1.1. List of tests

- Conducted tests
 - TX tests
 - Bench setup
 - Frequency accuracy
 - Phase noise
 - TX power
 - TX power in band
 - TX spurious (H2 to H10, ETSI, and FCC)
 - Upper band edge
 - Modulation characteristics
 - Carrier frequency offset and drift
 - RX tests
 - Bench setup
 - Sensitivity
 - Receiver maximum input level
 - RX spurious (from 30 MHz to 12.5 GHz)
 - Receiver interference rejection performances
 - C/I and receiver selectivity performances
 - Receiver blocking
 - Blocking interferers
 - Intermodulation
 - Return loss (S11)
 - RX
 - TX

1.2. Software

Before the measurements, a binary code (connectivity software) must be loaded into the board's flash memory.

The [KW35Z/36Z: Kinetis® KW35Z/36Z-Bluetooth®5 Wireless MCUs based on Arm Cortex-M0+](#) web page describes how to use the FRDM-KW36Z to load the code. The binary codes used for the following tests are the connectivity software package GenFSK protocol (2FSK modulation) and the HCI_blackbox. The TeraTerm terminal emulator is used to communicate with the KW36Z MCU.

1.3. List of equipment

This equipment is used to perform the RX and TX measurements:

- Spectrum Analyzer (25 GHz for harmonic measurements up to H10)
- R&S SFU (used as an interferer source for Bluetooth LE 4.2 - could be any generator with ARB)
- R&S CMW270 (HCI software)
- MXG (Agilent N5182A)
- Agilent SML03
- Agilent 33250A
- R&S ZND Vector Network Analyzer (for S11 measurements)
- RF Shielded box (to avoid interferers) and RF horn (for radiated measurements)
- Power supply
- PC equipped with a GPIB card

2. Tests summary

RF PHY Bluetooth Test Specification: RF-PHY.TS.4.2.0 (2014-12-09).

The list of measurements is provided in [Table 1](#) (for Bluetooth LE 4.2 standard), [Table 2](#) (for Europe), and [Table 3](#) (for US).

Table 1. List of tests (Bluetooth LE standard)

		Bluetooth LE 4.2 standard		
		reference	limit	
Transmission	TX Maximum Power	Bluetooth LE 4.2, BV-01-C	$-20 \text{ dBm} \leq \text{PAVG} \leq +10 \text{ dBm EIRP}$	PASS
	Tx power In Band	Bluetooth LE 4.2, BV-03-C	$P_{\text{TX}} \leq -20 \text{ dBm}$ for $(f_{\text{TX}} \pm 2 \text{ MHz})$	PASS
			$P_{\text{TX}} \leq -30 \text{ dBm}$ for $(f_{\text{TX}} \pm [3 + n] \text{ MHz})$;	
	Modulation characteristics	Bluetooth LE 4.2, BV-05-C	$225 \text{ kHz} \leq \Delta f_{\text{avg}} \leq 275 \text{ kHz}$	PASS
Carrier frequency offset and drift	Bluetooth LE 4.2, BV-06-C	$f_{\text{TX}} - 150 \text{ kHz} \leq f_n \leq f_{\text{TX}} + 150 \text{ kHz}$ where f_{TX} is the nominal transmit frequency and $n=0,1,2,3\dots k$ $ f_0 - f_n \leq 50 \text{ kHz}$ where $n=2,3,4\dots k$	PASS	
Reception	RX Sensitivity	Bluetooth LE 4.2, BV-01-C	PER 30.8% with a minimum of 1500 packets	PASS
	Co-channel	Bluetooth LE 4.2, BV-03-C	$> 21 \text{ dB}$	PASS
	Adjacent channel interference rejection (N \pm 1,2,3MHz)	Bluetooth LE 4.2, BV-03-C	$> 15 \text{ dB}, -17 \text{ dB}, -27 \text{ dB}$	PASS
	Blocking Interferers	Bluetooth LE 4.2, BV-04-C	$-30 \text{ dBm} / -35 \text{ dBm}$	PASS
	Intermodulation Performance	Bluetooth LE 4.2, BV-05-C	PER 30.8% with a minimum of 1500 packets	PASS
	Rx Maximum input level	Bluetooth LE 4.2, BV-06-C	PER 30.8% with a minimum of 1500 packets	PASS

Table 2. List of tests (ETSI Europe)

		EUROPE		
		<i>reference</i>	<i>limit</i>	
Transmission	Spurious 30 MHz - 1GHz	ETSI EN 300 328	-36 dBm or -54 dBm (depends on frequency) (100KHz BW)	PASS
	Spurious 1 GHz - 25 GHz	ETSI EN 300 328	-30 dBm (1MHz BW)	PASS
	Eirp Tx spectral density	ETSI EN 300 328	10dBm/MHz	PASS
	Phase noise (unspread)	NA	NA	For information
Reception	RX emissions 30 MHz - 1GHz	ETSI EN 300 328	-57 dBm (100 KHz)	PASS
	RX emissions 1GHz - 12.5 GHz	ETSI EN 300 328	-47 dBm (1MHz)	PASS
Misc.	Return loss (S11)	Return loss in Tx mode	For information	
		Return loss in Rx mode	For information	

Table 3. List of tests (FCC USA)

		US		
		<i>reference</i>	<i>limit</i>	<i>Status</i>
Transmission	TX Maximum Pow	FCC part15.247	PAVG ≤ 100mW +20 dBm EIRP	PASS
	Spurious 1GHz - 12.5 GHz	FCC part15.249	field strength < 50mV/m @3m -41.12 dBm (1MHz BW)	PASS

3. Conducted tests

3.1. TX tests

3.1.1. Test setup

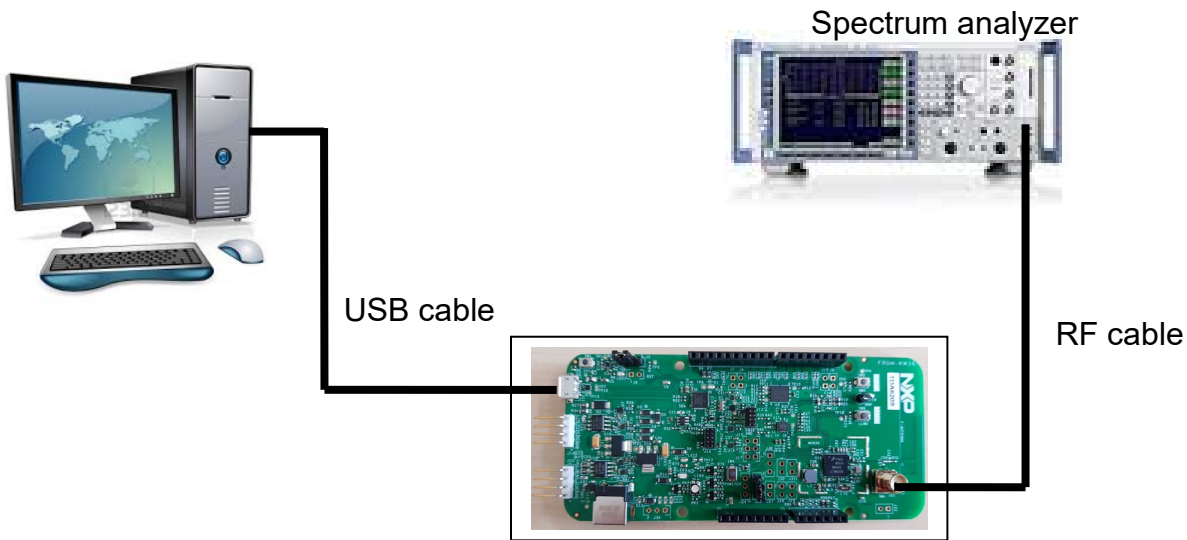

Figure 3. Conducted TX test setup

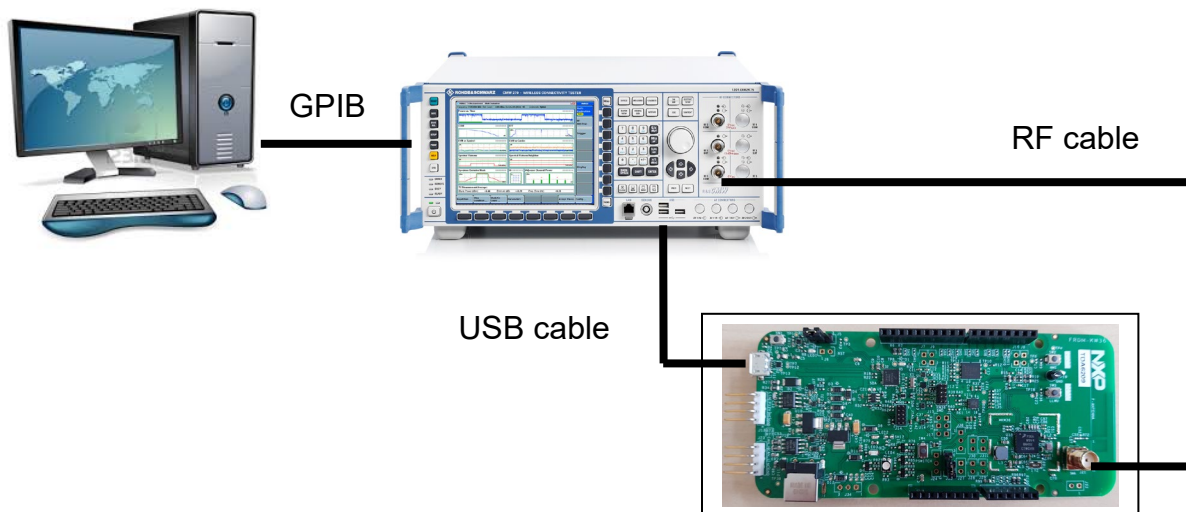

Figure 4. Specific conducted TX test setup

3.1.2. Frequency accuracy

Test method:

- Set the radio to:
 - TX mode, CW, continuous mode, frequency: channel 19
- Set the analyzer to:
 - Center frequency = 2.44 GHz, span = 1 MHz, Ref amp = 20 dBm, RBW = 10 kHz, VBW = 100 kHz
- Measure the CW frequency with the marker of the spectrum analyzer

Result:

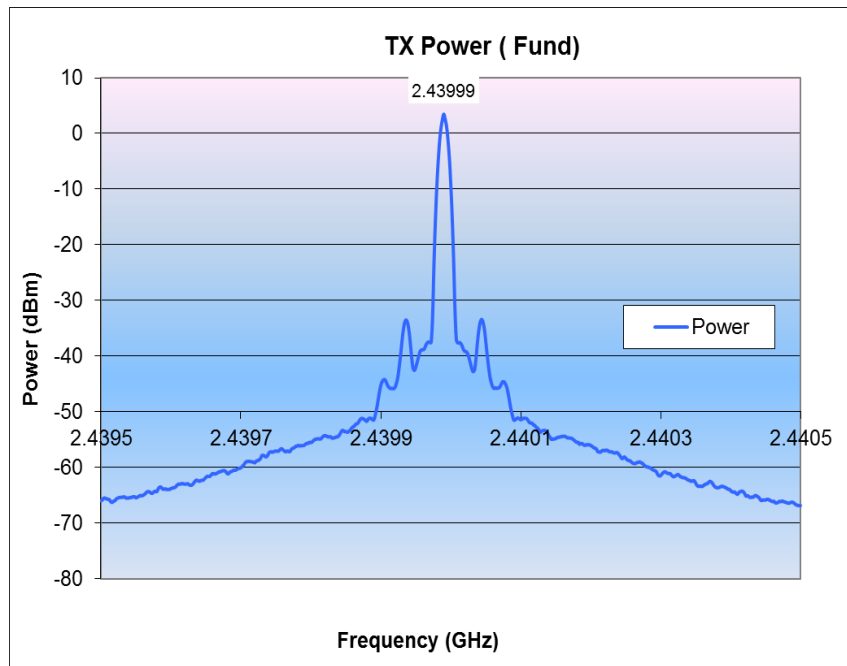

Figure 5. Frequency accuracy

- Measured frequency: 2.43999 GHz
- ppm value = $(2439990 - 2440000) / 2.44 = -4.1$ ppm

Table 4. Frequency accuracy

Result	Target
-4.1 ppm	+/-25 ppm

NOTE

The frequency accuracy depends on the XTAL model. The model used on the FRDM-KW36Z is Q22FA12800092 (EPSON®).

Conclusion:

- The frequency accuracy complies to the datasheet

3.1.3. Phase noise

Test method:

- Set the radio to:
 - TX mode, CW, continuous mode, frequency: channel 19
- Set the analyzer to:
 - Center frequency = 2.44 GHz, span = 1 MHz, Ref amp = 20 dBm, RBW = 10 kHz, VBW = 100 kHz
- Measure the phase noise at the 100 kHz offset frequency
 - RBW (spectrum analyzer) = 10 kHz ($20 \log(10 \text{ kHz}) = 40 \text{ dBc}$)

Result:

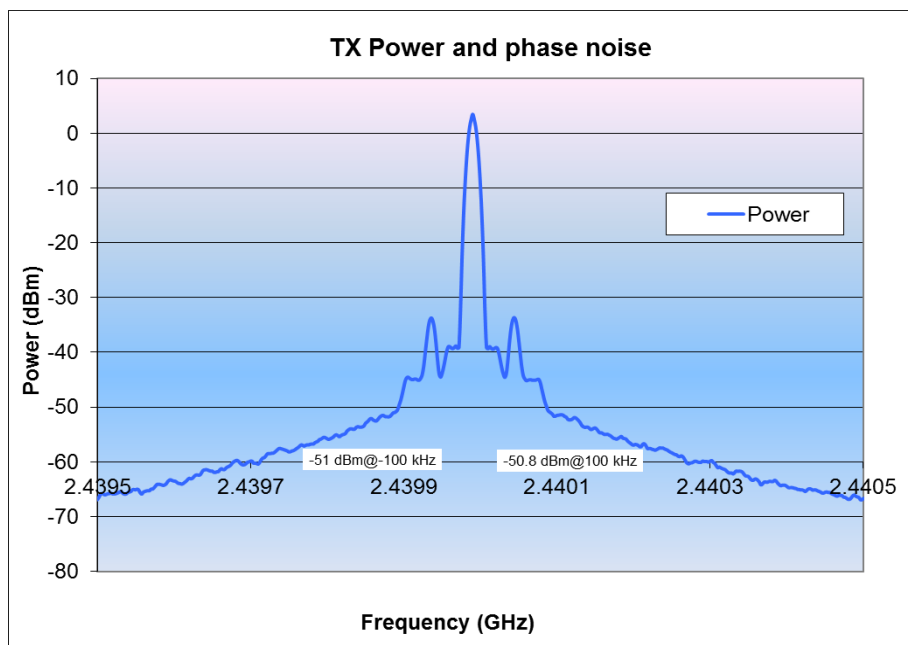

Figure 6. Conducted phase noise

- Marker value (delta) = $-50.8 \text{ dBm} / 100 \text{ kHz} = -94.4 \text{ dBc/Hz}$

NOTE

The phase noise value is for informational purposes only. No specific issue on this parameter.

3.1.4. +3.5 dBm TX power (fundamental)

Test method:

- Set the radio to:
 - TX mode, modulated, continuous mode
- Set the analyzer to:
 - Start freq = 2.4 GHz, Stop freq = 2.5 GHz, Ref amp = 10 dBm, sweep time = 100 ms, RBW = 3 MHz, VBW = 3 MHz
 - Max hold mode
 - Detector = RMS
- Sweep all the channels from channel 0 to channel 39

The software tool allows sweeping from 2.36 GHz to 4.88 GHz.

Result:

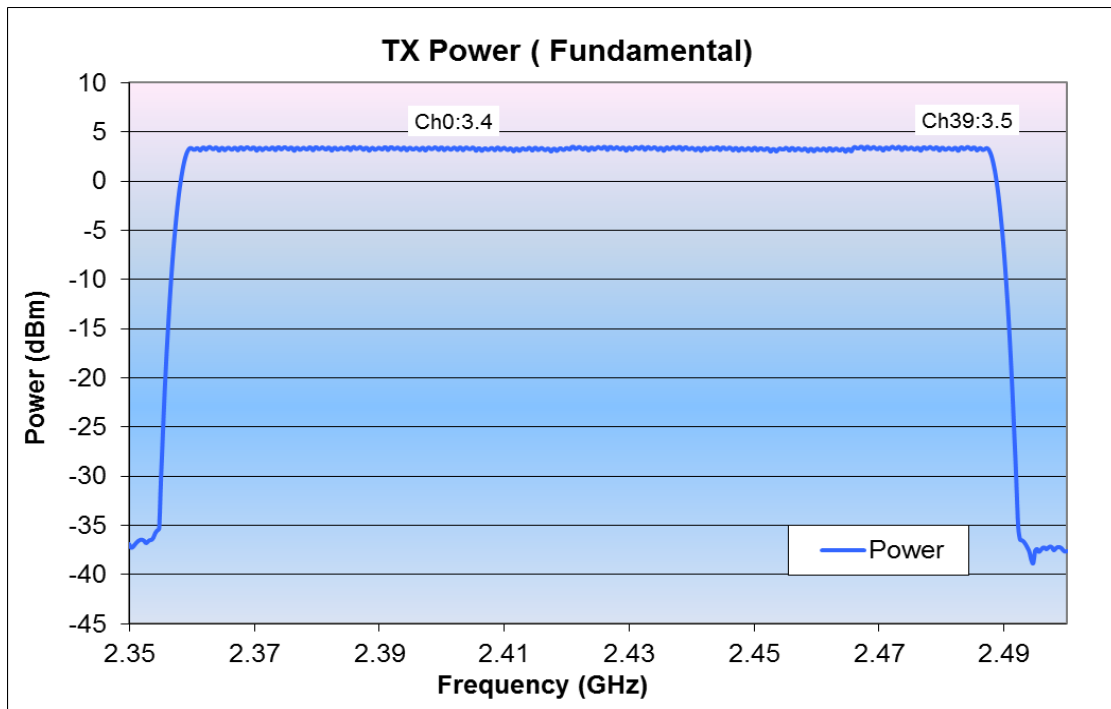

Figure 7. TX power

- Maximum power is on channel 39: +3.5 dBm
- Minimum power is on channel 0: +3.4 dBm
- Tilt over frequencies is 0.1 dB

Conclusion:

- The default TX power is in line with the expected results
- The power is flat over frequencies

3.1.5. +5 dBm TX power (fundamental)

Test method:

- Set the radio to:
 - TX mode, modulated, continuous mode
- Set the analyzer to:
 - Start freq = 2.4 GHz, Stop freq = 2.5 GHz, Ref amp = 10 dBm, sweep time = 100 ms, RBW = 3 MHz, VBW = 3 MHz
 - Max Hold mode
 - Detector = RMS
- Sweep all the channels from channel 0 to channel 39. Software tool allows sweeping from 2.36 GHz to 4.88 GHz.

Result:

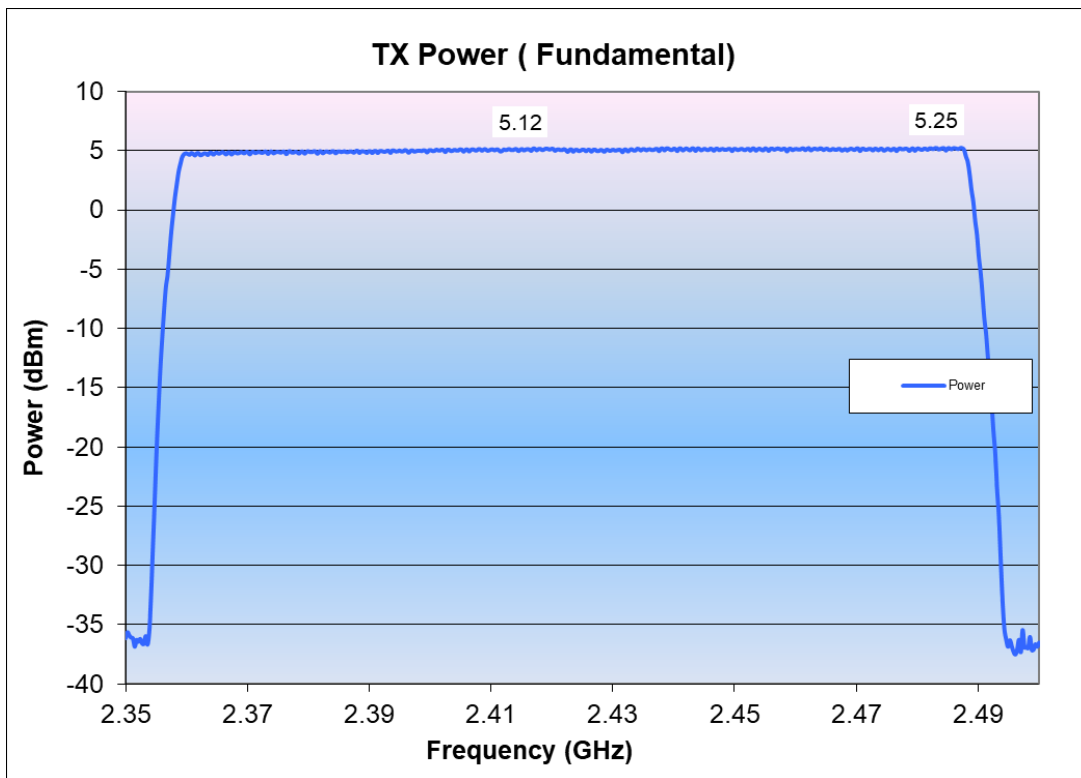

Figure 8. TX power

- Maximum power is on channel 39: 3.5 dBm
- Minimum power is on channel 0: 3.4 dBm
- Tilt over frequencies is: 0.1 dB

Conclusion:

- The default TX power is in line with the expected results
- The power is flat over frequencies

3.1.6. TX power in band

Test method:

- Set the radio to:
 - TX mode, modulated, continuous mode
- Set the analyzer to:
 - Start freq = 2.35 GHz, Stop freq = 2.5 GHz, Ref amp = 10 dBm, sweep time = 100 ms, RBW = 100 kHz, Video BW = 300 kHz
 - Max hold mode
 - Detector = RMS
 - Number of sweeps = 10
- Sweep on channel 2, channel 19, and channel 37

Result:

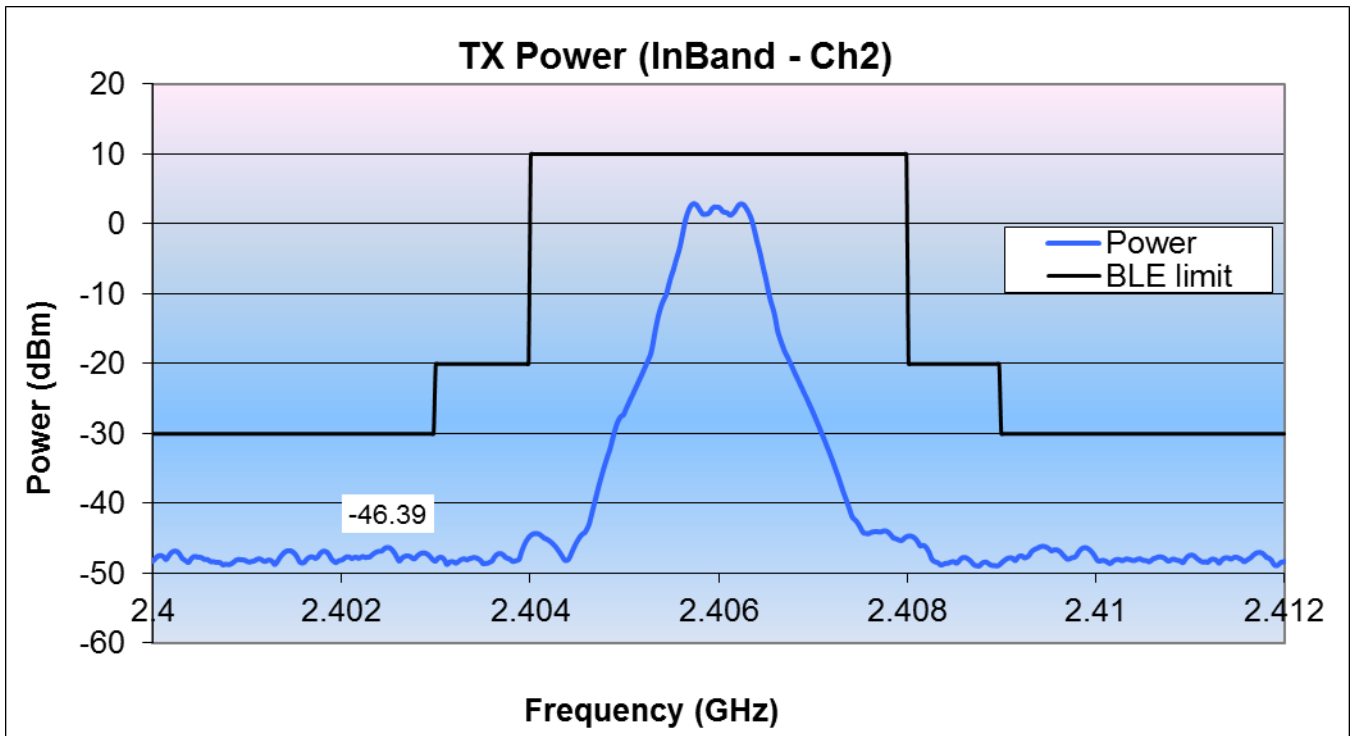

Figure 9. TX power in band (channel 2)

Table 5. TX power in band (channel 2)

Max peak level <=-2 MHz	-45.0	dBm	@	2.404	GHz
Max peak level >=+2 MHz	-44.7	dBm	@	2.408	GHz
Max peak level <=-3 MHz	-46.4	dBm	@	2.403	GHz
Max peak level >=+3 MHz	-46.2	dBm	@	2.409	GHz

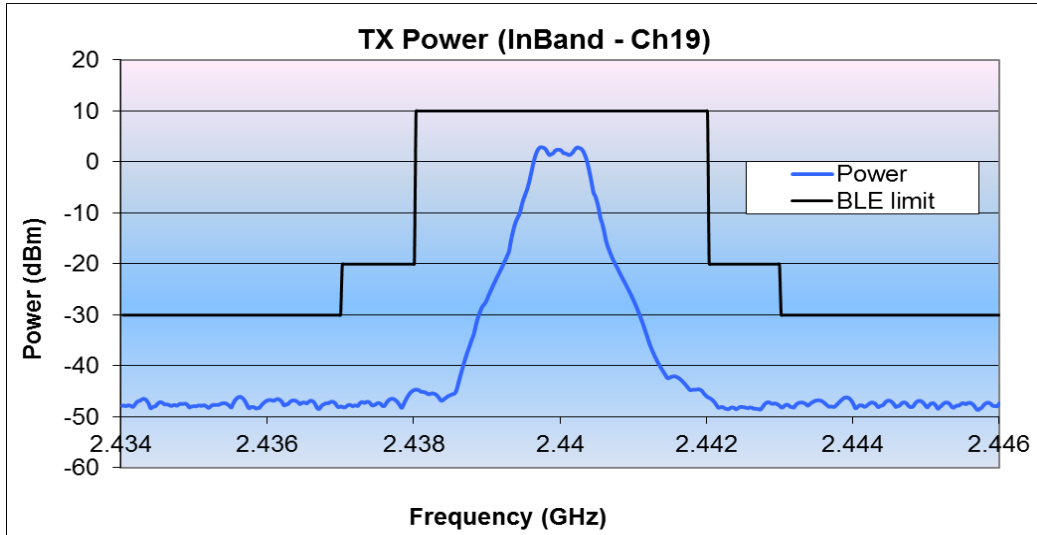

Figure 10. TX power in band (channel 19)

Table 6. TX power in band (channel 19)

Max peak level <=-2 MHz	-44.7	dBm	@	2.438	GHz
Max peak level >=+2 MHz	-46.3	dBm	@	2.442	GHz
Max peak level <=-3 MHz	-46.1	dBm	@	2.437	GHz
Max peak level >=+3 MHz	-46.2	dBm	@	2.443	GHz

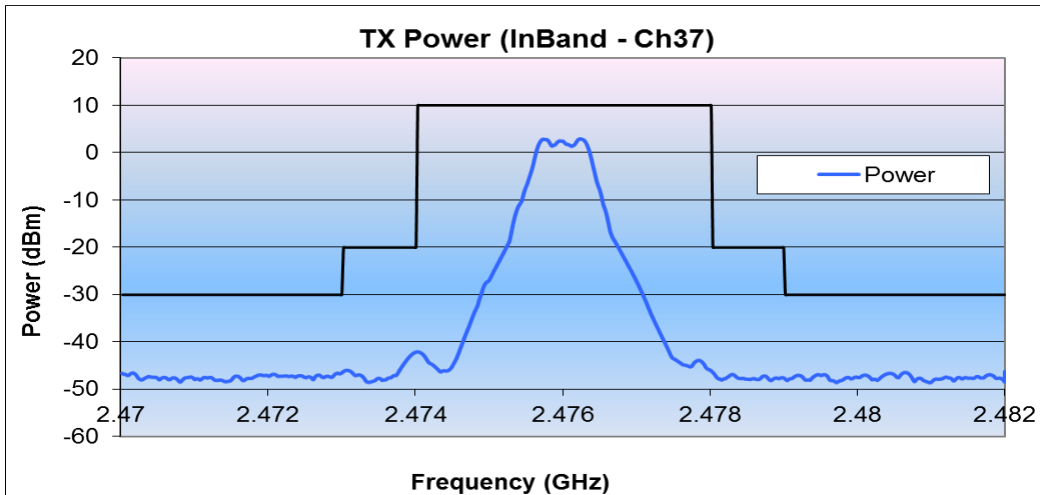

Figure 11. TX power in band (channel 37)

Table 7. TX power in band (channel 37)

Max peak level <=-2 MHz	-42.1	dBm	@	2.474	GHz
Max peak level >=+2 MHz	-46.4	dBm	@	2.478	GHz
Max peak level <=-3 MHz	-46.5	dBm	@	2.473	GHz
Max peak level >=+3 MHz	-46.2	dBm	@	2.479	GHz

Conclusion:

- The results comply to Bluetooth LE 4.2

3.1.7. TX spurious @ +3.5 dBm

3.1.7.1. 30 MHz to 12.5 GHz

Spurious overview of the full band from 30 MHz to 12.5 GHz when the device is in the transmission mode.

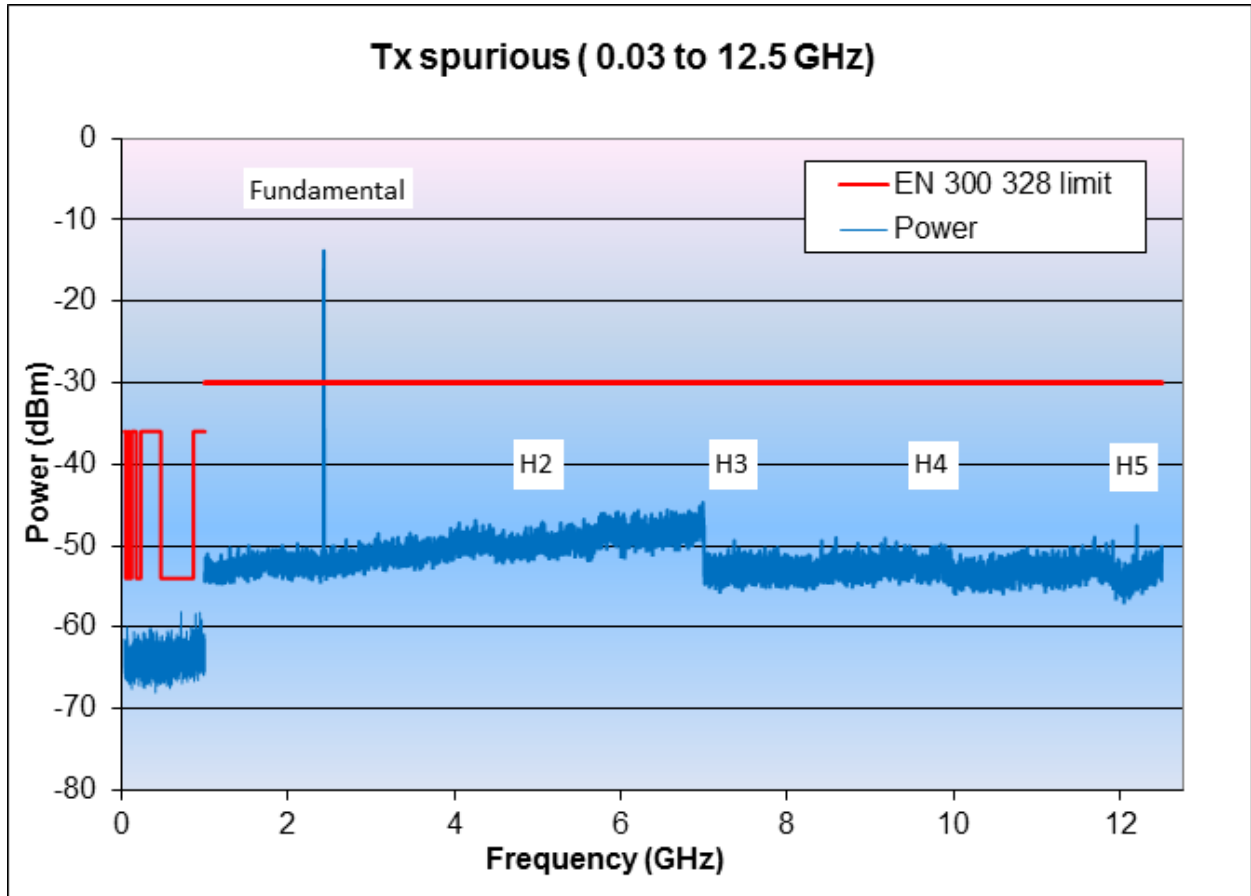

Figure 12. Conducted TX spurious (30 MHz to 1 GHz)

Conclusion:

- There are no TX spurs above the EN 300 328 limit (more than 15-dB margin)
- Harmonics are specifically measured in the following paragraphs

3.1.7.2. H2 @ +3.5 dBm (ETSI test conditions, peak measurement)

Test method:

- Set the radio to:
 - TX mode, modulated, continuous mode
- Set the analyzer to:
 - Start freq = 4.7 GHz, Stop freq = 5 GHz, Ref amp = -20 dBm, sweep time = 100 ms, RBW = 1 MHz, VBW = 3 MHz
 - Max hold mode
 - Detector: peak
- Sweep all the channels from channel 0 to channel 39

Result:

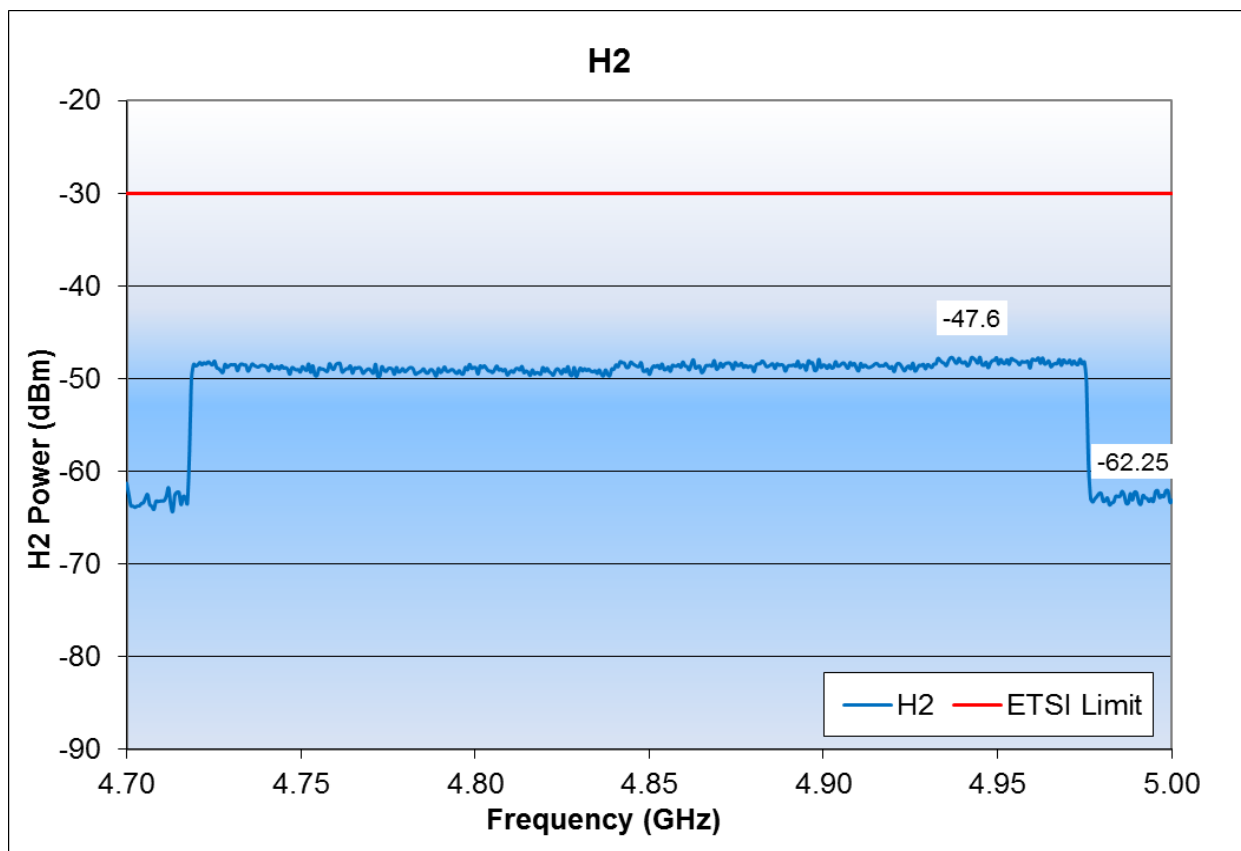

Figure 13. Conducted H2 spurious

- Maximum power is at channel 29: -47.6 dBm

Conclusion:

- There is 17.6 dB margin to the ETSI limit

3.1.7.3. H3 @ +3.5 dBm (ETSI test conditions, peak measurement)

The same method as the H2, except that the spectrum analyzer frequency start/stop is set to 7.0 and 7.5 GHz.

Result:

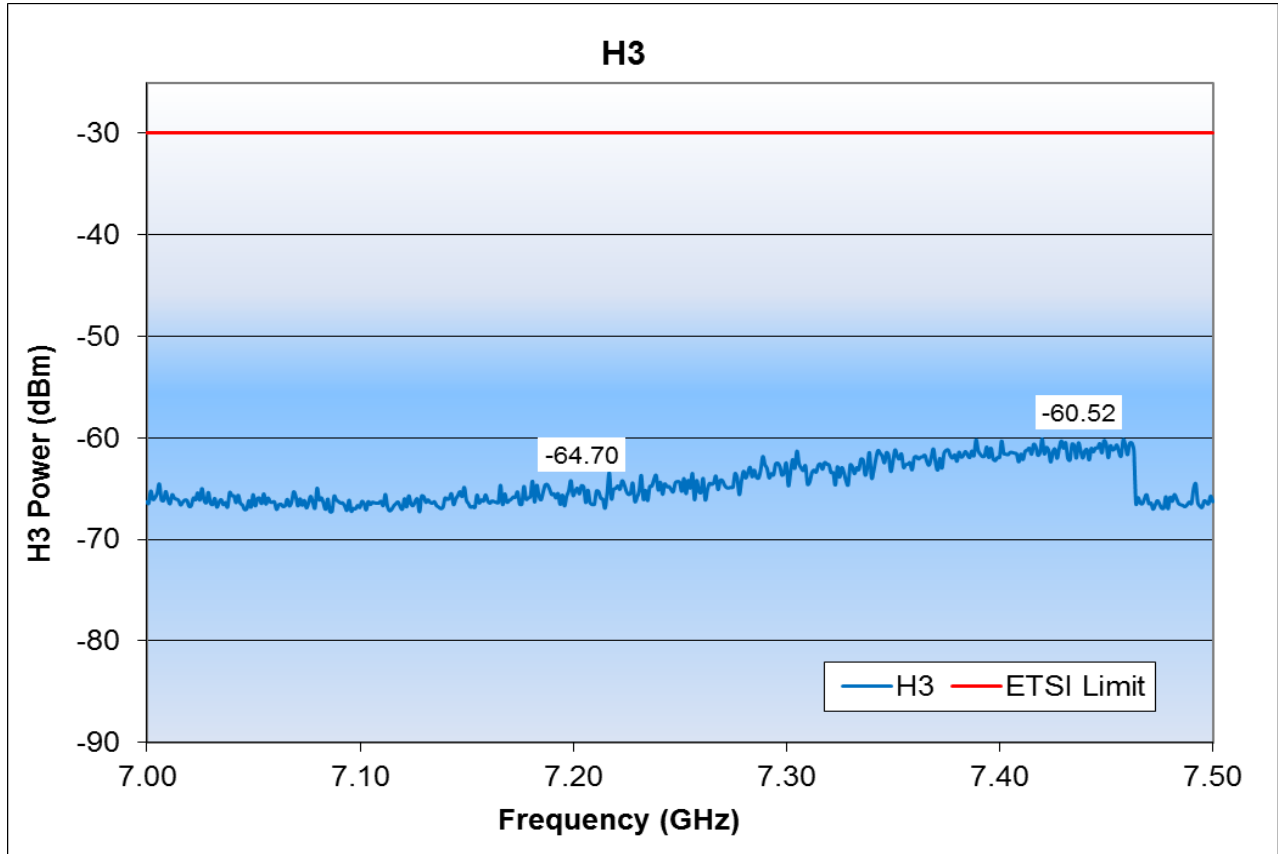

Figure 14. Conducted H3 spurious

- Maximum power is at channel 36: -60.5 dBm

Conclusion:

- There is 30.52 dB margin to the ETSI limit

3.1.7.4. H4 @ +3.5 dBm (ETSI test conditions, peak measurement)

Same method as the H2, except that the spectrum analyzer frequency span is set from 9.4 to 10.0 GHz.

Result:

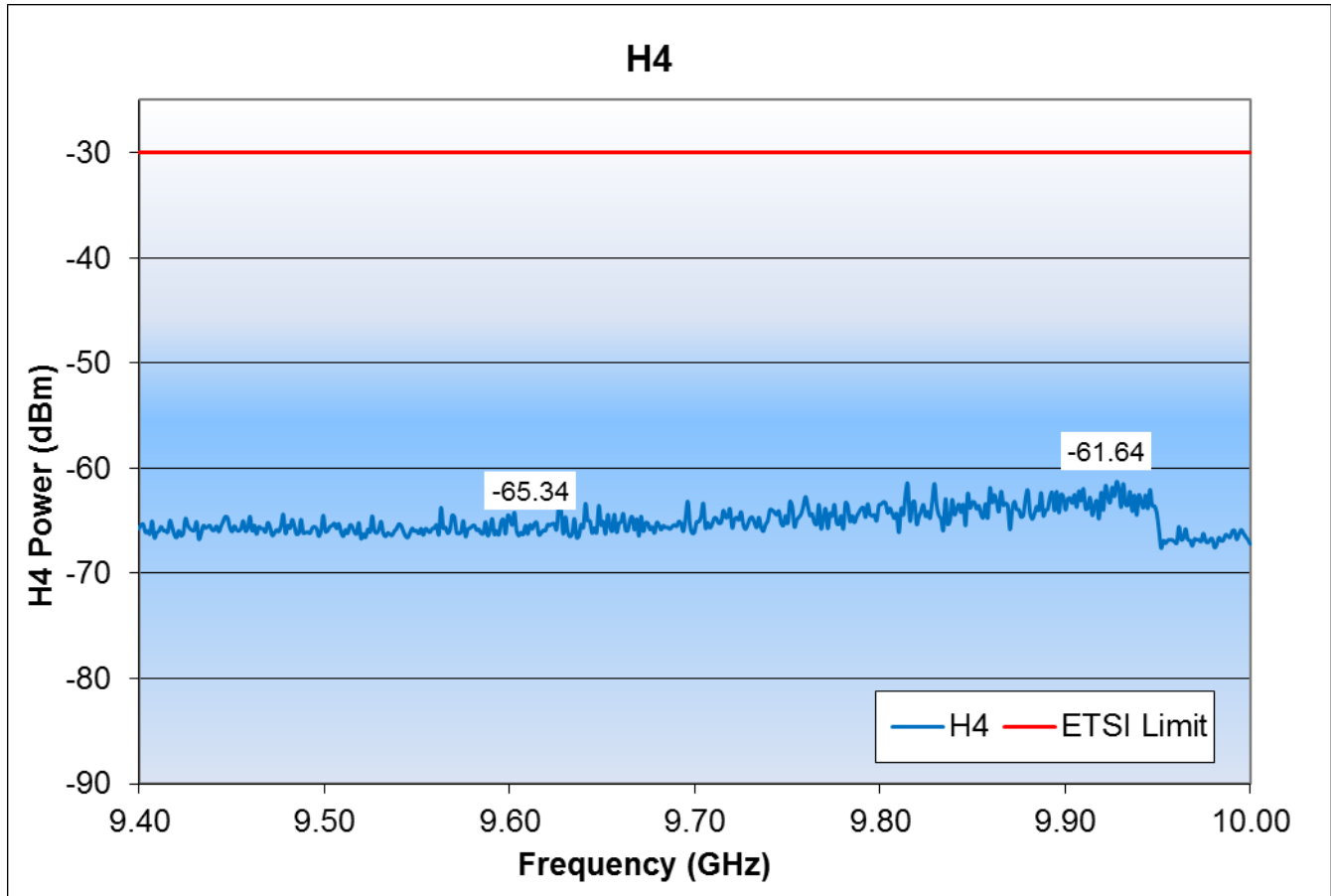

Figure 15. Conducted H4 spurious

- Maximum power is at channel 28: -61.6 dBm

Conclusion:

- There is 31.64 dB margin to the ETSI limit.

3.1.7.5. H5 @ +3.5 dBm (ETSI test conditions, peak measurement)

Same method as the H2, except that the spectrum analyzer frequency span is set from 11.7 to 12.5 GHz.

Result:

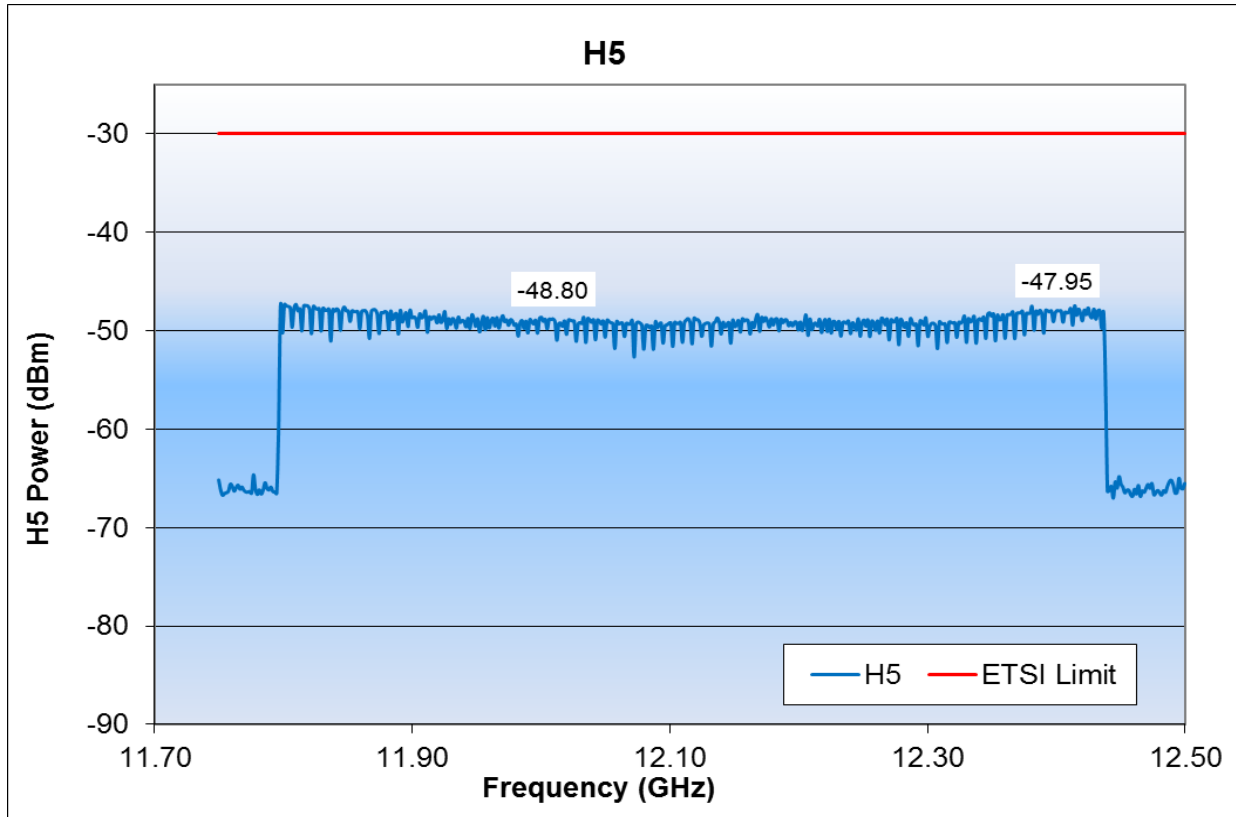

Figure 16. Conducted H5 spurious

- Maximum power is at channel 37: -47.09 dBm

Conclusion:

- There is 17.95 dB margin to the ETSI limit

3.1.7.6. H2 FCC @ +3.5 dBm (FCC test conditions, average measurements)

Test method:

- Set the radio to:
 - TX mode, modulated, continuous mode
- Set the analyzer to:
 - Start freq = 4.7 GHz, Stop freq = 5 GHz, Ref amp = -20 dBm, sweep time = 100 ms, RBW = 1 MHz, VBW = 3 MHz
 - Trace: max hold mode
 - Detector: RMS
- Sweep all the channels from channel 0 to channel 39

Result:

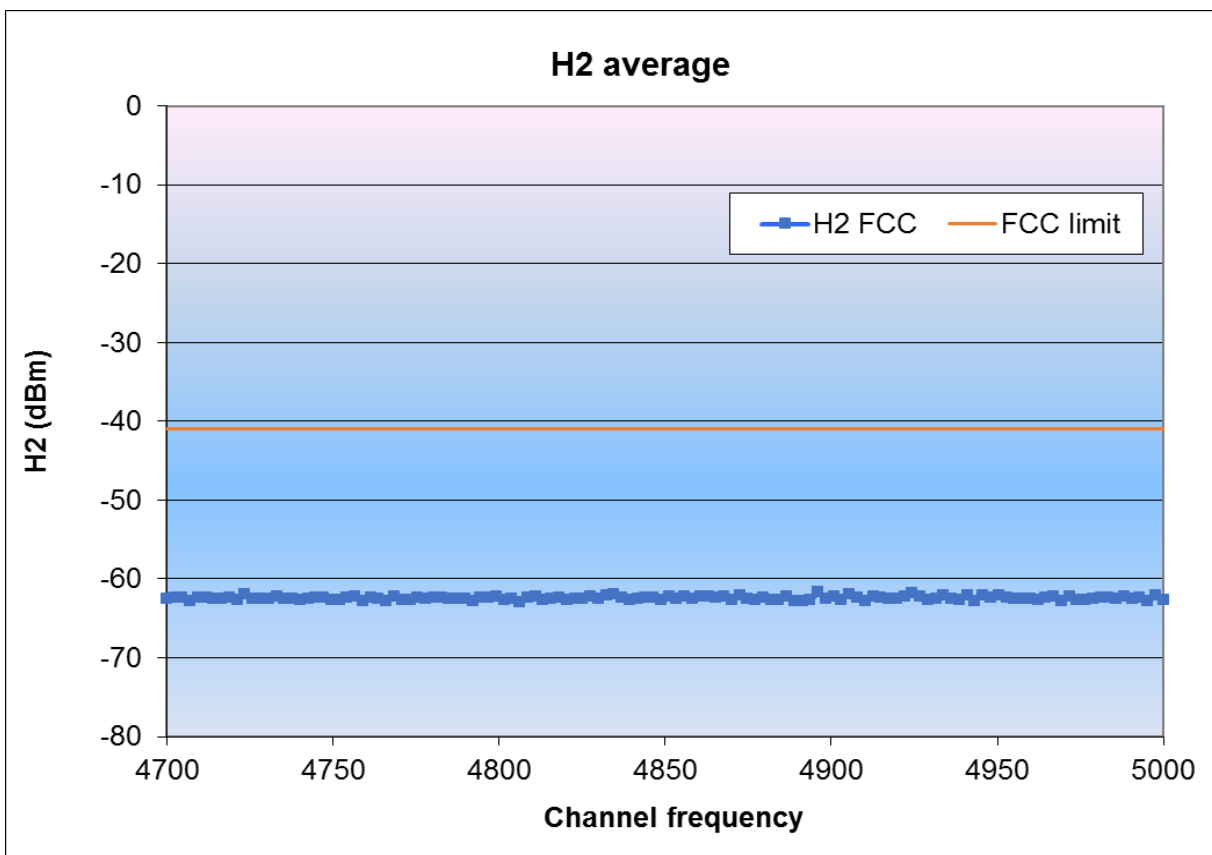

Figure 17. Conducted H2 FCC spurious

- Maximum power is at channel 23: -61.7 dBm

Conclusion:

- There is 20.6 dB margin to the FCC limit

3.1.7.7. H3 FCC @ +3.5 dBm (FCC test conditions, average measurements)

Same method as the H2, except that the spectrum analyzer frequency span is set from 7.0 to 7.5 GHz.

Result:

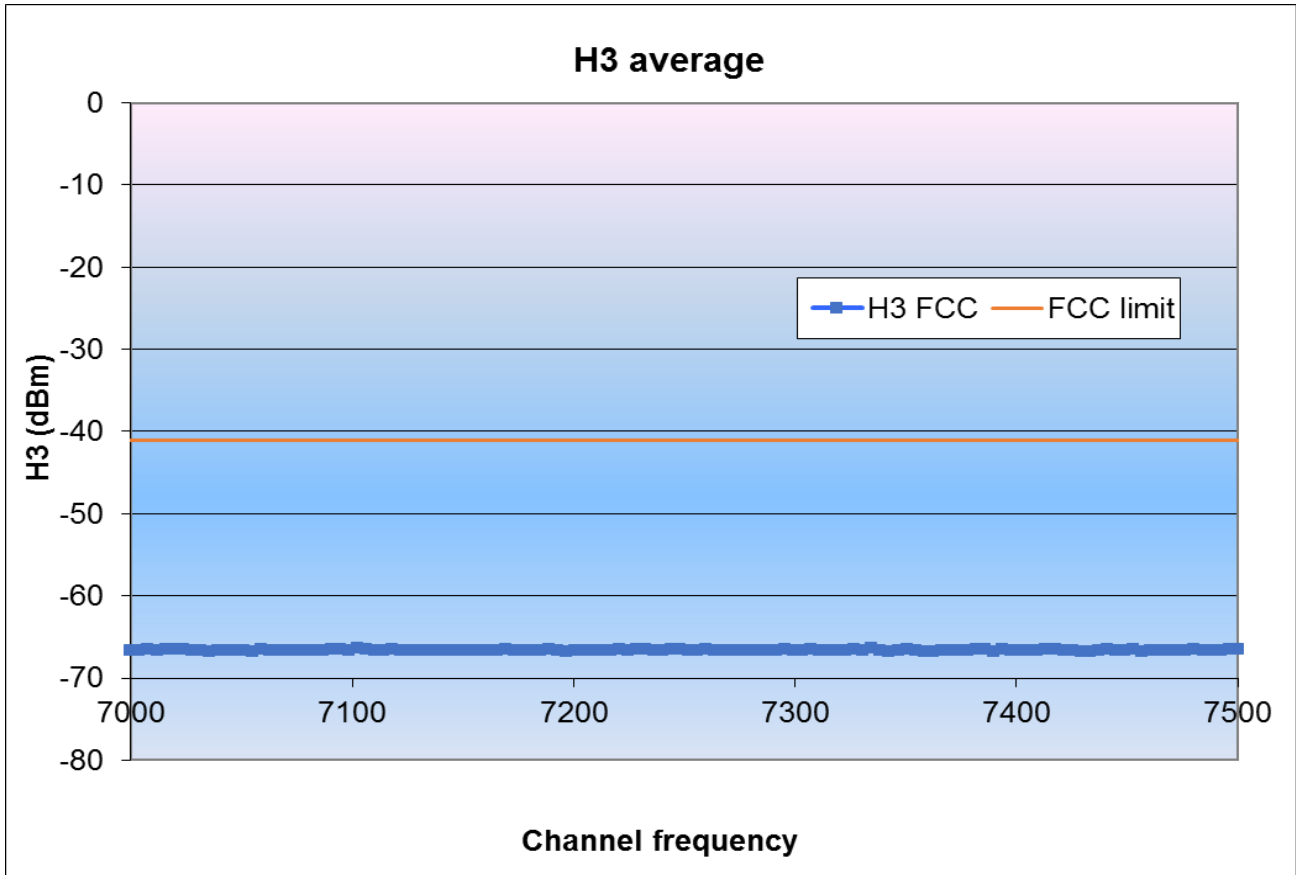

Figure 18. Conducted H3 FCC spurious

- Maximum power is at channel 21: -66.4 dBm

Conclusion:

- There is 25.28 dB margin to the FCC limit

3.1.7.8. H4 FCC @ +3.5 dBm (FCC test conditions, average measurements)

Same method as the H2, except that the spectrum analyzer frequency span is set from 9.4 to 10 GHz.

Result:

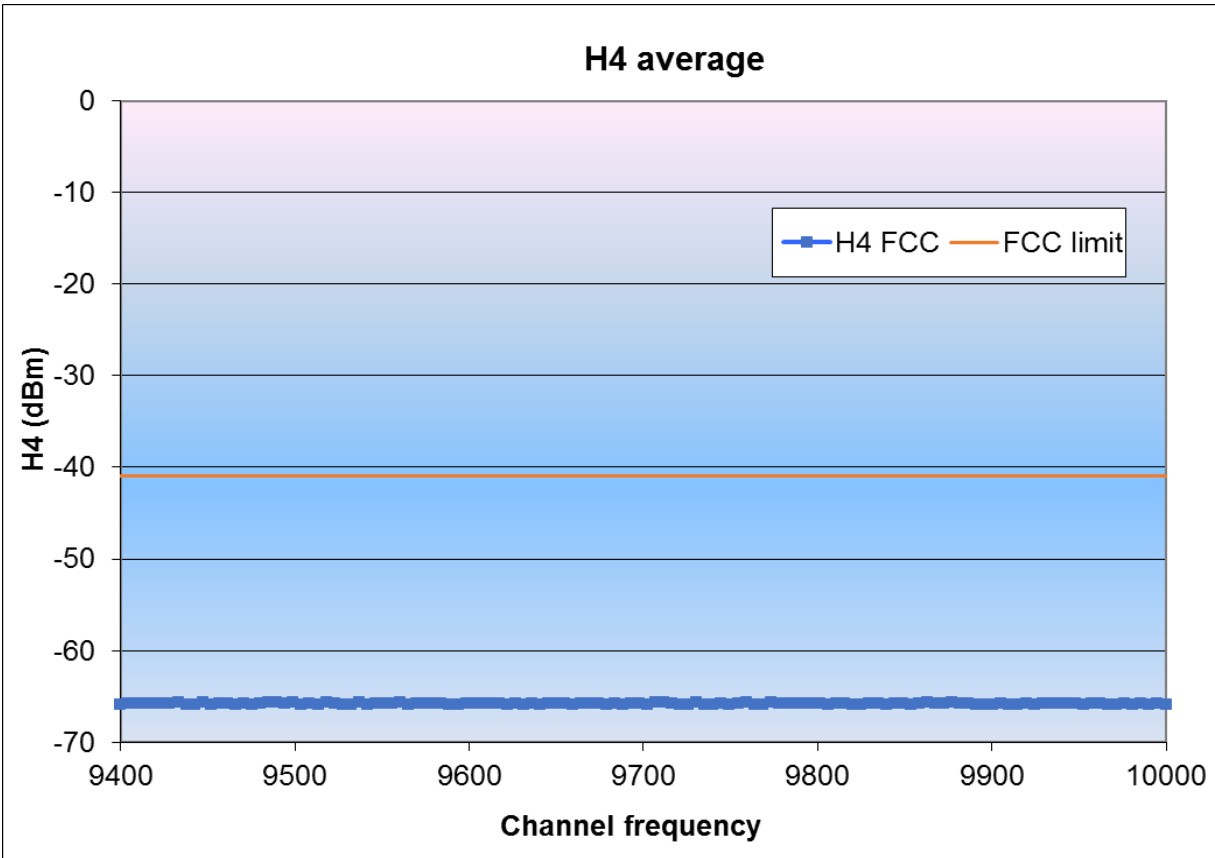

Figure 19. Conducted H4 FCC spurious

- Maximum power is at channel 32: -65.6 dBm

Conclusion:

- There is 24.48 dB margin to the FCC limit

3.1.7.9. H5 FCC @ +3.5 dBm (FCC test conditions, average measurements)

Same method as the H2, except that the spectrum analyzer frequency span is set from 11.7 to 12.5 GHz.

Result:

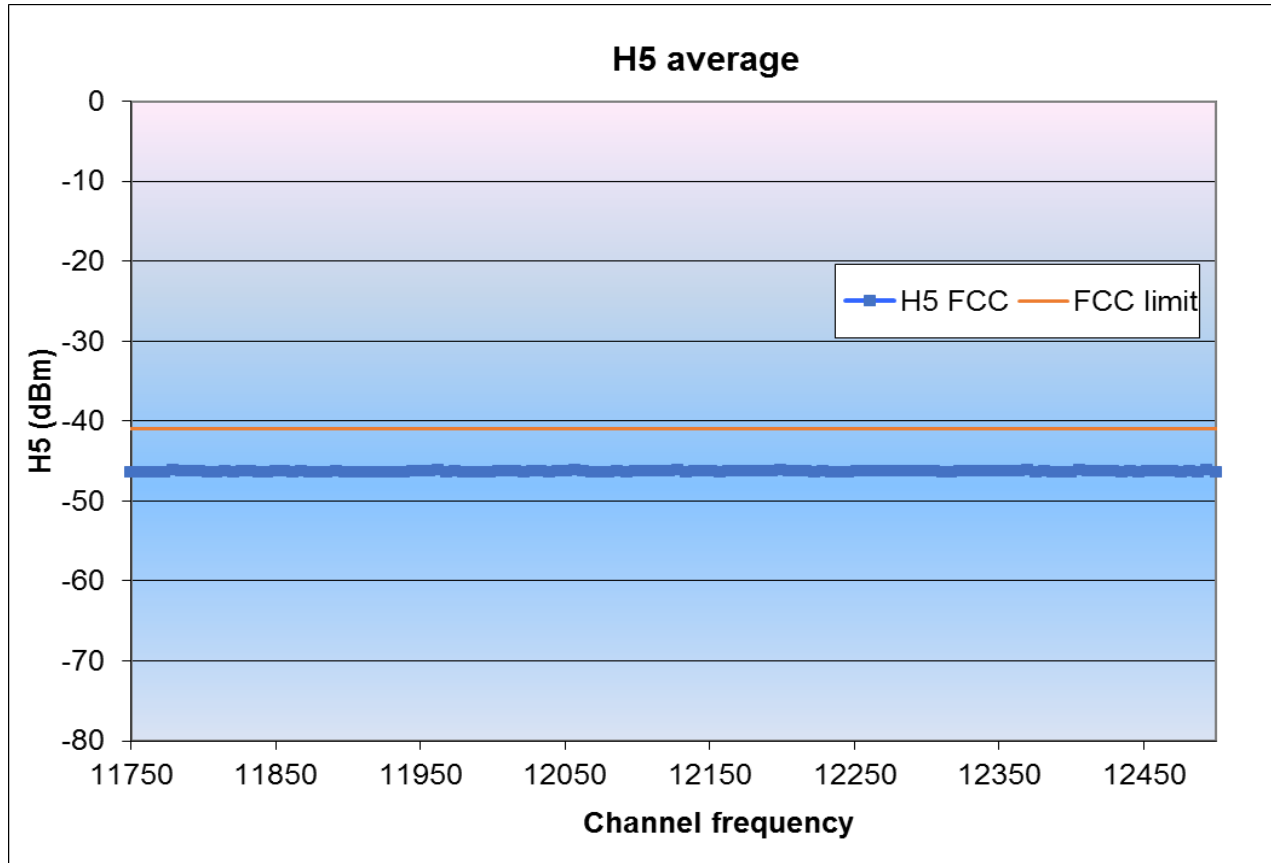

Figure 20. Conducted H5 FCC spurious

- Maximum power is at channel 39: -46.1 dBm

Conclusion:

- There is 4.98 dB margin to the FCC limit

3.1.8. TX spurious @ +5 dBm

3.1.8.1. 30 MHz to 12.5 GHz

Spurious overview of the full band from 30 MHz to 12.5 GHz when the device is in the transmission mode.

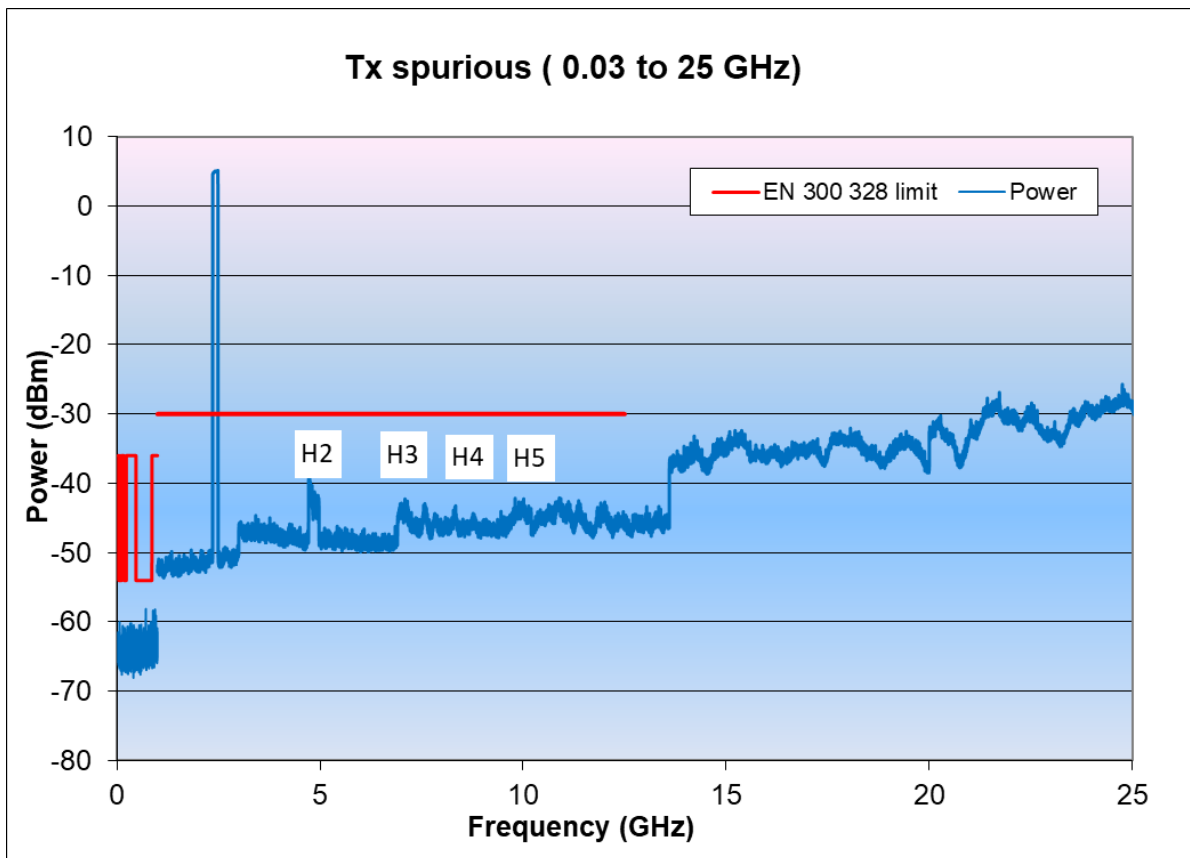

Figure 21. Conducted Tx spurious (30 MHz to 25 GHz)

Conclusion:

- There are no TX spurs above the EN 300 328 limit (more than 9-dB margin)
- Harmonics are specifically measured in the following paragraphs

3.1.8.2. H2 @ +5 dBm (ETSI test conditions, peak measurement)

Test method:

- Set the radio to:
 - Tx mode, modulated, continuous mode
- Set the analyzer to:
 - Start freq = 4.7 GHz, Stop freq = 5 GHz, Ref amp = -20 dBm, sweep time = 100 ms,
 - RBW = 1 MHz, VBW = 3 MHz
 - Max Hold mode
 - Detector: Peak
- Sweep all the channels from channel 0 to channel 39

Result:

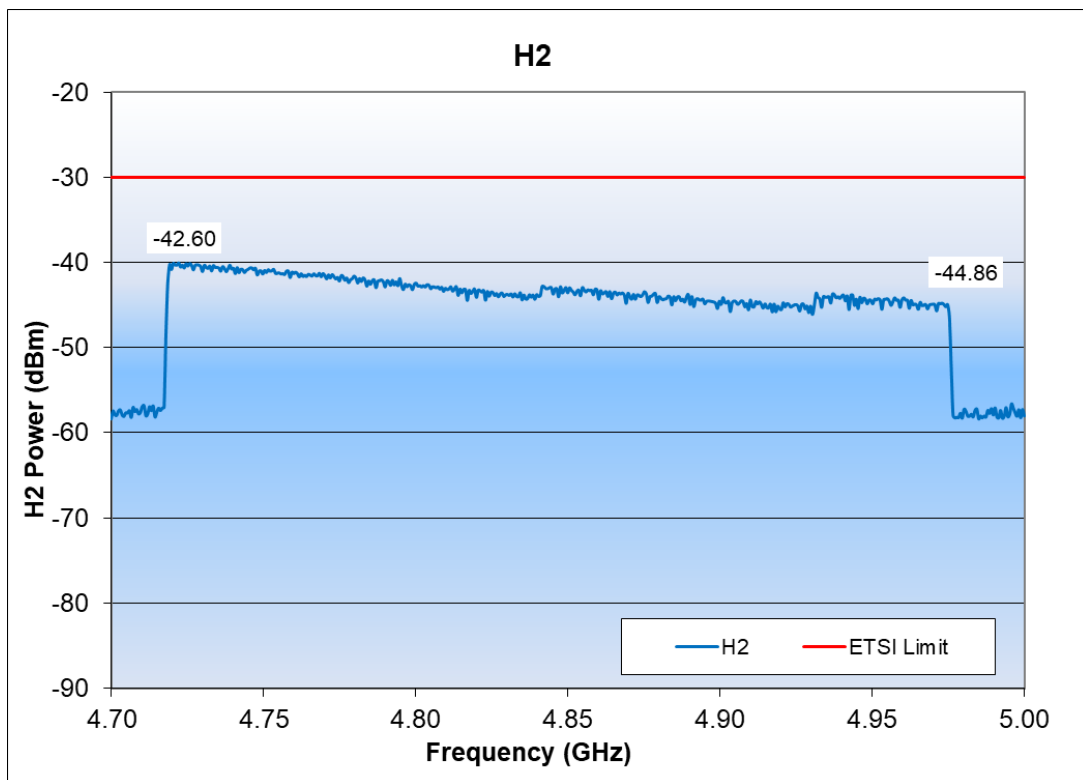

Figure 22. Conducted H2 spurious

- Maximum power is at frequency 4.8 GHz: -42.6 dBm

Conclusion:

- There is more than 12 dB margin to the ETSI limit

3.1.8.3. H3 @ +5 dBm (ETSI test conditions, peak measurement)

The same method as for H2, except that the spectrum analyzer frequency start/stop is set to 7.0 and 7.5 GHz.

Result:

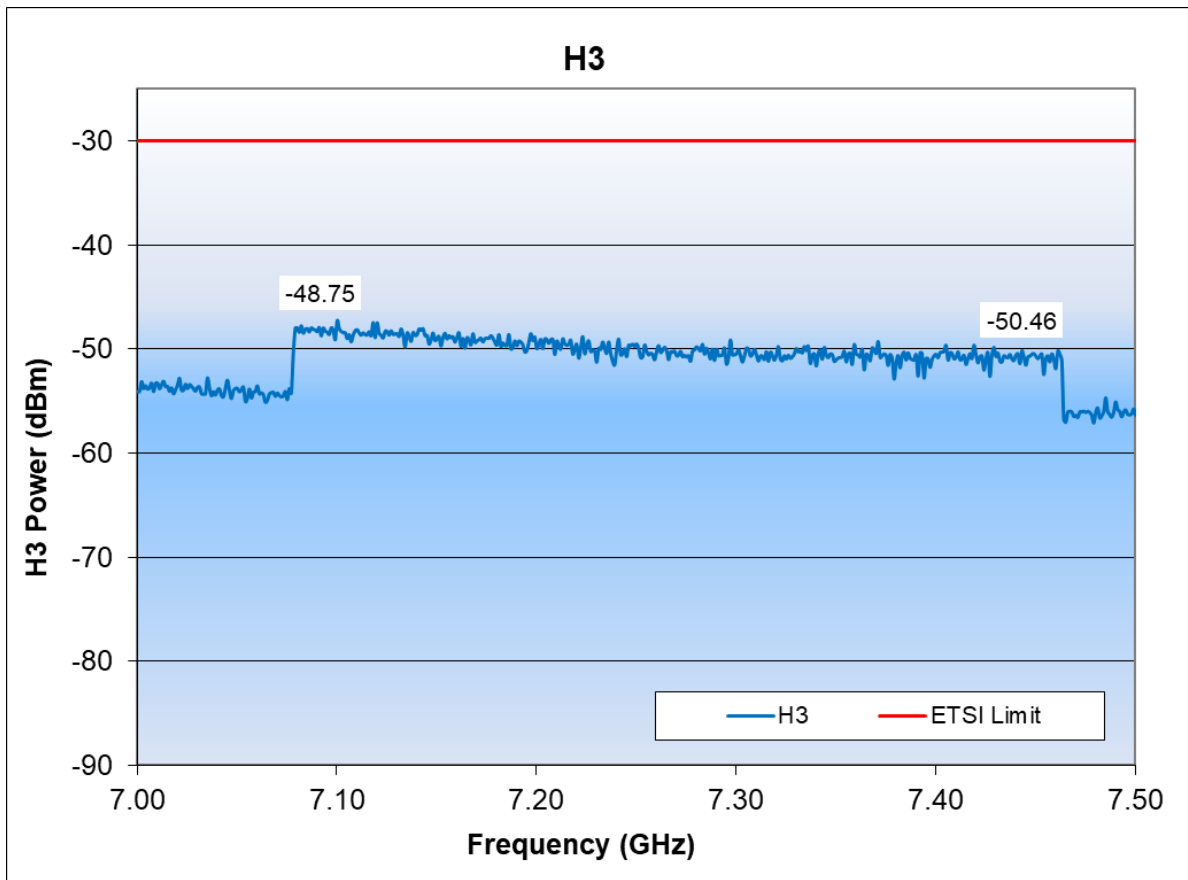

Figure 23. Conducted H3 spurious

- Maximum power is at frequency 7.22 GHz: -48.75 dBm

Conclusion:

- There is more than 18 dB margin to the ETSI limit

3.1.8.4. H4 @ +5 dBm (ETSI test conditions, peak measurement)

Same method as for H2, except that the spectrum analyzer frequency span is set from 9.4 to 10.0 GHz.

Result:

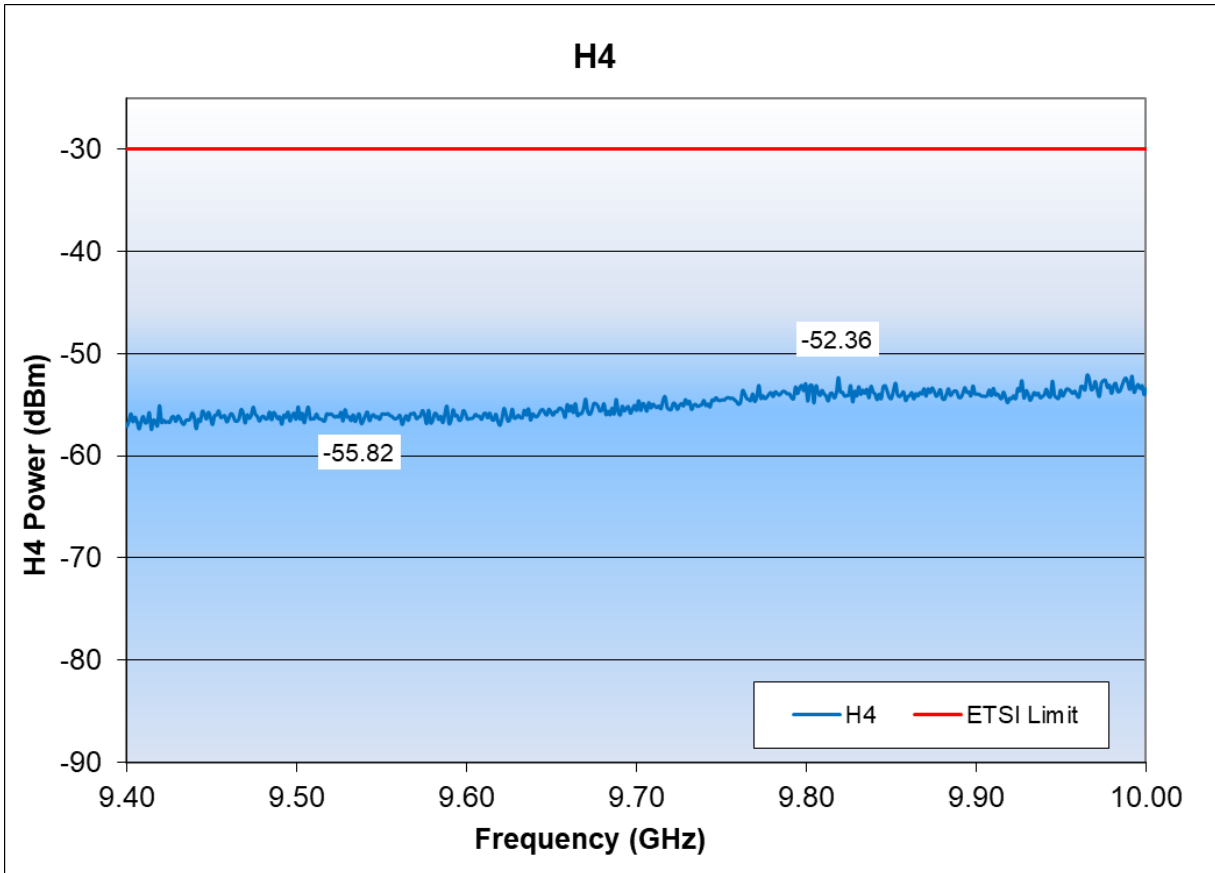

Figure 24. Conducted H4 spurious

- Maximum power is at frequency 9.82 GHz: -52.36 dBm

Conclusion:

- There is more than 22 dB margin to the ETSI limit

3.1.8.5. H5 @ +5 dBm (ETSI test conditions, peak measurement)

Same method as the H2, except that the spectrum analyzer frequency span is set from 11.7 GHz to 12.5 GHz.

Result:

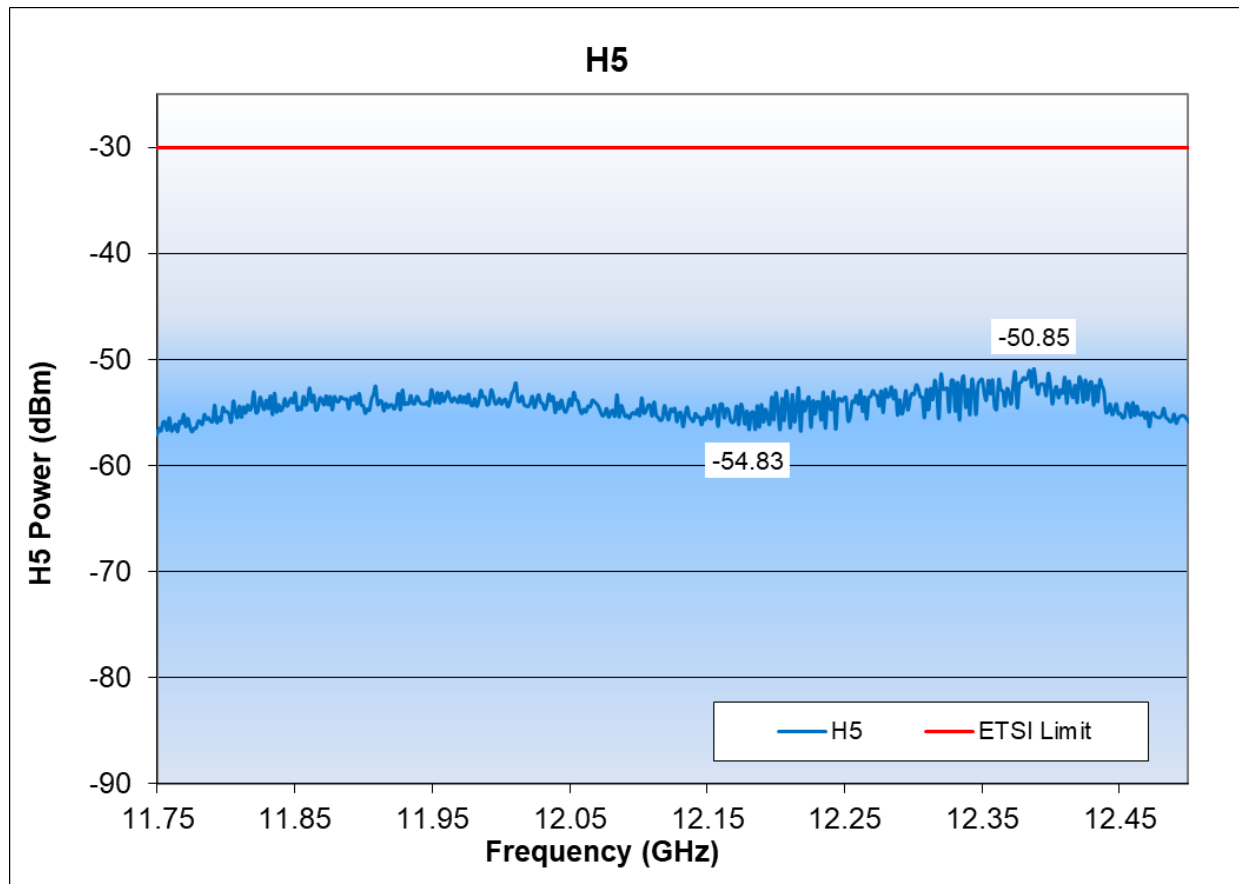

Figure 25. Conducted H5 spurious

- Maximum power is at frequency 12.38 GHz: -50.85 dBm

Conclusion:

- There is more than 20 dB margin to the ETSI limit

3.1.8.6. H6 @ +5 dBm (ETSI test conditions, peak measurement)

Same method as the H2, except that the spectrum analyzer frequency span is set from 14.1 GHz to 15 GHz.

Result:

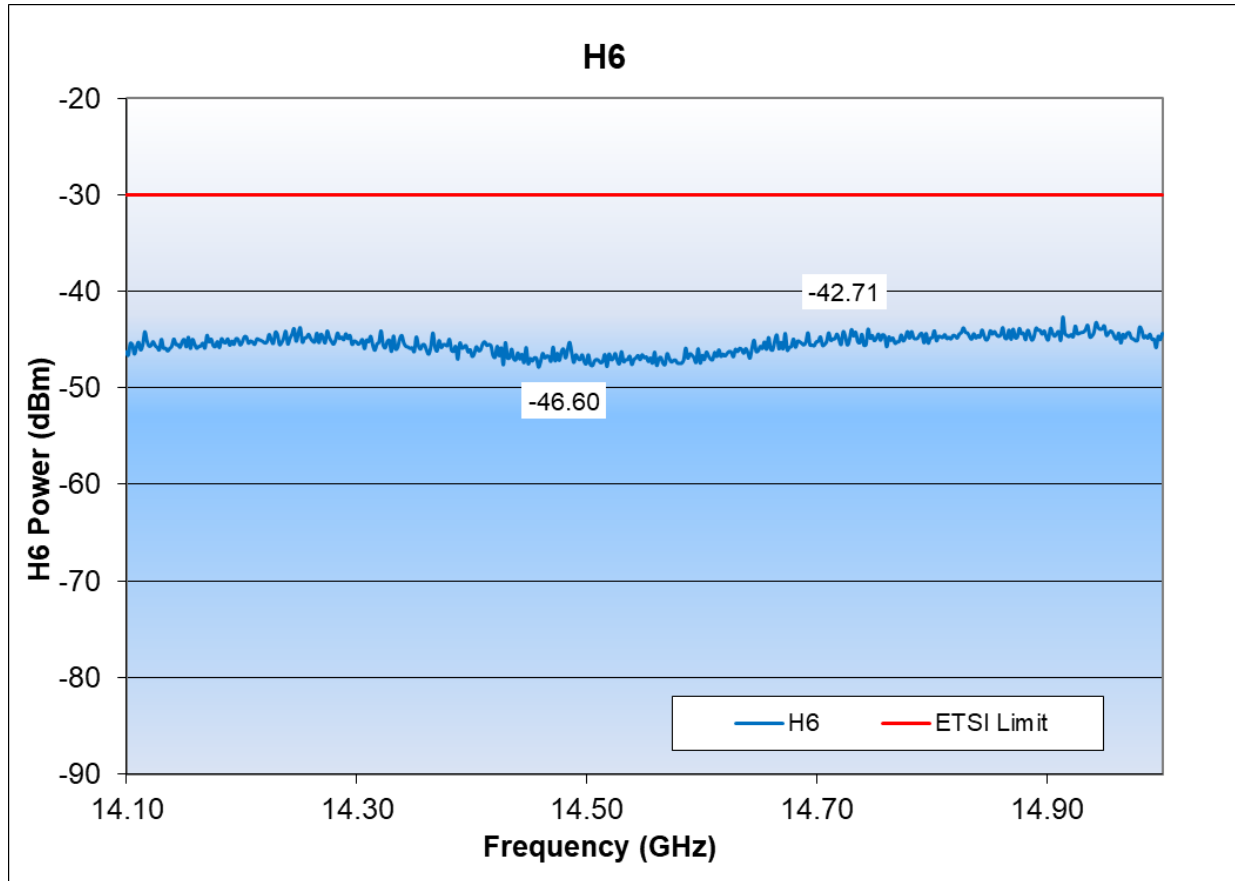

Figure 26. Conducted H6 spurious

- Maximum power is at frequency 14.91 GHz: -42.71 dBm

Conclusion:

- There is more than 12 dB margin to the ETSI limit

3.1.8.7. H7 @ +5 dBm (ETSI test conditions, peak measurement)

Same method as the H2, except that the spectrum analyzer frequency span is set from 16.45 GHz to 17.5 GHz.

Result:

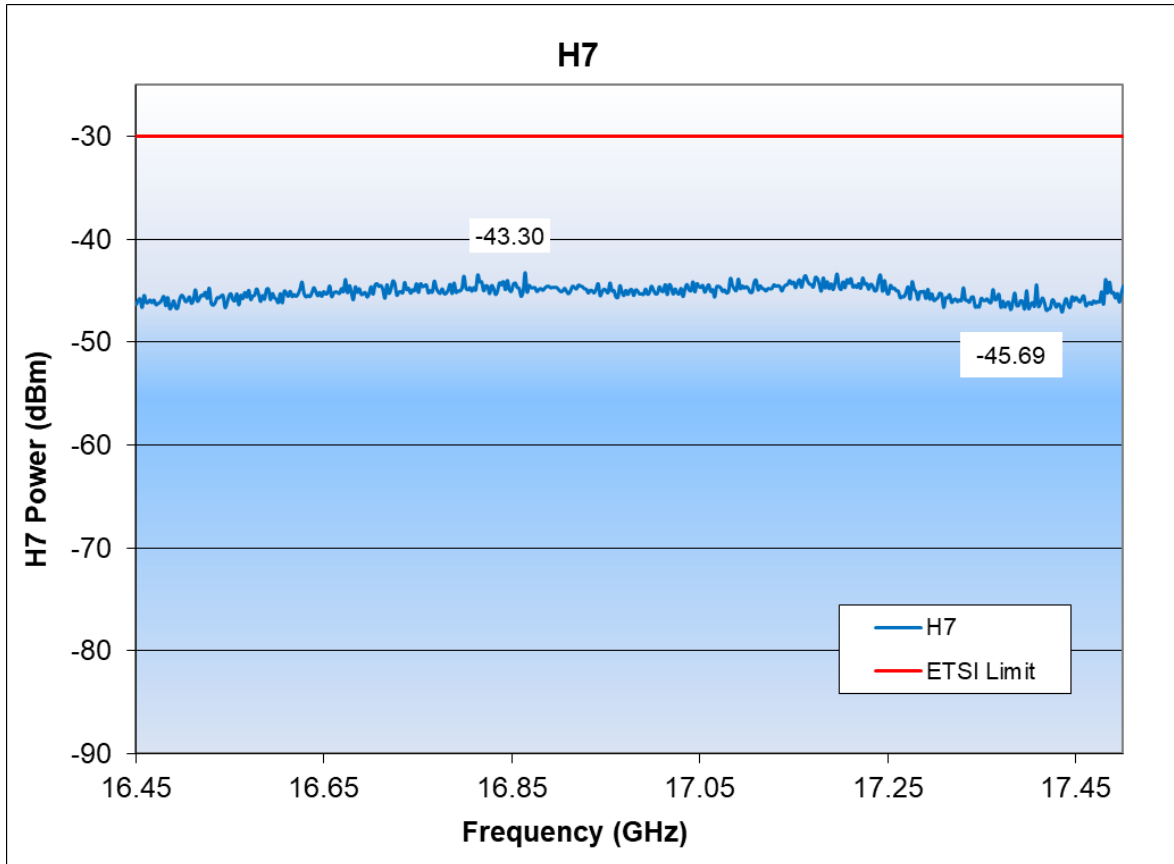

Figure 27. Conducted H7 spurious

- Maximum power is at frequency 17.19 GHz: -43.3 dBm

Conclusion:

- There is more than 13 dB margin to the ETSI limit

3.1.8.8. H8 @ +5 dBm (ETSI test conditions, peak measurement)

Same method as the H2, except that the spectrum analyzer frequency span is set from 18.8 GHz to 20 GHz.

Result:

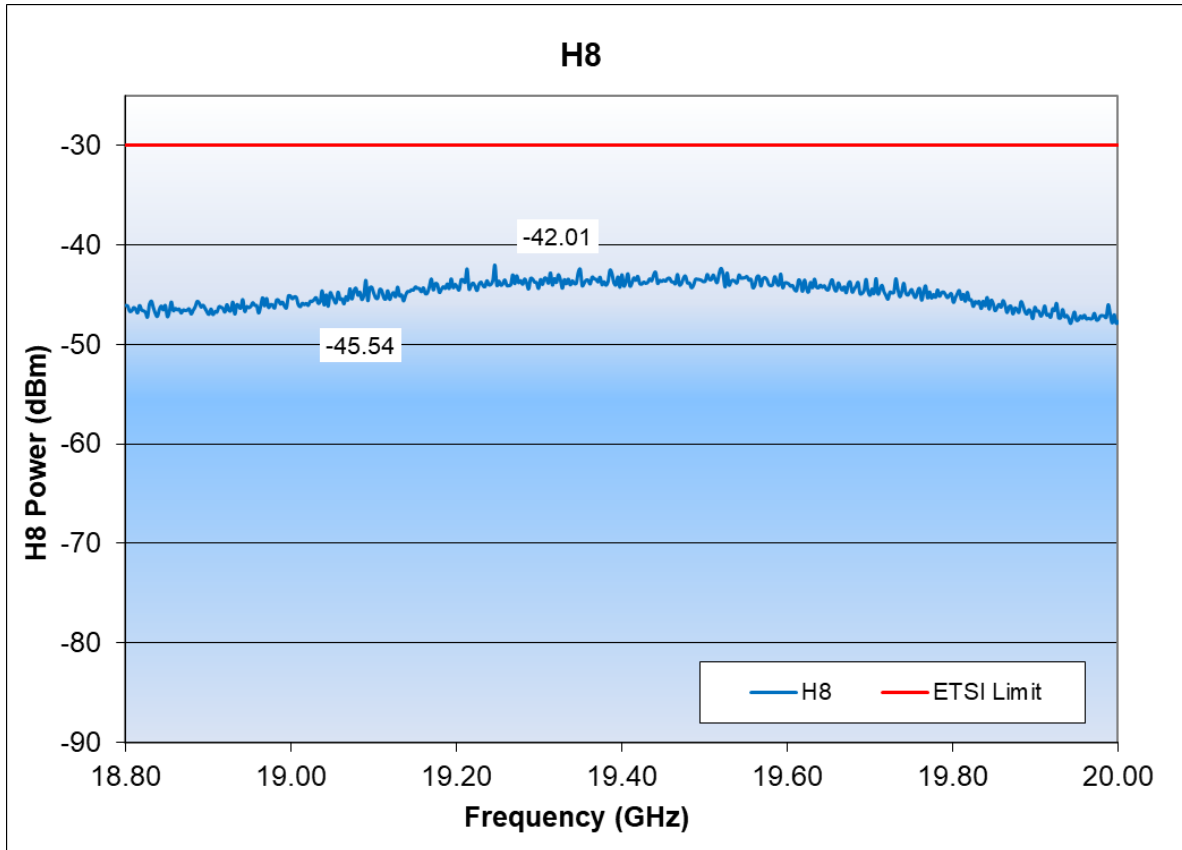

Figure 28. Conducted H8 spurious

- Maximum power is at frequency 19.24 GHz: -42.01 dBm

Conclusion:

- There is more than 12 dB margin to the ETSI limit

3.1.8.9. H9 @ +5 dBm (ETSI test conditions, peak measurement)

Same method as the H2, except that the spectrum analyzer frequency span is set from 21.15 GHz to 22.5 GHz.

Result:

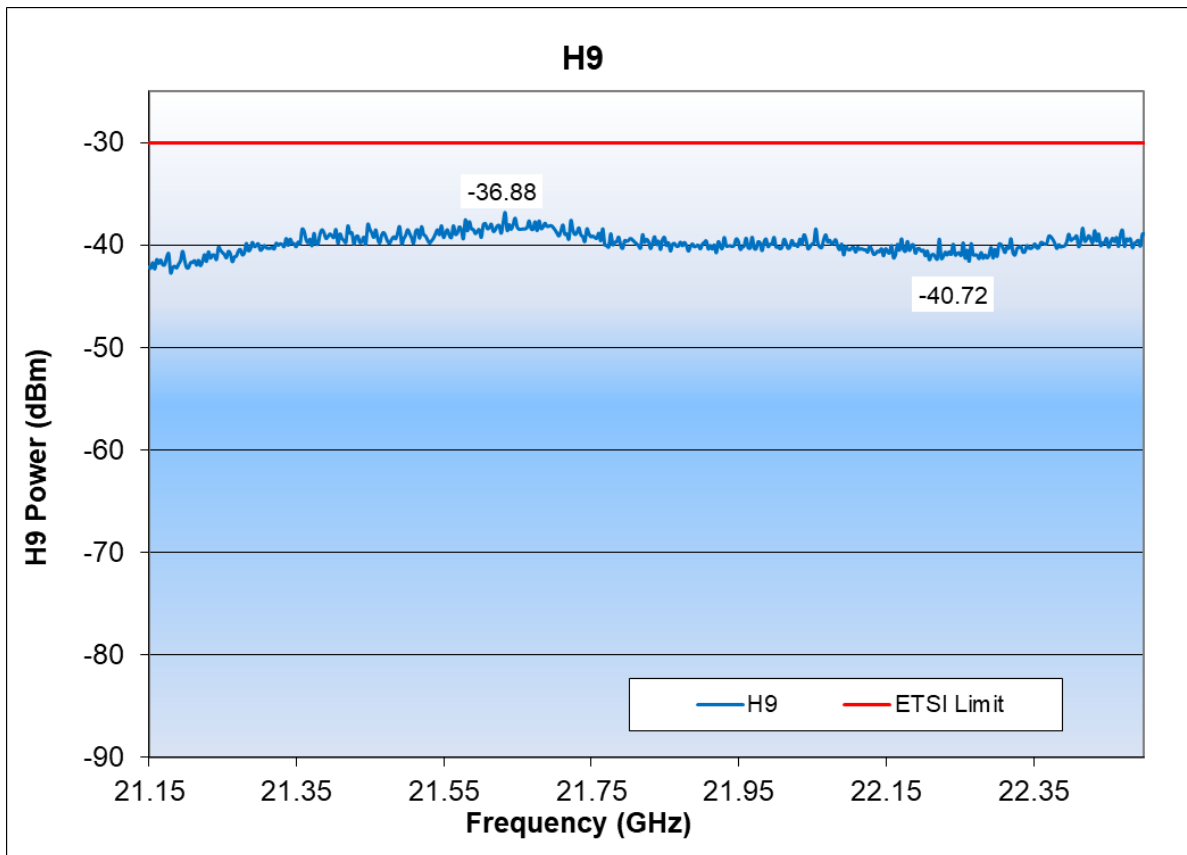

Figure 29. Conducted H9 spurious

- Maximum power is at frequency 21.63 GHz: -36.88 dBm

Conclusion:

- There is more than 6 dB margin to the ETSI limit

3.1.8.10. H10 @ +5 dBm (ETSI test conditions, peak measurement)

Same method as the H2, except that the spectrum analyzer frequency span is set from 23.5 GHz to 25 GHz.

Result:

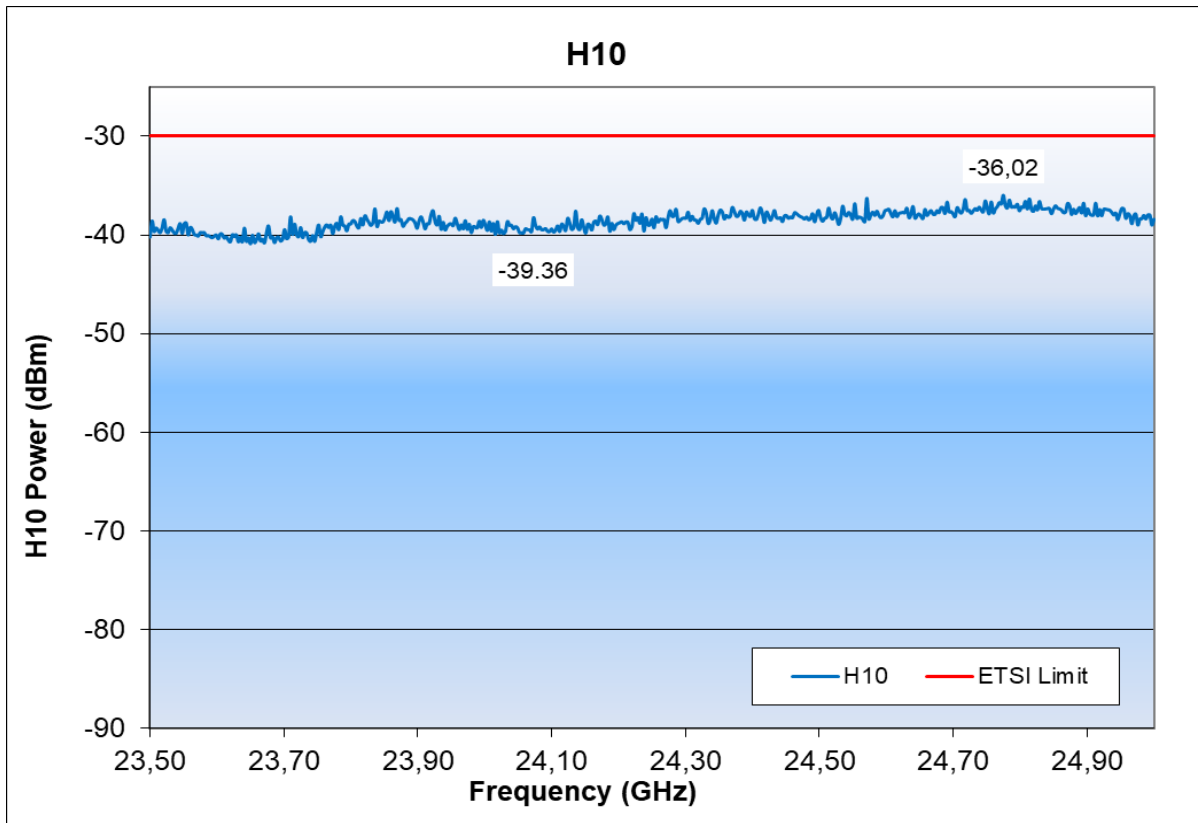

Figure 30. Conducted H10 spurious

- Maximum power is at frequency 24.77 GHz: -36.02 dBm

Conclusion:

- There is more than 6 dB margin to the ETSI limit

3.1.8.11. H2 @ +5 dBm (FCC test conditions, average measurements)

Test method:

- Set the radio to:
 - Tx mode, modulated, continuous mode
- Set the analyzer to:
 - Start freq = 4.7 GHz, Stop freq = 5 GHz, Ref amp = -20 dBm, sweep time = 100 ms, RBW = 1 MHz, VBW = 3 MHz
 - Trace: Max Hold mode
 - Detector: RMS
- Sweep all the channels from channel 0 to channel 39

Result:

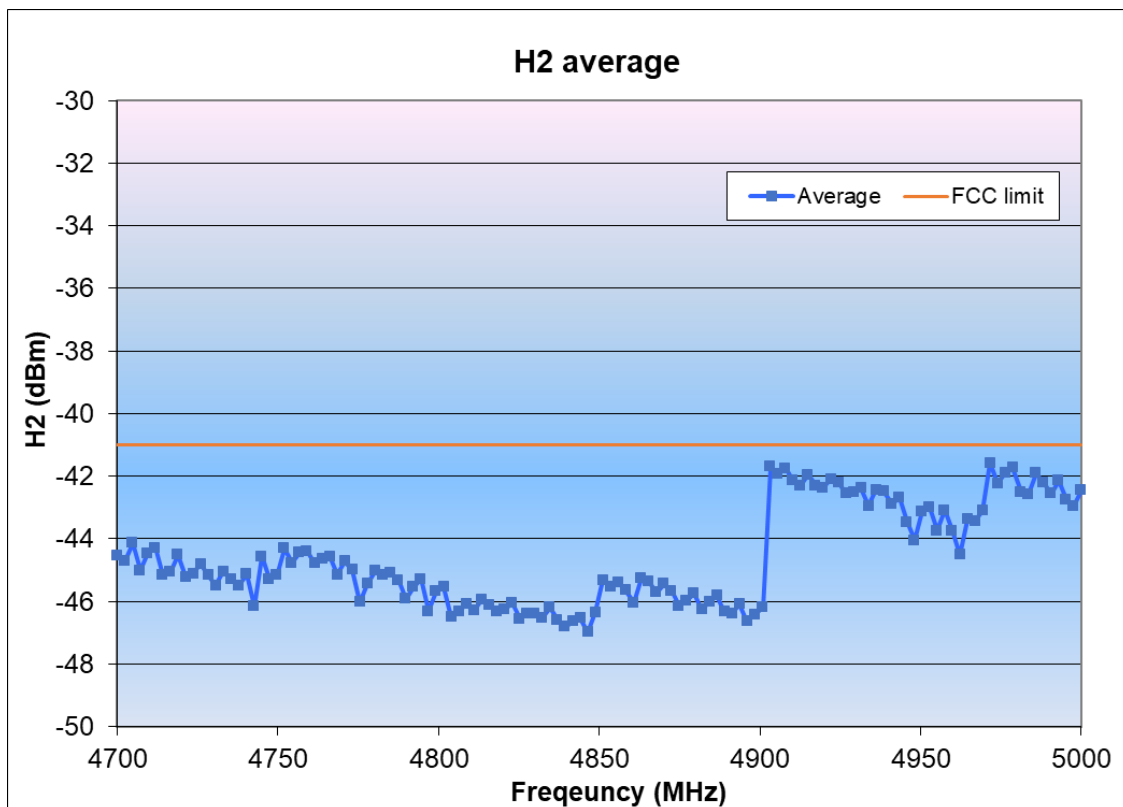

Figure 31. Conducted H2 FCC spurious

- Maximum power is at frequency 4.906 GHz: -41.57 dBm

Conclusion:

- There is 0.4 dB margin to the FCC limit

3.1.8.12. H3 @ +5 dBm (FCC test conditions, average measurements)

Same method as the H2, except that the spectrum analyzer frequency span is set from 7.0 GHz to 7.5 GHz.

Result:

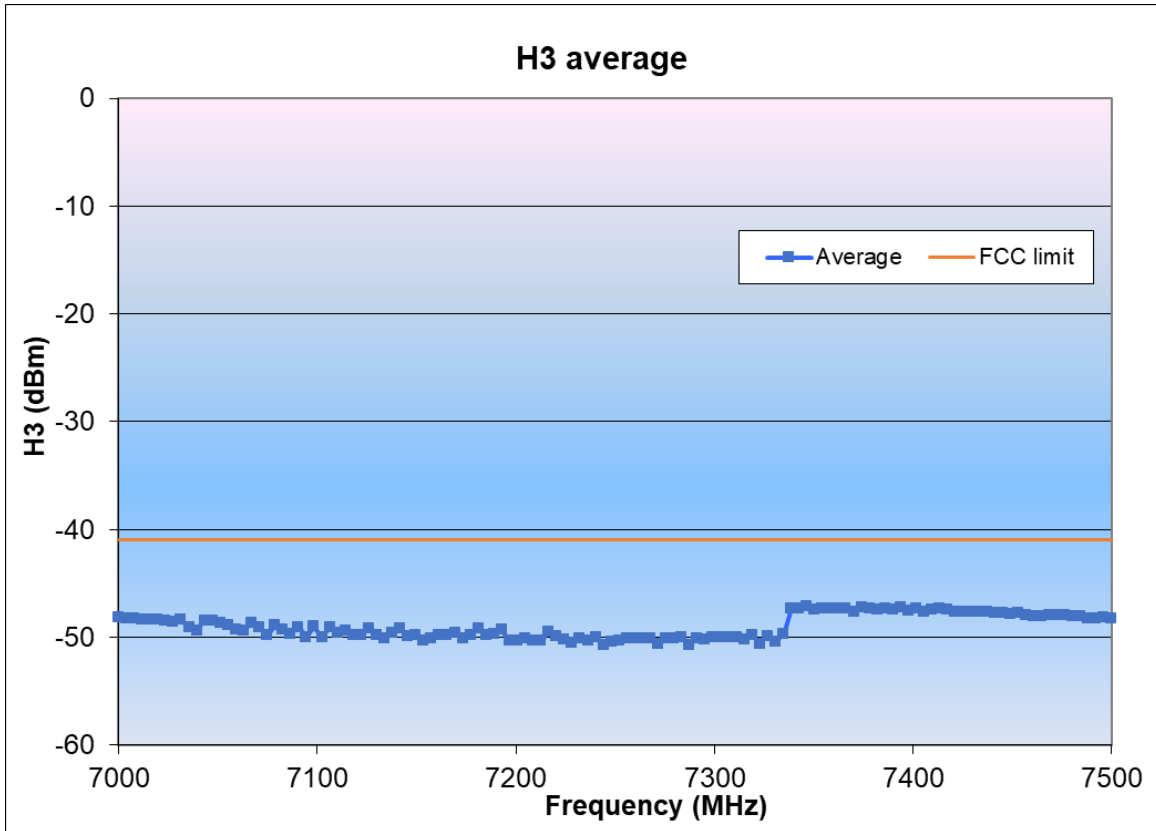

Figure 32. Conducted H3 FCC spurious

- Maximum power is at frequency 7.34 GHz: -47.16 dBm

Conclusion:

- There is more than 6 dB margin to the FCC limit

3.1.8.13. H4 @ +5 dBm (FCC test conditions, average measurements)

Same method as the H2, except that the spectrum analyzer frequency span is set from 9.4 GHz to 10 GHz.

Result:

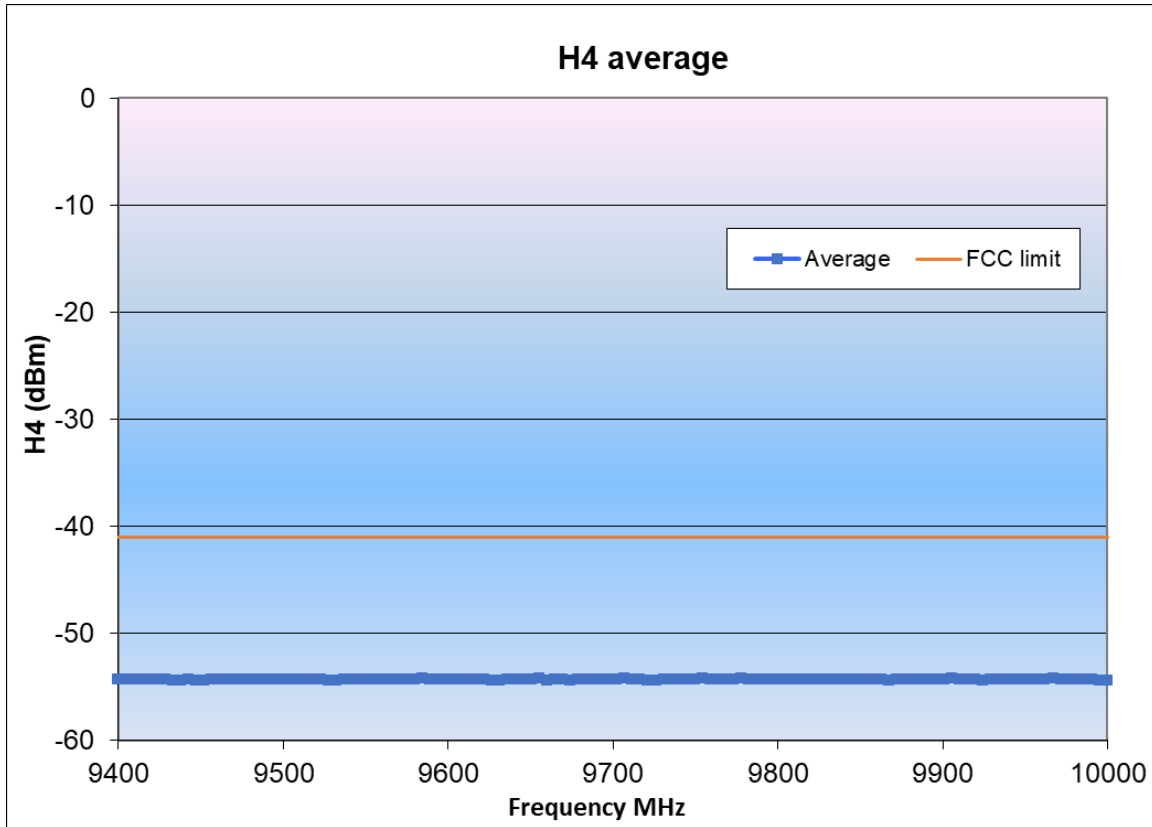

Figure 33. Conducted H4 FCC spurious

- Maximum power is at frequency 9.78 GHz: -54.18 dBm

Conclusion:

- There is more than 13 dB margin to the FCC limit

3.1.8.14. H5 @ +5 dBm (FCC test conditions, average measurements)

Same method as the H2, except that the spectrum analyzer frequency span is set from 11.7 GHz to 12.5 GHz.

Result:

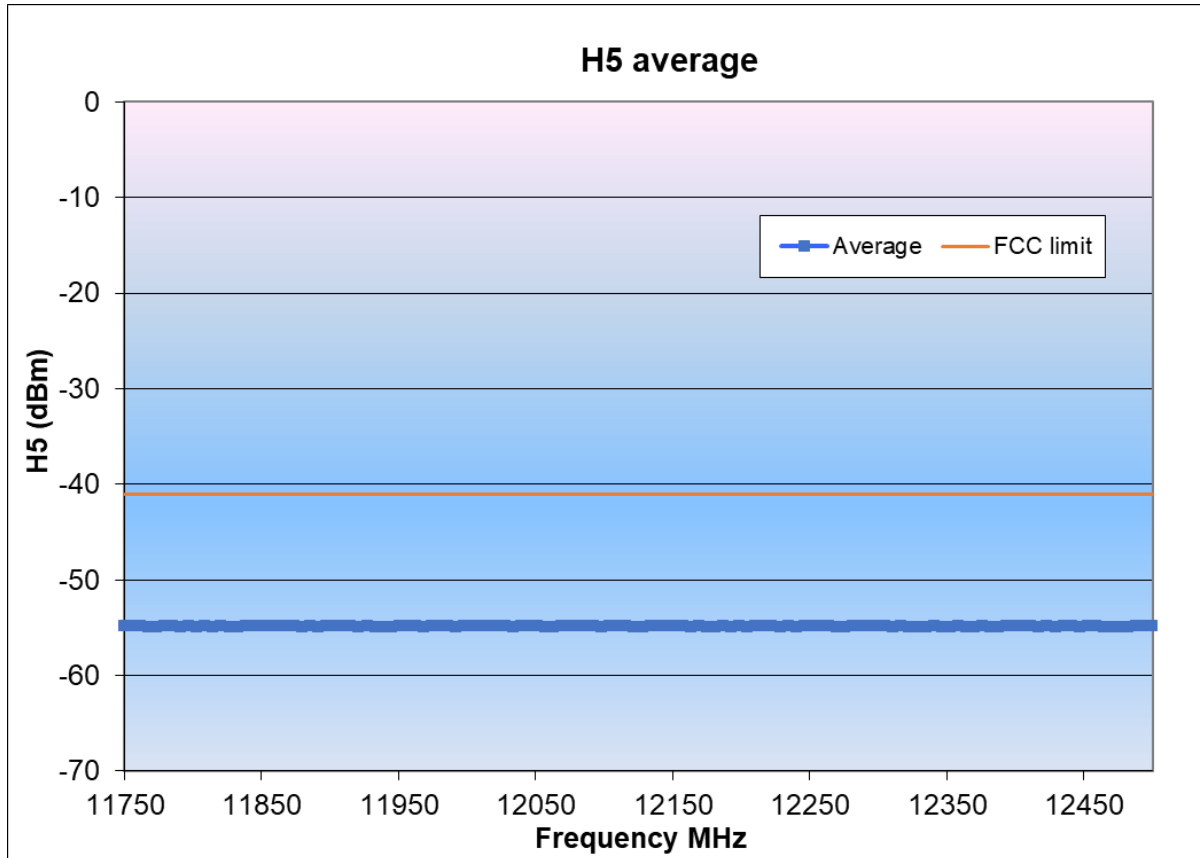

Figure 34. Conducted H5 FCC spurious

- Maximum power is at frequency 12.07 GHz: -54.8 dBm

Conclusion:

- There is more than 13 dB margin to the FCC limit

3.1.8.15. H6 @ +5 dBm (FCC test conditions, average measurements)

Same method as the H2, except that the spectrum analyzer frequency span is set from 14.1 GHz to 15 GHz.

Result:

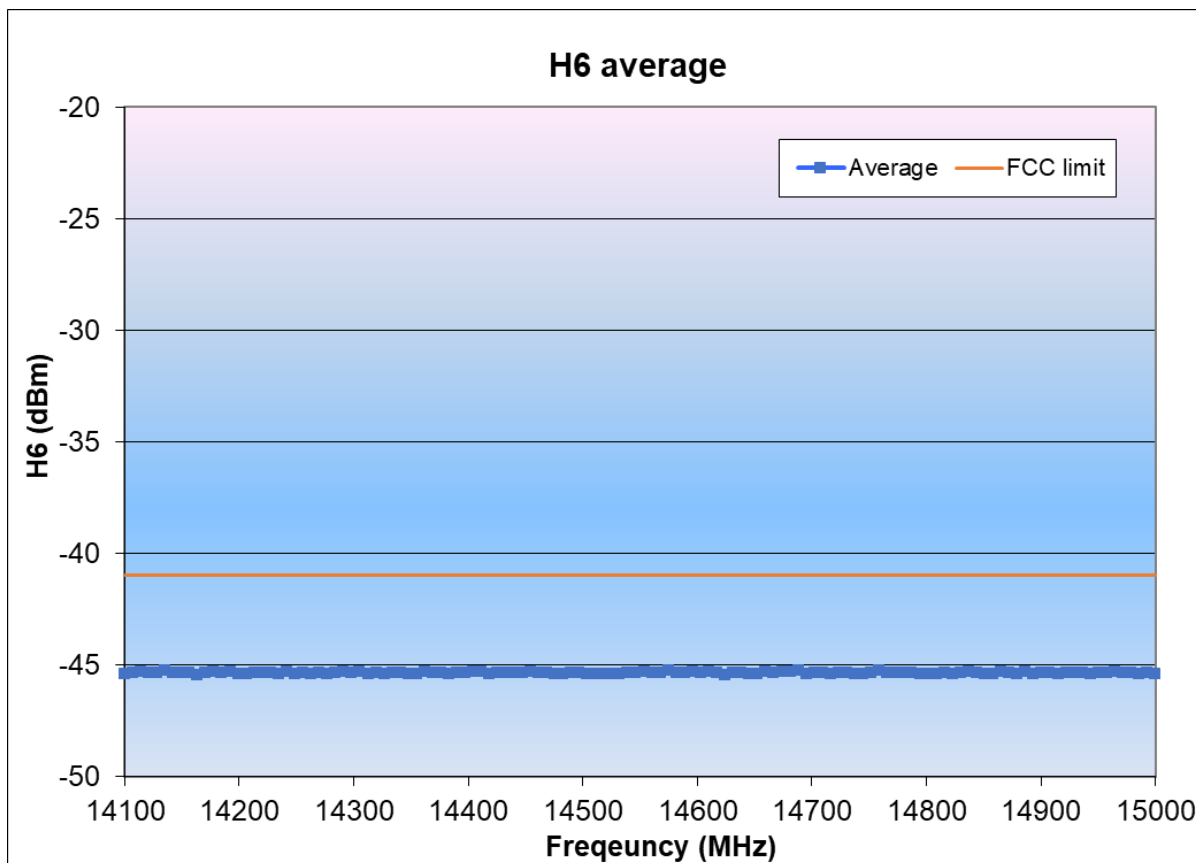

Figure 35. Conducted H6 FCC spurious

- Maximum power is at frequency 14.57 GHz: -45.23 dBm

Conclusion:

- There is more than 4 dB margin to the FCC limit

3.1.8.16. H7 @+5dBm (FCC test conditions, average measurements)

Same method as the H2, except that the spectrum analyzer frequency span is set from 16.45 GHz to 17.5 GHz.

Result:

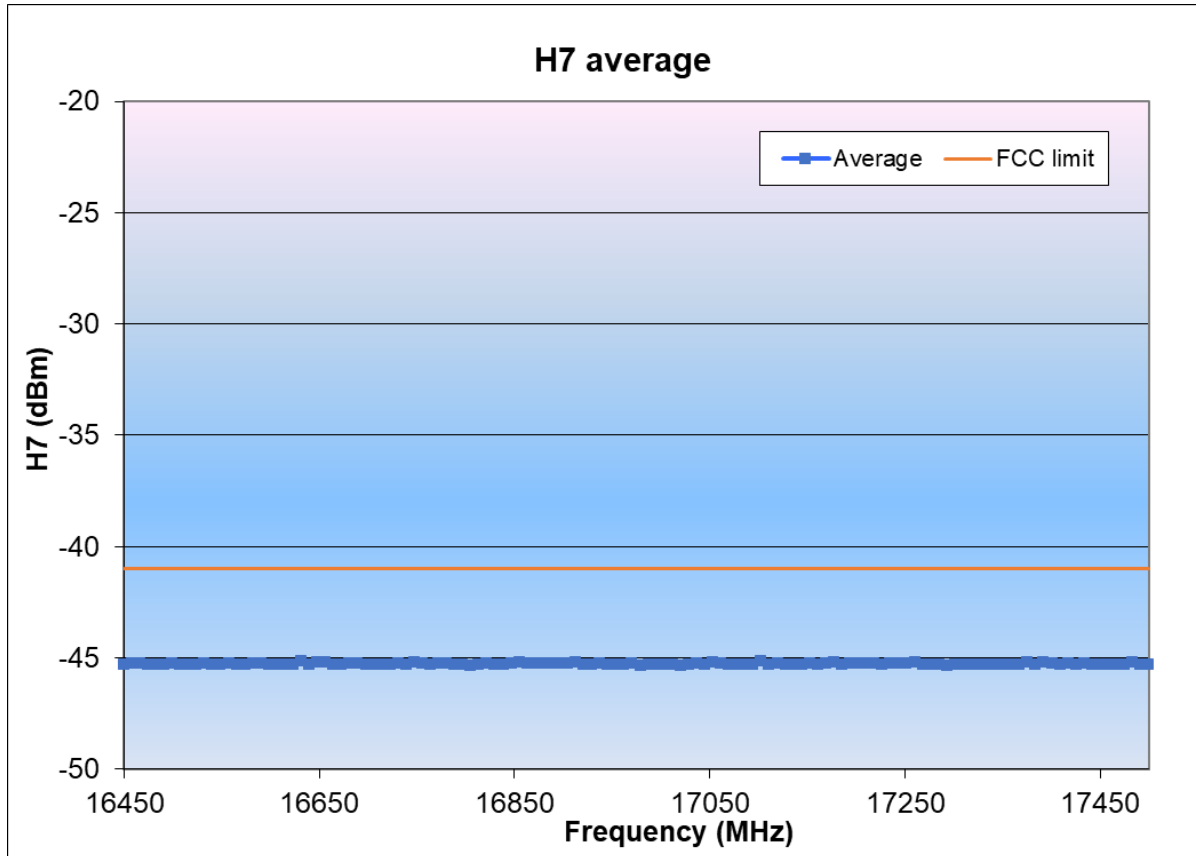

Figure 36. Conducted H7 FCC spurious

- Maximum power is at frequency 17.1 GHz: -45.15 dBm

Conclusion:

- There is more than 4 dB margin to the FCC limit

3.1.8.17. H8 @ +5 dBm (FCC test conditions, average measurements)

Same method as the H2, except that the spectrum analyzer frequency span is set from 18.8 GHz to 20 GHz.

Result:

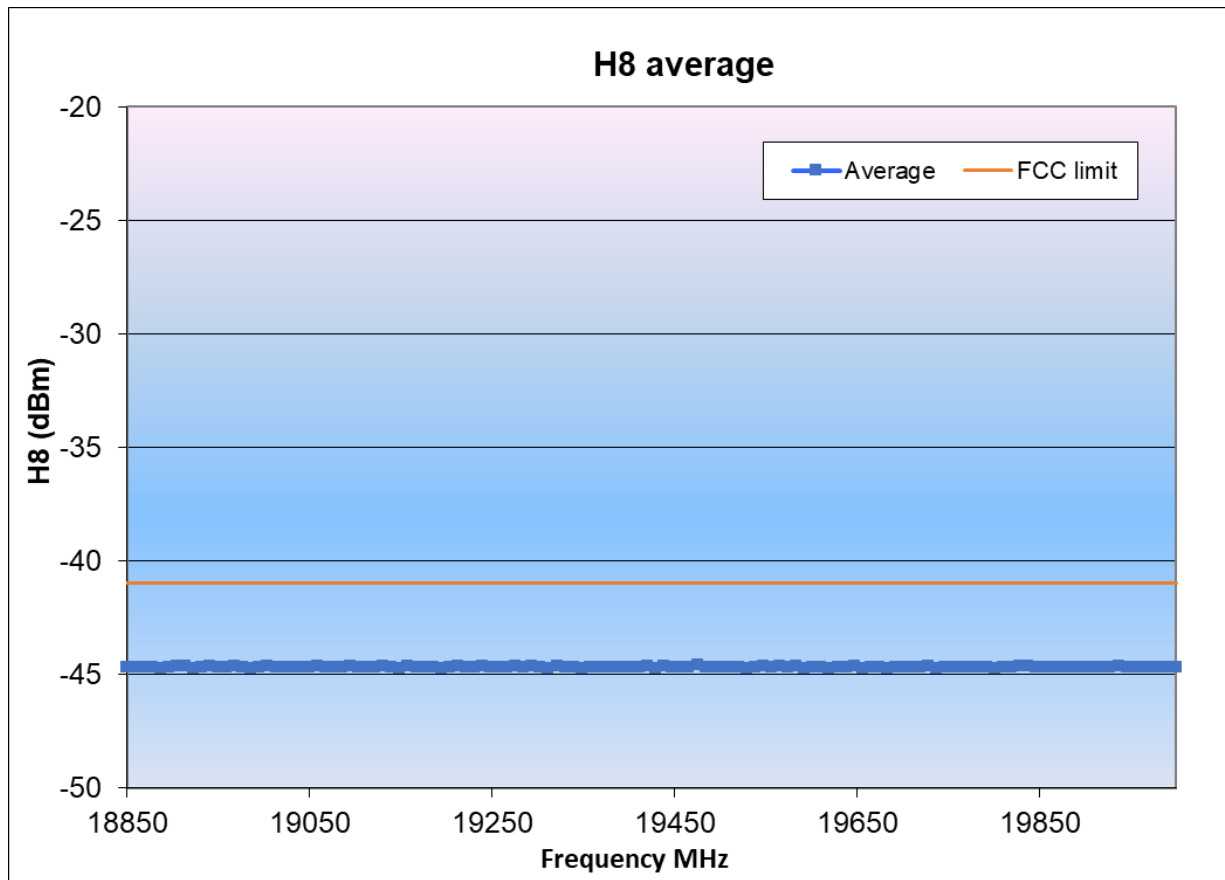

Figure 37. Conducted H8 FCC spurious

- Maximum power is at frequency 19.47 GHz: -44.6 dBm

Conclusion:

- There is more than 4 dB margin to the FCC limit

3.1.8.18. H9 @ +5 dBm (FCC test conditions, average measurements)

Same method as the H2, except that the spectrum analyzer frequency span is set from 21.15 GHz to 22 GHz.

Result:

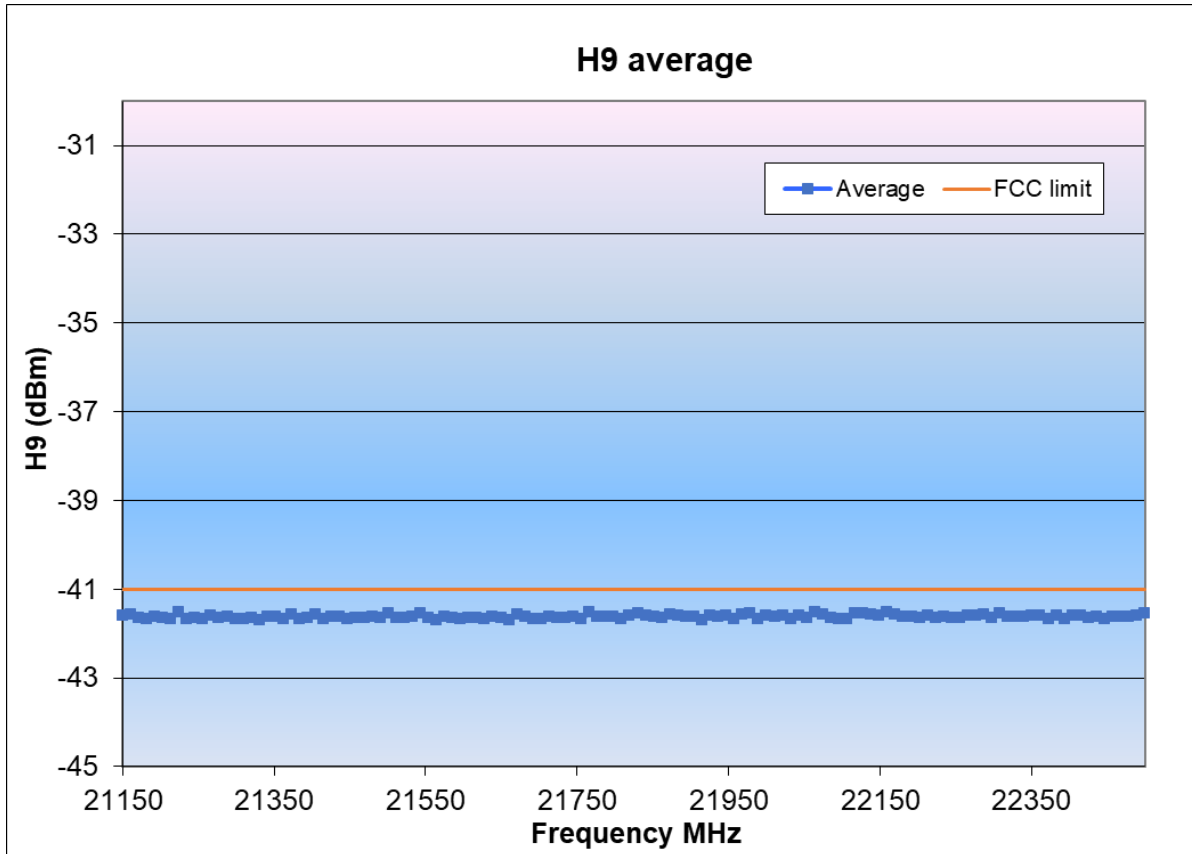

Figure 38. Conducted H9 FCC spurious

- Maximum power is at frequency 21.2 GHz: -41.56 dBm

Conclusion:

- There is low margin to the FCC limit

3.1.8.19. H10 @ +5 dBm (FCC test conditions, average measurements)

Same method as the H2, except that the spectrum analyzer frequency span is set from 23.5 GHz to 25 GHz.

Result:

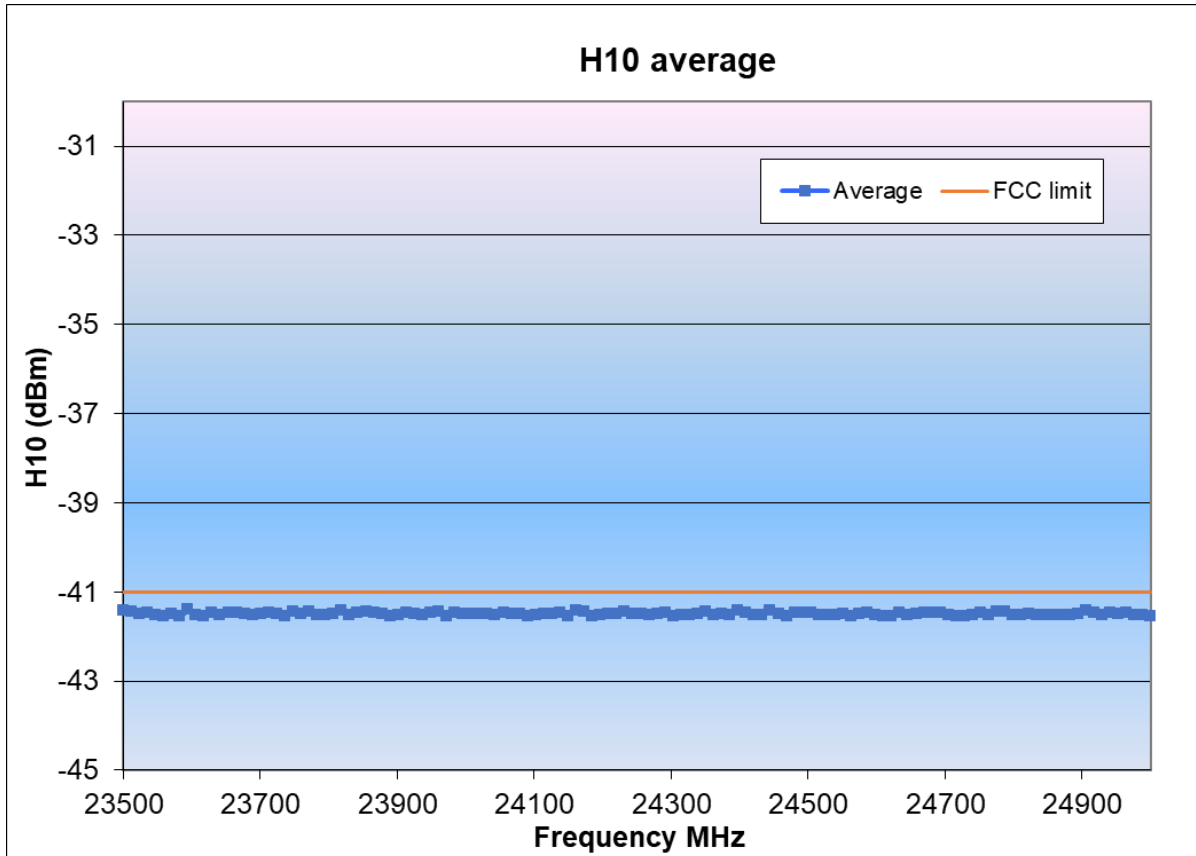

Figure 39. Conducted H10 FCC spurious

- Maximum power is at frequency 23.6 GHz: -41.4 dBm

Conclusion:

- There is low margin to the FCC limit

3.1.9. Upper band edge

Test method:

- Set the radio to:
 - Ch39 RF output power MUST be set to -3.5 dBm (Connectivity test value = power 13)
 - TX mode, modulated, continuous mode
- Set the analyzer to:
 - Start freq = 2.475 GHz, Stop freq = 2.485 GHz, Ref amp = -20 dBm, sweep time = 100 ms
 - RBW = 1 MHz, Video BW = 3 MHz
 - Detector = average
 - Average mode : power
 - Number of sweeps = 100
 - Set the channel 39 (2.48 GHz)

Result:

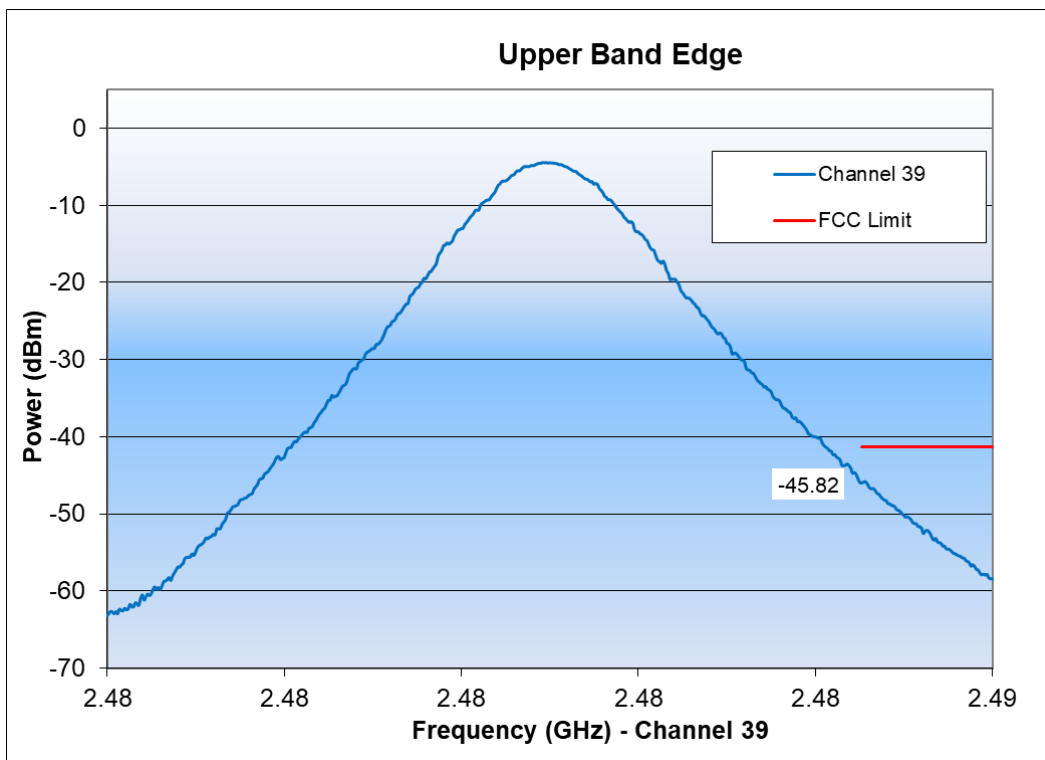

Figure 40. Upper band edge—channel 39

Conclusion:

- The upper band edge test passes the FCC certification
- There is 4.7 dB margin to the FCC limit

3.1.10. Modulation characteristics

The CMW equipment is used to measure the frequency deviation between df1 and df2. A specific binary is flashed: *hci_blackbox.bin*.

Test method:

- Generator for the desired signal: CMW R&S®
- Criterion: PER < 30.8 % with 1500 packets
- Channels under test: 0, 19, and 39

Result:

Table 8. Modulation characteristics

TP/TRM-LE/CA/BV-05-C [Modulation Characteristics]	Lower Limit	Upper Limit	Measured	Unit	Status
Payload length: 37, Statistic Count: 10					
Channel 0					
Frequency Deviation df1 Average	225	275	250.94	kHz	Passed
Frequency Deviation df2 99.9%	185	---	219.53	kHz	Passed
Frequency Deviation df2 Average / df1 Average	0.80	---	0.92	---	Passed
Channel 19					
Frequency Deviation df1 Average	225	275	250.56	kHz	Passed
Frequency Deviation df2 99.9%	185	---	221.93	kHz	Passed
Frequency Deviation df2 Average / df1 Average	0.80	---	0.92	---	Passed
Channel 39					
Frequency Deviation df1 Average	225	275	250.41	kHz	Passed
Frequency Deviation df2 99.9%	185	---	222.53	kHz	Passed
Frequency Deviation df2 Average / df1 Average	0.80	---	0.93	---	Passed

Conclusion:

- Good margins, in line with the expected results

3.1.11. Carrier frequency offset and drift

The CMW equipment is used to measure the frequency deviation between df1 and df2. A specific binary is flashed: *hci_blackbox.bin*.

Test method:

- Generator for the desired signal: CMW270 R&S

Conducted tests

- Criterion: PER < 30.8 % with 1500 packets
- Channels under test: 0, 19, and 39

Result:

Table 9. Carrier frequency offset and drift

TP/TRM-LE/CA/BV-06-C [Carrier frequency offset and drift]	Lower Limit	Upper Limit	Measured	Unit	Status
Payload length: 37, Statistic Count: 10					
Channel 0					
Frequency Accuracy	-150.00	150.00	-12.04	kHz	Passed
Frequency Offset	-150.00	150.00	-12.79	kHz	Passed
Frequency Drift	-50.00	50.00	-1.75	kHz	Passed
Max Drift Rate	-20.00	20.00	1.69	kHz	Passed
Initial Frequency Drift	-23.00	23.00	1.36	kHz	Passed
Channel 19					
Frequency Accuracy	-150.00	150.00	-11.89	kHz	Passed
Frequency Offset	-150.00	150.00	-12.75	kHz	Passed
Frequency Drift	-50.00	50.00	-2.01	kHz	Passed
Max Drift Rate	-20.00	20.00	-1.56	kHz	Passed
Initial Frequency Drift	-23.00	23.00	-1.46	kHz	Passed
Channel 39					
Frequency Accuracy	-150.00	150.00	-12.67	kHz	Passed
Frequency Offset	-150.00	150.00	-13.04	kHz	Passed
Frequency Drift	-50.00	50.00	-1.95	kHz	Passed
Max Drift Rate	-20.00	20.00	-1.47	kHz	Passed
Initial Frequency Drift	-23.00	23.00	-1.11	kHz	Passed

Conclusion:

- Good margins, in line with the expected results

3.2. RX tests

3.2.1. Test setup

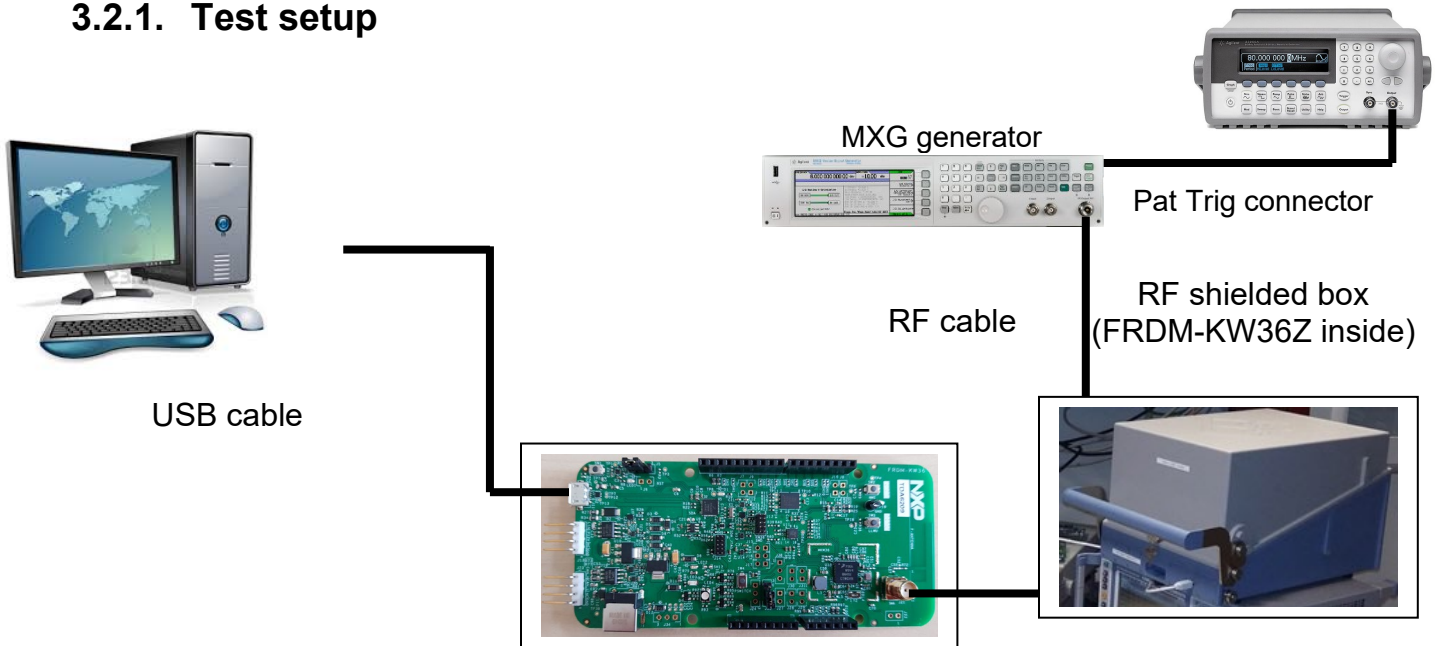

Figure 41. Conducted Rx test setup for sensitivity with RF generator and faraday box

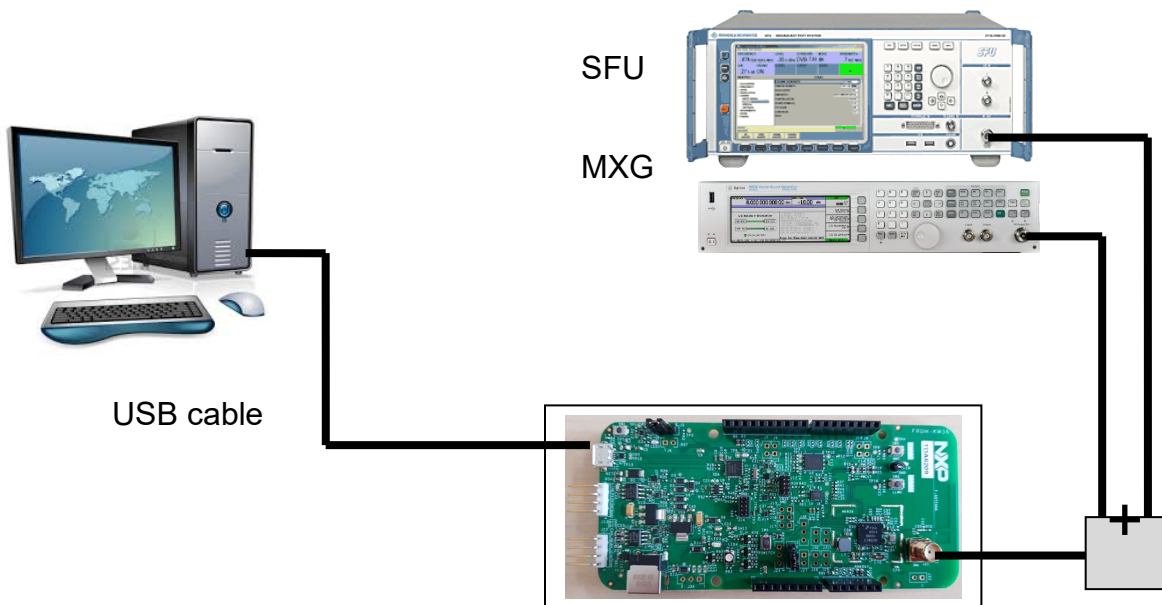

Figure 42. Conducted RX test setup for interference rejection

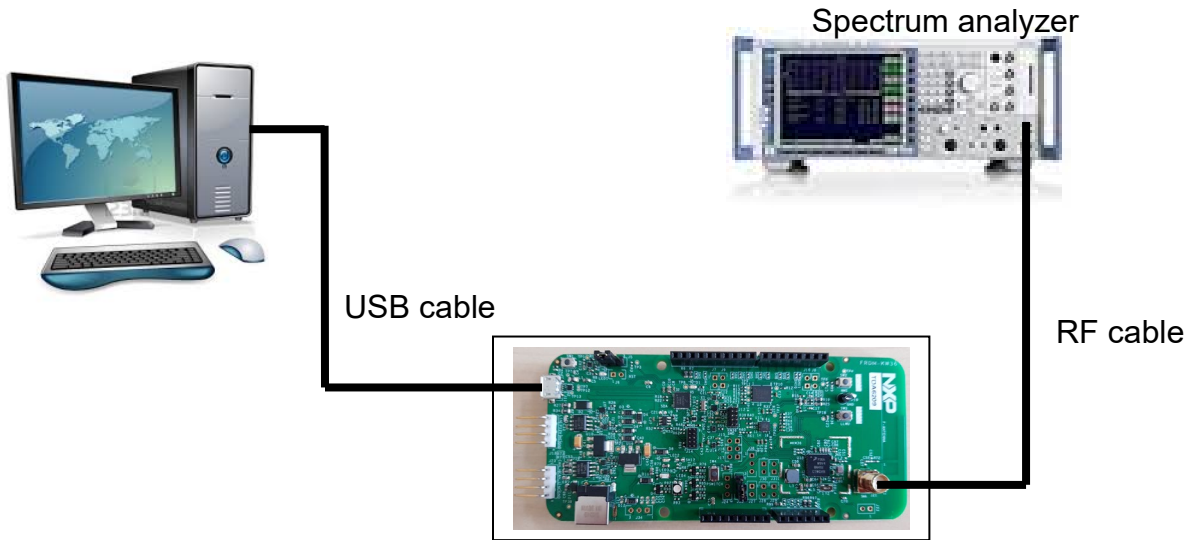

Figure 43. Conducted RX test setup for spurious

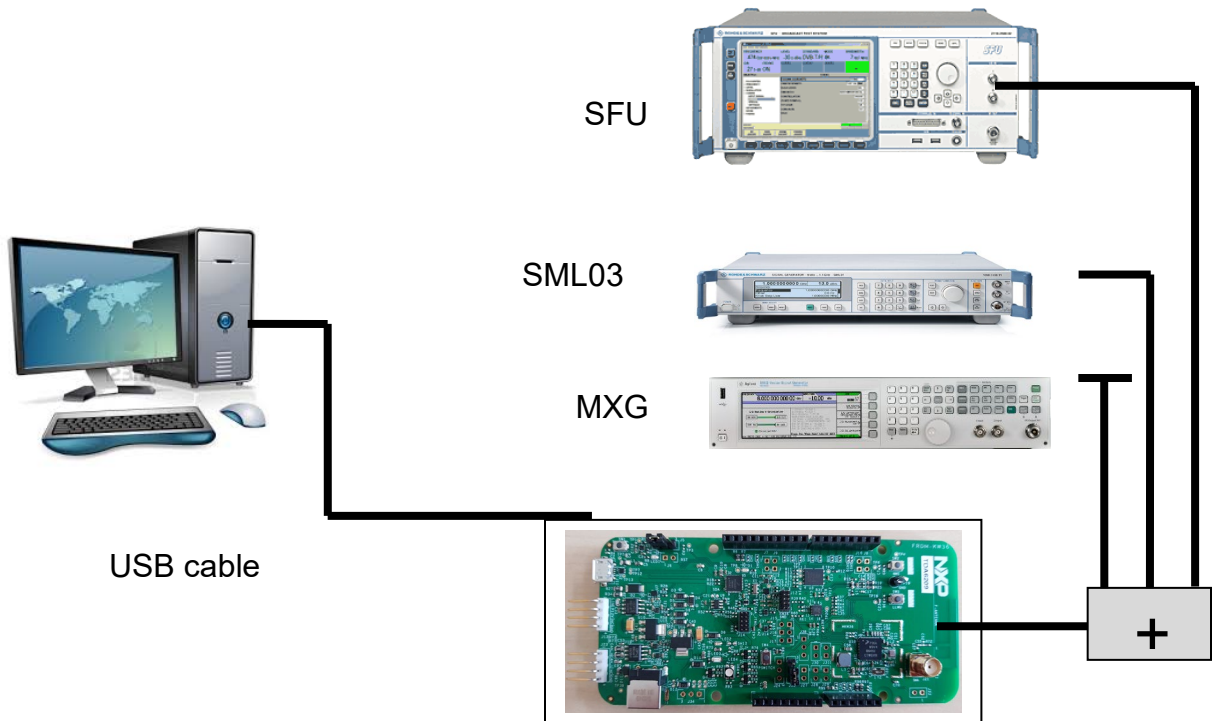

Figure 44. Conducted Rx test setup for intermodulation performances

3.2.2. Sensitivity

3.2.2.1. With the ARB generator

Test method:

- To remain immune to the external parasitic signals, FRDM-KW36 is put into an RF shielded box.



Figure 45. Sensitivity test

The generator (Agilent NX5181 MXG) is used in the ARB mode to generate a pattern of 1500 packets. The TERATERM window is used to control the module.

- Set it to channel 0
- The connection is automatically established and the PER (Packet Error Rate) is measured
- Decrease the level of the SFU at the RF input of the module until PER = 30.8 %
- Repeat it up to channel 39

Conducted tests

Results:

- LDO-HF not bumped

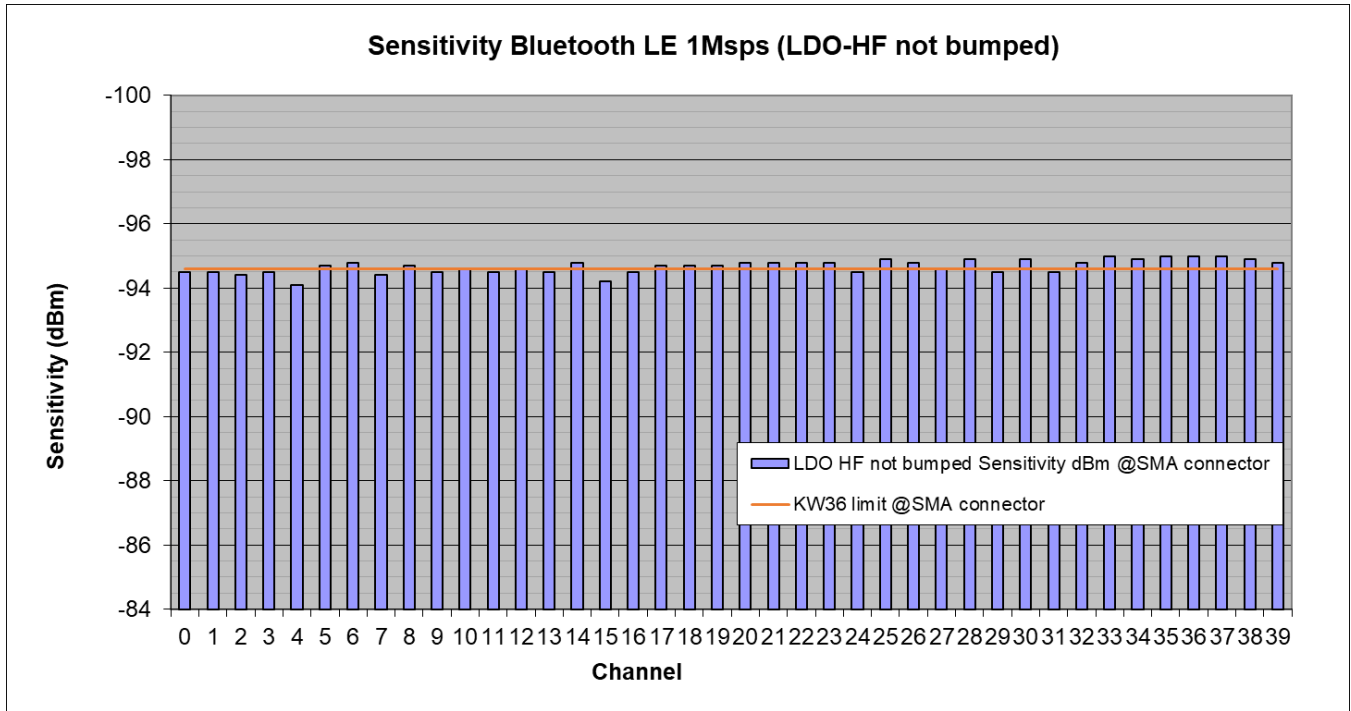

Figure 46. Sensitivity result (LDO-HF not bumped)

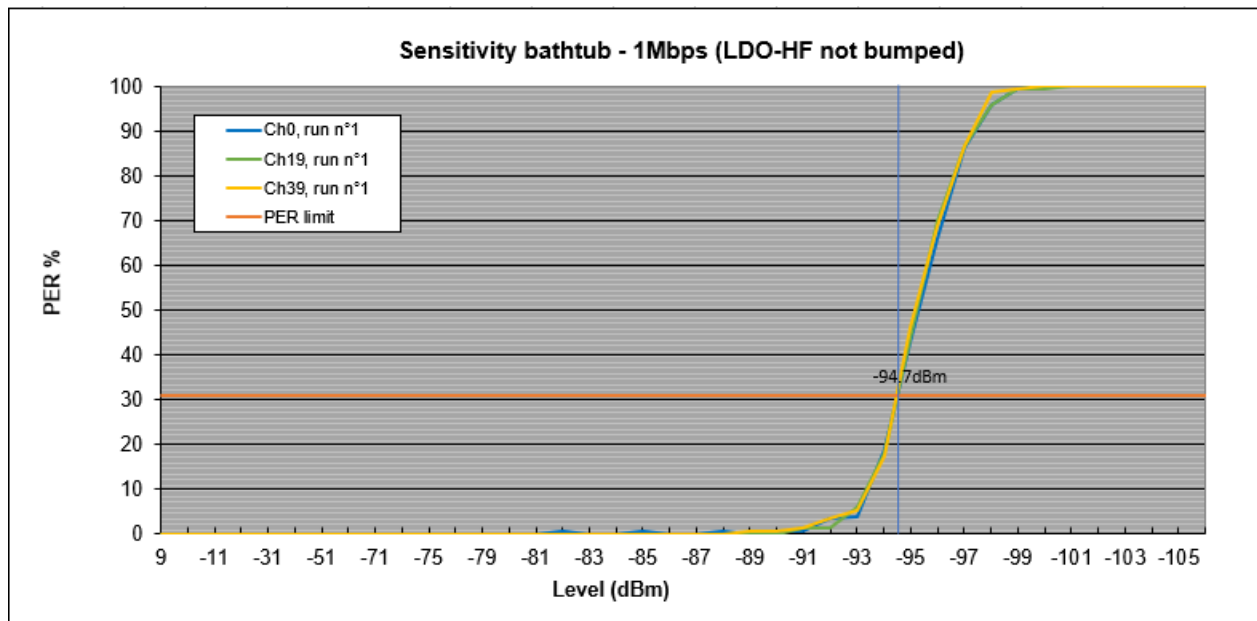

Figure 47. Bathtub results on 3 channels 0, 19, 39 (LDO-HF not bumped)

- The best sensitivity is on channel 33,35,36,37: -95.0 dBm
- The lowest sensitivity is on channel 3,15: -94.1 dBm
- Delta over channels: 0.9 dB

- LDO-HF bumped

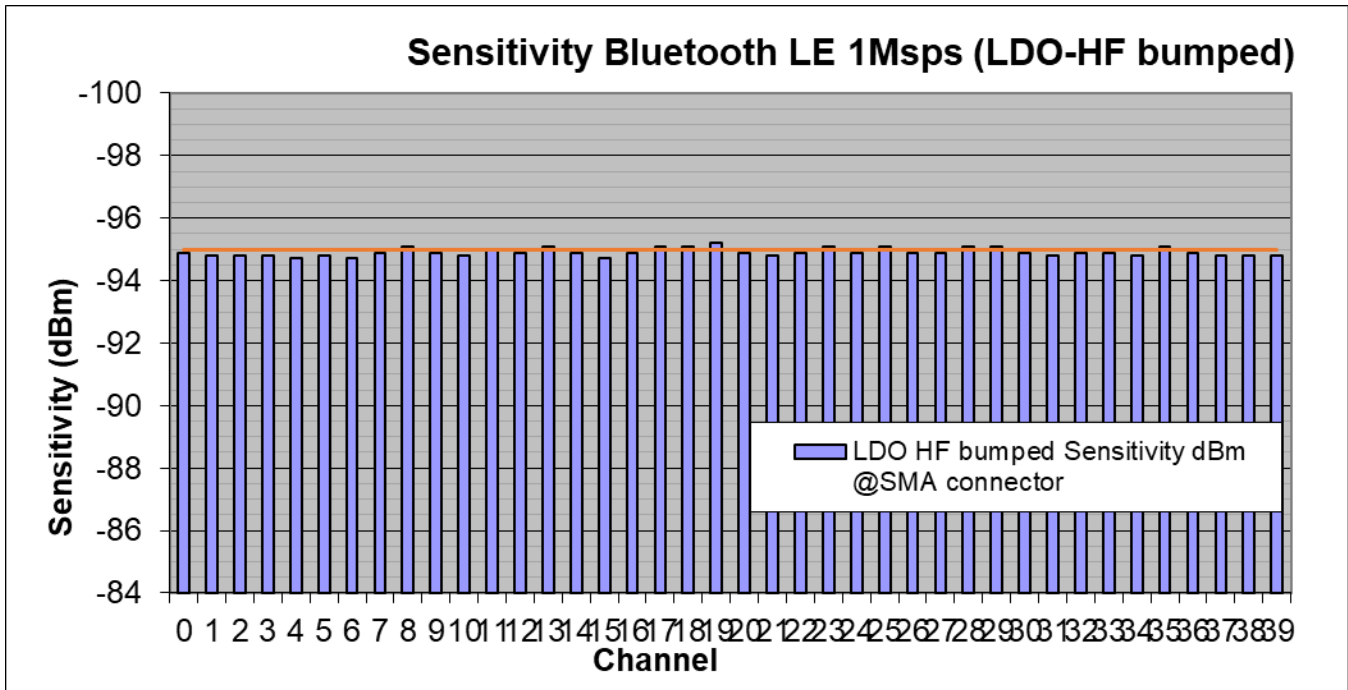

Figure 48. Sensitivity result (LDO-HF bumped)

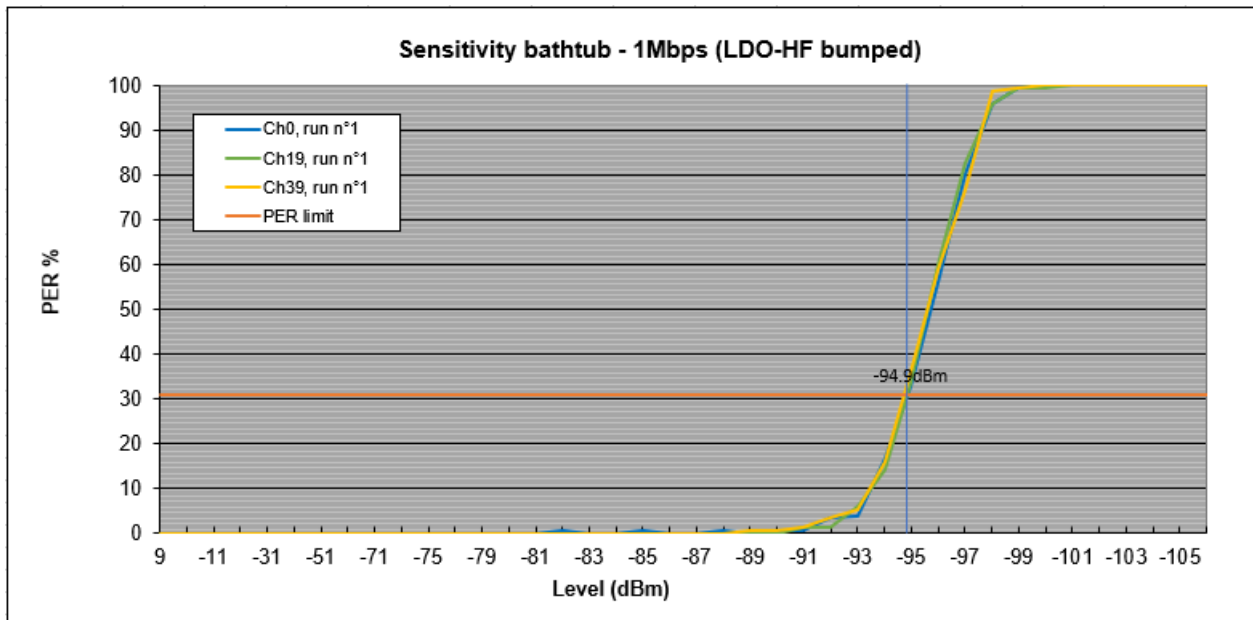

Figure 49. Bathtub results on 3 channels 0, 19, 39 (LDO-HF bumped)

- The best sensitivity is on channel 33,35,36,37: -95.2 dBm
- The lowest sensitivity is on channel 3,15: -94.7 dBm
- Delta over channels: 0.5 dB
- Conclusion:
 - FRDM-KW36 shows an average value of:

Conducted tests

- -94.9 dBm (LDO-HF bumped)
- -94.7 dBm (LDO-HF not bumped)

3.2.3. Receiver maximum input level

Test method:

- The same test setup as with the sensitivity test is used
- The signal level is increased until PER = 30.8 % with 1500 packets

Results:

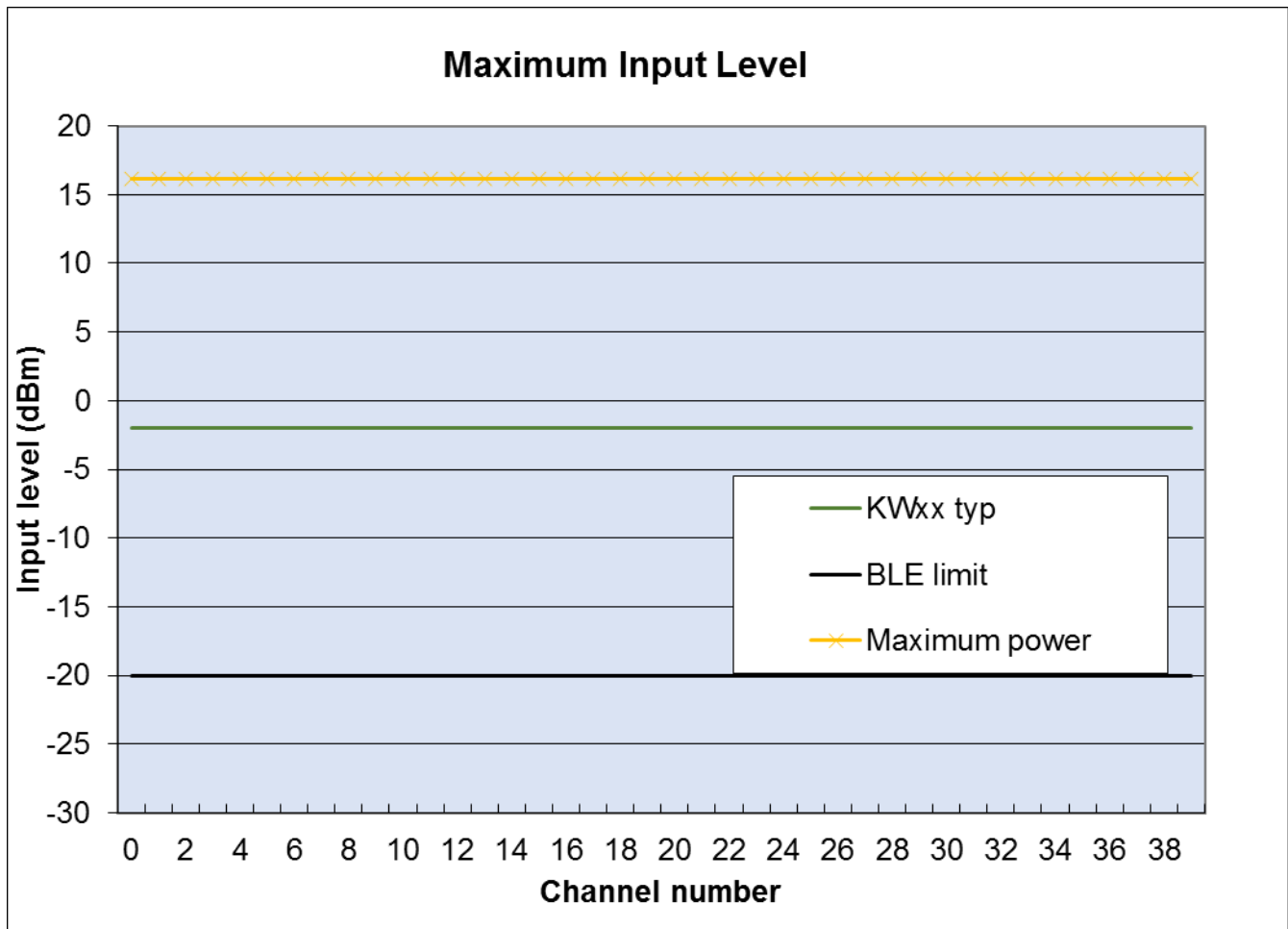

Figure 50. Maximum input power

Conclusion:

- The results are in line with the expected values

3.2.4. RX spurious

Test method:

- Set the radio to:
 - Receiver mode, frequency: channel 18
- Set the analyzer to:
 - Ref amp = - 20 dBm, Trace = max hold, detector = max peak
 - Start/stop frequency: 30 MHz/1 GHz
 - RBW = 100 kHz, VBW = 300 kHz
 - Then set the start/stop frequency: 1 GHz/30 GHz
 - RBW = 1 MHz, VBW = 3 MHz

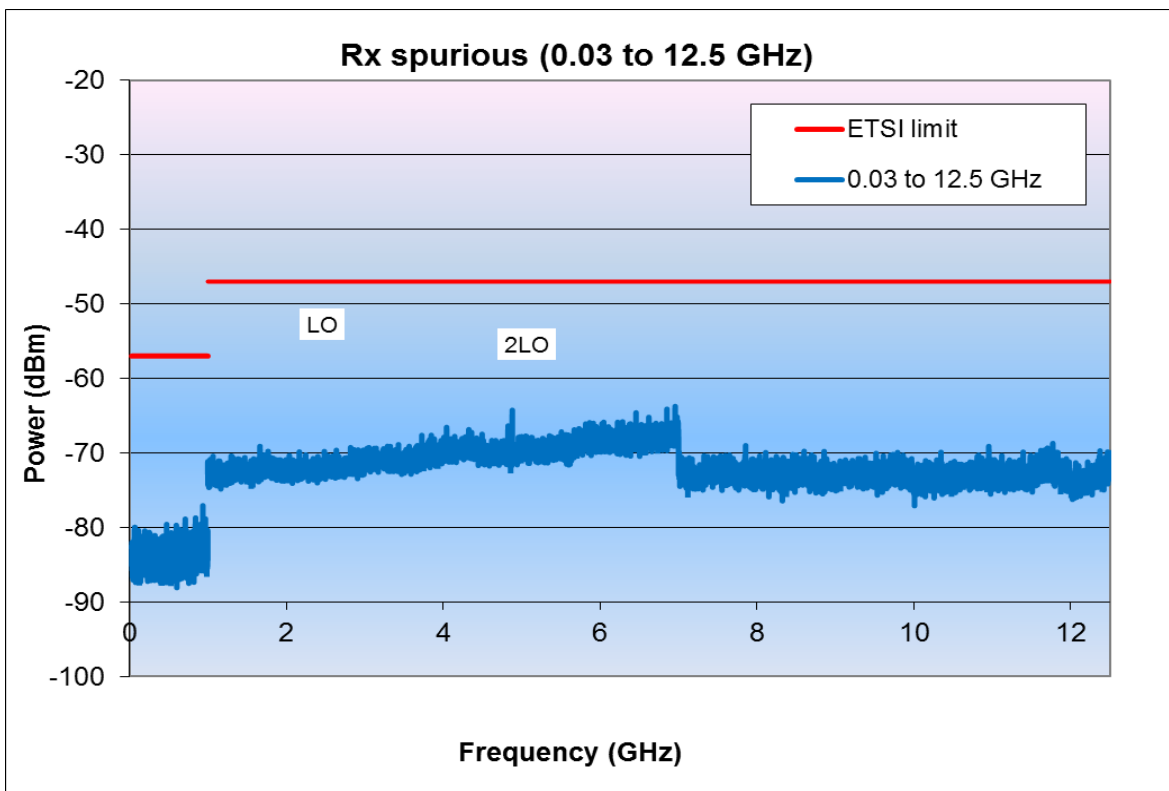

Figure 51. Conducted RX spurious 30 MHz – 12.5 GHz

Conclusion:

- There are no spurs above the spectrum analyzer noise floor, except for 2xLO
- More than 16-dB margin

3.2.5. Receiver interference rejection performances

3.2.5.1. Adjacent, alternate, and co-channel rejection

The interferers are located at the adjacent channels (+/-1 MHz, +/-2 MHz, +/-3 MHz) or the co-channel. The test is performed with only one interfering unmodulated signal at a time.

Test method:

- Generator for the desired signal: Agilent N5182A
- Generator for the interferers: R&S SFU
- Criterion: PER < 30.8 % with 1500 packets
- The wanted signal is set to -67 dBm; the interferer is increased until the PER threshold is reached
- Channels under test: 2, 19, and 37

Results:

Table 10. Adjacent, alternate, and co-channel rejection

	ch2 2406				ch19 2440				ch37 2476			
	N-2MHz	N-1MHz	N+1MHz	N+2MHz	N-2MHz	N-1MHz	N+1MHz	N+2MHz	N-2MHz	N-1MHz	N+1MHz	N+2MHz
	Interferer level (dBm)	2402	2404	2408	2410	2436	2438	2442	2444	2472	2474	2478
Interferer level (C/I dB)	-23.6	-62.1	-62.1	-25.6	-23.6	-62.1	-62.1	-22.1	-24.1	-62.1	-62.1	-22.6
BLE 4.2 limit (C/I dB)	-17	15	15	-17	-17	15	15	-17	-17	15	15	-17
Margin (dB)	26.4	19.9	19.9	24.4	26.4	19.9	19.9	27.9	25.9	19.9	19.9	27.4

	ch2 2406		Co-channel ch2 2406 N 2406	ch19 2440		Co-channel ch19 2440 N 2440	ch37 2476		Co-channel ch37 2476 N 2476
	N-3MHz	N+3MHz		N-3MHz	N+3MHz		N-3MHz	N+3MHz	
	Interferer level (dBm)	2400		2412	2406		2434	2446	
Interferer level (C/I dB)	-19.1	-17.6	-72.6	-19.1	-17.1	-72.6	-16.6	-17.1	
Interferer level (C/I dB)	-47.9	-49.4	5.6	-47.9	-49.9	5.6	-50.4	-49.9	
BLE 4.2 limit (C/I dB)	-27	-26	21	-27	-26	21	-27	-26	
Margin (dB)	20.9	23.4	15.4	20.9	23.9	15.4	23.4	23.9	

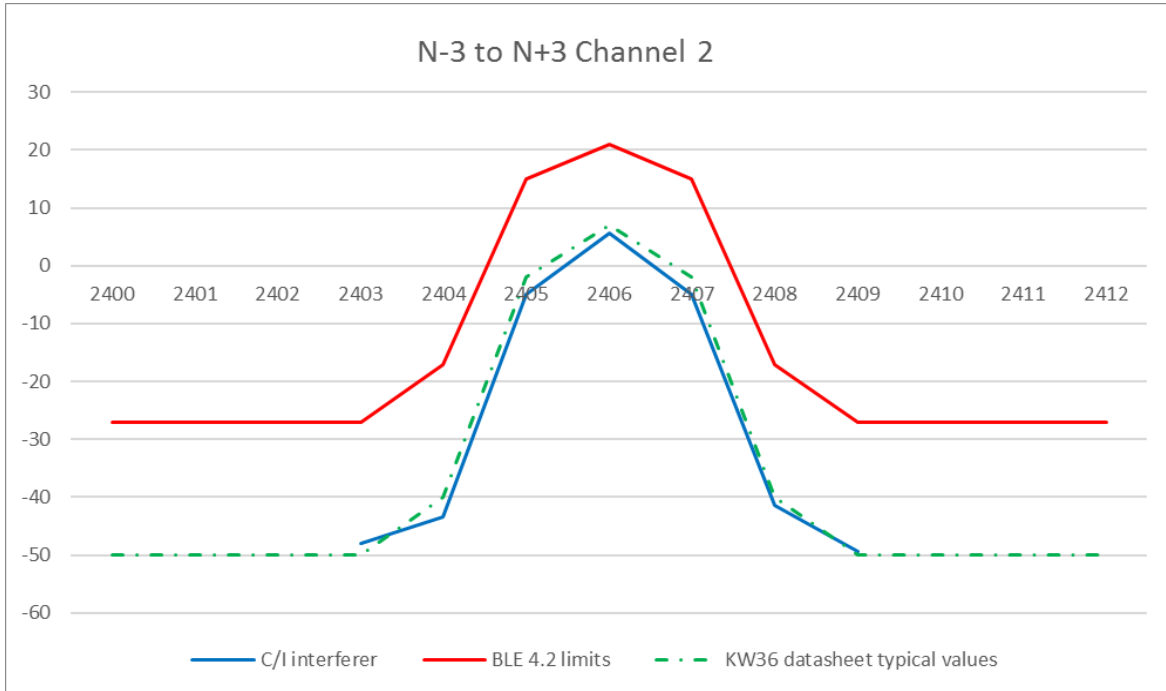

Figure 52. Adjacent, alternate, and co-channel rejection (channel 2)

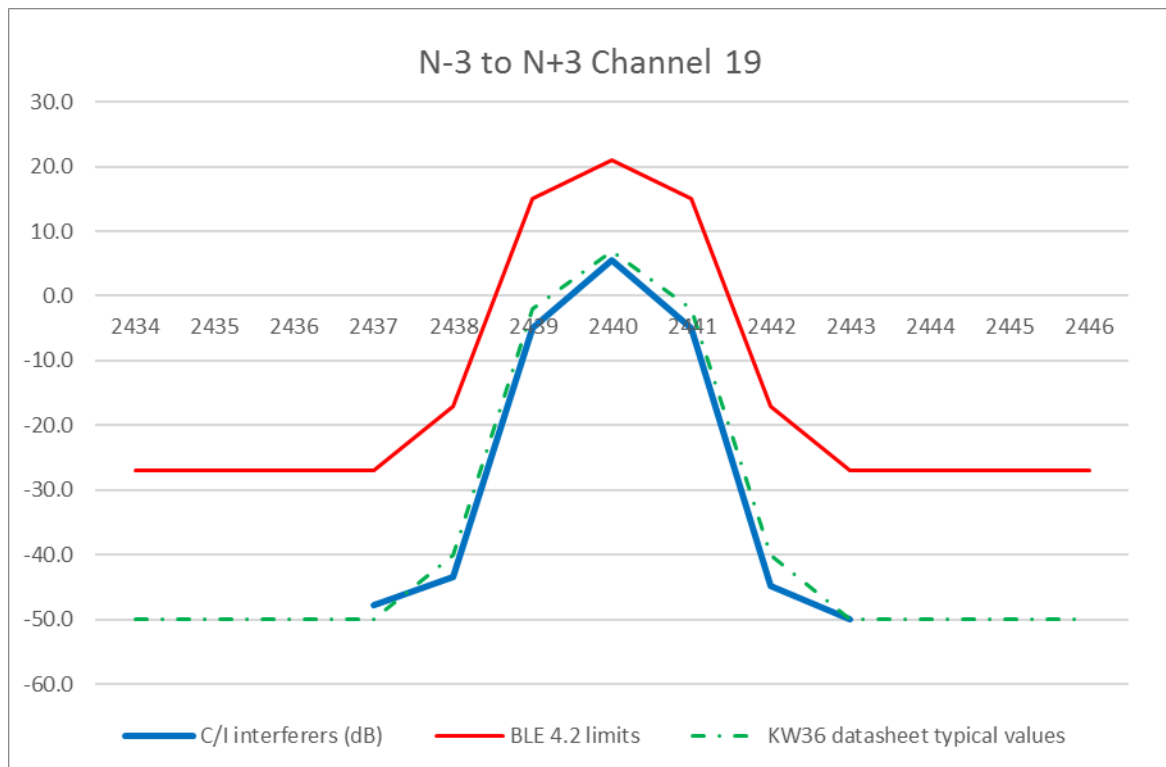

Figure 53. Adjacent, alternate, and co-channel rejection (channel 19)

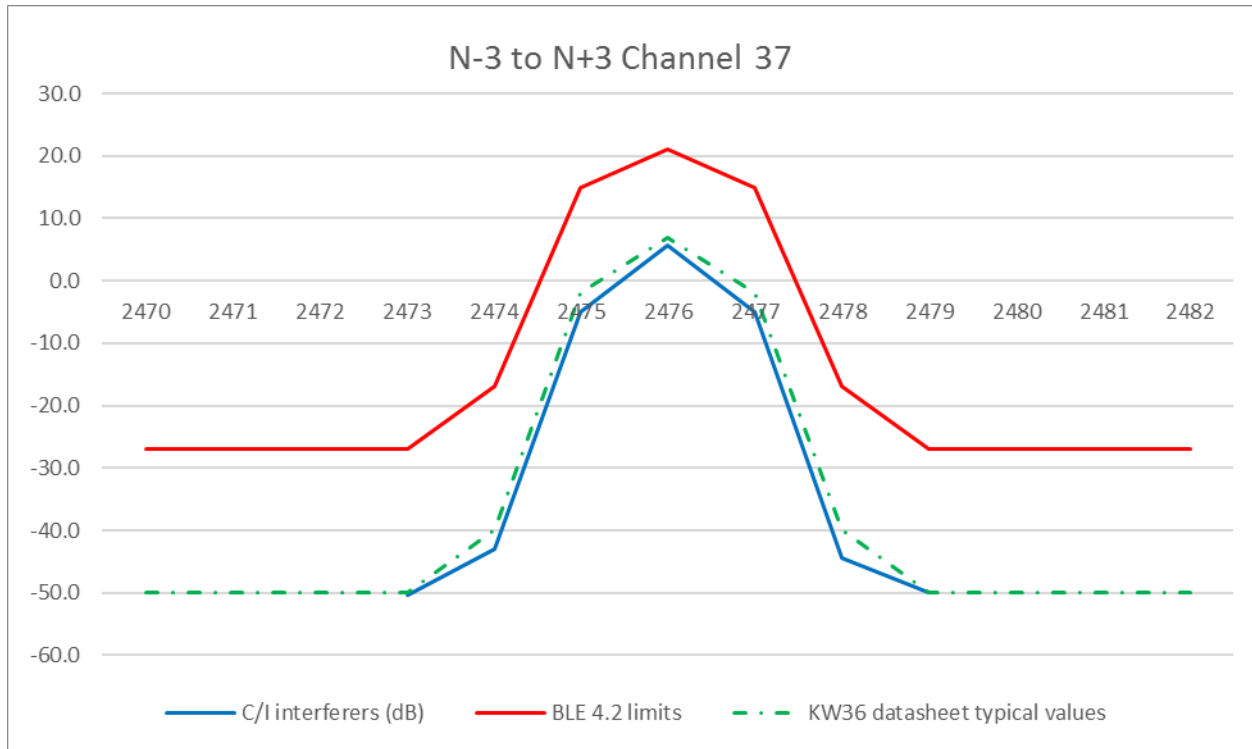

Figure 54. Adjacent, alternate, and co-channel rejection (channel 37)

Conclusion:

- Good margin, in line with the expected results

3.2.5.2. Receiver blocking

The blocking interferers are located at the out-of-band channels, depending on the receiver category.

Receiver category 1. (See the 300.328 2.1.1 chapter 4.3.1.12.4.2)

The test is performed with only one interfering signal at a time.

Test method:

- Generator for the desired signal: Agilent N5182A
- Generator for the interferers: R&S SFU
- Criterion: PER < 10 %
- The wanted signal is set to Pmin + 6 dB (-82 dBm); the interferer is increased until the PER threshold is reached
- Channels under test: 0 and 39

Result:

Table 11. Receiver blocking (out-of-band) rejection

	ch0	ch0	ch39	ch39		
	2402	2402	2480	2480		
	Low	High	Low	High		
	2380	2503.5	2380	2503.5		
Interferer level (dBm)	-16.1	-12.6	-13.6	-15.6		
BLE 4.2 limit (dBm)	-53	-53	-53	-53		
Margin (dB)	36.9	40.4	39.4	37.4		
	ch0	ch0	ch0	ch39	ch39	ch39
	2402	2402	2402	2480	2480	2480
	Low	Low	Low	Low	Low	Low
	2300	2330	2360	2300	2330	2360
Interferer level (dBm)	-12.6	-12.6	-14.6	-12.6	-12.6	-13.6
BLE 4.2 limit (dBm)	-47	-47	-47	-47	-47	-47
Margin (dB)	34.4	34.4	32.4	34.4	34.4	33.4
	ch0	ch0	ch0	ch0	ch0	ch0
	2402	2402	2402	2402	2402	2402
	High	High	High	High	High	High
	2523.5	2553.5	2583.5	2613.5	2643.5	2673.5
Interferer level (dBm)	-12.1	-12.1	-12.1	-12.1	-12.1	-12.1
BLE 4.2 limit (dBm)	-47	-47	-47	-47	-47	-47
Margin (dB)	34.9	34.9	34.9	34.9	34.9	34.9
	ch39	ch39	ch39	ch39	ch39	ch39
	2480	2480	2480	2480	2480	2480
	High	High	High	High	High	High
	2523.5	2553.5	2583.5	2613.5	2643.5	2673.5
Interferer level (dBm)	-14.1	-14.1	-14.1	-14.1	-14.1	-14.1
BLE 4.2 limit (dBm)	-47	-47	-47	-47	-47	-47
Margin (dB)	32.9	32.9	32.9	32.9	32.9	32.9

Conclusion:

- Good margin, in line with the expected results

Receiver category 2 (See the 300.328 2.1.1 chapter 4.3.1.12.4.3)

The test is performed with only one interfering signal at a time.

Test method:

- Generator for the desired signal: Agilent N5182A
- Generator for the interferers: R&S SFU
- Criterion: PER < 10 %
- The wanted signal is set to Pmin + 6 dB (-82 dBm); the interferer is increased until the PER threshold is reached
- Channels under test: 0 and 39

Result:

Table 12. Receiver blocking (out-of-band) rejection

	ch0	ch0	ch39	ch39
	2402	2402	2480	2480
	Low	Low	High	High
	2380	2503.5	2380	2503.5
Interferer level (dBm)	-16.6	-12.6	-14.1	-16.1
BLE 4.2 limit (dBm)	-57	-57	-57	-57
Margin (dB)	40.4	44.4	42.9	40.9

	ch0	ch0	ch39	ch39
	2402	2402	2480	2480
	Low	Low	High	High
	2300	2583.5	2300	2583.5
Interferer level (dBm)	-12.6	-12.6	-12.6	-12.6
BLE 4.2 limit (dBm)	-47	-47	-47	-47
Margin (dB)	34.4	34.4	34.4	34.4

Conclusion:

- Good margin, in line with the expected results

3.2.5.3. Blocking interferers

The CW is used as the interferer source to verify that the receiver performs satisfactorily for frequencies outside the 2400 MHz – 2483.5 MHz range.

Test method:

- Generator for the desired signal: Agilent N5182A
- Generator for the blocker: R&S SFU
- Criterion: PER < 30.8 % with 1500 packets
- The wanted signal is set to -67 dBm; the interferer level is increased until the PER threshold is reached
- Channel under test: 12 (2426 MHz)

Table 13. Blocking interferers

Wanted signal 2426 MHz @ -67 dBm	ch12 2426 MHz	ch12 2426 MHz	ch12 2426 MHz	ch12 2426 MHz
Interferer (MHz)	30-2000 (step 10 MHz)	2003 – 2399 (step 3 MHz)	2484 – 2997 (step 3 MHz)	3 GHz – 12.75 GHz (step 25 MHz)
Unwanted level (dBm)	-30	-35	-35	-30
Status (unwanted level)	PASS	PASS	PASS	PASS
Number of blocking fail	0	0	0	0
Status (UnW level -50 dBm)	PASS	PASS	PASS	PASS
Number of blocking fail	0	0	0	0

Fail blockers must not exceed 10

Fail blockers must not exceed 3

Conclusion:

- Good margin, in line with the expected results

3.2.6. Intermodulation

This test verifies whether the receiver intermodulation performance is satisfactory.

Two interferers are used in combination with the wanted signal. One interferer is a sinusoid non-modulated signal and the second interferer is a modulated signal with the PRBS15 data.

Test method:

- Generator for the desired signal: Agilent N5182A
- Generator for the first interferer (CW): R&S SML03
- Generator for the second interferer (PRBS15): R&S SFU
- Criterion: PER < 30.8 % with 1500 packets
- The wanted signal is set to -67 dBm; the interferer levels are set to the datasheet specification values
- Channels under test: 0, 19, and 39

Results:

Table 14. Intermodulation

	ch0	ch0	ch0	ch0	ch0	ch0
	2402	2402	2402	2402	2402	2402
	Low	Low	Low	Low	Low	Low
Interferer1 (CW) (MHz)	-5	-4	-3	3	4	5
Interferer2 (Mod) (MHz)	-10	-8	-6	6	8	10
Interferer level (dBm)	-25.7	-26.2	-28.2	-27.2	-27.2	-29.2
300.328 limit (dBm)	-35	-38.5	-42	-42	-38.5	-35
Margin (dB)	17.0	20.0	21.5	22.5	19.0	13.5
	ch19	ch19	ch19	ch19	ch19	ch19
	2440	2440	2440	2440	2440	2440
	Mid	Mid	Mid	Mid	Mid	Mid
Interferer1 (CW) (MHz)	-5	-4	-3	3	4	5
Interferer2 (Mod) (MHz)	-10	-8	-6	6	8	10
Interferer level (dBm)	-26.2	-27.2	-27.2	-29.2	-28.7	-28.2
300.328 limit (dBm)	-35	-38.5	-42	-42	-38.5	-35
Margin (dB)	16.5	19.0	22.5	20.5	17.5	14.5
	ch39	ch39	ch39	ch39	ch39	ch39
	2480	2480	2480	2480	2480	2480
	High	High	High	High	High	High
Interferer1 (CW) (MHz)	-5	-4	-3	3	4	5
Interferer2 (Mod) (MHz)	-10	-8	-6	6	8	10
Interferer level (dBm)	-29.2	-28.2	-28.7	-29.7	-28.7	-29.2
300.328 limit (dBm)	-35	-38.5	-42	-42	-38.5	-35
Margin (dB)	13.5	18.0	21.0	20.0	17.5	13.5

Conclusion:

- Good margin, in line with the expected results

3.3. Return loss

The FRDM-KW36 RF circuit provides an RF interface for users to begin application development. A minimum matching network to the MCU antenna pin is provided through C50, C51, and L2 to match the printed F-antenna to a 50 Ω controlled line.

CAUTION

The RF matching is different depending of the RF output power targeted. If the maximum RF output power is lower than +3.5 dBm, 2 components are recommended. This is the default mounting component on the FRDM-KW36.

If the maximum RF output power is between +3.5 dBm and +5 dBm, it is recommended to use three components for the RF matching.

Maximum RF output power $\leq +3.5$ dBm	2 components RF matching C50=0.8 pF, L2=4.7 nH, C51=DNP See Figure 52.
+3.5dBm < Maximum RF output power $\leq +5$ dBm	3 components RF matching C50=0.6 pF, L2=4.7 nH, C51=0.3 pF Refer to Figure 53.

3.3.1. RF path with two matching components

The measurements are done using the SMA connector. Therefore, the C57 capacitor is mounted and the C55 capacitor is not mounted.

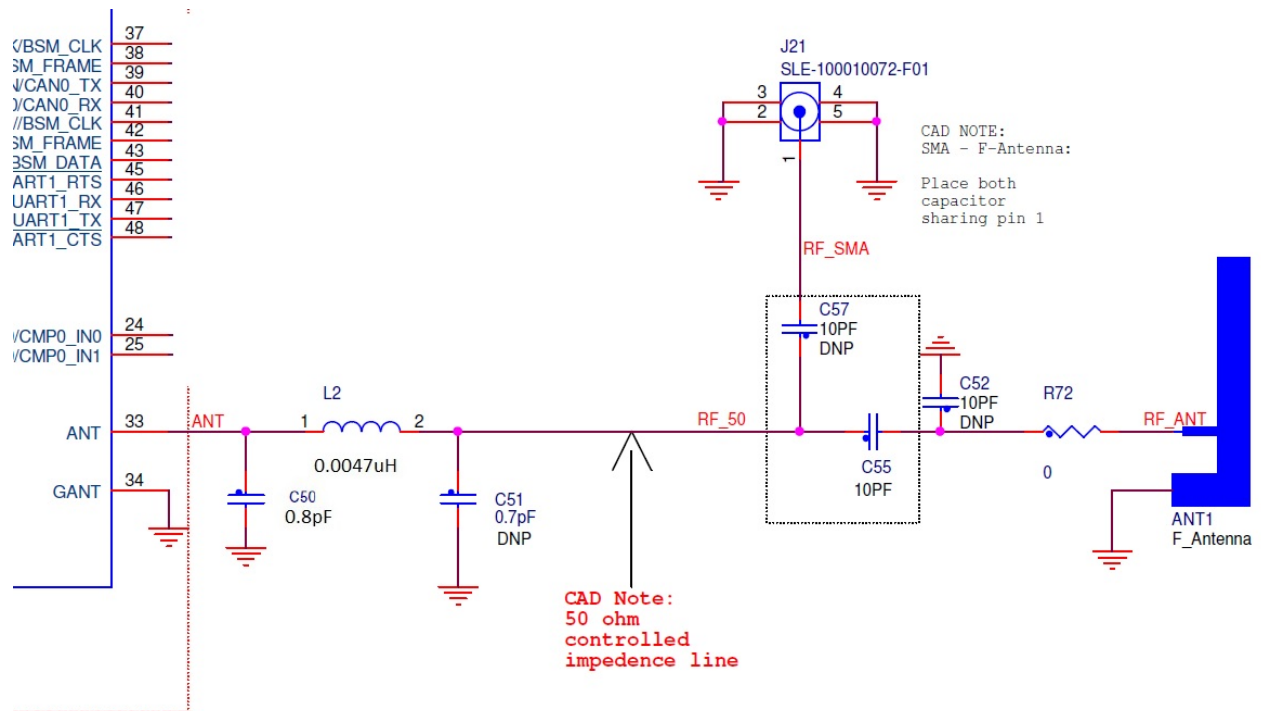

Figure 55. RF matching with two components

Conducted tests

The matching components are:

- $L2 = 4.7 \text{ nH}$

Description	Mfr. name	Mfr. part number
IND -- 0.0047 μH @ 500 MHz 300 mA +/-0.1 nH 0402	MURATA	LQG15HH4N7S02D

- $C50 = 0.8 \text{ pF}$

Description	Mfr. name	Mfr. part number
CAP CER 0.8 pF 50 V 0.1 pF C0G 0402	MURATA	GCM1555C1HR80BA16

3.3.2. RF path with three matching components

The measurements are done using the SMA connector. Therefore, the C57 capacitor is mounted and the C55 capacitor is not mounted.

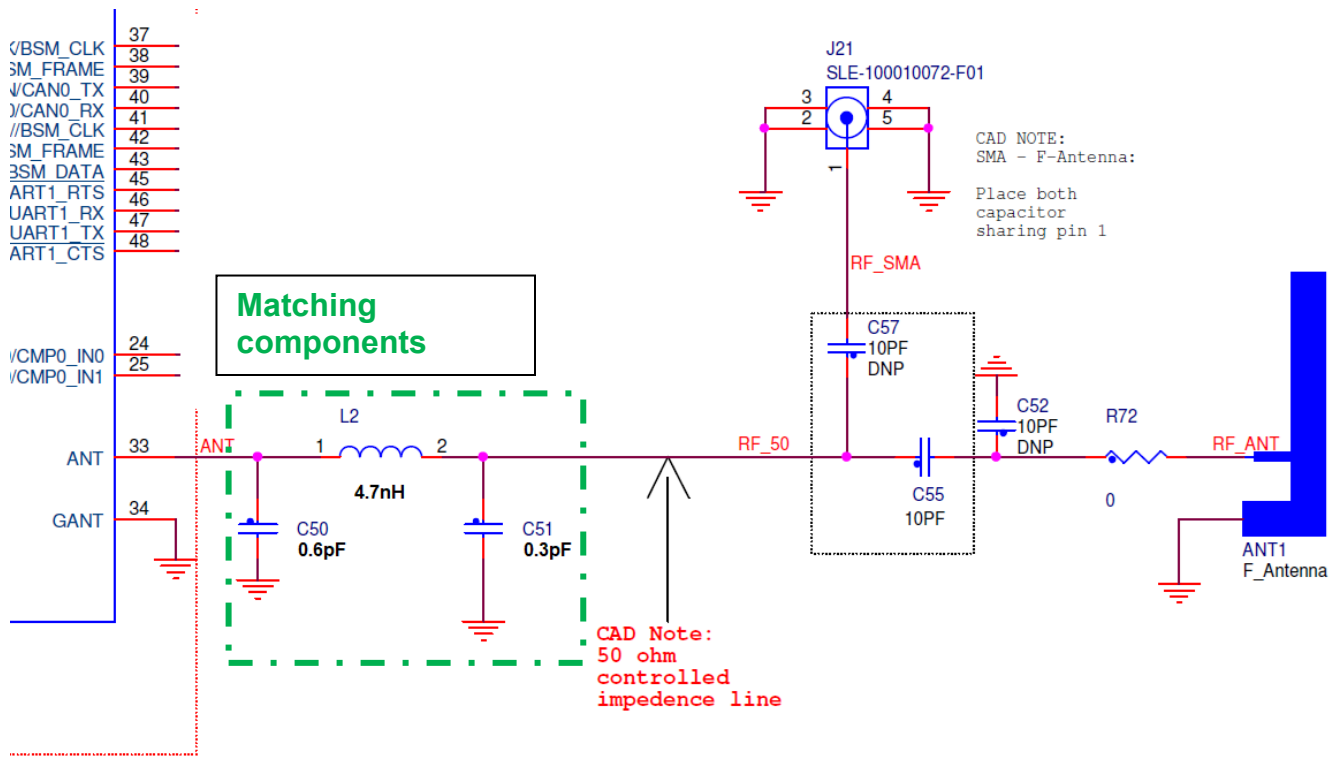

Figure 56. RF matching with three components

The matching components are:

- $L2 = 4.7 \text{ nH}$

Description	Mfr. name	Mfr. part number
IND -- 0.0047 μH @ 500 MHz 300 mA +/-0.1 nH 0402	MURATA	LQG15HH4N7S02D

- $C50 = 0.6 \text{ pF}$

Description	Mfr. name	Mfr. part number
CAP CER 0.6 pF 50 V 0.1 pF C0G 0402	MURATA	GCM1555C1HR60BA16

- $C51 = 0.3 \text{ pF}$

Description	Mfr. name	Mfr. part number
CAP CER 0.3 pF 50 V 0.1 pF C0G 0402	MURATA	GCM1555C1HR30BA16

3.3.3. RX with two components

NOTE

In the Rx mode, the return loss measurement is performed by setting the LNA gain of the KW36Z to the maximum.

Hardware: FRDM-KW36

10/2/2017 4:38:54 PM
1328.5170K92-100760-Pp

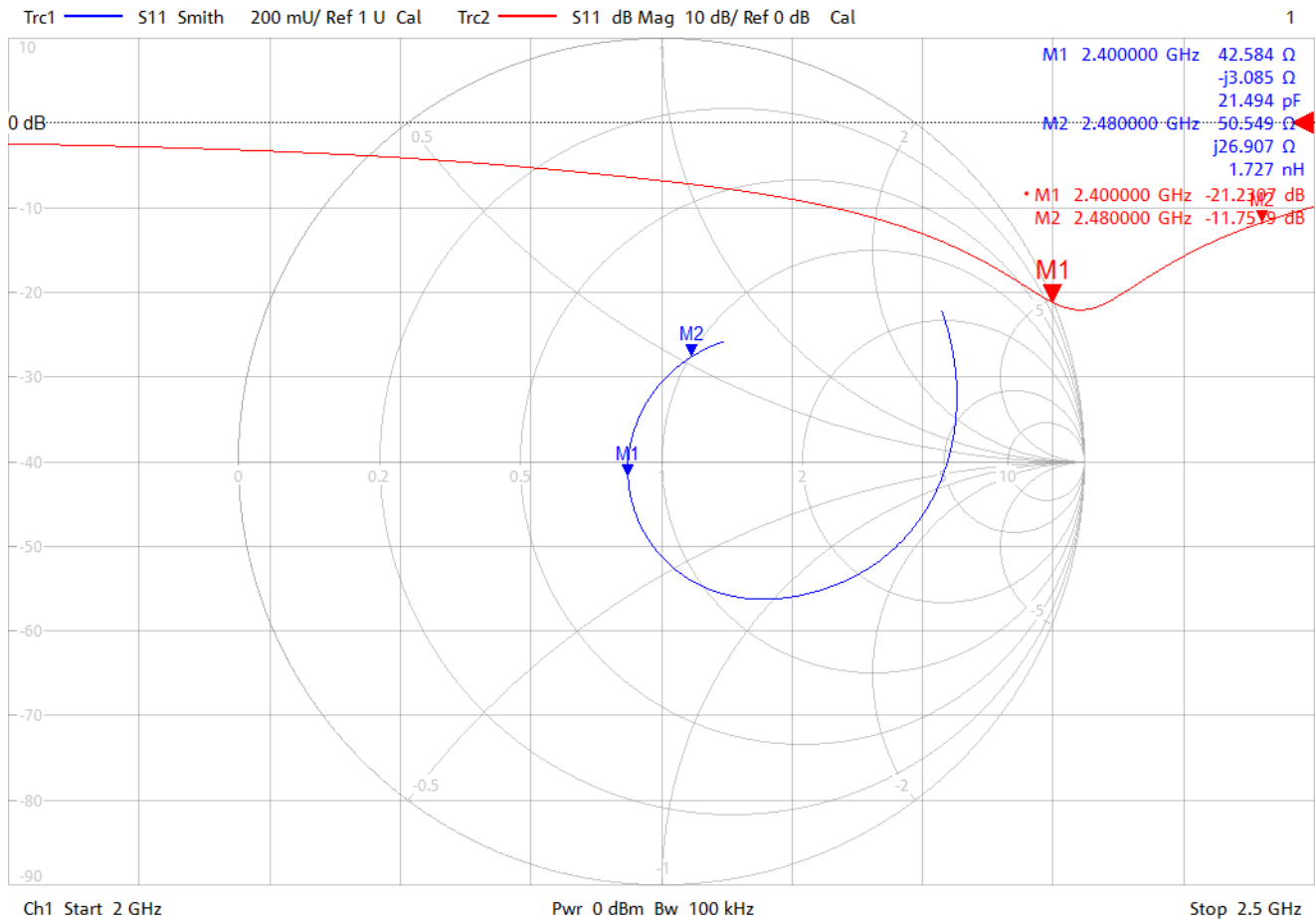

Figure 57. S11 diagram (Rx mode)

Results:

- Return loss: -21.2 dB (2.4 GHz) < S11 < -11.7 dB (2.48 GHz)

NOTE

There is no specification for the return loss.

Conclusion:

- The return loss (S11) is lower than -10 dB

3.3.4. TX with two components

NOTE

In the Tx mode, the return loss measurement is performed by setting the KW36Z RF output power to the minimum.

Hardware: FRDM-KW36

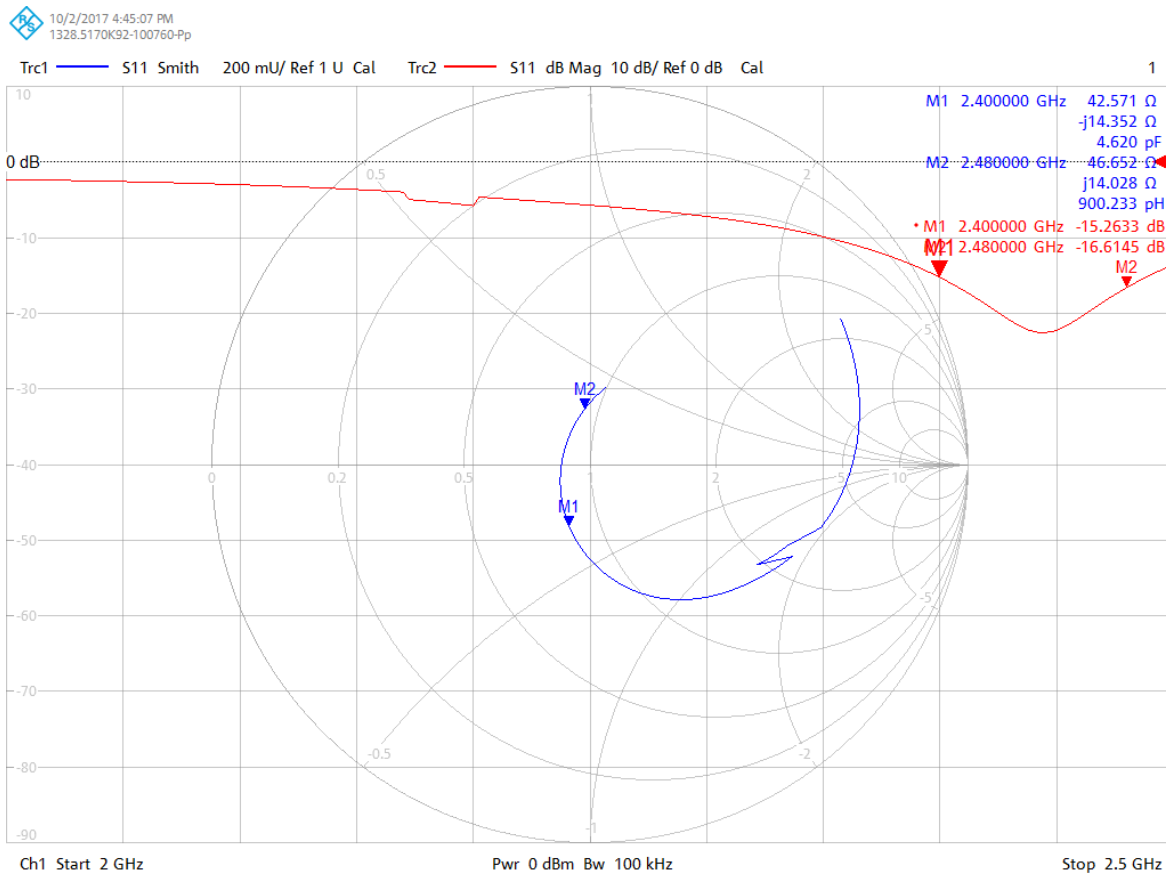

Figure 58. S11 diagram (Tx mode)

Results:

- Return loss: -16.6 dBm (2.48 GHz) < S11 < -15.2 dB (2.4 GHz)

NOTE

There is no specification for the return loss.

Conclusion:

- The return loss (S11) is lower than -10 dB

3.3.5. RX with three components

NOTE

In the Rx mode, the return loss measurement is performed by setting the LNA gain of the KW36Z to the maximum.

Hardware: FRDM-KW36

11/20/2019 4:48:04 PM
1328.5170K92-100760-Pp

Trc1 — S11 Smith 200 mU/ Ref 1 U Cal

1

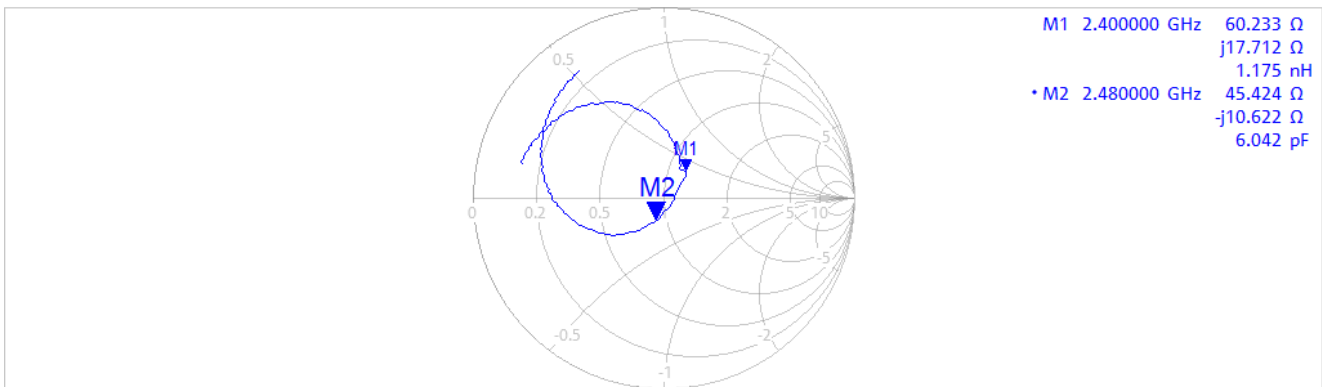

Ch1 Start 2 GHz

Pwr -45 dBm Bw 10 kHz

Stop 3 GHz

Trc2 — S11 dB Mag 5 dB/ Ref -20 dB Cal

2

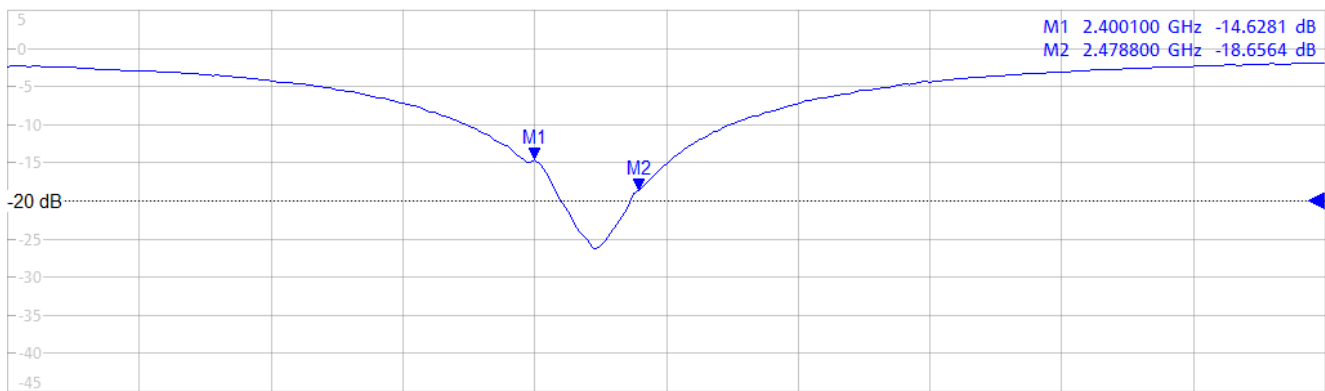

Ch1 Start 2 GHz

Pwr -45 dBm Bw 10 kHz

Stop 3 GHz

Figure 59. S11 diagram (Rx mode)

Results:

- Return loss: -18.6 dB (2.48 GHz) < S11 < -14.6 dB (2.4 GHz)

NOTE

There is no specification for the return loss.

Conclusion:

- The return loss (S11) is lower than -10 dB

3.3.6. TX with three components

NOTE

In the Tx mode, the return loss measurement is performed by setting the KW36Z RF output power to the minimum.

Hardware: FRDM-KW36

11/20/2019 4:48:58 PM
1328.5170K92-100760-Pp

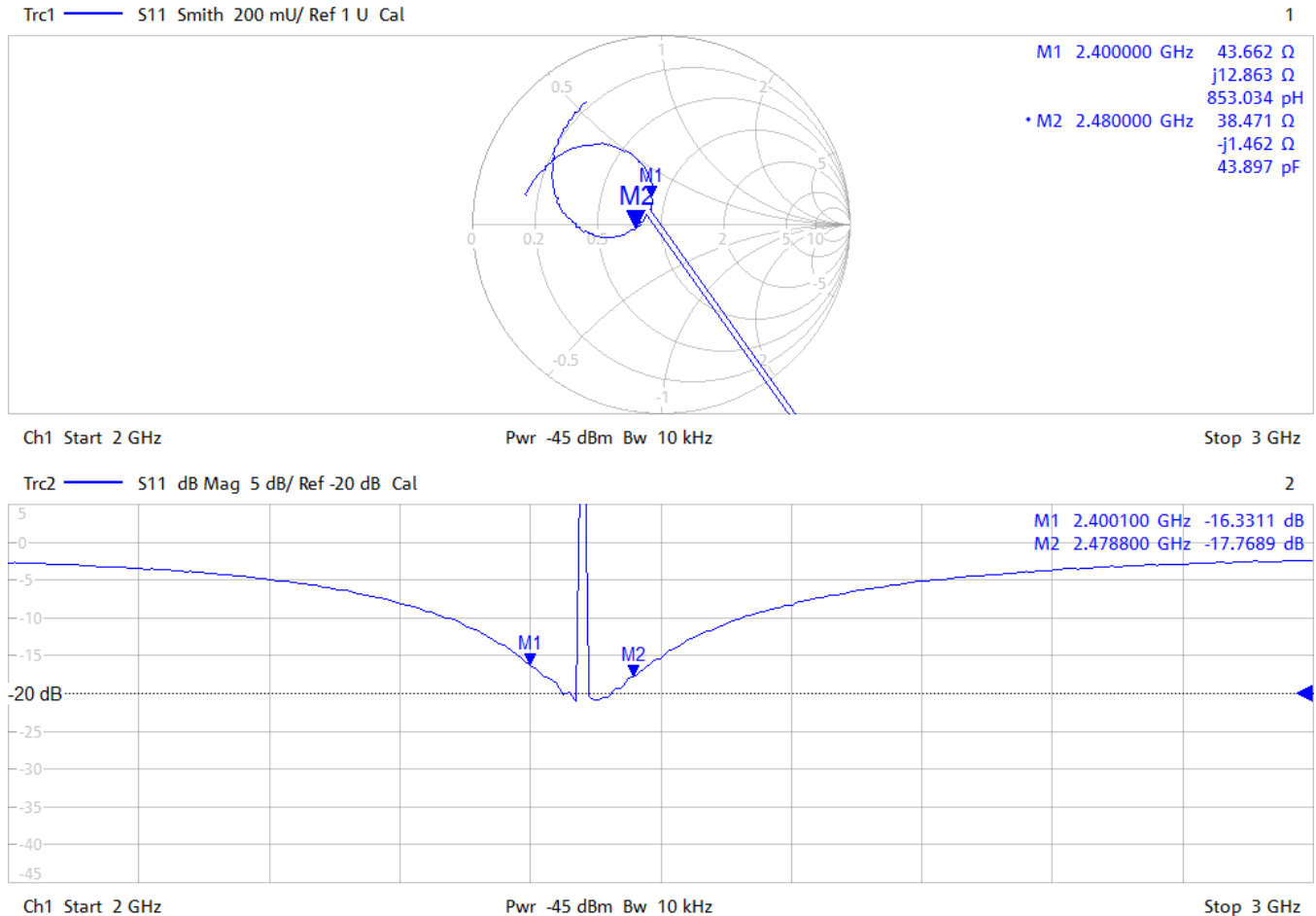

Figure 60. S11 diagram (Tx mode)

Results:

- Return loss: -17.7 dBm (2.48 GHz) < S11 < -16.3 dB (2.4 GHz)

NOTE

There is no specification for the return loss.

Conclusion:

- The return loss (S11) is lower than -10 dB

4. Radiated tests

4.1. RX test setup

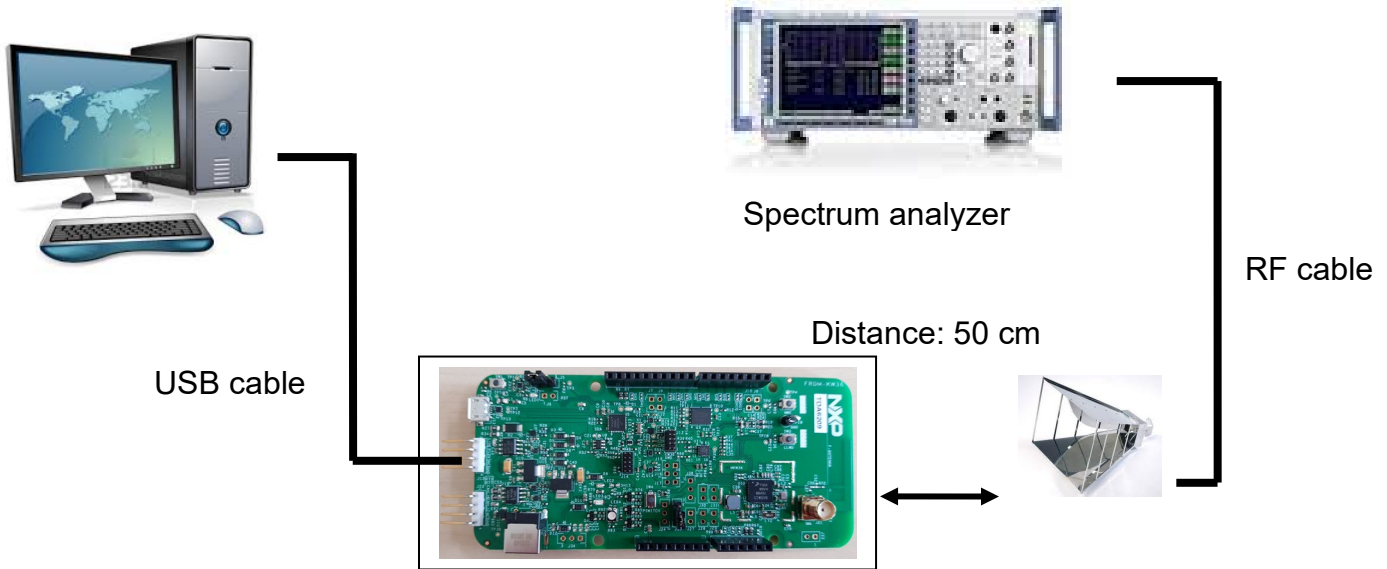

Figure 61. Radiated RX test setup

During the radiated measurements, only the printed antenna (IFA type) is considered. A receiver antenna with a known gain is placed 50 cm from the FRDM-KW36Z antenna. The receiver antenna (horn) is connected to the spectrum analyzer. The RX signal is measured in the same way as in the conducted measurements.

4.2. RX spurious

Test method:

- Set the radio to:
 - Receiver mode, frequency: channel 19
- Set the analyzer to:
 - Ref amp = - 20 dBm, Trace = max hold, detector = max peak
 - Start/stop frequency: 10 MHz/1 GHz
 - RBW = 100 kHz
 - Set the start/stop frequency: 1 GHz/30 GHz
 - RBW = 1 MHz

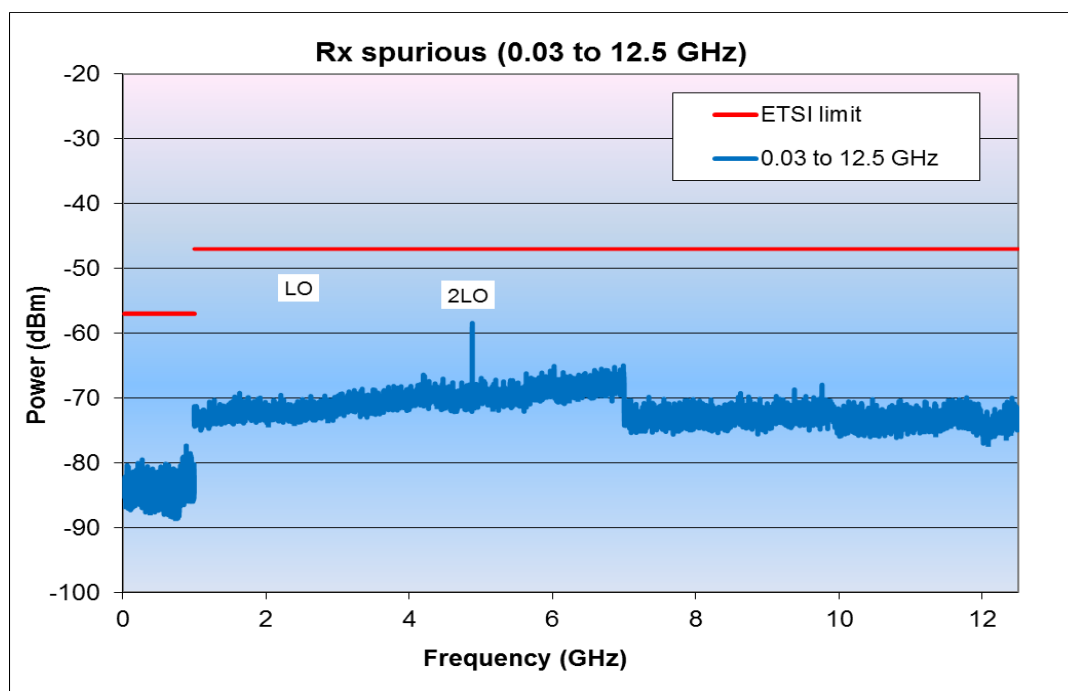

Figure 62. Conducted RX spurious 30 MHz – 12.5 GHz

Conclusion:

- There are no spurs above the spectrum analyzer noise floor except for the 2xLO frequency which is under the ETSI limit with a 19-dB margin (conducted mode)
- In the radiated mode, the 2xLO is significant and the margin falls to 0 dBm

NOTE

It is recommended to copy-paste the RF part of the FRDM-KW36Z layout strictly.

- The recommendation to decrease the 2xLO leakage is in the *Hardware Design Considerations for MKW35A/36A/35Z/36Z Bluetooth LE Devices*.

5. Antenna measurements

5.1. Return loss

To measure the return loss of the antenna (S11), disconnect the C55 and C57 capacitors and make a connection marked by the green line in Figure 37 (antenna link to the SMA).

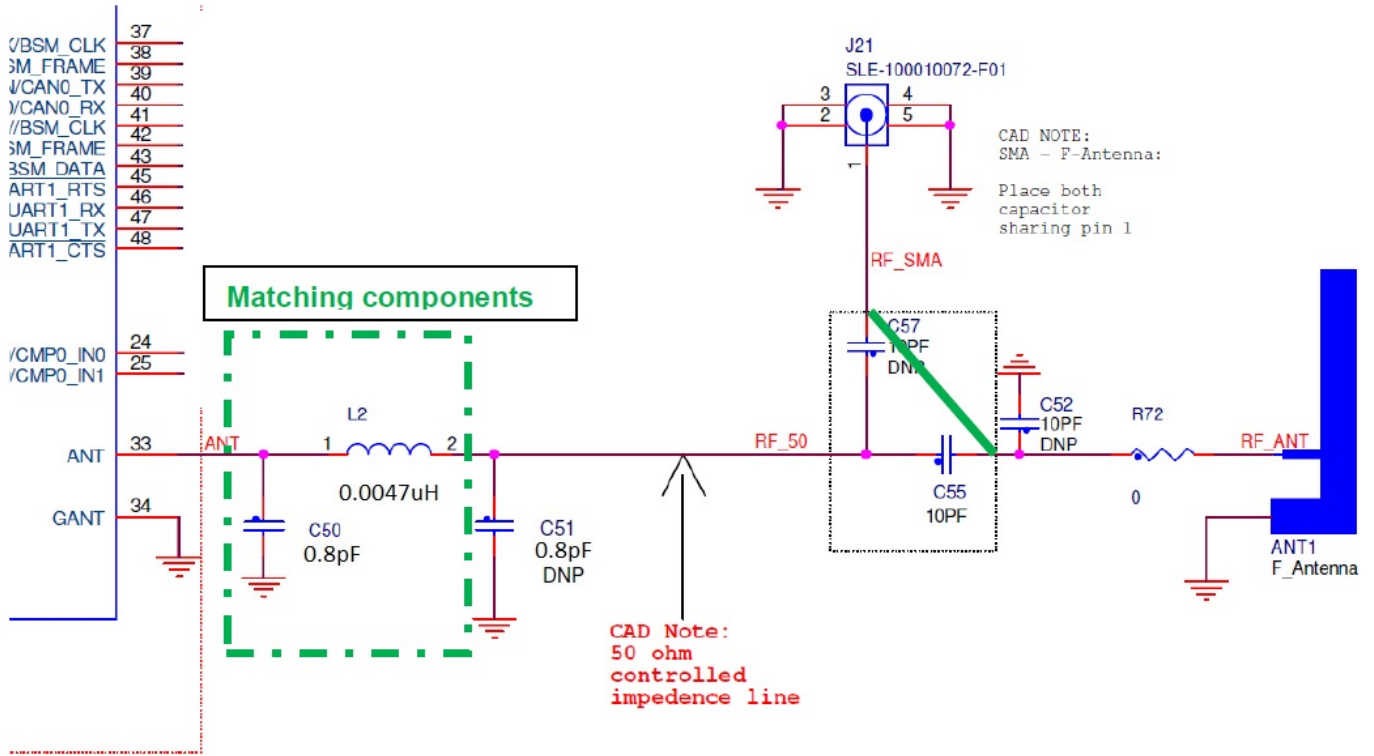

Figure 63. RF path connection (S11 antenna)

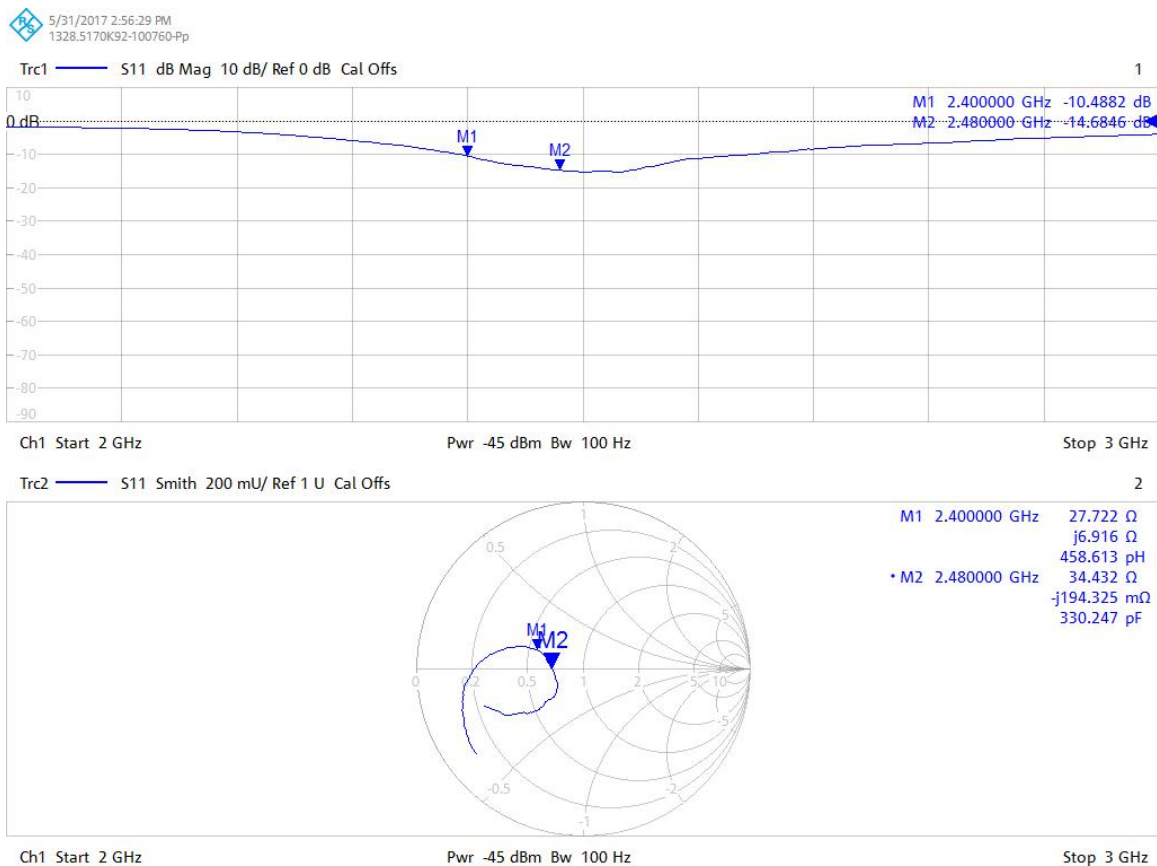

Figure 64. Antenna return loss (S11)

Results:

- Return loss: -10.5 (2.4 GHz) $< S_{11} < -14.7$ dB (2.48 GHz)

NOTE

There is no specification for the return loss.

Conclusion:

- The return loss (S11) is lower than -10 dB

6. Conclusion

Beyond the RED and Bluetooth LE 4.2 compliances, these radio tests prove a good performance of the KW36Z wireless MCU.

7. References

- **ETS EN 300 328:** European Telecommunication Standard—Radio Equipment and Systems (RES) Wideband data transmission systems, Technical characteristics and test conditions for data transmission equipment operating in the 2.4-GHz ISM band and using spread spectrum modulation techniques.
- **RF-PHY TS 4.2.0:** Bluetooth Test Specification. This document defines test structures and procedures for qualification testing of Bluetooth implementations of the Bluetooth Low Energy RF PHY.
- **FCC Part 15:** Operation to FCC Part 15 is subject to two conditions. Firstly, the device may not cause harmful interference and, secondly, the device must accept any interference received, including interference that may cause undesired operation. Hence, there is no guaranteed quality of service when operating a Part 15 device.

8. Revision history

Table summarizes the changes done to this document since the initial release.

Table 15. Revision history

Revision number	Date	Substantive changes
0	11/2017	Initial release.
1	03/2018	Added Section 3.1.7 , "Upper band edge".
2	09/2018	Updated the references to Bluetooth LE.
3	08/2019	Updated Table 11 and Table 12 .
4	01/2020	Added the +5 dBm measurement results.
5	12/2020	Updated Section 3.2.2.1 , "With the ARB generator".

How to Reach Us:

Home Page:

nxp.com

Web Support:

nxp.com/support

Information in this document is provided solely to enable system and software implementers to use NXP products. There are no express or implied copyright licenses granted hereunder to design or fabricate any integrated circuits based on the information in this document. NXP reserves the right to make changes without further notice to any products herein.

NXP makes no warranty, representation, or guarantee regarding the suitability of its products for any particular purpose, nor does NXP assume any liability arising out of the application or use of any product or circuit, and specifically disclaims any and all liability, including without limitation consequential or incidental damages. "Typical" parameters that may be provided in NXP data sheets and/or specifications can and do vary in different applications, and actual performance may vary over time. All operating parameters, including "typicals," must be validated for each customer application by customer's technical experts. NXP does not convey any license under its patent rights nor the rights of others. NXP sells products pursuant to standard terms and conditions of sale, which can be found at the following address:

www.nxp.com/SalesTermsandConditions.

While NXP has implemented advanced security features, all products may be subject to unidentified vulnerabilities. Customers are responsible for the design and operation of their applications and products to reduce the effect of these vulnerabilities on customer's applications and products, and NXP accepts no liability for any vulnerability that is discovered. Customers should implement appropriate design and operating safeguards to minimize the risks associated with their applications and products.

NXP, the NXP logo, NXP SECURE CONNECTIONS FOR A SMARTER WORLD, COOLFLUX, EMBRACE, GREENCHIP, HITAG, I2C BUS, ICODE, JCOP, LIFE VIBES, MIFARE, MIFARE CLASSIC, MIFARE DESFire, MIFARE PLUS, MIFARE FLEX, MANTIS, MIFARE ULTRALIGHT, MIFARE4MOBILE, MIGLO, NTAG, ROADLINK, SMARTLX, SMARTMX, STARPLUG, TOPFET, TRENCHMOS, UCODE, Freescale, the Freescale logo, Altivec, C 5, CodeTEST, CodeWarrior, ColdFire, ColdFire+, C Ware, the Energy Efficient Solutions logo, Kinetis, Layerscape, MagniV, mobileGT, PEG, PowerQUICC, Processor Expert, QorIQ, QorIQ Qonverge, Ready Play, SafeAssure, the SafeAssure logo, StarCore, Symphony, VortiQa, Vybrid, Airfast, BeeKit, BeeStack, CoreNet, Flexis, MXC, Platform in a Package, QUICC Engine, SMARTMOS, Tower, TurboLink, and UMEMS are trademarks of NXP B.V. All other product or service names are the property of their respective owners. Arm, AMBA, Arm Powered, Artisan, Cortex, Jazelle, Keil, SecurCore, Thumb, TrustZone, and μ Vision are registered trademarks of Arm Limited (or its subsidiaries) in the EU and/or elsewhere. Arm7, Arm9, Arm11, big.LITTLE, CoreLink, CoreSight, DesignStart, Mali, Mbed, NEON, POP, Sensinode, Socrates, ULINK and Versatile are trademarks of Arm Limited (or its subsidiaries) in the EU and/or elsewhere. All rights reserved. Oracle and Java are registered trademarks of Oracle and/or its affiliates. The Power Architecture and Power.org word marks and the Power and Power.org logos and related marks are trademarks and service marks licensed by Power.org.

© 2020 NXP B.V.

Document Number: AN12076
Rev. 5
12/2020



X-ON Electronics

Largest Supplier of Electrical and Electronic Components

Click to view similar products for [Bluetooth Development Tools - 802.15.1 category](#):

Click to view products by [NXP manufacturer](#):

Other Similar products are found below :

[DA14580PRODTLKT](#) [1628](#) [SP14808ST](#) [MBH7BLZ02-EF-KIT](#) [CYBLE-014008-PROG](#) [FWM7BLZ20-EB-KIT](#) [SP14801-DUT](#)
[ATSAMB11ZR-XPRO](#) [SKY66111-21EK1](#) [SECO-RSL10-TAG-GEVB](#) [ENW89857AXKF](#) [3026](#) [MIKROE-2471](#) [MOD-NRF8001](#) [BLE-IOT-GEVB](#) [450-0184](#) [EKSHCNZXZ](#) [EVAL_PAN1026](#) [EVAL_PAN1720](#) [EVAL_PAN1740](#) [2267](#) [2479](#) [2487](#) [2633](#) [STEVAL-IDB005V1D](#)
[STEVAL-IDB001V1](#) [MIKROE-2545](#) [SIPKITSLF001](#) [2995](#) [STEVAL-IDB007V1M](#) [2829](#) [DFR0267](#) [DFR0296](#) [DFR0492](#) [TEL0073](#) [BM-70-CDB](#) [WSM-BL241-ADA-008DK](#) [STEVAL-BTDP1](#) [ACD52832](#) [TEL0095](#) [ISP1507-AX-TB](#) [RN-4871-PICTAIL](#) [DA14695-00HQDEVKT-P](#)
[DA14695-00HQDEVKT-U](#) [EVK-NINA-B112](#) [EBSHJNZXZ](#) [EKSGJNZWY](#) [EKSHJNZXZ](#) [BMD-200-EVAL-S](#) [ACN BREAKOUT BOARD](#)