

KITMPC5643DBEVM Evaluation Daughter Board

Featuring the Qorivva MPC5643L 32-bit Microcontroller

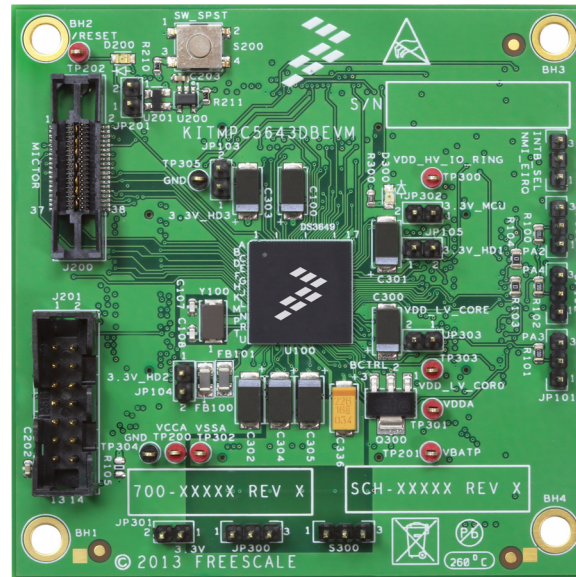

Figure 1. KITMPC5643DBEVM Evaluation Board

Contents

1 Kit Contents/Packing List	2
2 Jump Start	2
3 Important Notice	3
4 Introduction	4
5 Evaluation Board Features	5
6 MPC5643L Device Features	5
7 Required Equipment	6
8 Evaluation Board Configuration	7
9 Setting Up and Using the Hardware	9
10 Evaluation Board Hardware Description	10
11 Interfacing with the Mother Board	16
12 Schematic	19
13 Board Layout	22
14 Bill of Materials	30
15 References	32
16 Revision History	33

1 Kit Contents/Packing List

- Assembled and tested evaluation board/module in anti-static bag.
- Warranty card
- The board is preloaded with demo software

2 Jump Start

- Go to www.freescale.com/analogtools
- Locate your kit
- Review your Tool Summary Page
- Look for



- Download documents, software, and other information

3 Important Notice

Freescale provides the enclosed product(s) under the following conditions:

This evaluation kit is intended for use of ENGINEERING DEVELOPMENT OR EVALUATION PURPOSES ONLY. It is provided as a sample IC pre-soldered to a printed circuit board to make it easier to access inputs, outputs, and supply terminals. This evaluation board may be used with any development system or other source of I/O signals by simply connecting it to the host MCU or computer board via off-the-shelf cables. This evaluation board is not a Reference Design and is not intended to represent a final design recommendation for any particular application. Final device in an application will be heavily dependent on proper printed circuit board layout and heat sinking design as well as attention to supply filtering, transient suppression, and I/O signal quality.

The goods provided may not be complete in terms of required design, marketing, and or manufacturing related protective considerations, including product safety measures typically found in the end product incorporating the goods. Due to the open construction of the product, it is the user's responsibility to take any and all appropriate precautions with regard to electrostatic discharge. In order to minimize risks associated with the customers applications, adequate design and operating safeguards must be provided by the customer to minimize inherent or procedural hazards. For any safety concerns, contact Freescale sales and technical support services.

Should this evaluation kit not meet the specifications indicated in the kit, it may be returned within 30 days from the date of delivery and will be replaced by a new kit.

Freescale reserves the right to make changes without further notice to any products herein. Freescale makes no warranty, representation or guarantee regarding the suitability of its products for any particular purpose, nor does Freescale assume any liability arising out of the application or use of any product or circuit, and specifically disclaims any and all liability, including without limitation consequential or incidental damages. "Typical" parameters can and do vary in different applications and actual performance may vary over time. All operating parameters, including "Typical", must be validated for each customer application by customer's technical experts.

Freescale does not convey any license under its patent rights nor the rights of others. Freescale products are not designed, intended, or authorized for use as components in systems intended for surgical implant into the body, or other applications intended to support or sustain life, or for any other application in which the failure of the Freescale product could create a situation where personal injury or death may occur.

Should the Buyer purchase or use Freescale products for any such unintended or unauthorized application, the Buyer shall indemnify and hold Freescale and its officers, employees, subsidiaries, affiliates, and distributors harmless against all claims, costs, damages, and expenses, and reasonable attorney fees arising out of, directly or indirectly, any claim of personal injury or death associated with such unintended or unauthorized use, even if such claim alleges that Freescale was negligent regarding the design or manufacture of the part. Freescale™ and the Freescale logo are trademarks of Freescale Semiconductor, Inc. All other product or service names are the property of their respective owners.

© Freescale Semiconductor, Inc. 2014

4 Introduction

The KITMPC5643DBEVM evaluation board is populated with a MPC5643L safety oriented microcontroller from the Qorivva family. The KITMPC5643DBEVM is a daughter board that extends the KIT33908MBEVBE kit (populated with MC33908 System Basis chip). Together, these two kits create a platform that forms a base for a Safety Ecosystem, which can reach the highest level in functional safety as defined by the ISO26262. The whole platform is shown in [Figure 2](#).

The daughter board includes the MCU and external components necessary for its basic operation as the decoupling capacitors, crystal oscillator, reset circuitry, LED indicators, etc. Power supply and intelligent power management including enhanced safety features is provided to the daughter board from the mother board. Due to this, the daughter board cannot operate separately and it has to be plugged on the mother board (using four 80-pin connectors).

The daughter board is delivered with a demo software already loaded in the Flash memory of the MPC5643L. This code provides algorithms and procedures necessary to initialize and operate the MC33908 correctly. See the KTMPC5643DBSWUG - Basic SW Drivers for MPC5643L and the KTMPC5643DBDEMOUG – MC33908 Driver and Demo SW for details.

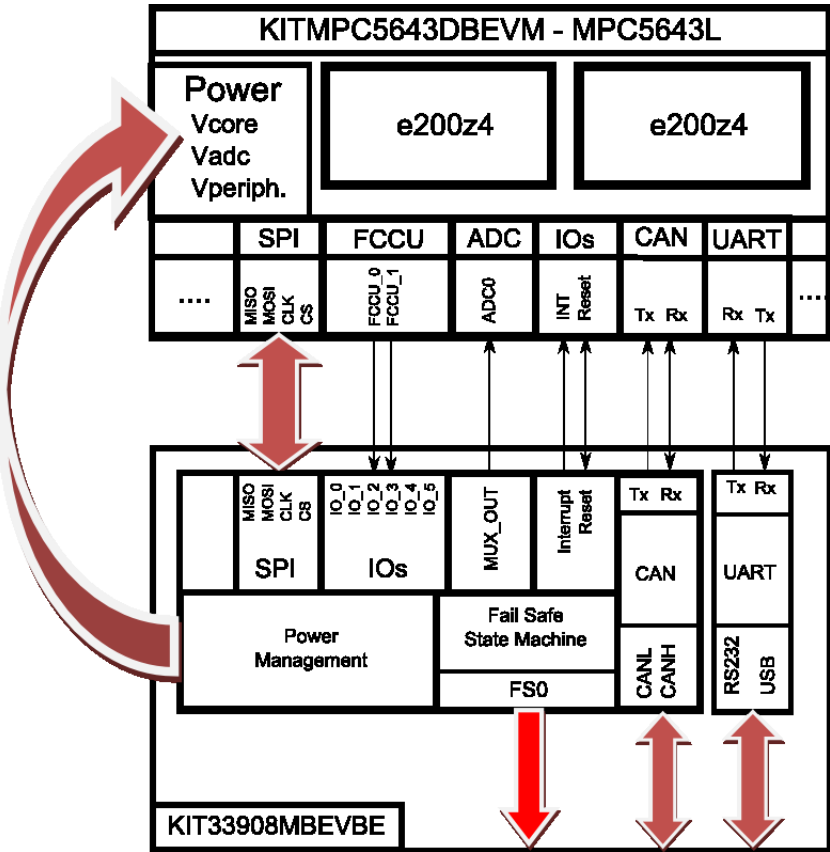

Figure 2. Interfacing with the KIT33908MBEVBE

5 Evaluation Board Features

- Qorivva MPC5643L 32-bit microcontroller with safety architecture
- Preloaded software demo for the MC33908 and MPC5643L platform
- Designed to be plugged onto the KIT33908MBEVBE Evaluation Board
- Separated power supplies for the core and the ADC
- High precision V_{CCA} power supply connected to the ADC reference voltage
- Equipped by Nexus and JTAG for simple Debug
- Possible to connect USB/RS232 through the mother board

6 MPC5643L Device Features

The SMARTMOS MPC5643L series of 32-bit Qorivva microcontrollers are system-on-chip devices that are built on Power Architecture® technology and contain enhancements that improve the architecture's fit in embedded applications. This includes an additional instruction support for digital signal processing (DSP) and integrated technologies, such as an enhanced time processor unit, enhanced queued analog-to-digital converter, Controller Area Network, and an enhanced modular input-output system. The device supports the following functions:

- Dual e200 Z4 CPU architecture
- Dual processing spheres including; CPU, DMA, interrupt controller, crossbar and MPU for logic level fault detection
- Two statically configurable modes of operation: Lockstep operation (redundant processing and calculations) and dual parallel mode (independent core operation)
- Fault collection unit, which monitors and manages fault events
- Error correction coding on RAM and flash memory allows detection/correction of memory errors
- First MCU to achieve ISO 26262 functional safety standard certification
- Robust communications with FlexRay™ and CAN/safety port high-speed low latency messaging
- Cross-triggering unit coordinates ADC, timer, and PWM generation and minimizes CPU interrupt load
- Three eTimers
- Two ADCs
- This product is included in Freescale's product longevity program, with assured supply for a minimum of 15 years after launch

7 Required Equipment

KITMPC5643DBEVM is an extensible board for the KIT33908MBEVBE and cannot operate separately. Equipment list is considered for operation with the KIT33908MBEVBE uniquely. We can distinguish two modes of operation with this platform.

Recommended equipment for software development:

- Power supply 12 V/3.0 A
- USB A-B cable
- P&E USB Multi-link Debugger
- USB-enabled PC

Recommended equipment for hardware development (validation of Analog functionality etc.):

- Power supply: typically 12 V/3.0 A
- USB A-B cable
- USB-enabled PC

Recommended Software:

- Windows 7 32-bit operating system
- MC33907_8 Graphical User Interface
(http://www.freescale.com/webapp/sps/site/prod_summary.jsp?code=KIT33907AEEVB&fsp=1&tab=Design_Tools_Tab)
- CodeWarrior IDE for Qorivva MCU family installed
(http://www.freescale.com/webapp/sps/site/prod_summary.jsp?code=CW-MPC55XX_56XX&fsrch=1)

8 Evaluation Board Configuration

8.1 Evaluation Board Configuration for Software Development

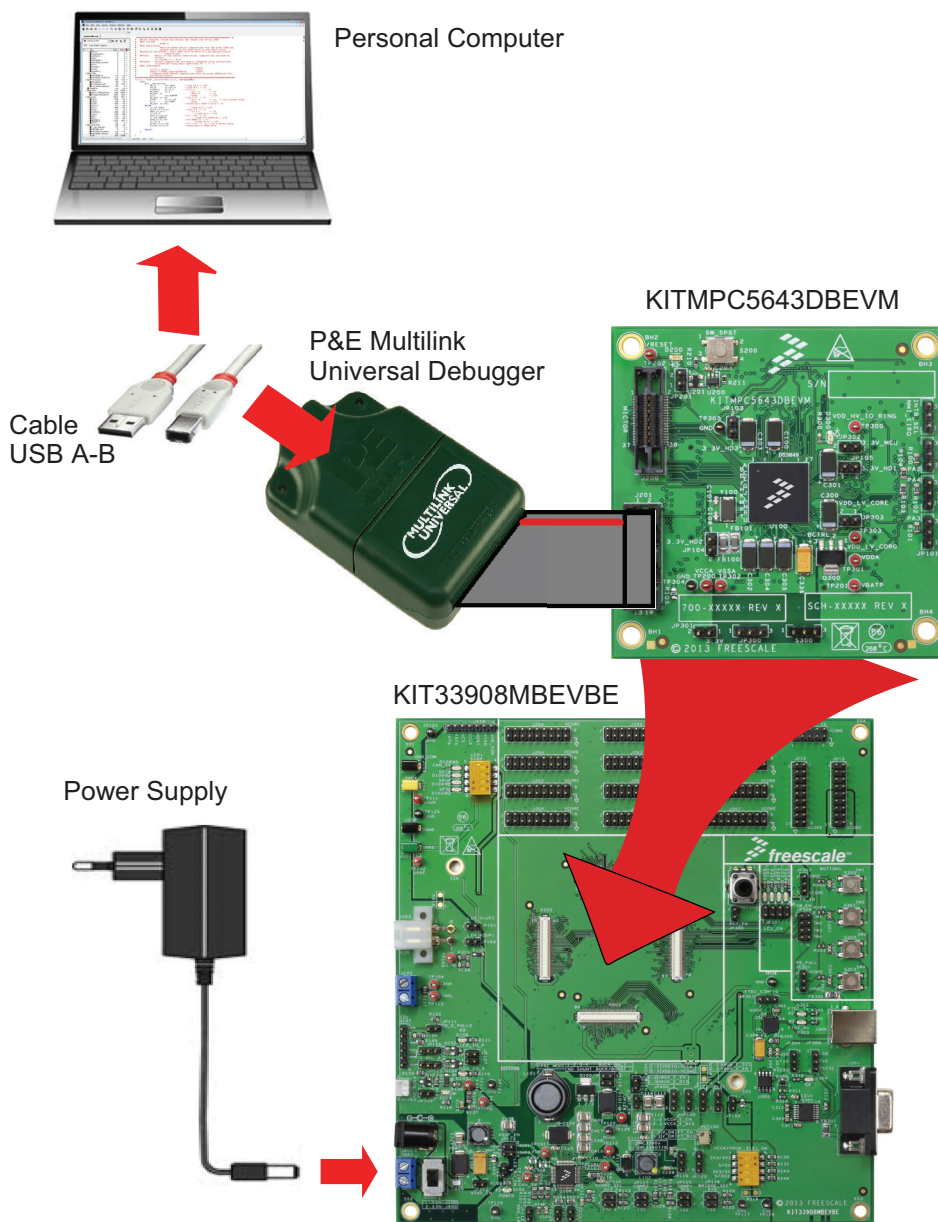

Figure 3. Recommended Configuration for Software Development

8.2 Evaluation Board Configuration for Hardware Development

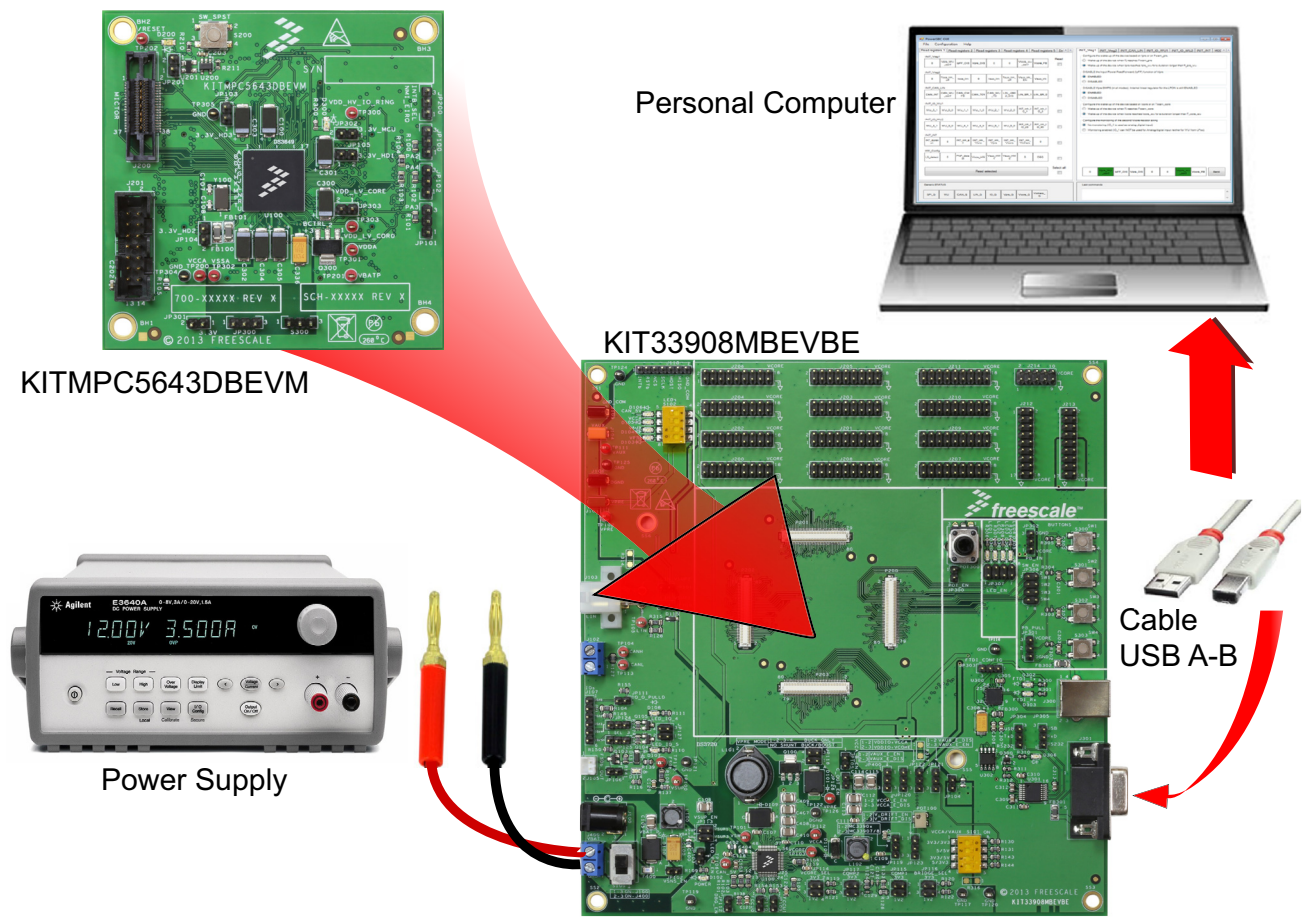

Figure 4. Recommended Configuration for Hardware Development

9 Setting Up and Using the Hardware

In order to perform the demonstration examples, first set up the evaluation board hardware and software as follows:

1. Install the MC33907_8 graphical user interface.
2. Plug the daughter board (KITMPC5643DBEVM) on the mother board platform (KIT33908MBEVBE).
3. Connect the power supply to the mother board and switch it on (verify the polarity of the power supply).
4. Connect the mother board to the PC using USB A-B cable.
5. Wait for the driver installation to complete (after the first connection, drivers for the device have to be installed). This takes several minutes.
6. When the installation is complete, a status message is displayed.
7. Launch the MC33907_8 graphical user interface.
8. Click the EVM button on the welcome screen to choose the enhanced evaluation board option.
9. Click on the tab called "Read registers 5". If the board works properly, the bits of the WD_LFSR register move randomly.

10 Evaluation Board Hardware Description

The evaluation board comes with a Freescale MPC5643L microcontroller mounted on it. Below is a board-level logic diagram.

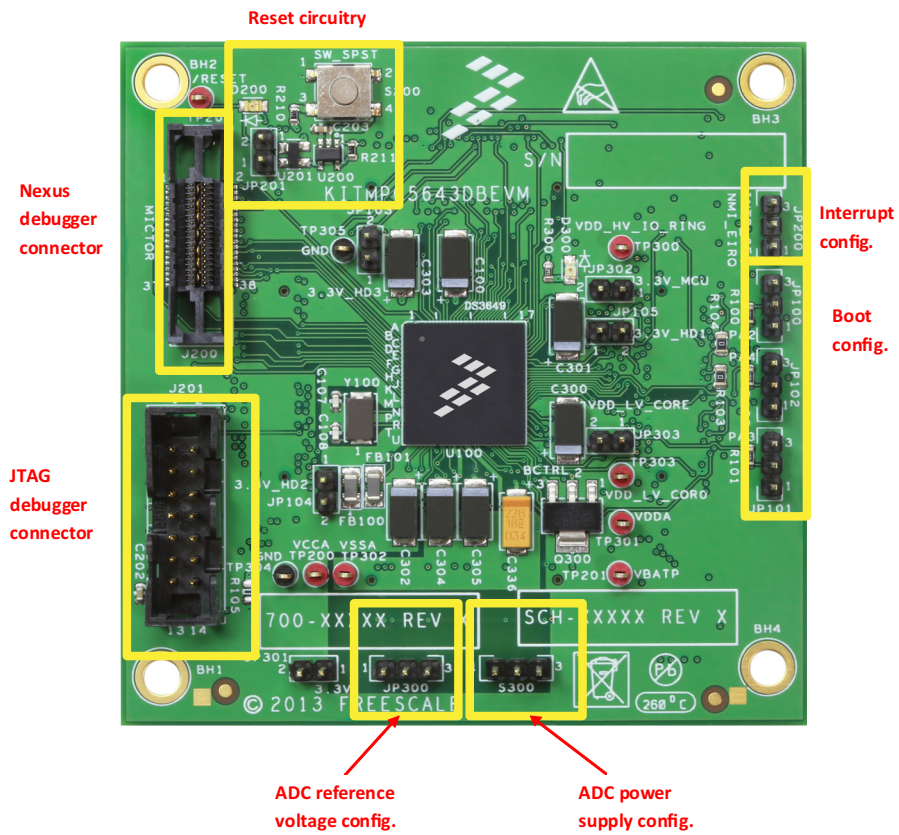

Figure 5. KITMPC5643DBEVM Block Diagram

10.1 LED Definitions

The following LEDs are provided as visual output devices for the KITMPC5643DBEVM evaluation board:

Table 1. LEDs

Schematic Label	Signal/Rail	Description
D200	LED_R	Reset indicator
D300	LED_Power	Power indicator

10.2 Test Point Definitions

The following test-point jumpers provide access to signals:

Table 2. Test Points

Schematic Label	Signal/Rail	Description
TP200	V _{CCA}	ADC power supply
TP201	V _{BAT_P}	Battery voltage (after protection diode)
TP202	Reset_MCU	Reset of the MCU
TP300	3.3 V	V _{CORE} voltage
TP301	VDDA	Power supply for ADC (filtered)
TP302	VSSA	Analog ground (connected to Vss of the ADC)
TP303	VDD_LV	Low-voltage core power supply (provided by external transistor that is controlled by internal regulator)
TP304	GND	ground
TP305	GND	ground

10.3 Connector Definitions

Table 3. Connectors

Connector	Description
J200	Nexus debugger interface
J201	JTAG debugger interface
P200	Interface to the mother board
P201	Interface to the mother board
P202	Interface to the mother board
P203	Interface to the mother board

10.4 Jumper and Switch Definitions

The following table defines the evaluation board jumper positions and explains their functions. For each jumper a default setting is shown on the left side.

Table 4. Jumpers and Switches

Schematic Label	Setting	Description
JP100	ABS0 – selection bit position 0 for Alternate Boot Selector See Table 5 for truth table.	
	1-2	ABS0 connected to GND
	2-3	ABS0 connected to V _{CORE} (activated)
JP101	ABS2 – selection bit position1 for Alternate Boot Selector See Table 5 for truth table.	
	1-2	ABS2 connected to GND
	2-3	ABS2 connected to V _{CORE} (activated)
JP102	FAB – Force Alternate Boot Mode See Table 5 for truth table.	
	1-2	Alternate Boot Mode disabled (connected to GND)
	2-3	Alternate Boot Mode enabled (connected to V _{CORE})

Table 4. Jumpers and Switches (continued)



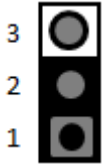
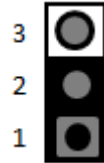
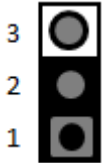

Schematic Label	Setting	Description
JP103 		VDD_HV_REG – enables Power Supply for internal voltage regulator block
JP104 		VDD_HV_OSC – enables Power Supply for oscillator block
JP105 		VDD_HV_FLASH – enables Power Supply for FLASH memory block
JP200 	1-2 2-3	INTb_SEL – selection of the MCU interrupt pin INTb pin from MC3390x is connected to the NMI (Non Maskable Interrupt) pin of the MCU INTb pin from the MC3390x is connected to a standard EIRQ interrupt pin of the MCU
JP201 		RST_EN – connects RESET of the MCU to the RESET circuitry

Table 4. Jumpers and Switches (continued)



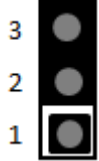

Schematic Label	Setting	Description
JP300	REF_ADC - reference voltage for ADC	
	1-2	V_{CCA} is used as a reference voltage
	2-3	V_{CORE} is used as a reference voltage
JP301	V_DBG_EN – connects V_{CORE} to the Debug connectors (JTAG, Nexus)	
		
JP302	VDD_HV_IO_RING – connects Power Supply (V_{CORE}) to the IO_RING	
		
JP303	VDD_LV_CORE – connects Power Supply to LV_CORE	
		
S200	RESET – manual Reset button	
S300	V_ADC_SEL – Power Supply for ADC block	
	1-2	V_{CCA} is used as a power supply
	2-3	V_{CORE} is used as a power supply

Table 5. Boot Mode Truth Table

FAB	ABS[2,0]	Boot Mode
1	00	LINFlex without autobaud
1	01	FlexCAN without autobaud
1	10	Scan of both interfaces (FlexCAN and LINFlex) with autobaud

10.4.1 Reset circuit

In the safety applications, RESET pin of the MCU is controlled directly by the MC33907 (or MC33908). For debugging purposes, the debugger has to have a full control over the RESET pin. Due to this fact, the Debugger is connected to RESET directly and the reset coming from MC33907 (or MC33908) is disabled by the jumper JP201. For debug purposes, a Reset button (S200) was added. As shown in [Figure 7](#), reset signals from MC33907 (or MC33908) and from manually controlled buttons are merged through an AND gate. This means that the MCU goes into reset if any of the reset signals are activated.

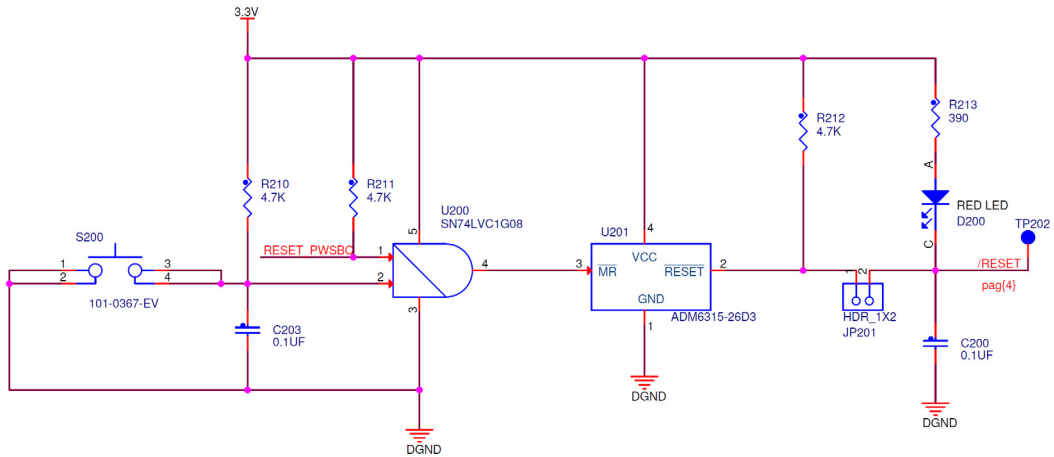

Figure 6. Reset Circuit

11 Interfacing with the Mother Board

11.1 Power Supplies

Power supply (power management) for the daughter board is completely provided by the mother board. Consequently, the mother board must be configured in a compatible way.

Caution: Incorrect configuration of the mother board can damage the MCU.

It is important to have a correct configuration of all power supplies. Recommended setting for the KITMPC5643DBEVM daughter board is shown in [Table 6](#) and [Figure 7](#).

Table 6. Power Supply Settings (Default Values in Grey)

Power supply name		Schematic Label	Jumper/ Switch Name	Jumper/ Switch Setting
V _{CORE} = 3.3 V		JP104	Vcore_EN	connected
		JP114	Vcore_SEL	1-2
		JP122	Vddio_SEL	2-3
V _{CCA} = 3.3 V	V _{AUX} = 5.0 V	S101	V _{CCA} /V _{AUX}	3-6
		S300	V_ADC_SEL	1-2
		JP300	REF_ADC	1-2
	V _{AUX} = 3.3 V	S101	V _{CCA} /V _{AUX}	1-8
		S300	V_ADC_SEL	1-2
		JP300	REF_ADC	1-2
V _{CCA} = 5.0 V	V _{AUX} = 5.0 V	S101	V _{CCA} /V _{AUX}	2-7
		S300	V_ADC_SEL	2-3
		JP300	REF_ADC	1-2
	V _{AUX} = 3.3 V	S101	V _{CCA} /V _{AUX}	4-5
		S300	V_ADC_SEL	2-3
		JP300	REF_ADC	1-2

Mother board - power management

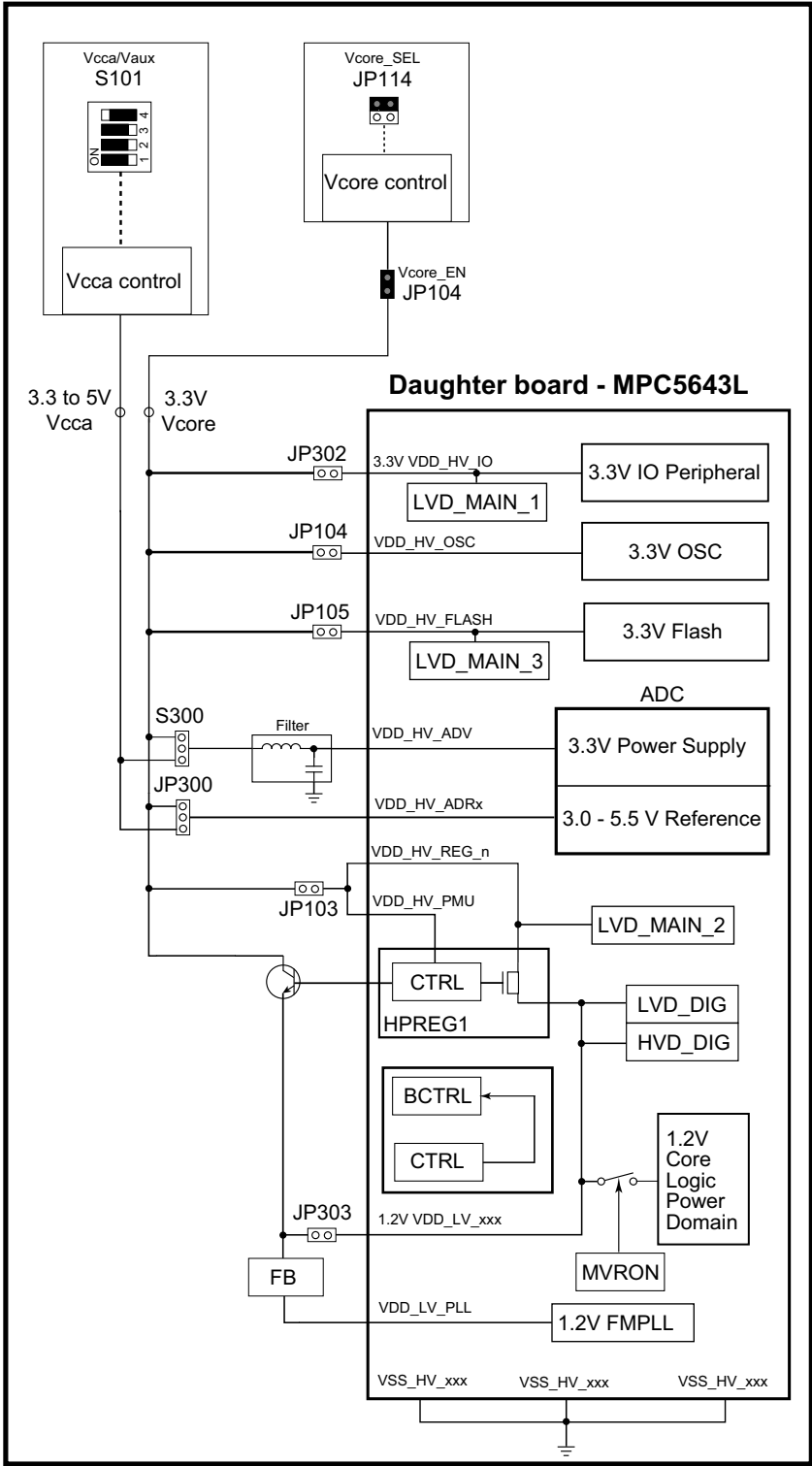

Figure 7. Power Supplies – Configuration of the Mother Board

11.2 Peripherals

Port mapping between peripherals on the mother and daughter boards is shown in [Table 7](#).

Table 7. Port Mapping Between Mother Board and the KITMPC5643DBEVM Daughter Board

Module/Pin	Pin function	MCU port	Jumper setting		MCU	
			Mother board	Daughter board	Pin	Module name
SPI	MOSI	PORTC			C[6]	DSPI_0
	MISO				C[7]	
	CLK				C[5]	
	NCS				C[4]	
ADC	Mux_OUT	PORTB	JP300		B[7]/AN[0]	ADC_0
	POT	PORTC			C[0]/AN[3]	ADC_1
UART	Tx	PORTD	JP304		D[9]	LINFlexD_1
	Rx		JP305		D[12]	
INTb	EIRQ	PORTA		JP200	A[0]/EIRQ[0]	
	NMI				/NMI	
RSTb				JP201	/RESET	
FCCU	FCCU[0]		JP110		FCCU_F[0]	FCCU
	FCCU[1]		JP109		FCCU_F[1]	
SIUL	SW1	PORTD	JP306		D[0]	SIUL
	SW2				D[1]	
	SW3				D[2]	
	SW4				D[3]	
	LED1		JP307		D[4]	
	LED2				D[5]	
	LED3				D[6]	
	LED4				D[7]	
CAN	Tx	PORTB			B[0]	FlexCAN[0]
	Rx				B[1]	
LIN	Tx	PORTB			B[2]	LINFlexD_0
	Rx				B[3]	

12 Schematic

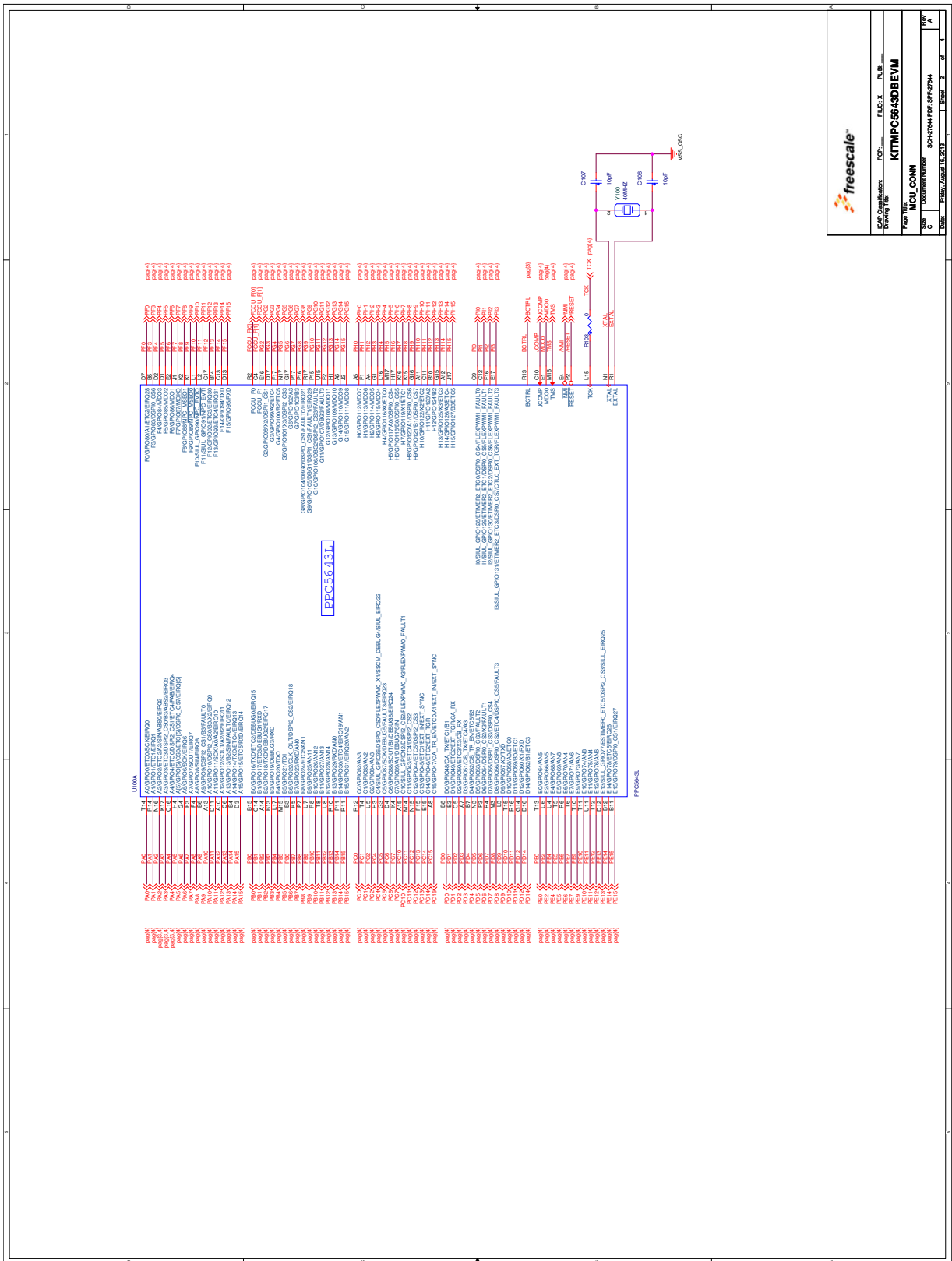

Figure 8. Evaluation Board Schematic, Part 1

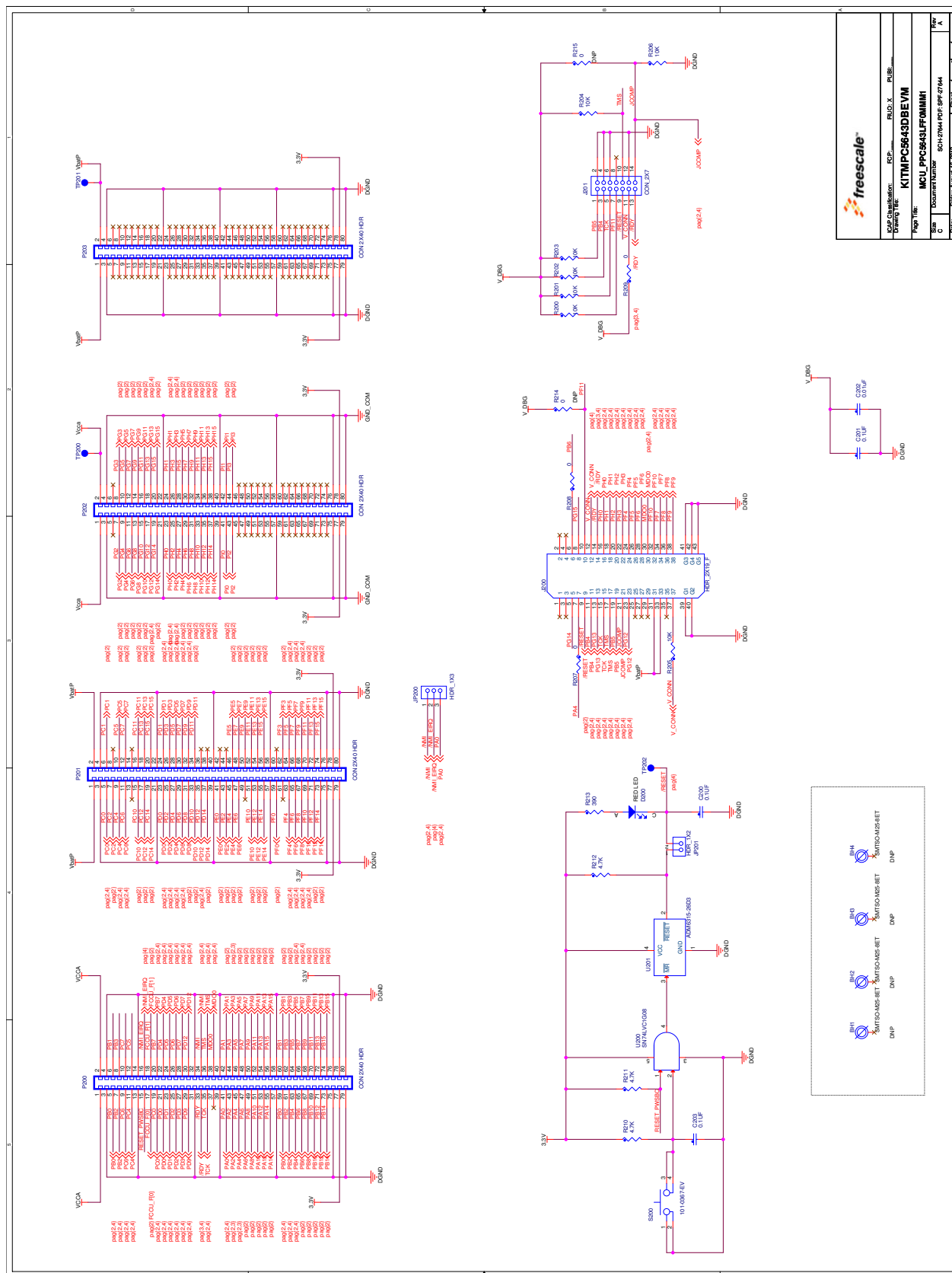
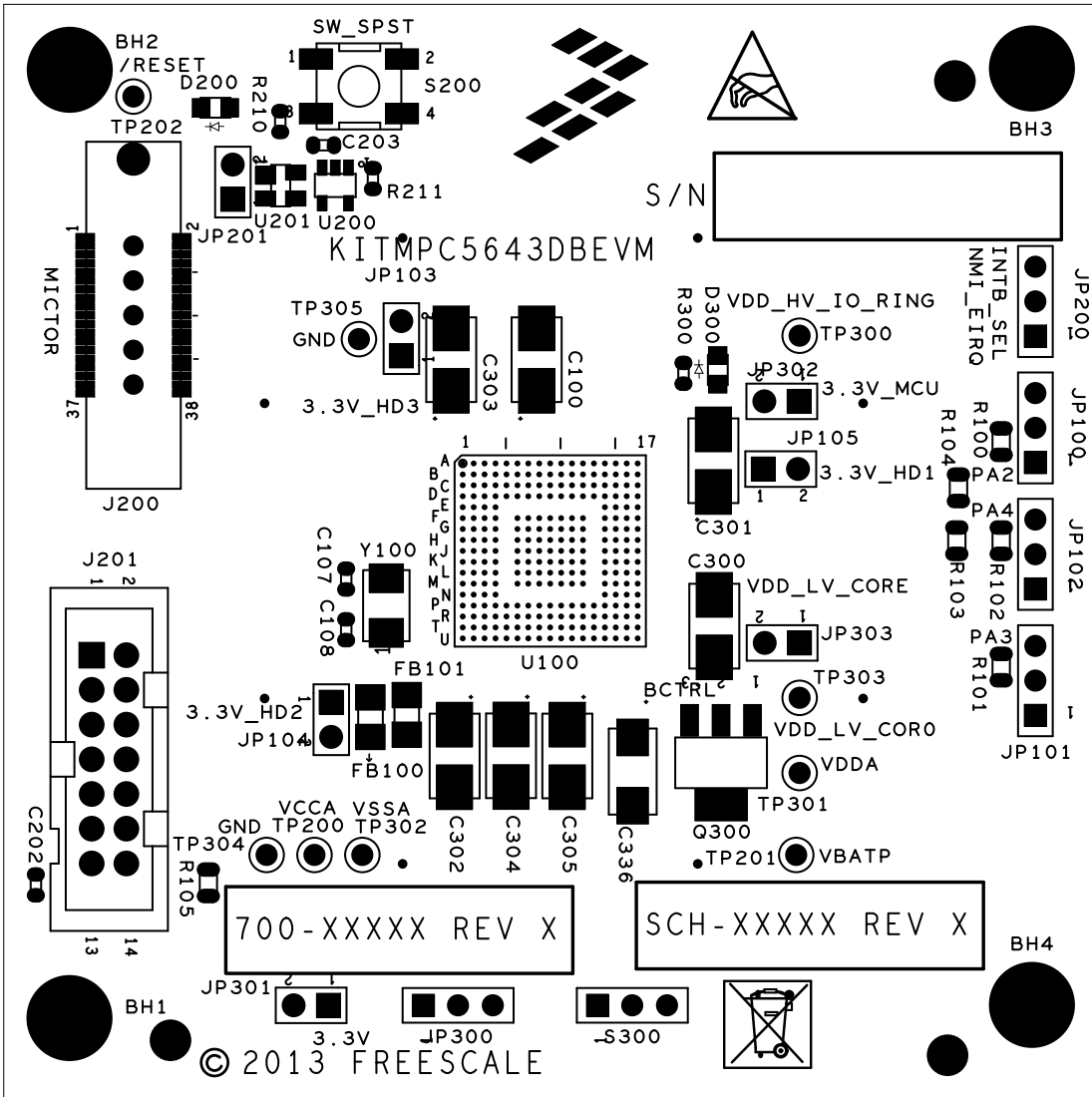

Figure 10. Evaluation Board Schematic, Part 3

13 Board Layout

13.1 Silk Screen Top



13.2 Silk Screen Bottom

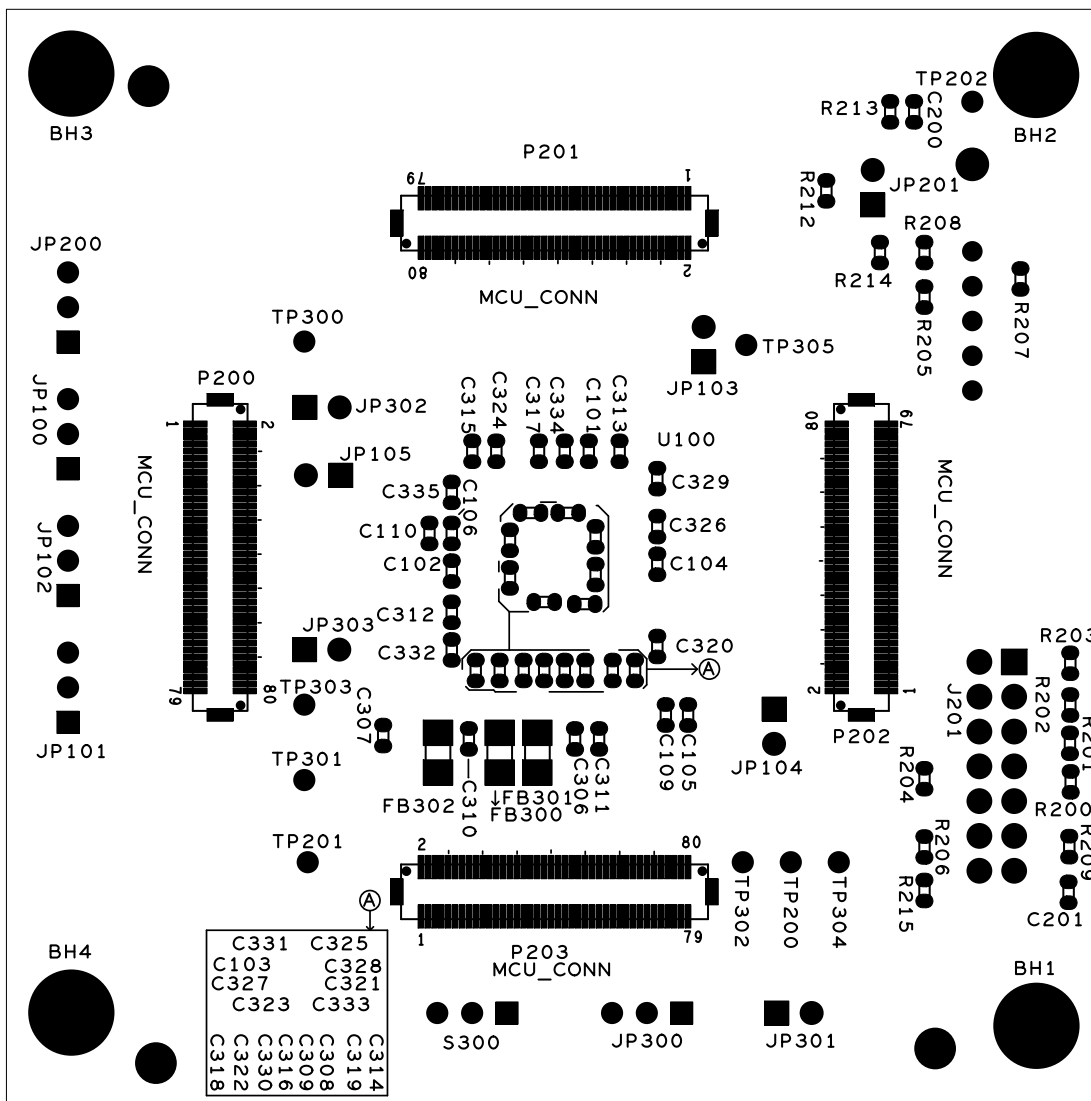

13.3 Top Layer Routing

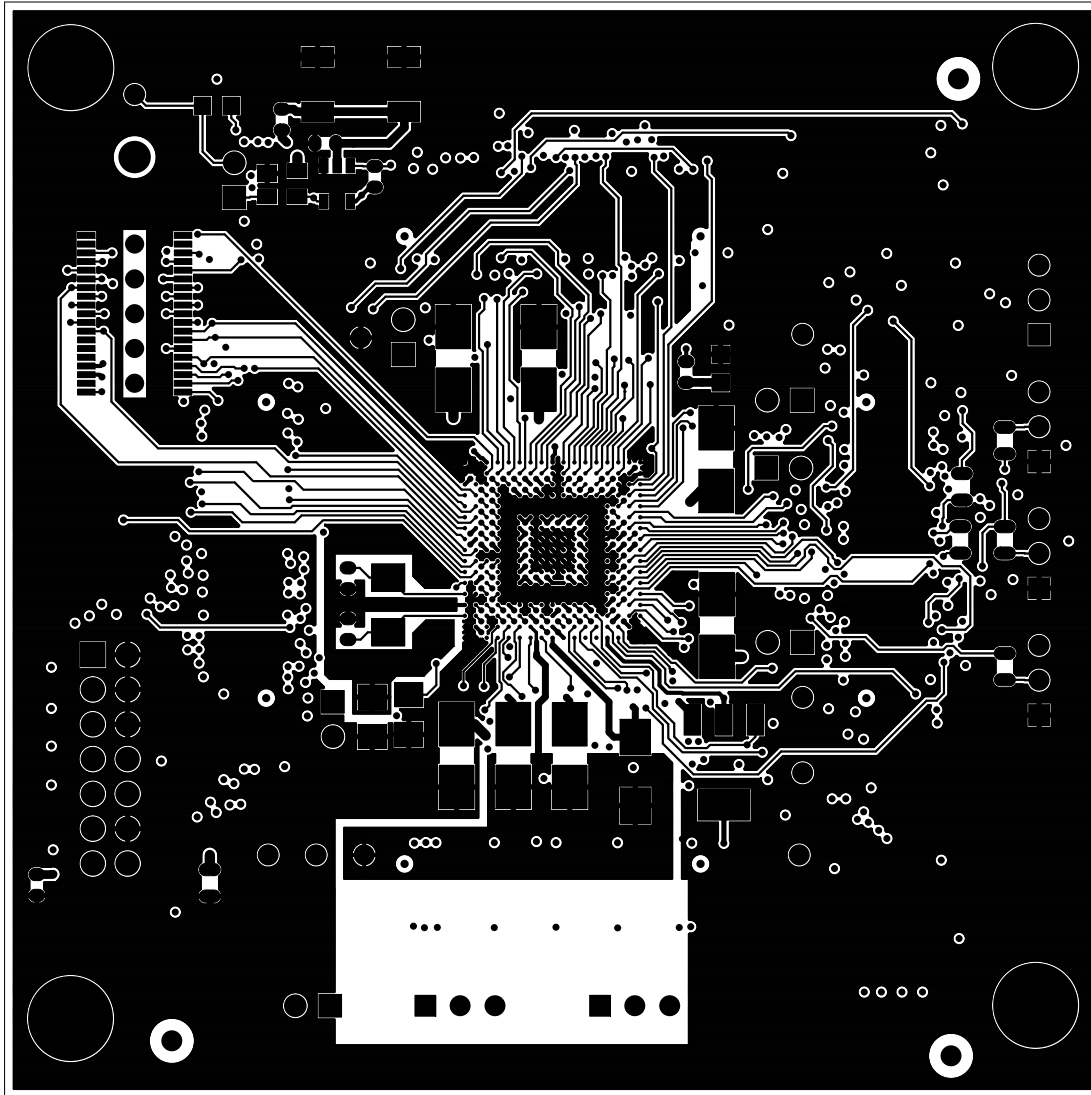

13.4 Inner Layer 1 Routing

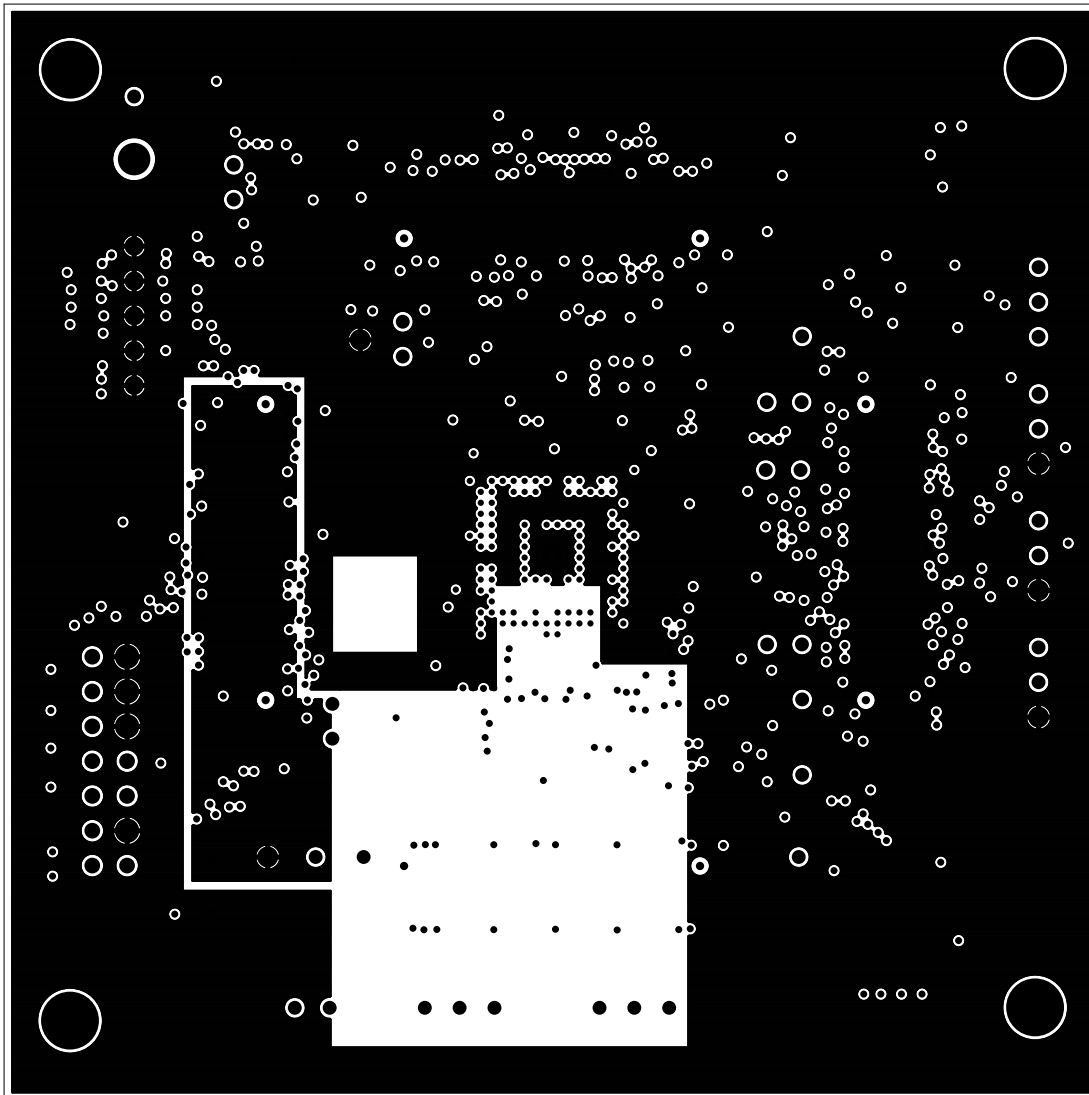

13.5 Inner Layer 2 Routing

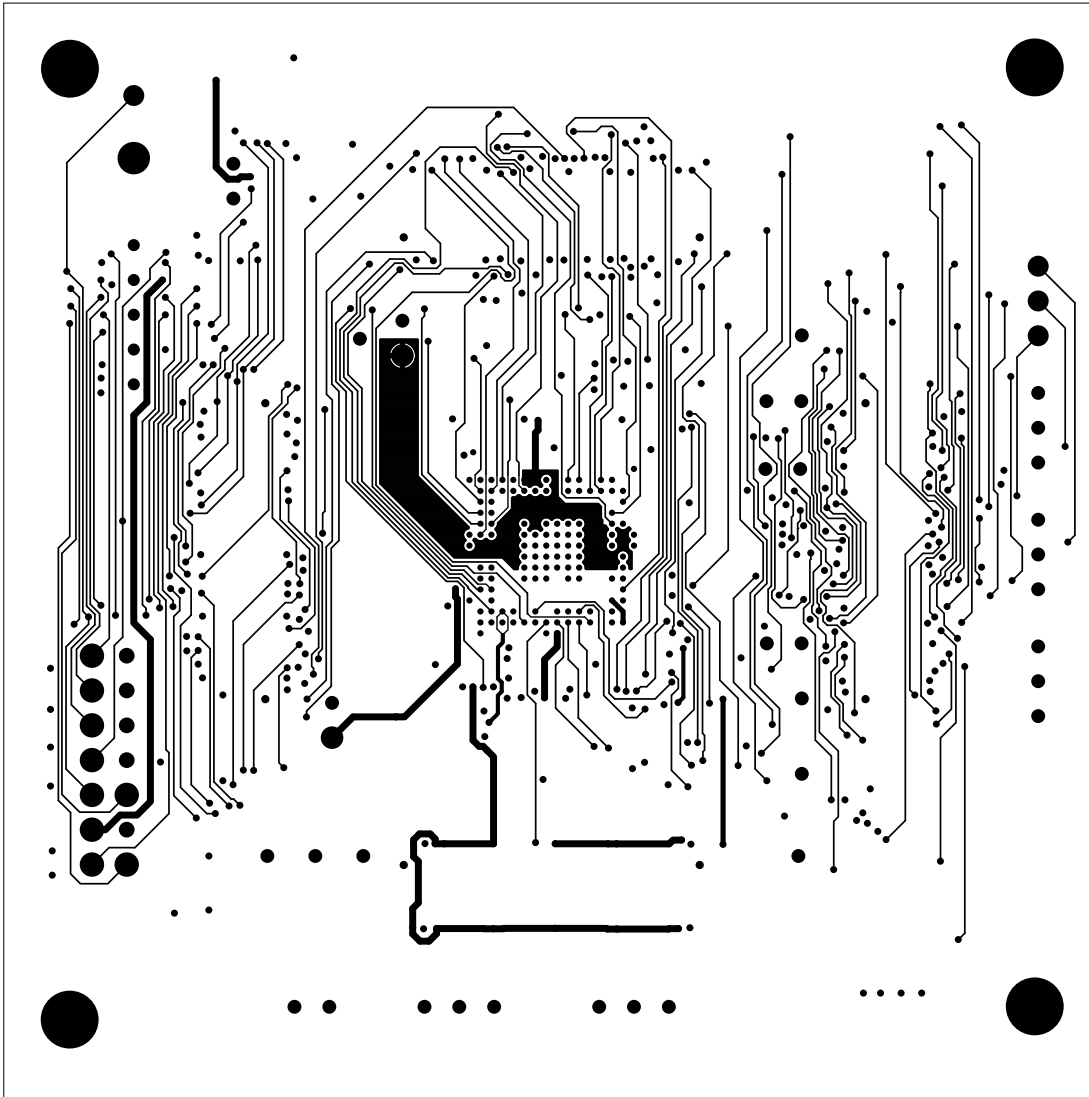

13.6 Inner Layer 3 Routing

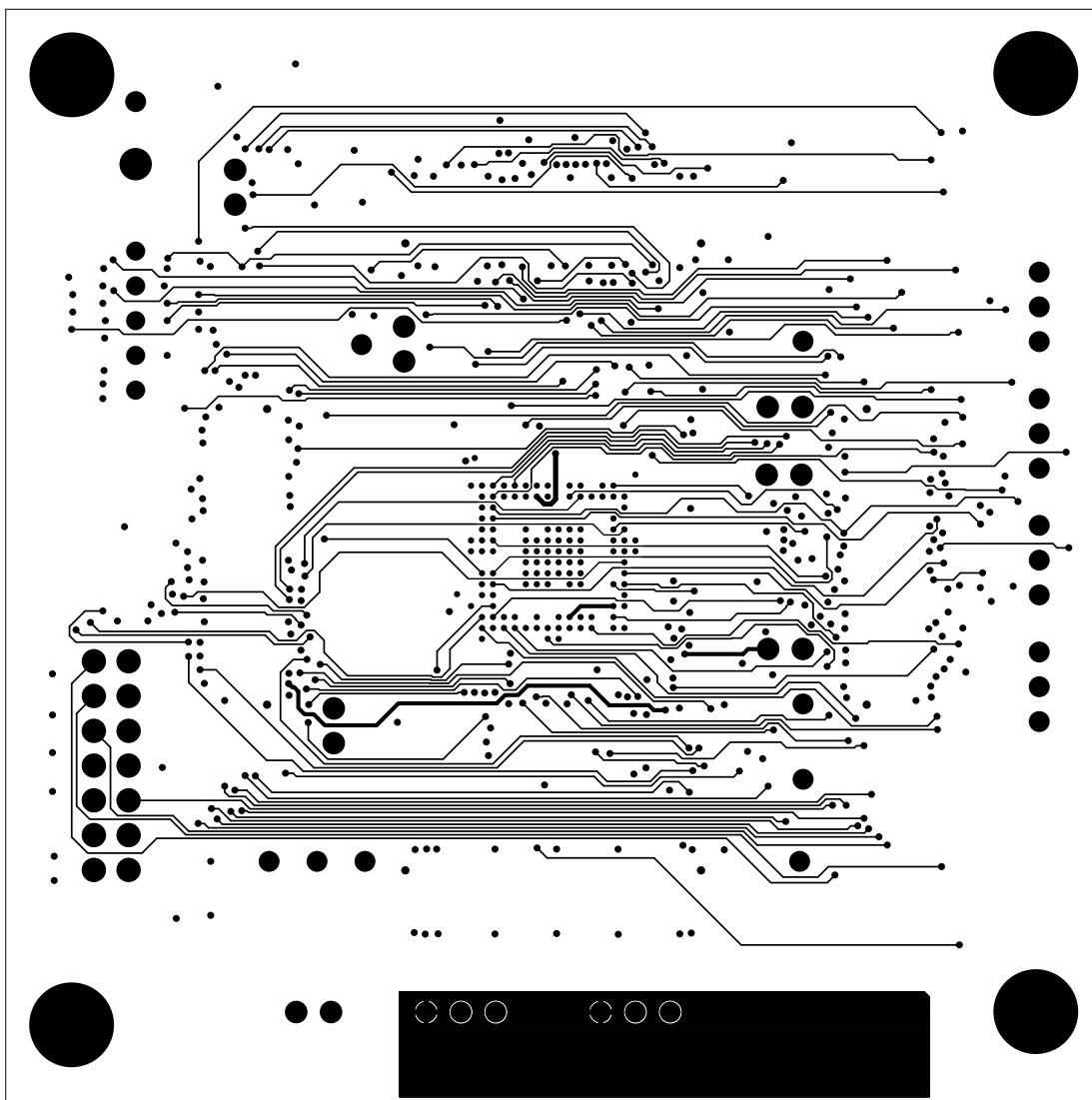

13.7 Inner Layer 4 Routing

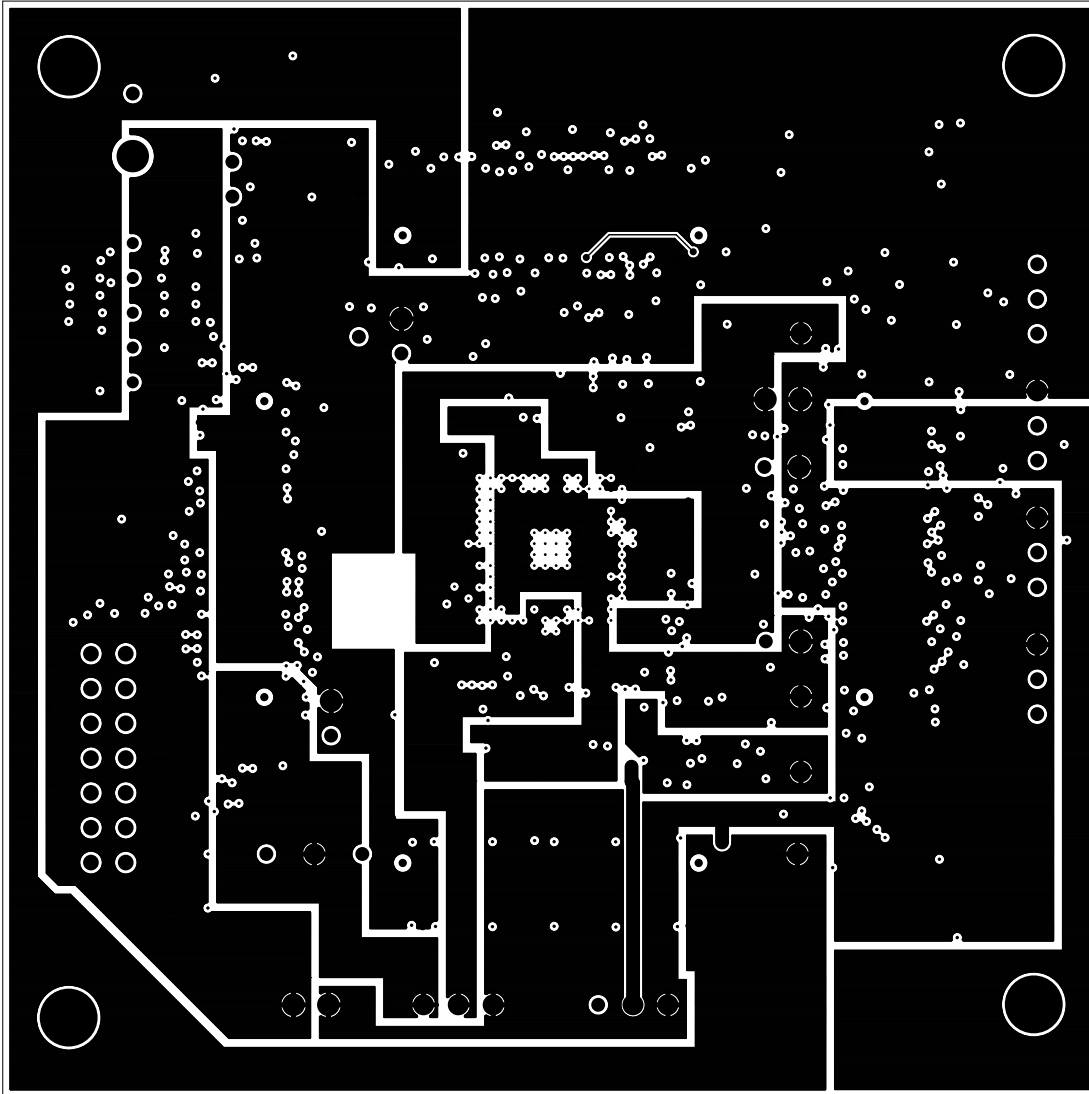

13.8 Bottom Layer Routing

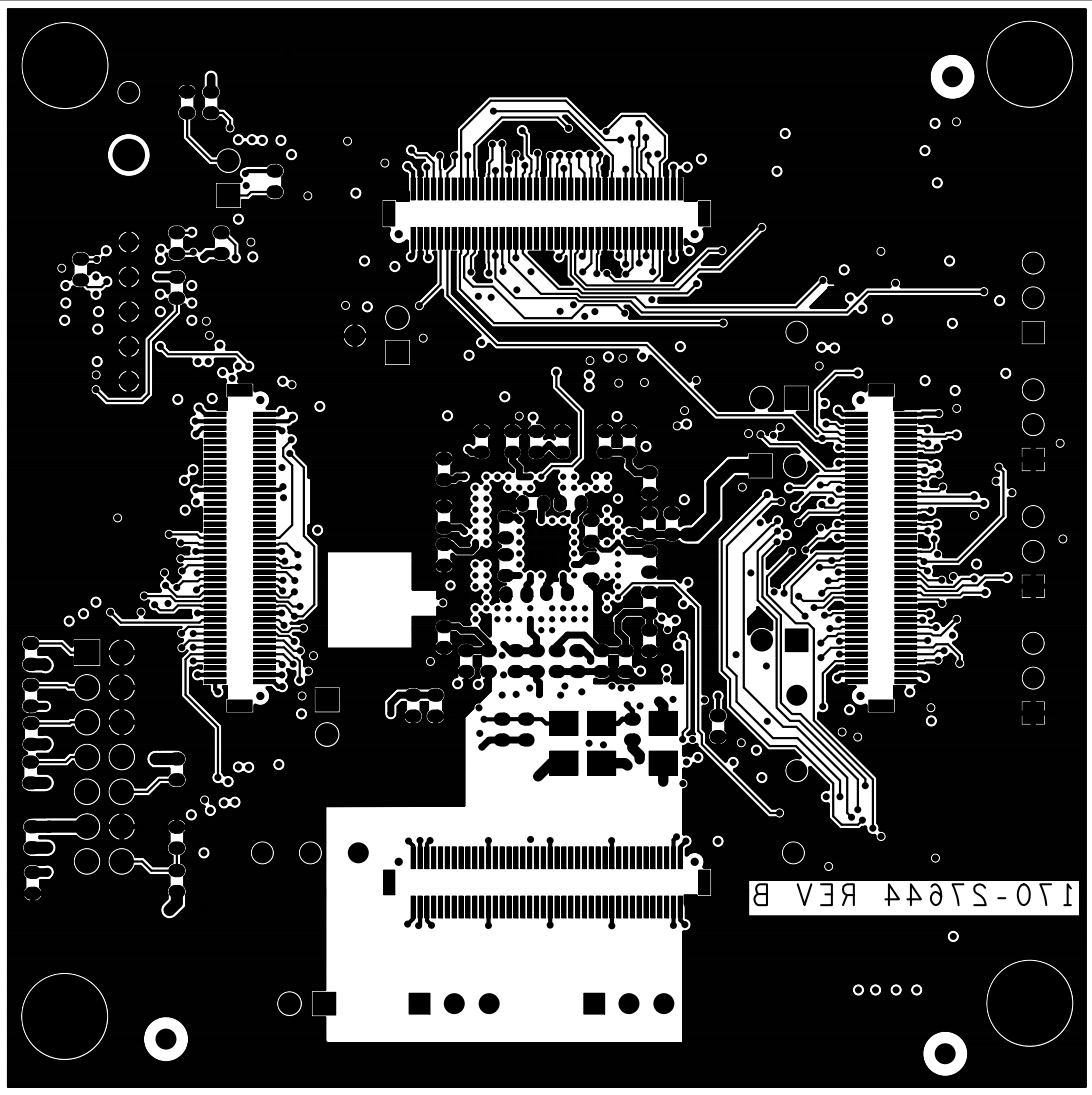

14 Bill of Materials

Table 8. Bill of Materials ⁽¹⁾

Item	Qty	Schematic Label	Value	Manufacturer	Part Number	Assy Opt
1	4	BH1, BH2, BH3, BH4		PEM FASTENERS	SMTSO-M25-8ET	(2)
2	7	C100, C300, C301, C302, C303, C304, C305	10 μ F	AVX	TAJC106K016RNJ	
3	11	C101, C102, C103, C104, C105, C106, C200, C201, C203, C306, C307	0.1 μ F	MURATA	GRM188R71H104KA93D	
4	2	C107, C108	10 pF	AVX	06035C100KAT2A	
5	7	C109, C110, C202, C308, C309, C310, C311	0.01 μ F	YAGEO AMERICA	CC0603KRX7R8BB103	
6	8	C312, C313, C314, C315, C316, C317, C318, C319	470 pF	AVX	06035C471KAT2A	
7	8	C320, C322, C324, C326, C329, C332, C334, C335	0.22 μ F	TDK	C1608X7R1C224KT	
8	8	C321, C323, C325, C327, C328, C330, C331, C333	0.22 μ F	KEMET	C0603C224K3RACTU	
9	1	C336	22 μ F	VISHAY INTERTECHNOLOGY	293D226X9016C2TE3	
10	1	D200		LUMEX	RED LED SML-LXT0805IW-TR	
11	1	D300		LUMEX	SML-LXT0805GW-TR	
12	5	FB100, FB101, FB300, FB301, FB302	26 Ohm	LAIRD TECHNOLOGIES	MI1206K260R-10	
13	6	JP100, JP101, JP102, JP200, S300, JP300		SAMTEC	HDR_1X3 TSW-103-14-G-S	
14	7	JP103, JP104, JP105, JP201, JP301, JP302, JP303		3M	HDR_1X2 961102-6404-AR	
15	1	J200		TYCO ELECTRONICS	HDR_2X19_F 2-5767004-2	
16	1	J201		3M	CON_2X7 N2514-6002RB	
17	4	P200, P201, P202, P203		HIROSE	CON 2X40 HDR DF12 (3.0)-80DP-0.5V (86)	
18	1	Q300		ON SEMICONDUCTOR	BCP68T1G	(3)
19	3	R100, R101, R102	10 K	SMEC	RC73L2A103JTF	
20	2	R103, R104	0	YAGEO AMERICA	RC0805JR-070RL	
21	1	R105	0	YAGEO AMERICA	RC0805JR-070RL	(2)
22	7	R200, R201, R202, R203, R204, R205, R206	10 K	KOA SPEER	RK73B1JTDD103J	
23	3	R207, R208, R209	0	VISHAY INTERTECHNOLOGY	CRCW06030000Z0EA	
24	3	R210, R211, R212	4.7 K	VISHAY INTERTECHNOLOGY	CRCW06034K70JNEA	
25	2	R213, R300	390	KOA SPEER	RK73B1JTDD391J	
26	2	R214, R215	0	VISHAY INTERTECHNOLOGY	CRCW06030000Z0EA	(2)

Table 8. Bill of Materials ⁽¹⁾ (continued)

Item	Qty	Schematic Label	Value	Manufacturer	Part Number	Assy Opt
27	1	S200		MOUNTAIN	101-0367-EV	
28	7	TP200, TP201, TP202, TP300, TP301, TP302, TP303		KEYSTONE ELECTRONICS	TEST POINT RED 5000	
29	2	TP304, TP305		COMPONENTS CORPORATION	TEST POINT BLACK TP-105-01-00	
30	1	U100		FREESCALE SEMICONDUCTOR	PPC5643LFF2MMM1	
31	1	U200		TEXAS INSTRUMENTS	SN74LVC1G08DBVRE4	
32	1	U201		Analog Devices	ADM6315-26D3ARTZ	
33	1	Y100		NDK	40 MHz NX5032GA-40.000M-AT-W	

Notes

1. Freescale does not assume liability, endorse, or warrant components from external manufacturers that are referenced in circuit drawings or tables. While Freescale offers component recommendations in this configuration, it is the customer's responsibility to validate their application.
2. Do not Populate
3. Critical Components. For critical components, it is vital to use the manufacturer listed.

15 References

Following are URLs where you can obtain information on related Freescale products and application solutions:

Freescale.com Support Pages	URL
MC33908 Product Summary Page	http://www.freescale.com/webapp/sps/site/prod_summary.jsp?code=MC33908
KIT33908MBEVBE Tool Summary Page	http://www.freescale.com/webapp/sps/site/prod_summary.jsp?code=KIT33908MBEVBE
MPC564xL Product Summary Page	http://www.freescale.com/webapp/sps/site/prod_summary.jsp?code=MPC564xL
KITMPC5643DBEVM Tool Summary Page	http://www.freescale.com/webapp/sps/site/prod_summary.jsp?code=KITMPC5643DBEVM
KIT908-5643EVM Tool Summary Page	http://cache.freescale.com/files/analog/doc/prod_summary.jsp?code=KIT908-5643EVM
Analog Home Page	http://www.freescale.com/analog
Automotive Home Page	http://www.freescale.com/automotive

15.1 Support

Visit www.freescale.com/support for a list of phone numbers within your region.

15.2 Warranty

Visit www.freescale.com/warranty for a list of phone numbers within your region.

16 Revision History

Revision	Date	Description of Changes
1.0	3/2014	<ul style="list-style-type: none"> • Initial Release



How to Reach Us:

Home Page:
freescale.com

Web Support:
freescale.com/support

Information in this document is provided solely to enable system and software implementers to use Freescale products. There are no express or implied copyright licenses granted hereunder to design or fabricate any integrated circuits based on the information in this document.

Freescale reserves the right to make changes without further notice to any products herein. Freescale makes no warranty, representation, or guarantee regarding the suitability of its products for any particular purpose, nor does Freescale assume any liability arising out of the application or use of any product or circuit, and specifically disclaims any and all liability, including without limitation consequential or incidental damages. "Typical" parameters that may be provided in Freescale data sheets and/or specifications can and do vary in different applications, and actual performance may vary over time. All operating parameters, including "typicals," must be validated for each customer application by customer's technical experts. Freescale does not convey any license under its patent rights nor the rights of others. Freescale sells products pursuant to standard terms and conditions of sale, which can be found at the following address: freescale.com/SalesTermsandConditions.

Freescale, the Freescale logo, and the Energy Efficient Solutions logo are trademarks of Freescale Semiconductor, Inc., Reg. U.S. Pat. & Tm. Off. SafeAssure and SMARTMOS are trademarks of Freescale Semiconductor, Inc. All other product or service names are the property of their respective owners.

© 2014 Freescale Semiconductor, Inc.

Document Number: KT MPC5643DBUG
Rev. 1.0
3/2014



X-ON Electronics

Largest Supplier of Electrical and Electronic Components

Click to view similar products for [Daughter Cards & OEM Boards](#) category:

Click to view products by [NXP](#) manufacturer:

Other Similar products are found below :

[ADZS-21262-1-EZEXT](#) [27911](#) [KITMPC5744DBEVM](#) [SPC56ELADPT144S](#) [TMDXRM46CNCD](#) [DM160216](#) [MPC5777M-416DS](#) [EV-ADUCM350GPIOTHZ](#) [EV-ADUCM350-BIO3Z](#) [ATSTK521](#) [1130](#) [MA160015](#) [MA180033](#) [MA240013](#) [MA240026](#) [MA320014](#) [MA330014](#) [MA330017](#) [TLK10034SMAEVM](#) [MIKROE-2152](#) [MIKROE-2154](#) [MIKROE-2381](#) [TSSOP20EV](#) [DEV-11723](#) [MIKROE-1108](#) [MIKROE-1516](#) [SPS-READER-GEVK](#) [AC244049](#) [AC244050](#) [AC320004-3](#) [2077](#) [ATSMARTCARD-XPRO](#) [EIC - Q600 -230](#) [ATZB-212B-XPRO](#) [SPC560PADPT100S](#) [SPC560BADPT64S](#) [MA180018](#) [EIC - Q600 -220](#) [AC164134-1](#) [BOB-12035](#) [BB-BONE-BATT-01](#) [STM8/128-D/RAIS](#) [AC164127-6](#) [AC164127-4](#) [AC164134-3](#) [AC164156](#) [MA320021](#) [MA320024](#) [DFR0285](#) [DFR0312](#)