

KITMPC5744DBEVM Evaluation Daughter Board

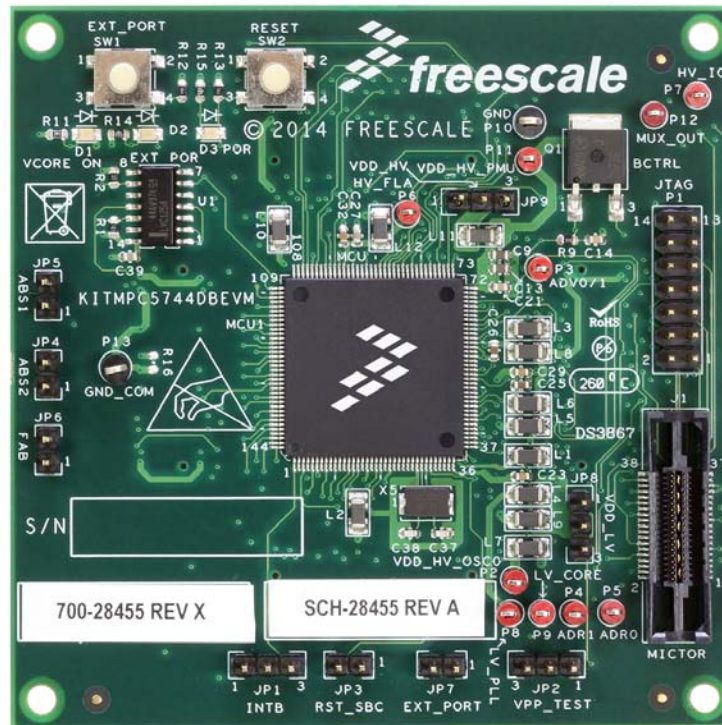

Figure 1. KITMPC5744DBEVM



Contents

1 Important Notice	3
2 Getting Started	4
3 Getting to Know the Hardware	5
4 Installing the Software and Setting up the Hardware	15
5 Schematic	18
6 Board Layout.	21
7 Bill of Materials	23
8 References	25
9 Revision History	26

1 Important Notice

Freescale provides the enclosed product(s) under the following conditions:

This evaluation kit is intended for use of ENGINEERING DEVELOPMENT OR EVALUATION PURPOSES ONLY. It is provided as a sample IC pre-soldered to a printed circuit board to make it easier to access inputs, outputs, and supply terminals. This evaluation kit may be used with any development system or other source of I/O signals by simply connecting it to the host MCU or computer board via off-the-shelf cables. Final device in an application will be heavily dependent on proper printed circuit board layout and heat sinking design as well as attention to supply filtering, transient suppression, and I/O signal quality.

The goods provided may not be complete in terms of required design, marketing, and or manufacturing related protective considerations, including product safety measures typically found in the end product incorporating the goods. Due to the open construction of the product, it is the user's responsibility to take any and all appropriate precautions with regard to electrostatic discharge. In order to minimize risks associated with the customers applications, adequate design and operating safeguards must be provided by the customer to minimize inherent or procedural hazards. For any safety concerns, contact Freescale sales and technical support services.

Should this evaluation kit not meet the specifications indicated in the kit, it may be returned within 30 days from the date of delivery and will be replaced by a new kit.

Freescale reserves the right to make changes without further notice to any products herein. Freescale makes no warranty, representation or guarantee regarding the suitability of its products for any particular purpose, nor does Freescale assume any liability arising out of the application or use of any product or circuit, and specifically disclaims any and all liability, including without limitation consequential or incidental damages. "Typical" parameters can and do vary in different applications and actual performance may vary over time. All operating parameters, including "Typical", must be validated for each customer application by customer's technical experts.

Freescale does not convey any license under its patent rights nor the rights of others. Freescale products are not designed, intended, or authorized for use as components in systems intended for surgical implant into the body, or other applications intended to support or sustain life, or for any other application in which the failure of the Freescale product could create a situation where personal injury or death may occur.

Should the Buyer purchase or use Freescale products for any such unintended or unauthorized application, the Buyer shall indemnify and hold Freescale and its officers, employees, subsidiaries, affiliates, and distributors harmless against all claims, costs, damages, and expenses, and reasonable attorney fees arising out of, directly or indirectly, any claim of personal injury or death associated with such unintended or unauthorized use, even if such claim alleges that Freescale was negligent regarding the design or manufacture of the part. Freescale™ and the Freescale logo are trademarks of Freescale Semiconductor, Inc. All other product or service names are the property of their respective owners. © Freescale Semiconductor, Inc. 2015

2 Getting Started

2.1 Kit Contents/Packing List

The KITMPC5744DBEVM contents include:

- Assembled and tested evaluation board/module in anti-static bag.
- The board preloaded with demo software
- Warranty card

2.2 Jump Start

Freescale's analog product development boards help to easily evaluate Freescale products. These tools support analog mixed signal and power solutions including monolithic ICs using proven high-volume SMARTMOS mixed signal technology, and system-in-package devices utilizing power, SMARTMOS and MCU dies. Freescale products enable longer battery life, smaller form factor, component count reduction, ease of design, lower system cost and improved performance in powering state of the art systems.

- Go to www.freescale.com/analogtools
- Locate your kit
- Review your Tool Summary Page
- Look for



- Download documents, software and other information

Once the files are downloaded, review the user guide in the bundle. The user guide includes setup instructions, BOM and schematics. Jump start bundles are available on each tool summary page with the most relevant and current information. The information includes everything needed for design.

2.3 Required Equipment and Software

KITMPC5744DBEVM is an extensible board for the KIT33908MBEVBE and cannot operate separately. Equipment list is considered for operation with the KIT33908MBEVBE uniquely. We can distinguish two modes of operation with this platform.

Recommended equipment for software development:

- Power supply 12 V/3.0 A
- USB A-B cable
- Debugger for the MPC5744P MCU
- USB-enabled PC

Recommended equipment for hardware development (validation of Analog functionality etc.):

- Power supply: typically 12 V/3.0 A
- USB A-B cable
- USB-enabled PC

Recommended software:

- MC33907_8 Graphical User Interface (GUI)
(http://www.freescale.com/webapp/sps/site/prod_summary.jsp?code=KIT33907AEEVB&fosp=1&tab=Design_Tools_Tab)
- Greenhills IDE for Qorivva MCU family installed (http://www.ghs.com/products/MULTI_IDE.html)

2.4 System Requirements

The kit requires the following to function properly with the software:

- x86 or compatible processor
- Windows 7, 32-bit, Service Pack 1
- .NET Framework 4.0 or higher

3 Getting to Know the Hardware

3.1 Board Overview

The KITMPC5744DBEVM evaluation board is populated with a MPC5744P safety oriented microcontroller from the Qorivva family. The KITMPC5744DBEVM is a daughter board that extends the KIT33908MBEVBE kit (populated with MC33908 System Basis chip). Together, these two kits create a platform that forms a base for a Safety Ecosystem, which can reach the highest level in functional safety as defined by the ISO26262. The whole platform is shown in Figure 2.

The daughter board includes the MCU and external components necessary for its basic operation as the decoupling capacitors, crystal oscillator, reset circuitry, LED indicators, etc. Power supply and intelligent power management including enhanced safety features is provided to the daughter board from the mother board. Due to this, the daughter board cannot operate separately and it has to be plugged on the mother board (using four 80-pin connectors).

The daughter board is delivered with a demo software already loaded in the Flash memory of the MPC5744P. This code provides algorithms and procedures necessary to initialize and operate the MC33908 correctly. See the KT MPC5744DBSWUG - Basic SW Drivers for MPC5744P.

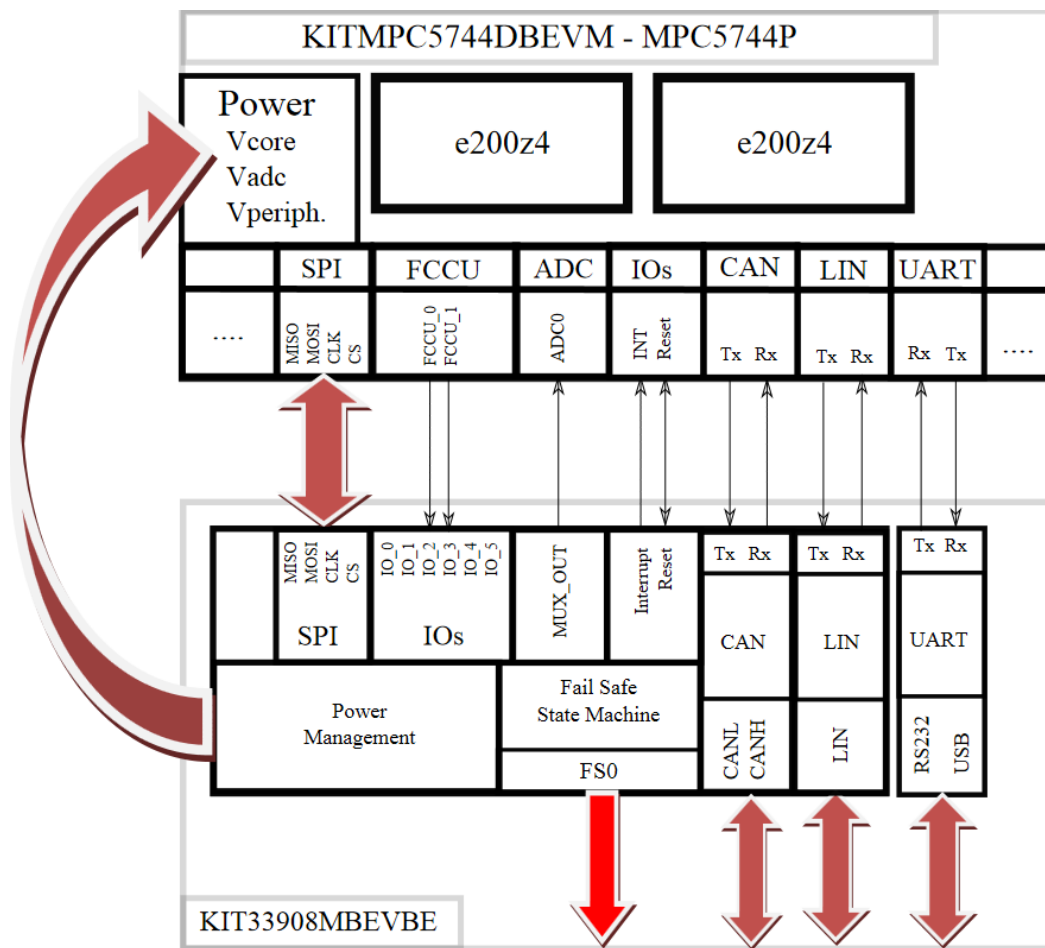

Figure 2. Interfacing with the KIT33908MBEVBE

3.2 Board Features

The board features are as follows:

- Qorivva MPC5744P 32-bit microcontroller with safety architecture
- Preloaded software demo for the MC33908 and MPC5744P platform
- Designed to be plugged onto the KIT33908MBEVBE Evaluation Board
- Separated power supplies for the core and the ADC
- High precision VCCA power supply connected to the ADC reference voltage
- Equipped by Nexus and JTAG for simple debug
- Possible to connect USB/RS232 through the mother board

3.3 Device Features

This evaluation board features the following Freescale products:

Table 1. Device Features

Device	Description	Features
MPC5744P	The MPC5744P is a Qorivva 32-bit embedded Power Architecture [®] MCU family designed for automotive and industrial functional safety applications.	<ul style="list-style-type: none"> • Dual e200 Z4 CPU architecture • Dual processing spheres including; CPU, DMA, interrupt controller, crossbar, and MPU for logic level fault detection • Two statically configurable modes of operation: Lockstep operation (redundant processing and calculations) and dual parallel mode (independent core operation) • Fault collection unit, which monitors and manages fault events • Error correction coding on RAM and flash memory allows detection/correction of memory errors • Safety oriented MCU to achieve ISO 26262 functional safety standard certification • Robust communications with FlexRay[™] and CAN/safety port high-speed low latency messaging • Cross-triggering unit coordinates ADC, timer, and PWM generation and minimizes CPU interrupt load • Peripheral modules (ADCs, eTimers, ...) • This product is included in Freescale's product longevity program, with assured supply for a minimum of 15 years after launch
MC33908	The MC33908 System Basis Chip (SBC), a Freescale Energy-Efficient solution, provides power to MCUs and other system loads and optimizes energy consumption.	<ul style="list-style-type: none"> • Flexible DC/DC pre-regulator allowing Buck or Buck-Boost • Optional Boost to improve system availability at cranking • Multiple output power supplies from 0.5 A up to 2.0 A • DC/DC voltage regulator to supply MCU core up to 1.5 A

3.4 Board Description

The evaluation board comes with a mounted Freescale MPC5744P microcontroller. The board-level logic diagram is featured in [Figure 3](#).

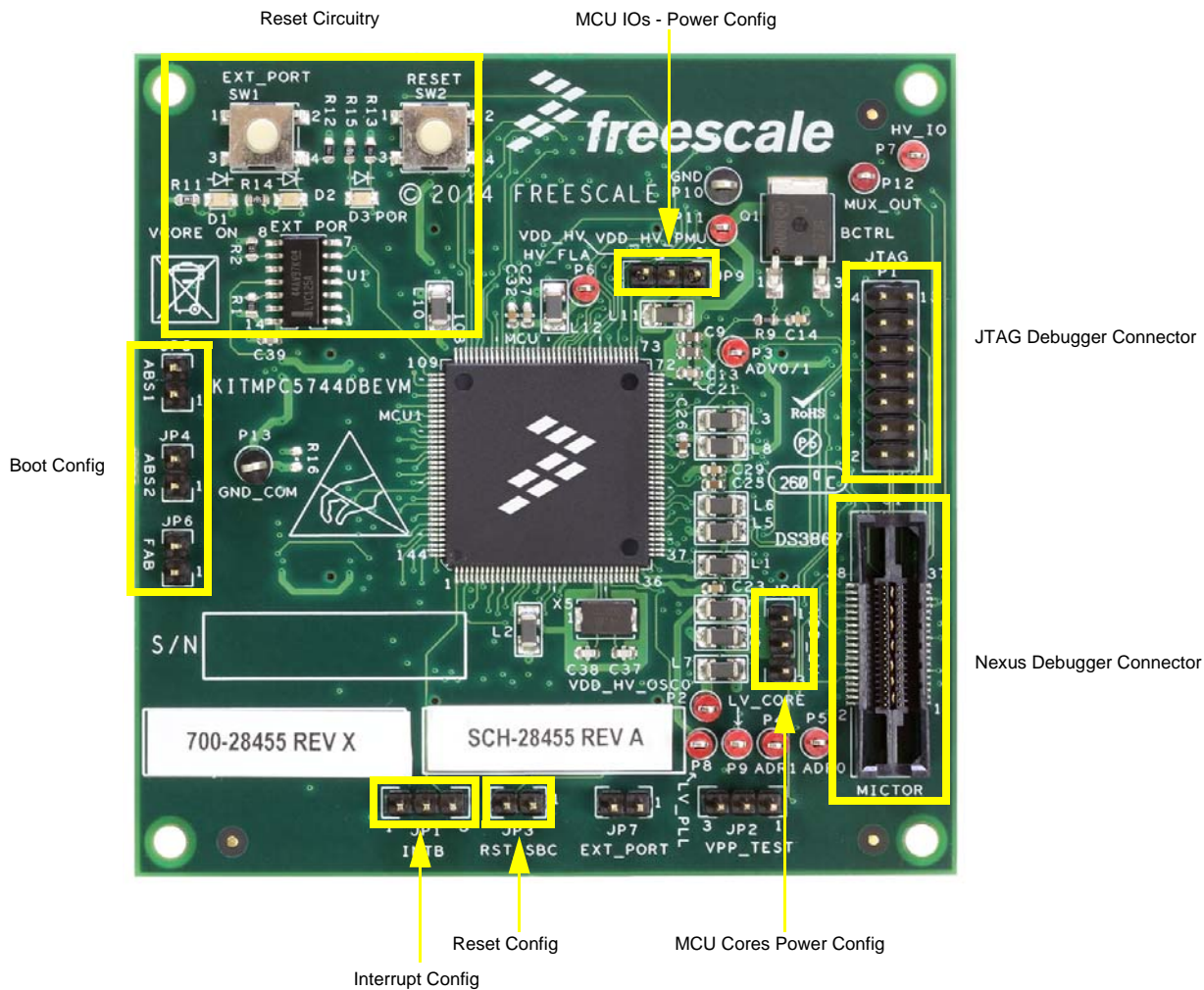

Figure 3. KITMPC5744DBEVM Board Description

3.4.1 LED Definitions

Table 2 LEDs are provided as visual output devices for the KITMPC5744DBEVM evaluation board:

Table 2. LEDs

Schematic Label	Signal/Rail	Description
D1	VCORE_ON	V _{CORE} power supply from the mother board
D2	EXT_POR	External Power On Reset
D3	POR	Functional reset (connected to the mother board)

3.4.2 Test Point Definitions

Table 3 test-point jumpers provide access to signals:

Table 3. Test Points

Schematic Label	Signal/Rail	Description
P2	VDD_HV_OSC0	High voltage power supply for the internal oscillator
P3	ADV0/1	High voltage supply for the ADC modules
P4	ADR1	ADC1 High reference voltage
P5	ADR0	ADC0 High reference voltage
P6	HV_FL A	Power Supply and decoupling pin for flash memory
P7	HV_IO	High voltage Power supply for the I/Os
P8	LV_PLL	Low voltage power supply for the PLL module
P9	LV_CORE	Low voltage power Supply
P10	GND	Ground
P11	VDD_HV_PMU	PMU high voltage Supply
P12	MUX_OUT	Analog signal coming from the Mother board
P13	GND_COM	Analog ground

3.4.3 Connector Definitions

Table 4. Connectors

Connector	Description
P1	JTAG debugger interface
J1	Nexus debugger interface
X1	Interface to the mother board
X2	Interface to the mother board
X3	Interface to the mother board
X4	Interface to the mother board

3.4.4 Jumper and Switch Definitions

Table 5 defines the evaluation board jumper positions and explains their functions. For each jumper a default setting is shown on the left side.

Table 5. Jumpers and Switches





Schematic Label	Setting	Description
JP1	INTb_SEL – selection of the MCU interrupt pin	
	1-2	INTb pin from the MC3390x is connected to a standard EIRQ interrupt pin of the MCU (PA0)
	2-3	INTb pin from MC3390x is connected to the NMI (Non Maskable Interrupt) pin of the MCU
JP2	VPP_TEST – SoC Test Mode, See Table 6 for truth table	
	1-2	VPP_TEST pin is connected to the GND (Normal operation)
	2-3	VPP_TEST pin is connected the V _{DD_HV_IO}
JP3	RST_SBC – Connects RST coming from the SBC to the functional RESET of the MCU	
		
JP4	ABS2 – puts Alternate Boot Selector bit 1 to the Ground (for all possible configurations see Table 6).	
		
JP5	ABS1 – puts Alternate Boot Selector bit0 to the Ground (for all possible configurations see Table 6).	
		
JP6	FAB – deactivates the Force Alternate Boot Mode (for all possible configurations see Table 6).	
		
JP7	EXT_PORT – connects external Power On Reset of the MCU to an external port (to the mother board)	
		

Table 5. Jumpers and Switches (continued)

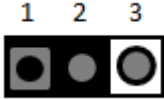
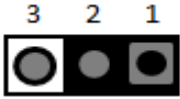

Schematic Label	Setting	Description
JP8	VDD_LV – power supply for the PLL and cores ($V_{DD_LV_PLL}$ and $V_{DD_LV_CORE}$)	
	1-2	The V_{CORE} coming from the motherboard is used directly – if this option is used, the V_{CORE} on the motherboard must be configured to 1.2 V, otherwise the MCU can be damaged!
	2-3	The $V_{DD_LV_xxx}$ will be supplied from V_{CORE} coming from motherboard using an external ballast to generate 1.2 V (V_{CORE} is configured on the motherboard to 3.3 V).
JP9	VDD_HV – power supply for the MCU's IOs ($V_{DD_HV_IO}$ and some other peripherals – see schematics for details)	
	1-2	The V_{CORE} is used (is configured to 3.3 V)
	2-3	The V_{CCA} is used
JP10	ADV0/1 – power supply for the ADC module	
	1-2	The V_{CORE} is used
	3-4	The V_{CCA} is used

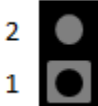
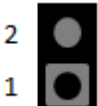
Table 6. Boot Mode Truth Table

FAB	ABS[2,0]	Boot Mode
1	00	UART
1	01	CAN

3.4.5 Reset Circuit

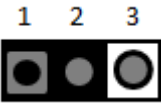
In the safety applications, the RESET pin of the MCU is controlled directly by the MC33907_8. The debugger must have a full control over the RESET pin, for debugging purposes. Reset signals coming from the JTAG and Nexus debug interfaces are connected directly to the reset of the MC33907_8, and this common signal ("RESET_PWSBC_B") is connected to the functional reset of the MCU. This means any of the three signals can cause a functional reset of the MCU (see Figure 4 for details).

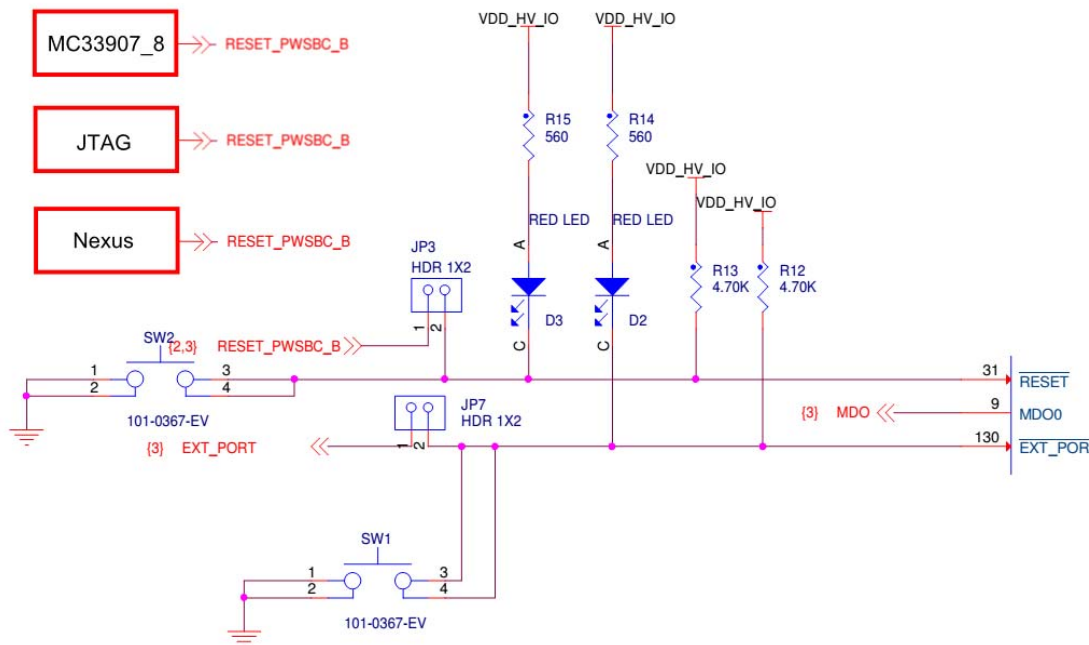

Figure 4. Reset Circuit

3.5 Interfacing with the Mother Board

3.5.1 Power Supplies

Power supply (power management) for the daughter board is completely provided by the mother board. Consequently, the mother board must be configured in a compatible way.

Caution:

Incorrect configuration of power supplies can damage the MCU.

The flexibility of the MC33907_8 power management circuit provides more possible configurations in how to interface with the MPC5744P. Two of them are described with the following.

1. The first configuration provides directly 1.2 V from the MC33907_8 to the VDD_LV_XX (for the cores and the PLL). In this configuration, the external ballast populated on the daughter board is not used. This provides a more efficient solution, 1.2 V will be provided directly from the DC-DC and not from an LDO (power is saved normally dissipated by the external ballast transistor). Configuration is described in Table 7.
2. In the second case, the reference voltage for the ADC is configured to 5.0 V. The rest of the circuits are supplied from the VCORE which is configured to provide 3.3 V. All the low voltage power supplies (VDD_LV_XX) are supplied from external ballast providing 1.2 V from the VCORE (see Table 8).

Table 7. Power Supply Settings - scenario 1

V _{CCA}	V _{CORE}	KIT33908MBEVBE Settings				KITMPC5744DBEVM Settings		
		JP104	JP114	JP122	S101	JP8	JP9	JP10
3.3 V	1.2 V	VCORE_EN	VCORE_SEL	VDDIO_SEL	VCCA/VAUX	VDD_LV	VDD_HV	HV_ADV
		connected	3-4	1-2	1-8 (V _{AUX} = 3.3 V) or 3-6 (V _{AUX} = 5.0 V)	1-2	2-3	2-3
		V _{DD_HV_PMU}	V _{DD_LV_COR}					
V _{DD_HV_IO}	V _{DD_LV_CORx}							
V _{DD_HV_FL A}	V _{DD_LV_PLL}							
V _{DD_HV_OSC}								
V _{DD_HV_ADRE0}								
V _{DD_HV_ADRE1}								
V _{DD_HV_ADV}								

Table 8. Power Supply Settings - scenario 2

V _{CCA}	V _{CORE}	V _{CORE} + Ext. Ballast	KIT33908MBEVBE Settings				KITMPC5744DBEVM Settings		
			JP104	JP114	JP122	S101	JP8	JP9	JP10
5.0 V	3.3 V	1.2 V	VCORE_EN	VCORE_SEL	VDDIO_SEL	VCCA/VAUX	VDD_LV	VDD_HV	HV_ADV
			connected	1-2	2-3	2-7 (V _{AUX} = 5.0 V) or 4-5 (V _{AUX} = 3.3 V)	2-3	1-2	1-2
			V _{DD_HV_ADRE0}	V _{DD_HV_PMU}	V _{DD_LV_COR}				
V _{DD_HV_ADRE1}	V _{DD_HV_IO}	V _{DD_LV_CORx}							
	V _{DD_HV_FL A}	V _{DD_LV_PLL}							
	V _{DD_HV_OSC}								
	V _{DD_HV_ADV}								

Mother Board - Power Management

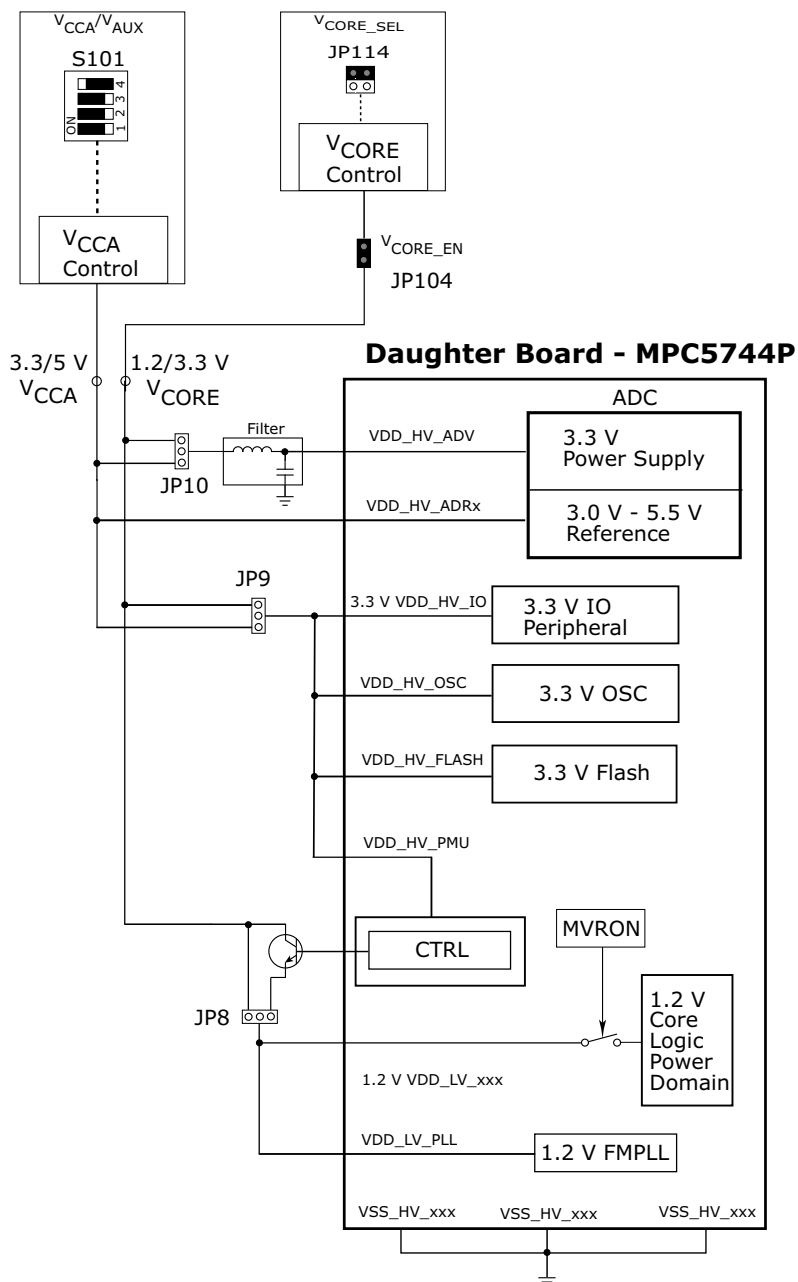

Figure 5. Power Supplies - Configuration of the Mother Board

3.5.2 Peripherals

Port mapping between peripherals on the mother and daughter boards is shown in [Table 9](#).

Table 9. Port Mapping Between Mother Board and the KITMPC5744DBEVM Daughter Board

Module/Pin	Pin function	MCU port	Jumper setting		MCU	
			Mother board	Daughter board	Pin	Module name
SPI	MOSI	PORTC			C[6]	DSPI_0
	MISO				C[7]	
	CLK				C[5]	
	NCS				C[4]	
ADC	Mux_OUT	PORTB			B[7]/AN[0]	ADC_0
	POT	PORTC			JP300	B[13]/AN[0]
UART	Tx	PORTD	JP304		D[9]	LINFlex_1
	Rx		JP305		D[12]	
$\overline{\text{INT}}$	EIRQ	PORTA		JP1	A[0]/REQ0	
	NMI				/NMI	
RSTb				JP3	RESET	
FCCU	FCCU[0]		JP110		FCCU_F[0]	FCCU
	FCCU[1]		JP109		FCCU_F[1]	
SIUL	SW1	PORTA	JP306		A[5]	SIUL
	SW2				A[6]	
	SW3				A[7]	
	SW4				A[8]	
	LED1	PORTD	JP307		D[4]	
	LED2				D[5]	
	LED3				D[6]	
	LED4				D[7]	
CAN	Tx	PORTB			B[0]	FlexCAN[0]
	Rx				B[1]	
LIN	Tx	PORTB			B[2]	LINFlex_0
	Rx				B[3]	

4 Installing the Software and Setting up the Hardware

4.1 Installing the GUI on your Computer

The Graphical User Interface (GUI) software is dedicated to the MC33907_8 development boards. To install the GUI successfully please follow these steps:

1. Make sure that the KIT33908MBEVBE is disconnected from the PC.
2. Launch “setup.exe” as shown in [Figure 6](#).

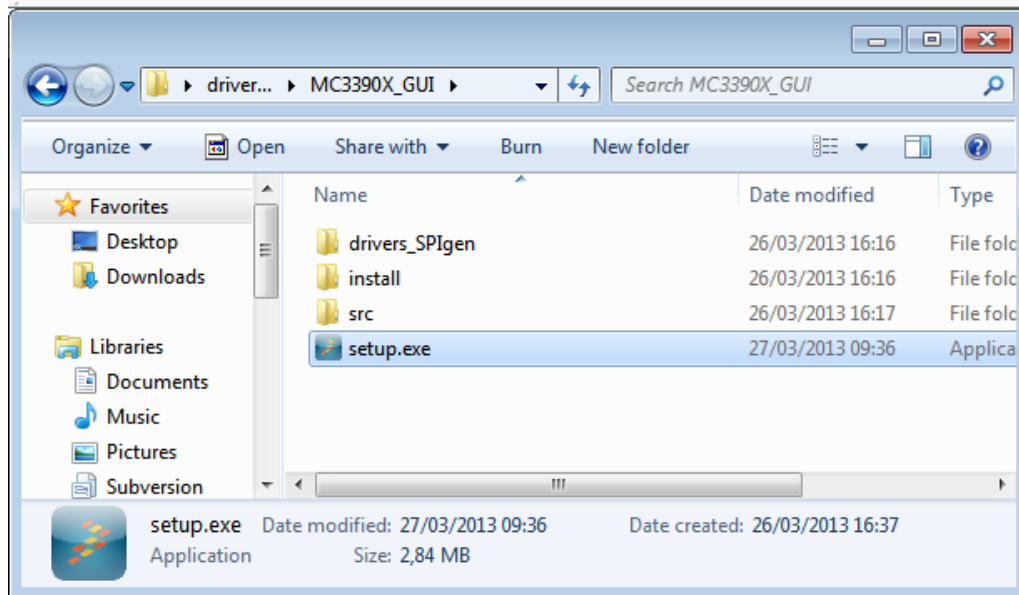

Figure 6. GUI Installation

3. Follow instructions of the automatic installer.
4. Connect the KIT33908MBEVBE to the PC – installation of the drivers starts automatically.
5. Launch the GUI when the installation is finished (restart is not required).

4.2 Configuring the Hardware

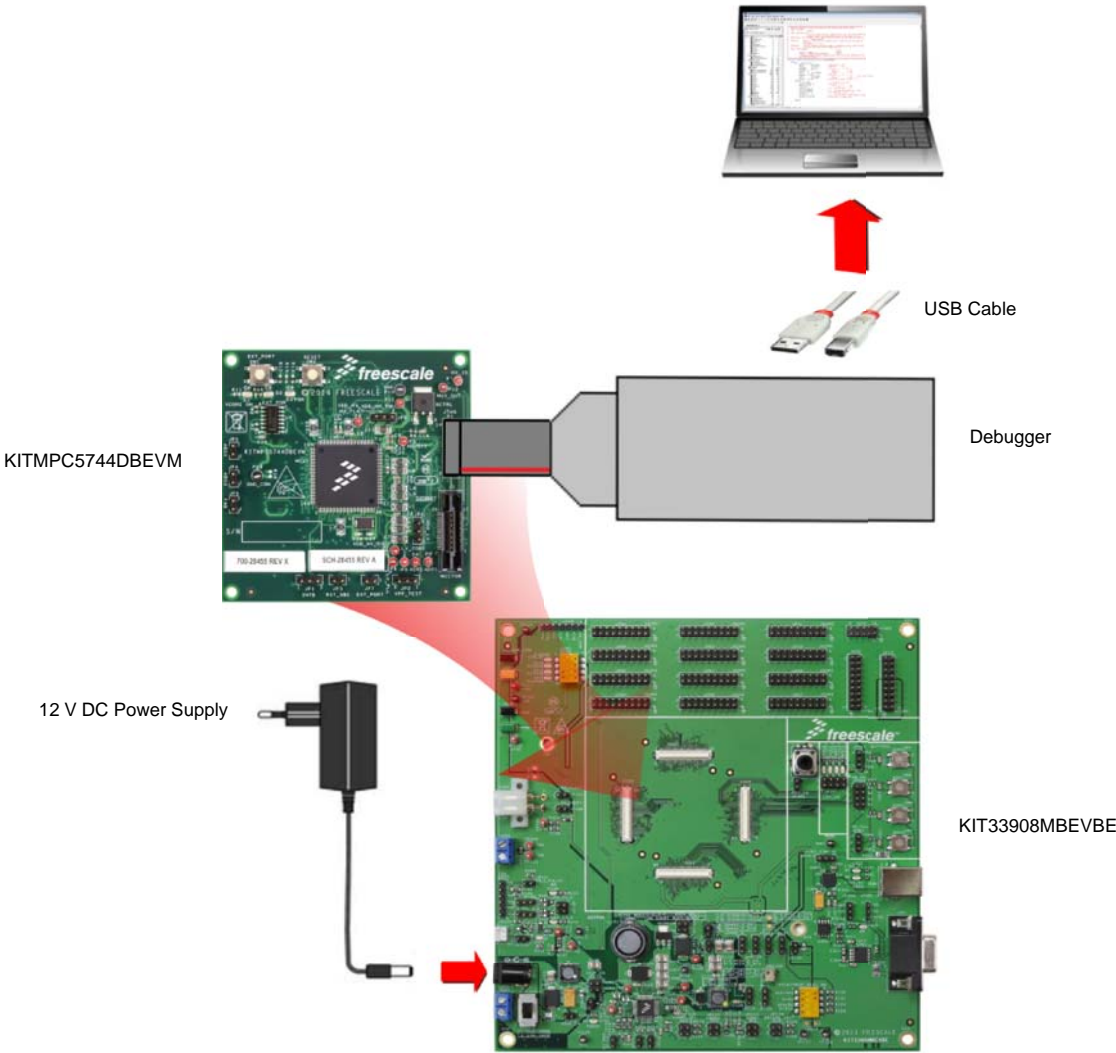

Figure 7. Recommended Configuration for Software Development

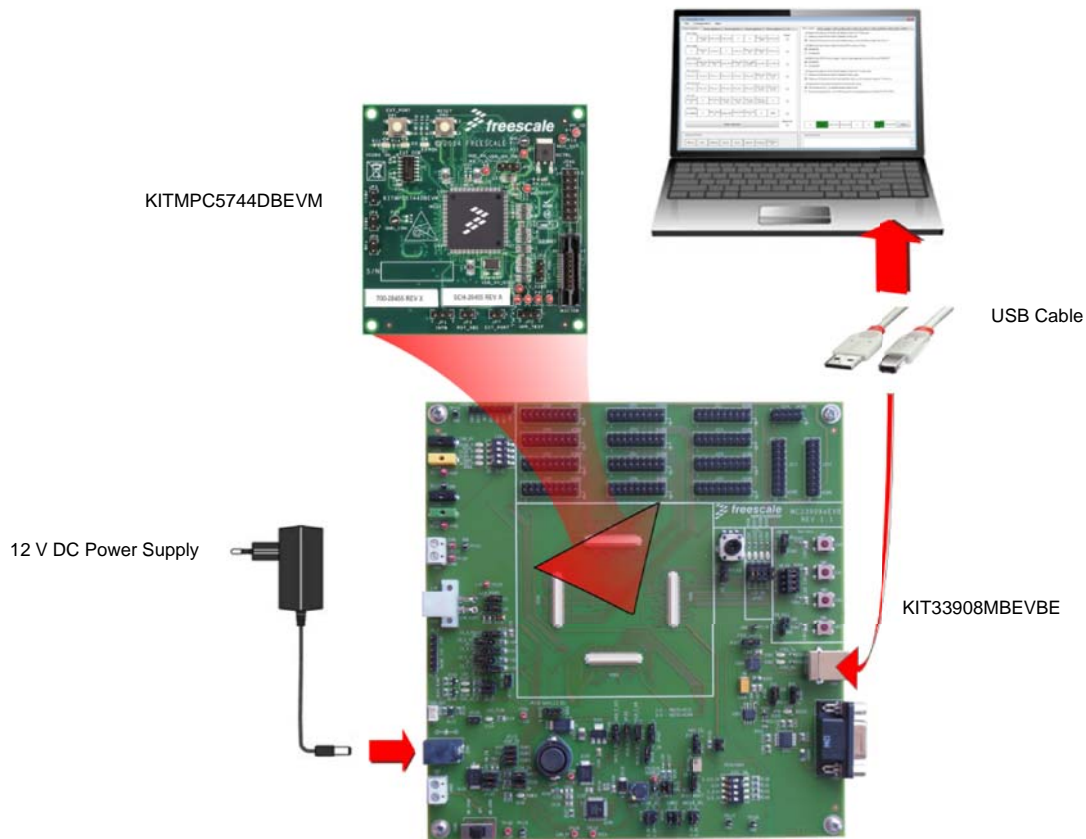

Figure 8. Recommended Configuration for Hardware Development

4.3 Step-by-Step Instructions for Setting Up the Hardware Using the GUI

In order to perform the demonstration examples, first set up the evaluation board hardware and software as follows:

1. Install the MC33907_8 graphical user interface.
2. Plug-in the daughter board (KITMPC5744DBEVM) to the mother board platform (KIT33908MBEVBE).
3. Connect the power supply to the mother board and switch it on (verify the polarity of the power supply first).
4. Connect the mother board to the PC using a USB A-B cable.
5. Wait for the driver installation to complete (after the first connection, drivers for the device have to be installed). This takes several minutes.
6. When the installation is complete, a status message is displayed.
7. Launch the MC33907_8 GUI.
8. Click the EVM button on the welcome screen to choose the enhanced evaluation board option.
9. Click on the tab called "Read register 5". If the board works properly, the bits of the WD_LFSR register move randomly.

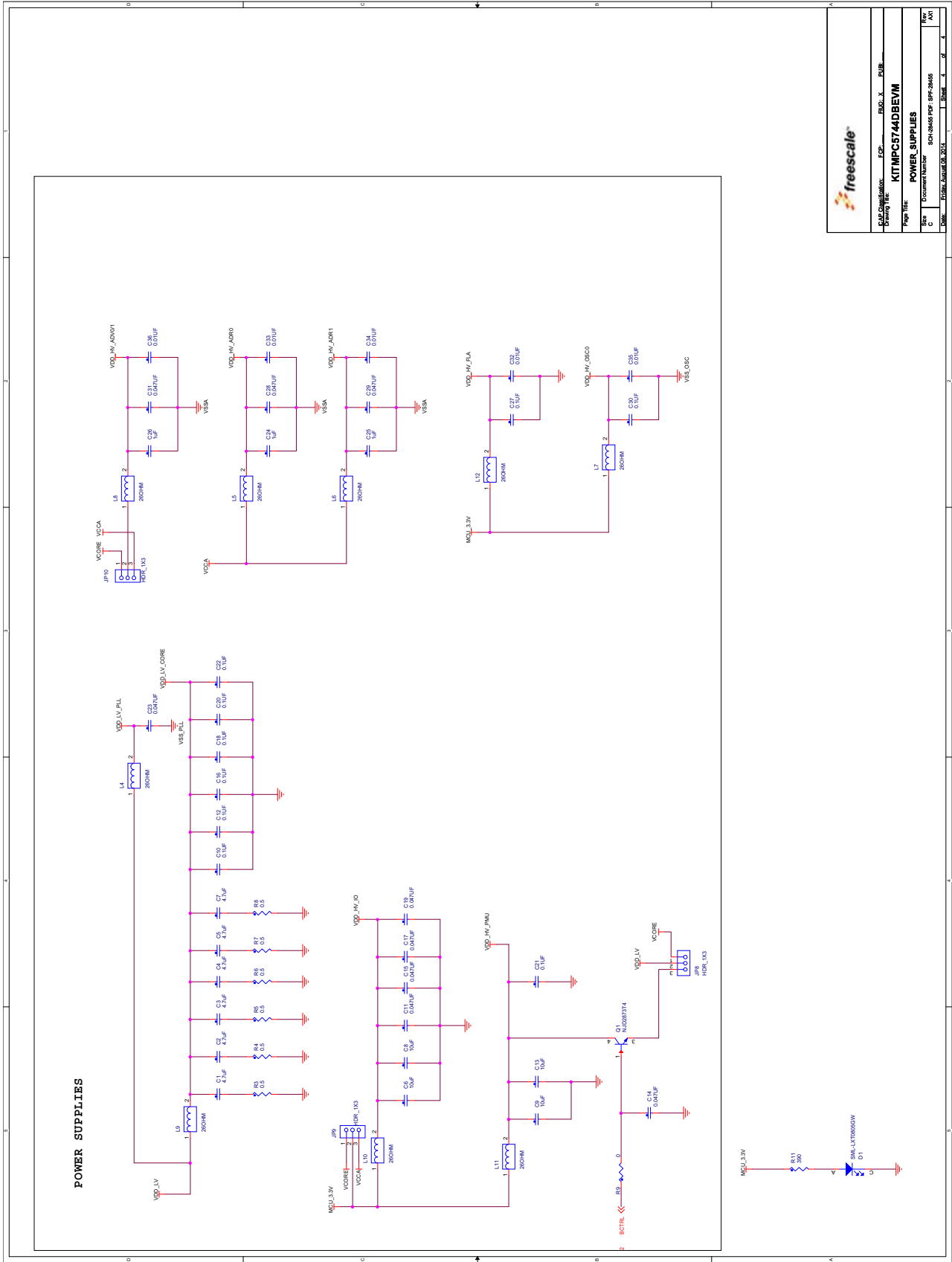
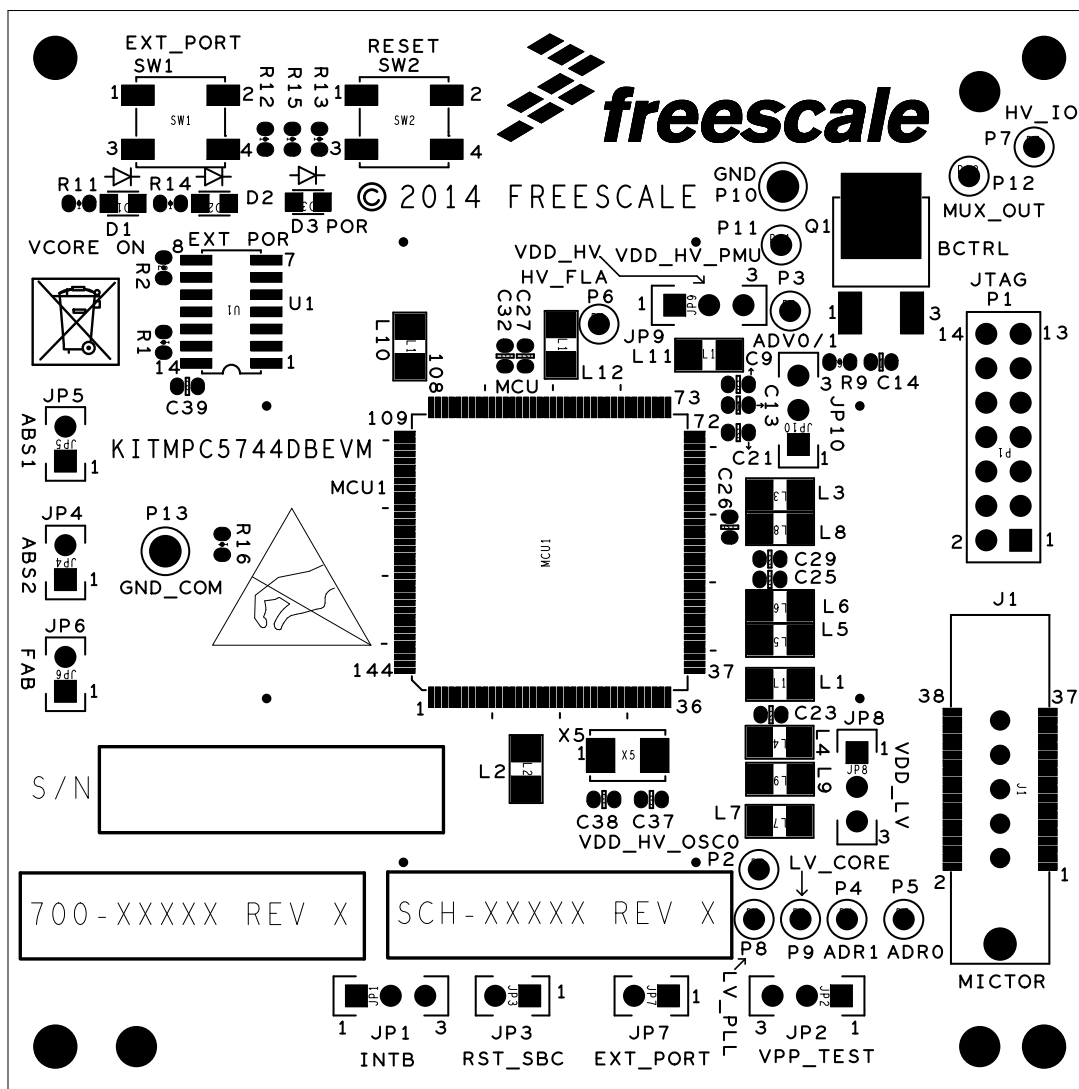

Figure 11. Evaluation Board Schematic, Part 3

Doc. Compliance:	FCP
Doc. Name:	KTMP5744DBEVM
Doc. Rev:	1.0
Doc. Date:	08/2014
Doc. Type:	POWER SUPPLIES
Doc. Number:	SC4-2648 Pwr-SF-2648
Doc. Size:	1.00 MB
Doc. Path:	...

6 Board Layout

6.1 Silkscreen Top



6.2 Silkscreen Bottom

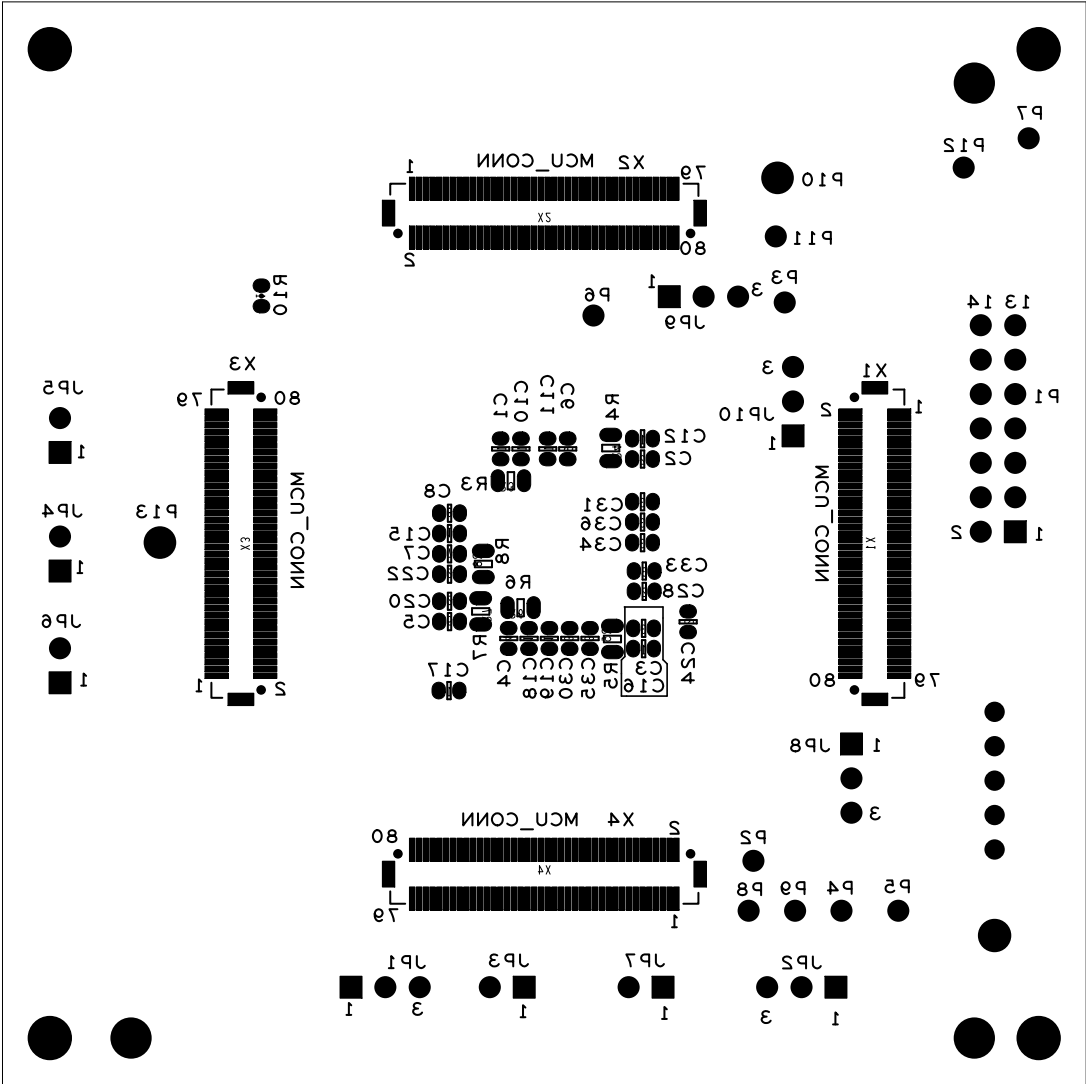

7 Bill of Materials

Table 10. Bill of Materials ⁽¹⁾

Item	Qty	Schematic Label	Value	Description	Part Number	Assy Opt
Active Components						
1	1	U1		IC BUF QUAD TS 1.2 V - 3.6 V SO14	74LVC125AD	
2	1	MCU1		IC MCU 32 BIT 2.5 MB FLASH 384 KB SRAM 3.3 V LQFP144	PPC5744PFK0AMLQ8	
Resistors						
3	3	R1, R2, R10	10 K	RES MF 10 K 1/10 W 5% 0603	RK73B1JTDD103J	
4	6	R3, R4, R5, R6, R7, R8	0.5 Ω	RES MF 0.50 Ω 1/8 W 1% 0805	RL0805FR-070R5L	
5	1	R9	0 Ω	RES MF 0 Ω 1/10 W 1% 0603	MC0603SAF0000T5E	
6	1	R11	390 Ω	RES MF 390 Ω 1/10 W 5% 0603	RK73B1JTDD391J	
7	2	R12, R13	4.70 K	RES MF 4.7 K 1/4 W 1% AEC-Q200 0603	CRCW06034K70FKEAHP	
8	2	R14, R15	560 K	RES MF 560 K 1/10 W 5% 0603	RK73B1JTDD561J	
9	1	R16	0 Ω	RES MF 0 Ω 1/10 W 1% 0603	MC0603SAF0000T5E	(2)
Capacitors						
10	6	C1, C2, C3, C4, C5, C7	4.7 μ F	CAP CER 4.7 μ F 25 V 10% X5R 0603	GRM188R61E475KE11D	
11	4	C6, C8, C9, C13	10 μ F	CAP CER 10 μ F 25 V 20% X5R 0603	GRM188R61E106MA73D	
12	10	C10, C12, C16, C18, C20, C21, C22, C27, C30, C39	0.1 μ F	CAP CER 0.1 μ F 50 V 10% X7R 0603	GRM188R71H104KA93D	
13	9	C11, C14, C15, C17, C19, C23, C28, C29, C31	0.047 μ F	CAP CER 0.047 μ F 25 V 10% X7R 0603	C0603X7R250-473KNE	
14	3	C24, C25, C26	1 μ F	CAP CER 1 μ F 25 V 10% X7R 0603	0603X105K250SNT	
15	5	C32, C33, C34, C35, C36	0.01 μ F	CAP CER 0.01 μ F 50 V 10% X7R 0603	C0603X7R500-103KNE	
16	2	C37, C38	10 pF	CAP CER 10 pF 50 V 10% X7R 0603	06035C100KAT2A	
Diodes						
17	1	D1	SML-LXT0805 GW	LED GRN SGL 2 V 20 MA SMT 0805	SML-LXT0805GW-TR	
18	2	D2, D3	RED LED	LED RED SGL 30 MA SMT 0805	SML-LXT0805IW-TR	
Connectors						
19	5	JP1, JP2, JP8, JP9, JP10	HDR_1X3	HDR 1X3 TH 100 MIL SP 338H AU 150L	HMTSW-103-24-S-S-230	
20	5	JP3, JP4, JP5, JP6, JP7	HDR 1X2	HDR 1X2 TH 100 MIL SP 165H AU	TLW-102-06-G-S	
21	1	J1	CON_2X19	CON 2X19 SKT SMT 25 MIL SP AU MICTOR	5767061-1	
Inductors						
22	12	L1, L2, L3, L4, L5, L6, L7, L8, L9, L10, L11, L12	26 Ω	IND FER BEAD 26 Ω 100 MHZ 1.5 A 25% 1206	MI1206K260R-10	
Test Points						
23	1	P1	HDR 2X7	HDR 2X7 TH 100 MIL CTR 330H SN 115L	TSW-107-23-T-D	
24	10	P2, P3, P4, P5, P6, P7, P8, P9, P11, P12	TEST POINT RED	TEST POINT RED 40 MIL DRILL 180 MIL TH 109L	5000	
25	2	P10, P13	5006	TEST POINT BLK 70X220 MIL TH	5006	
Transistors						
26	1	Q1	NJD2873T4	TRAN NPN PWR BJT 2 A 50 V DPAK	NJD2873T4G	

Table 10. Bill of Materials ⁽¹⁾ (continued)

Item	Qty	Schematic Label	Value	Description	Part Number	Assy Opt
Switches						
27	2	SW1, SW2	101-0367-EV	SW SPST MOM NO PB 50 MA 12 V SMT	101-0367-EV	
Jumpers						
28	4	X1, X2, X3, X4	CON 2X40 HDR	CON 2X40 HDR SMT 0.5 MM SP 99 H AU	DF12 (3.0)-80DP-0.5V (86)	
Crystal						
29	1	X5	40 MHZ	XTAL 40 MHZ -- -- SMT	NX5032GA-40.000000MHZ-L N-CD-1	

Notes

1. Freescale does not assume liability, endorse, or warrant components from external manufacturers are referenced in circuit drawings or tables. While Freescale offers component recommendations in this configuration, it is the customer's responsibility to validate their application.
2. Do not populate.
3. **Critical components.** For critical components, it is vital to use the manufacturer listed.

8 References

Freescale.com Support Pages	Description	URL
KITMPC5744DBEVM	Tool Summary Page	http://www.freescale.com/webapp/sps/site/prod_summary.jsp?code=KITMPC5744DBEVM
MC33908	Product Summary Page	http://www.freescale.com/webapp/sps/site/prod_summary.jsp?code=MC33908
KIT33908MBEVBE	Tool Summary Page	http://www.freescale.com/webapp/sps/site/prod_summary.jsp?code=KIT33908MBEVBE
MPC564xL	Product Summary Page	http://www.freescale.com/webapp/sps/site/prod_summary.jsp?code=MPC564xL
	Analog Home Page	http://www.freescale.com/analog
	Automotive Home Page	http://www.freescale.com/automotive

8.1 Support

Visit www.freescale.com/support for a list of phone numbers within your region.

8.2 Warranty

Visit www.freescale.com/warranty for a list of phone numbers within your region.

9 Revision History

Revision	Date	Description of Changes
1.0	2/2015	• Initial Release



How to Reach Us:

Home Page:
freescale.com

Web Support:
freescale.com/support

Information in this document is provided solely to enable system and software implementers to use Freescale products. There are no express or implied copyright licenses granted hereunder to design or fabricate any integrated circuits based on the information in this document.

Freescale reserves the right to make changes without further notice to any products herein. Freescale makes no warranty, representation, or guarantee regarding the suitability of its products for any particular purpose, nor does Freescale assume any liability arising out of the application or use of any product or circuit, and specifically disclaims any and all liability, including without limitation consequential or incidental damages. "Typical" parameters that may be provided in Freescale data sheets and/or specifications can and do vary in different applications, and actual performance may vary over time. All operating parameters, including "typicals," must be validated for each customer application by customer's technical experts. Freescale does not convey any license under its patent rights nor the rights of others. Freescale sells products pursuant to standard terms and conditions of sale, which can be found at the following address: freescale.com/SalesTermsandConditions.

Freescale and the Freescale logo, Energy Efficient Solutions, and the SafeAssure, logo are trademarks of Freescale Semiconductor, Inc., Reg. U.S. Pat. & Tm. Off. SMARTMOS is a trademarks of Freescale Semiconductor, Inc. All other product or service names are the property of their respective owners.

© 2015 Freescale Semiconductor, Inc.

Document Number: KT MPC5744DBUG
Rev. 1.0
2/2015



X-ON Electronics

Largest Supplier of Electrical and Electronic Components

Click to view similar products for [Daughter Cards & OEM Boards](#) category:

Click to view products by [NXP](#) manufacturer:

Other Similar products are found below :

[ADZS-21262-1-EZEXT](#) [27911](#) [KITMPC5744DBEVM](#) [SPC56ELADPT144S](#) [TMDXRM46CNCD](#) [DM160216](#) [MPC5777M-416DS](#) [EV-ADUCM350GPIOTHZ](#) [EV-ADUCM350-BIO3Z](#) [ATSTK521](#) [1130](#) [MA160015](#) [MA180033](#) [MA240013](#) [MA240026](#) [MA320014](#) [MA330014](#) [MA330017](#) [TLK10034SMAEVM](#) [MIKROE-2152](#) [MIKROE-2154](#) [MIKROE-2381](#) [TSSOP20EV](#) [DEV-11723](#) [MIKROE-1108](#) [MIKROE-1516](#) [SPS-READER-GEVK](#) [AC244049](#) [AC244050](#) [AC320004-3](#) [2077](#) [ATSMARTCARD-XPRO](#) [EIC - Q600 -230](#) [ATZB-212B-XPRO](#) [SPC560PADPT100S](#) [SPC560BADPT64S](#) [MA180018](#) [EIC - Q600 -220](#) [AC164134-1](#) [BOB-12035](#) [BB-BONE-BATT-01](#) [STM8/128-D/RAIS](#) [AC164127-6](#) [AC164127-4](#) [AC164134-3](#) [AC164156](#) [MA320021](#) [MA320024](#) [DFR0285](#) [DFR0312](#)