

MC13852

MC13852

General Purpose Low Noise Amplifier with Bypass Switch

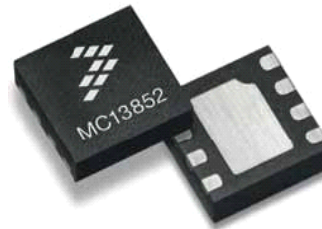

Package Information
Plastic Package: MLPD-8
2.0 x 2.0 x 0.6 mm
Case: 2128-01

Ordering Information

Device	Device Marking	Package
MC13852EP	852	MLPD-8

1 Introduction

The MC13852 is a cost-effective high gain LNA with low noise figure. This is the lower application frequency version of the MC13851.

An integrated bypass switch is included to preserve high input intercept performance in variable signal strength environments and boosts dynamic range. On-chip bias circuitry offers low system cost. The input and output match are external to allow maximum design flexibility. The external resistor used to set device current enables balancing required linearity with low current consumption. Gain is optimized for applications <1000 MHz.

The MC13852 is fabricated with an advanced RF BiCMOS process using the eSiGe:C module and is available in the 2 × 2 mm MLPD-8 leadless package, offering a small, low height, easy-to-solder solution for applications with tight printed circuit board placement requirements.

Contents:

1 Introduction	1
2 Electrical Specifications	3
3 Applications Information	8
4 Printed Circuit Board and Bills of Materials	14
5 Scattering and Noise Parameters	18
6 Packaging	27
7 Product Documentation	28
8 Revision History	28

This document contains information on a new product. Specifications and information herein are subject to change without notice.

© Freescale Semiconductor, Inc., 2006–2010. All rights reserved.

1.1 Features

- The MC13852 is intended for applications from 400 to 1000 MHz; the MC13851 is for applications >1000 MHz.
- Gain: 20.3 dB (typ) at 434 MHz, 18.7 dB (typ) at 900 MHz.
- Output third order intercept point (OIP3): 10.6 dBm at 434 MHz, 14.2 dBm (typ) dBm at 900 MHz.
- Noise Figure (NF): 1.65 dB (typ) at 434 MHz, 1.2 dB at 900 MHz.
- Output 1 dB compression point (P1dB): 7.8 dBm (typ) at 434 MHz, 9.6 dBm (typ) at 900 MHz.
- IP3 Boost Circuitry.
- Bypass mode return losses are comparable to active mode, for use in systems with filters and duplexers.
- Bypass mode improves dynamic range in variable signal strength environments.
- Integrated logic-controlled standby mode with current drain < 1uA.
- Total supply current variable from 3–6 mA using an external bias resistor.
- Average current drain <0.6mA in a receiver lineup with 20% active / 80% bypass mode operation.
- On-chip bias sets the bias point.
- Bias stabilized for device and temperature variations.
- MLPD-8 leadless package with low parasitics.
- 434 MHz and 900 MHz application circuit evaluation boards with characterization data are available.
- Available in tape and reel packaging.

1.2 Applications

Ideal for use in any RF product that operates between 400 MHz and 1 GHz, and may be applied in:

- Buffer amplifiers
- Mixers
- IF amplifiers
- Voltage-controlled oscillators (VCOs)
- Use with transceivers requiring external LNAs
- RF smart metering
- Mobile: Cellular front-end LNA, 2-way radios
- Auto: RKE, key fob, TPMS
- Low current drain/long standby time for extended battery life applications

Figure 1 shows a simplified block diagram, with the pinouts and the location of the pin 1 marking on the package.

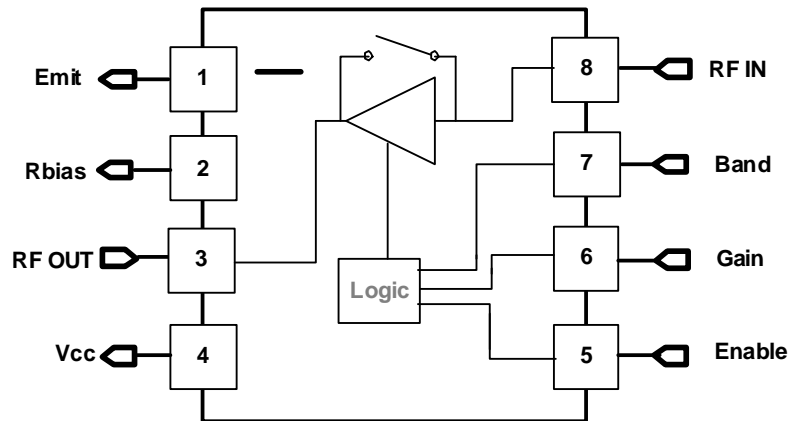

Figure 1. Simplified Block Diagram

2 Electrical Specifications

Table 1 lists the maximum ratings for the device.

Table 1. Maximum Ratings

Ratings	Symbol	Value	Unit
Supply Voltage	V_{CC}	3.3	V
Storage Temperature Range	T_{stg}	-65 to 150	°C
Operating Ambient Temperature Range	T_A	-30 to 85	°C
RF Input Power	P_{rf}	10	dBm
Power Dissipation	P_{dis}	100	mW
Thermal Resistance, Junction to Case	$R_{\theta JC}$	24	C/W
Thermal Resistance, Junction to Ambient, 4 Layer Board	$R_{\theta JA}$	90	C/W

- NOTES:**
- Maximum Ratings are those values beyond which damage to the device may occur. Functional operation should be restricted to the limits in the Recommended Operating Conditions and Electrical Characteristics tables.
 - ESD (electrostatic discharge) immunity meets Human Body Model (HBM) ≤ 200 V, Charge Device Model (CDM) ≤ 450 V, and Machine Model (MM) ≤ 50 V. Additional ESD data available upon request.

Table 2 lists the recommended operating conditions.

Table 2. Recommended Operating Conditions

Characteristic	Symbol	Min	Typ	Max	Unit
RF Frequency range	f_{RF}	400	—	1000	MHz
Supply Voltage	V_{CC}	2.3	2.75	3.0	Vdc
Logic Voltage	—	1.25	1.8	V_{CC}	Vdc
Input High Voltage	—	0	—	0.8	
Input Low Voltage	—	0	—	0.8	

Table 3 shows the use of the Gain, Enable and Band pins (along with the Vcc and RF out pins), to select Active mode (High Gain), Bypass mode (Low Gain), or Standby mode (Disable) operation.

Table 3. Truth Table

Pin Function	Pin Name	Enable		Disable	
		Low Gain	High Gain	Low Gain	High Gain
Logic Circuit Bias Vcc	Vcc	1	1	1	1
Toggles Gain Mode (Active or Bypass)	Gain	0	1	0	1
Toggles LNA On/Off	Enable	1	1	0	0
Selects the LNA	Band	1	1	1	1

NOTES: 1. Logic state "1" equals Vcc voltage. Logic state of "0" equals ground potential.
 2. Vcc is inductively coupled to LNA Out pin and Vcc pin.
 3. Minimum logic state "1" for enable and gain pins is 1.25V.
 4. Maximum logic state "0" for enable and gain pins is 0.8V.

Table 4 lists electrical characteristics associated with noise performance measured in a 50Ω system. Additional noise parameters are listed in Table 14 and Table 15. Also listed are the typical Icc and RF turn-on times for the device.

Table 4. Electrical Characteristics (Vcc = 2.75 V, Ta = 25°C)

Characteristic	Symbol	Min	Typ	Max	Unit
Insertion Gain R1=1.2 kΩ, Freq=434 MHz R1=1.2 kΩ, Freq=900 MHz	IS21 ²	20.4 16.4	21.9 18.3	—	dB
Maximum Stable Gain and/or Maximum Available Gain [Note1] R1=1.2 kΩ, Freq=434 MHz R1=1.2 kΩ, Freq=900 MHz	MSG, MAG	26.7 22	28.2 23.5	—	dB
Minimum Noise Figure R1=1.2 kΩ, Freq=434 MHz R1=1.2 kΩ, Freq=900 MHz	NFmin	—	0.92 0.84	1.2 1.1	dB
Associated Gain at Minimum Noise Figure R1=1.2 kΩ, Freq=434 MHz R1=1.2 kΩ, Freq=900 MHz	Gnf	27.6 21	29.6 23	—	dB
Icc and RF Turn On Time Enable trigger total time of 1.8 usec from 0 to 2.75 V Icc rise time from 0 to 76% of final current level Icc rise time from 0 to 87% of final current level RF on time from leading edge of enable trigger to RF turn-on	—	—	6.4 9.6 1.37	—	usec

NOTES: 1. Maximum Available Gain and Maximum Stable Gain are defined by the K factor as follows:
 MAG=IS21/S12(K+/-sqrt(K²-1)), if K>1,
 MSG =IS21/S12I, if K<1

Table 5 lists the electrical characteristics measured on evaluation boards that are tuned for typical application frequencies. Further details on the application circuits are shown in Section 4; details on the boards are shown in Section 5.

Table 5. Electrical Characteristics Measured in Frequency Specific Tuned Circuits

 ($V_{CC} = 2.775\text{ V}$, $T_A = 25^\circ\text{C}$, $R_{bias} = 2\text{ k}\Omega$, unless otherwise noted.)

Characteristic	Symbol	Min	Typ	Max	Unit
434 MHz					
Frequency	f	—	434	—	MHz
Active RF Gain	G	19.3	20.3	—	dB
Active Noise Figure	NF	—	1.65	1.95	dB
Active Input Third Order Intercept Point	IIP3	-10.7	-9.7	—	dBm
Active Output 1 dB Compression Point	P_{1dB}	6.8	7.8	—	dBm
Active Current @ 2.75 V, $R_{bias}=1.2\text{ k}\Omega$	I_{CC}	—	5.5	6.5	mA
Active Current @ 2.75 V, $R_{bias}=1.5\text{ k}\Omega$	I_{CC}	—	4.4	5.4	mA
Active Gain	S21	19	20.1	—	dB
Bypass RF Gain	G	-9.5	-8.5	—	dB
Bypass Noise Figure	NF	—	8.9	9.9	dB
Bypass Input Third Order Intercept Point	IIP3	24	25.1	—	dBm
Bypass Current	—	—	4	20	μA
Bypass Gain	S21	-9.5	-8.5	—	dB
900 MHz					
Frequency	f	—	900	—	MHz
Active RF Gain	G	17.6	18.6	—	dB
Active Noise Figure	NF	—	1.2	1.55	dB
Active Input Third Order Intercept Point	IIP3	-5.7	-4.4	—	dBm
Active Output 1 dB Compression Point	P_{1dB}	8.5	9.6	—	dBm
Active Current @ 2.75 V, $R_{bias}=1.2\text{ k}\Omega$	I_{CC}	—	5.5	6.5	mA
Active Current @ 2.75 V, $R_{bias}=1.5\text{ k}\Omega$	I_{CC}	—	4.4	5.4	mA
Active Gain	S21	17.5	18.5	—	dB
Bypass RF Gain	G	-6.7	-5.7	—	dB
Bypass Noise Figure	NF	—	6.1	7.1	dB
Bypass Input Third Order Intercept Point	IIP3	25	26.7	—	dBm
Bypass Current	—	—	4	10	μA
Bypass Gain	S21	-6.7	-5.7	—	dB

Figure 2 and Figure 3 show maximum stable and maximum available gain and forward insertion gain versus frequency for the packaged device in a 50Ω system using bias resistors of 1.5 kΩ and 1.2 kΩ.

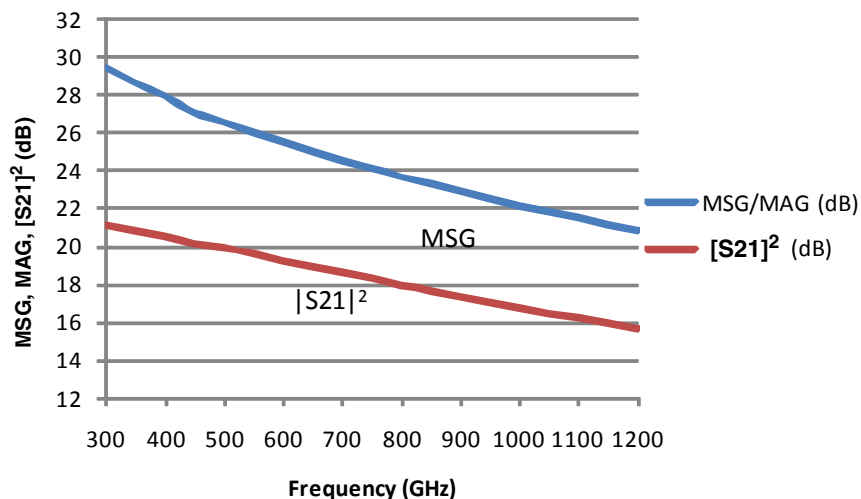

Figure 2. Maximum Stable/Available Gain and Forward Insertion Gain vs. Frequency, Rbias = 1.5 kΩ

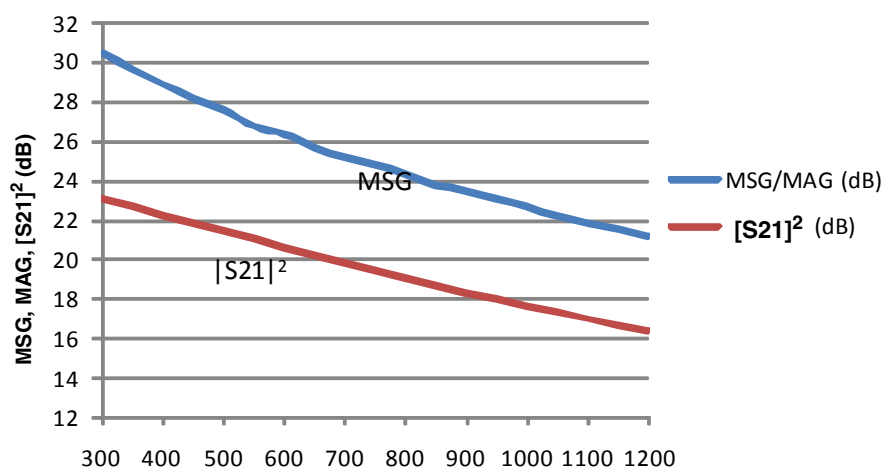

Figure 3. Maximum Stable/Available Gain and Forward Insertion Gain vs. Frequency, Rbias = 1.2 kΩ

Figure 4 and Figure 5 show minimum noise figure and associated gain versus frequency for the packaged device in a 50Ω system using bias resistors of 1.5 kΩ and 1.2 kΩ.

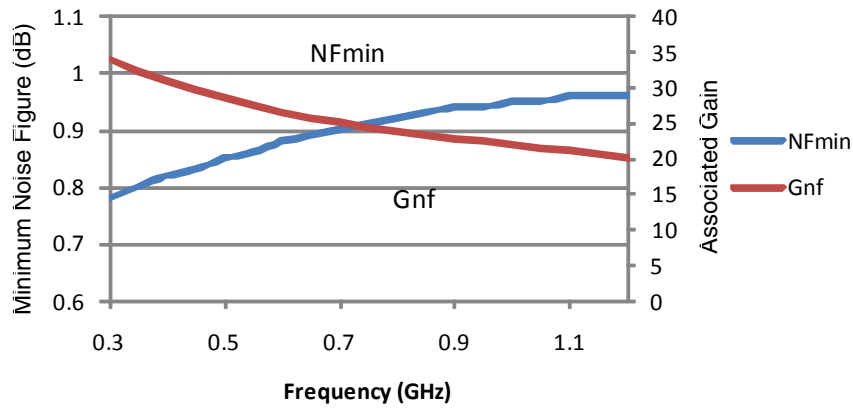

Figure 4. Minimum Noise Figure and Associated Gain vs. Frequency, R_{bias} = 1.5 kΩ

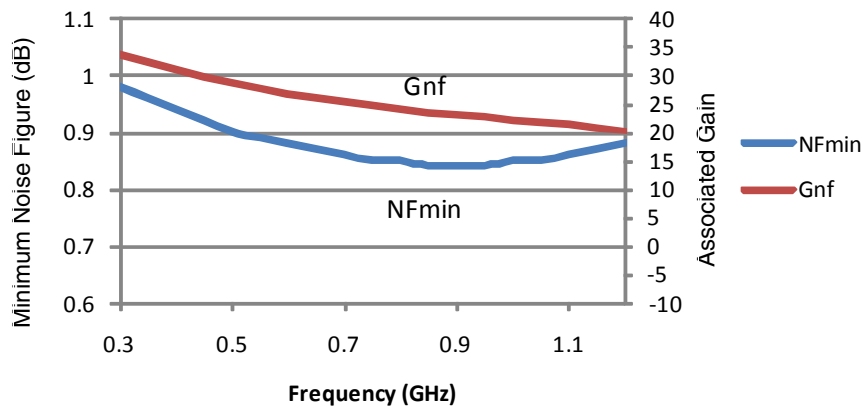

Figure 5. Minimum Noise Figure and Associated Gain vs. Frequency, R_{bias} = 1.2 kΩ

Figure 6 shows the I_{cc} current drain for a range of values for the external bias resistor R_{bias} .

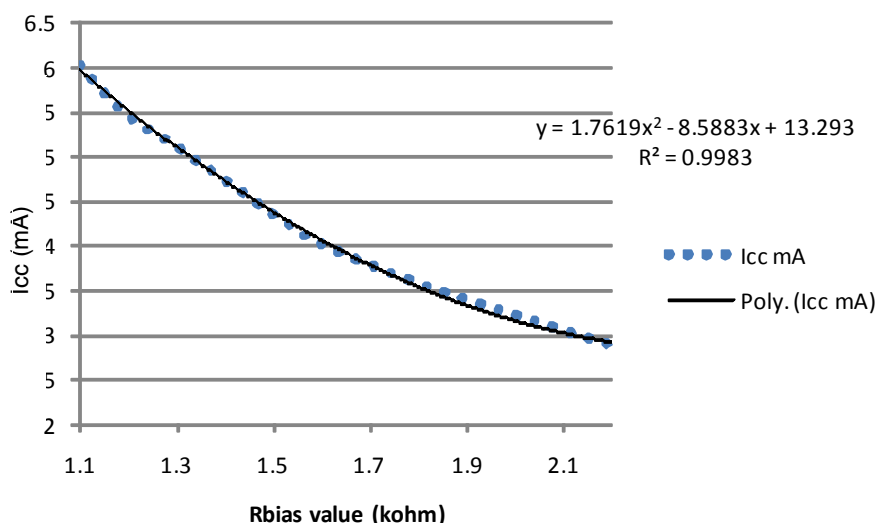

Figure 6. I_{cc} vs. Bias Resistor R1 Value

3 Applications Information

The MC13852 LNA is designed for applications in the 400 MHz to 1 GHz range. It has three different modes: High Gain, Low Gain (bypass) and Standby. The LNA is programmable through the Gain and Enable pins. The logic truth table is given in Table 3. The internal bypass switch is designed for broadband applications.

One of the advantages of the MC13852 is the simplification of the matching network in both bypass and amplifier modes. The bypass switch is designed so that changes of input and output return losses between bypass mode and active mode are minimized and the matching network design is simplified.

In these application examples, a balance is made between the competing RF performance characteristics of I_{cc} , NF, gain, IP3, and return losses with unconditional stability. Conjugate matching is not used for the input or output. Instead, matching which achieves a trade-off in RF performance qualities is used. For a particular application or specification requirement, the matching can be changed to achieve enhanced performance of one parameter.

Measurements are made at a bias of $V_{cc} = 2.75$ V. Frequency spacing for IP3 measurements is 200 kHz. Non-linear measurements are made at $P_{in} = -30$ dBm. Typical application circuits are provided for 434 MHz and 900 MHz applications. Typical RF performance is shown for two values of bias resistor R1: 1.2 k Ω and 1.5 k Ω . These two current drain levels offer variations in intercept point, gain and noise figure. Included with each application are the schematics and electrical performance.

- Section 4 provides the evaluation board layout and Bill of Material for the circuits.
- Section 5 provides Smith charts with gain and noise circles for each application frequency.

3.1 434 MHz Application

This application was designed to provide typical NF = 1.65 dB, S21 gain = 20 dB, OIP3 = 10.6 dBm at 434 MHz. Typical performance that can be expected from this circuit at 2.75 V is listed in Table 6. The component values can be changed to enhance the performance of a particular parameter, but usually at the expense of another. Two values of bias resistor R1 are shown to demonstrate performance for different IP3 and Icc requirements.

- Values of external resistor R1 are varied to adjust Icc and IP3.
- Inductor L3 provides bias to the logic circuit.

Figure 7 is the 434 MHz application schematic with package pinouts and the circuit component topology.

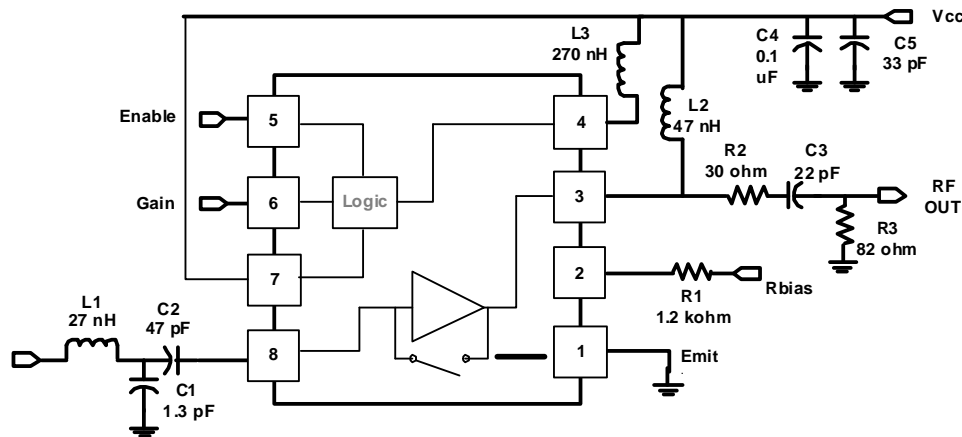

Figure 7. 434 MHz Application Schematic

Table 6. Typical 434 MHz Evaluation Board Performance (Vcc = 2.75V, TA = 25°C)

Characteristic	Symbol	Min	Typ	Max	Unit
R1 = 1.2 kΩ					
Frequency	f	—	434	—	MHz
RF Gain High Gain Bypass	G	19.3 -9.5	20.3 -8.5	— —	dB
Output Third Order Intercept Point High Gain Bypass	OIP3	9.5 15.5	10.6 16.6	— —	dBm
Input Third Order Intercept Point High Gain Bypass	IIP3	-10.7 24	-9.7 25.1	— —	dBm
Out Ref P1dB High Gain	P1dBout	6.8	7.8	—	dBm
In Ref P1dB High Gain	P1dBin	-13.5	-12.5	—	dBm

Table 6. Typical 434 MHz Evaluation Board Performance ($V_{CC} = 2.75V$, $T_A = 25^{\circ}C$) (continued)

Characteristic	Symbol	Min	Typ	Max	Unit
Noise Figure High Gain Bypass	NF	— —	1.65 8.9	1.95 9.9	dB
Current Draw High Gain Bypass	I_{CC}	— —	5.5 4	6.5 20	mA μA
Rbias R1 Value	—	—	1.2	—	k Ω
Input Return Loss High Gain Bypass	S11	— —	-6.7 -17	-5.5 -15	dB
Gain High Gain Bypass	S21	19 -9.5	20.1 -8.5	— —	dB
Reverse Isolation High Gain Bypass	S12	— —	-35.5 -8.6	-33.5 -6.5	dB
Output Return Loss High Gain Bypass	S22	— —	-14.5 -20.4	-12 -17	dB
R1 = 1.5 kΩ					
Frequency	f	—	434	—	MHz
RF Gain High Gain Bypass	G	18.5 -9.4	19.5 -8.4	— —	dB
Output Third Order Intercept Point High Gain Bypass	OIP3	6.8 15.4	7.9 16.5	— —	dBm
Input Third Order Intercept Point High Gain Bypass	IIP3	-12.6 23	-11.6 24.9	— —	dBm
Out Ref P1dB High Gain	P1dBout	5.2	6.2	—	dBm
In Ref P1dB High Gain	P1dBin	-14.3	-13.3	—	dBm
Noise Figure High Gain Bypass	NF	— —	1.6 8.7	1.9 9.7	dB
Current Draw High Gain Bypass	I_{CC}	— —	4.4 4	5.4 20	mA μA
Rbias R1 Value	—	—	1.5	—	k Ω

Table 6. Typical 434 MHz Evaluation Board Performance ($V_{cc} = 2.75V$, $T_A = 25^{\circ}C$) (continued)

Characteristic	Symbol	Min	Typ	Max	Unit
Input Return Loss					
High Gain	S11	—	-5.5	-4.5	dB
Bypass		—	-17.2	-15.5	
Gain					
High Gain	S21	18.3	19.3	—	dB
Bypass		-9.3	-8.3	—	
Reverse Isolation					
High Gain	S12	—	-35	-32	dB
Bypass		—	-8.3	-7.3	
Output Return Loss					
High Gain	S22	—	-13.9	-11	dB
Bypass		—	-20.4	-19	

3.2 900 MHz Application

This application circuit is designed to demonstrate performance at 900 MHz. Typical results of $NF = 1.2$ dB, S_{21} gain = 18.5 dB, and $OIP3$ of 14.2 dBm.

By varying the value of resistor $R1$, the current draw and $IP3$ performance of the device can be tailored for a particular application. Two values of bias resistor $R1$ are shown to demonstrate performance for different $IP3$ and I_{cc} requirements.

- Resistor $R3$ is used to de-Q output inductor $L2$ and adjust gain and return losses. Reducing $R3$ lowers gain and improves return losses.
- Inductor $L1$ can be raised in value at lower current operation to improve return losses.

Typical performance that can be expected from this circuit at 2.75 V is listed in [Table 7](#).

[Figure 8](#) is the 900 MHz application schematic with package pinouts and the circuit component topology.

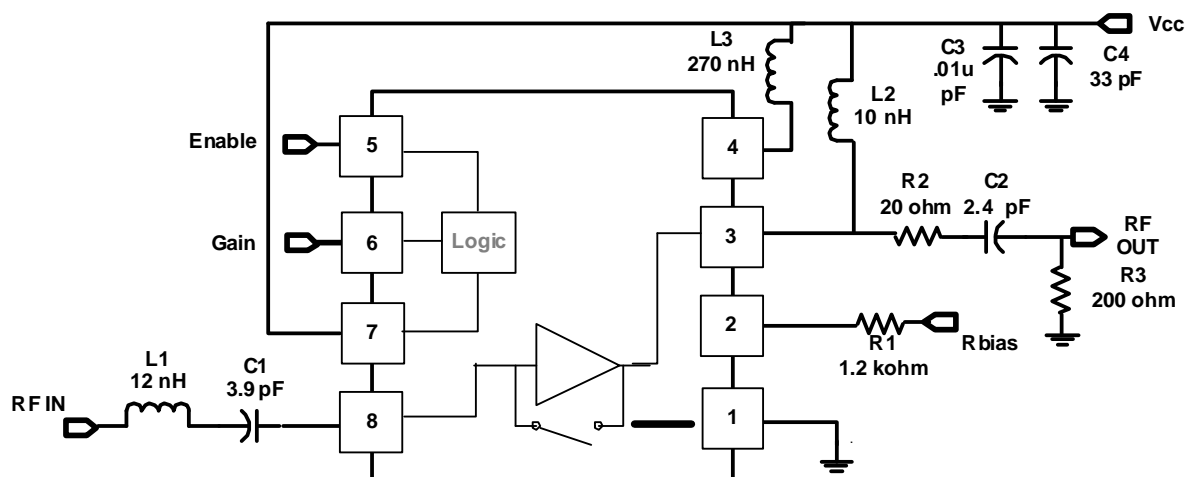

Figure 8. 900 MHz Application Schematic

Table 7. Typical 900 MHz Evaluation Board Performance (Vcc = 2.75V, TA = 25°C)

Characteristic	Symbol	Min	Typ	Max	Unit
R1 = 1.2 kΩ					
Frequency	f	—	900	—	MHz
RF Gain High Gain Bypass	G	17.6 -6.7	18.6 -5.7	— —	dB
Output Third Order Intercept Point High Gain Bypass	OIP3	13 19.5	14.2 21	— —	dBm
Input Third Order Intercept Point High Gain Bypass	IIP3	-5.4 25	-4.4 26.7	— —	dBm
Out Ref P1dB High Gain	P1dBout	8.5	9.6	—	dBm
In Ref P1dB High Gain	P1dBin	-9.9	-8.9	—	dBm
Noise Figure High Gain Bypass	NF	— —	1.2 6.1	1.55 7.1	dB
Current Draw High Gain Bypass	I _{CC}	— —	5.5 4	6.5 20	mA μA
Rbias R1 Value	—	—	1.2	—	kΩ
Input Return Loss High Gain Bypass	S11	— —	-8.8 -11	-7 -9	dB
Gain High Gain Bypass	S21	17.5 -6.7	18.5 -5.7	— —	dB
Reverse Isolation High Gain Bypass	S12	— —	-28 -5.7	-26.5 -4.7	dB
Output Return Loss High Gain Bypass	S22	— —	-13 -25	-10 -20	dB
R1 = 1.5 kΩ					
Frequency	f	—	900	—	MHz
RF Gain High Gain Bypass	G	17.2 -7.7	18.2 -5.7	— —	dB
Output Third Order Intercept Point High Gain Bypass	OIP3	12.1 19.8	13.1 21	— —	dBm

Table 7. Typical 900 MHz Evaluation Board Performance ($V_{CC} = 2.75V$, $T_A = 25^{\circ}C$) (continued)

Characteristic	Symbol	Min	Typ	Max	Unit
Input Third Order Intercept Point High Gain Bypass	IIP3	-6.2 25.5	-5.1 26.7	— —	dBm
Out Ref P1dB High Gain	P1dBout	8.5	9.9	—	dBm
In Ref P1dB High Gain	P1dBin	-10	-8.4	—	dBm
Noise Figure High Gain Bypass	NF	— —	1.18 6.1	1.5 7.1	dB
Current Draw High Gain Bypass	I_{CC}	— —	4.4 4	5.4 20	mA μA
Rbias R1 Value	—	—	1.5	—	k Ω
Input Return Loss High Gain Bypass	S11	— —	-7.6 -11	-6.2 -9	dB
Gain High Gain Bypass	S21	17.2 -6.7	18.2 -5.7	— —	dB
Reverse Isolation High Gain Bypass	S12	— —	-27.7 -5.7	-26.7 -4.7	dB
Output Return Loss High Gain Bypass	S22	— —	-12.5 -25	-10 -20	dB

4 Printed Circuit Board and Bills of Materials

Figure 9 is the drawing of the printed circuit board. Figure 11 and Figure 12 are drawings of the evaluation boards used for each of the application frequency designs described in Section 3. These drawings show the boards with the circuit matching components placed and identified.

The Bill of Materials for the application frequency circuit boards is listed in Table 8 and Table 9. The value, case size, manufacturer and circuit function of each component is shown.

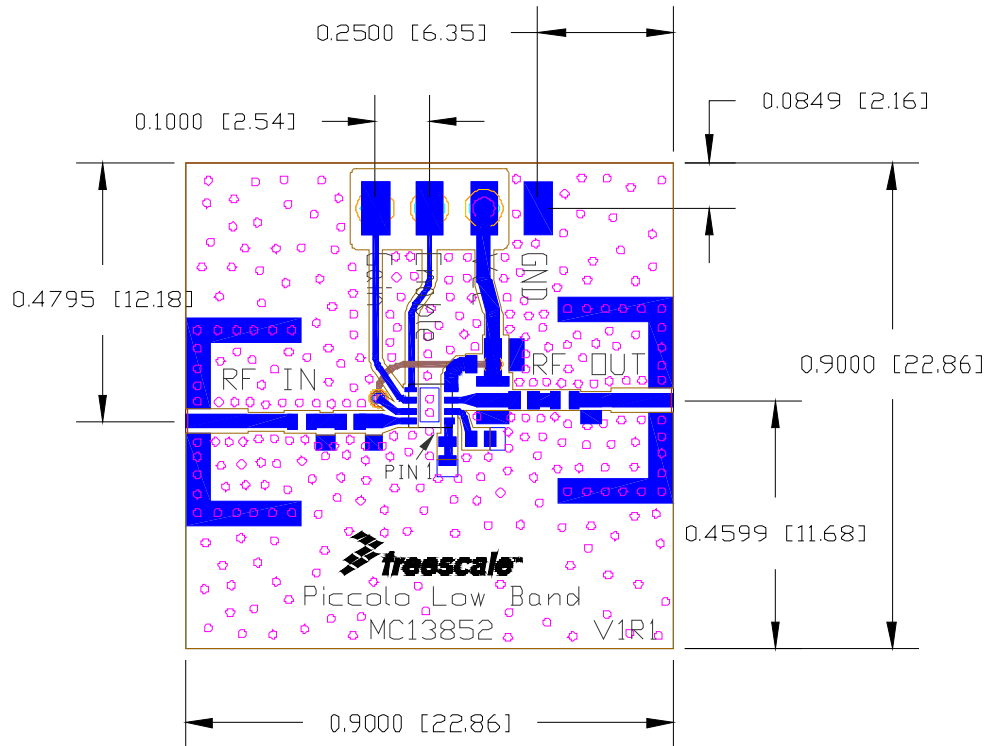

Note: Dimensions are in inches and [mm].

Soldering Note: The center flag under the part must be soldered down to ground on the board.

Figure 9. Printed Circuit Board

Figure 10 is a picture of a typical assembled evaluation board similar to the ones in the evaluation kits.

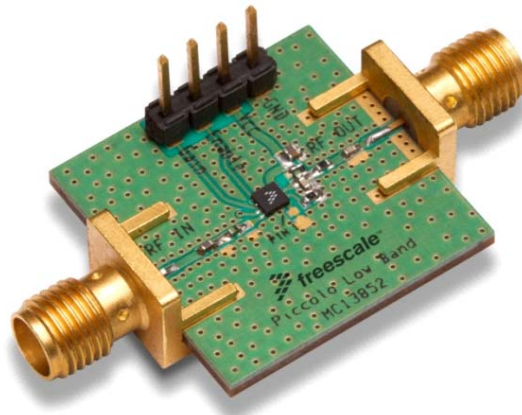

Figure 10. Typical Assembled Evaluation Board with SMA Connectors

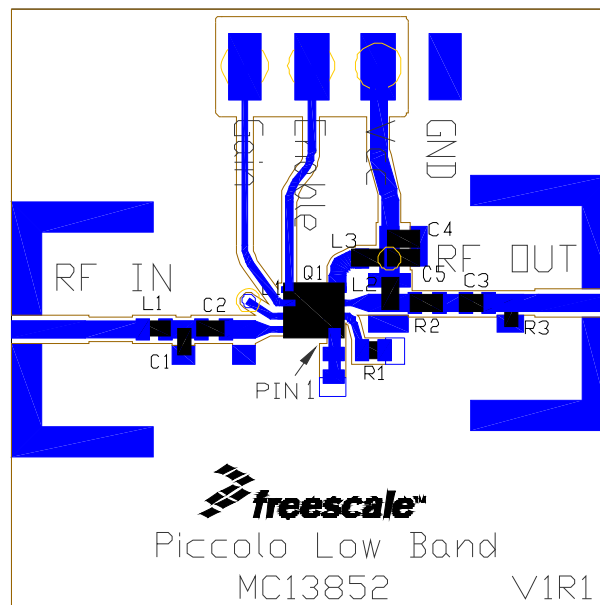

Figure 11. 434 MHz Application Board

Table 8. Bill of Materials for 434 MHz Application Board

Component	Value	Case	Manufacturer	Comments
C1	1.3 pF	402	Murata	DC block, input match
C2	47 pF	402	Murata	DC block, input match
C3	22 pF	402	Murata	Output match
C4	0.1 uF	402	Murata	Low frequency bypass
C5	33 pF	402	Murata	RF bypass

Table 8. Bill of Materials for 434 MHz Application Board (continued)

Component	Value	Case	Manufacturer	Comments
L1	27 nH	402	Murata	Input match
L2	47 nH	402	Murata	Output match, bias decouple
L3	270 nH	402	Murata	Bias couple to logic
R1	1.2 k Ω	402	KOA	Bias set point
R2	30 Ω	402	KOA	Stability, lower gain
R3	82 Ω	402	KOA	L2 de-Q, gain adjust
Q1	MC13852	MLP 2x2	Freescale	SiGe LNA

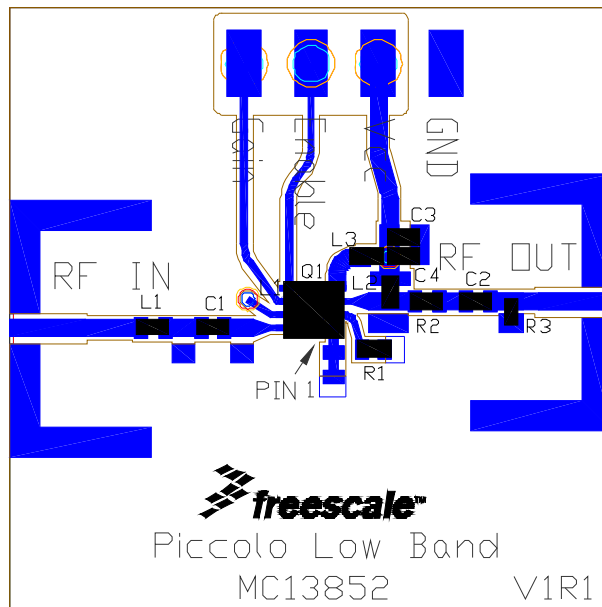

Figure 12. 900 MHz Application Board

Table 9. Bill of Materials for 900 MHz Application Board

Component	Value	Case	Manufacturer	Comments
C1	3.9 pF	402	Murata	Input match
C2	2.4 pF	402	Murata	Output match
C3	0.1 μ F	402	Murata	Low frequency bypass
C4	33 pF	402	Murata	RF bypass
L1	12 nH	402	Murata	Input match
L2	10 nH	402	Murata	Output match

Table 9. Bill of Materials for 900 MHz Application Board (continued)

Component	Value	Case	Manufacturer	Comments
L3	270 nH	402	Murata	Bias couple to logic
R1	1.2 k Ω	402	KOA	LNA bias
R2	20 Ω	402	KOA	Stability, lower gain
R3	200 Ω	402	KOA	De-Q L2, adjust gain, RLs
Q1	MC13852	MLP 2x2	Freescale	SiGe LNA

5 Scattering and Noise Parameters

Table 10 through Table 13 list the S parameters for the packaged part in a 50 Ω system for each of the modes of operation and for two values of the external bias resistor.

**Table 10. Scattering Parameters, Active Mode, R_{bias} = 1.2 k Ω
(V_{cc} = 2.75V, 25°C, 50 Ω system)**

f (MHz)	S11		S21		S12		S22	
	Mag	Ang	Mag	Ang	Mag	Ang	Mag	Ang
300	0.842	-6.5	14.329	149.3	0.013	88.9	0.952	-2.0
350	0.821	-7.5	13.624	146.1	0.015	89.9	0.939	-2.0
400	0.801	-8.1	12.975	143.0	0.017	90.0	0.927	-1.9
450	0.779	-8.6	12.343	140.3	0.019	90.2	0.915	-1.8
500	0.739	-11.2	11.895	136.6	0.021	89.5	0.909	1.5
550	0.728	-11.9	11.296	134.4	0.024	90.1	0.891	2.4
600	0.710	-12.2	10.764	132.4	0.025	90.3	0.882	3.1
650	0.691	-12.3	10.269	130.4	0.028	91.1	0.874	3.6
700	0.677	-12.1	9.820	129.0	0.030	91.4	0.863	4.3
750	0.662	-12.0	9.403	127.4	0.031	92.4	0.856	4.9
800	0.649	-12.1	8.955	126.3	0.033	92.9	0.849	5.8
850	0.636	-12.6	8.605	125.0	0.036	93.2	0.842	6.5
900	0.623	-11.8	8.263	123.9	0.037	93.7	0.832	7.0
950	0.610	-11.5	7.937	122.9	0.039	94.2	0.827	7.5
1000	0.599	-11.4	7.637	121.9	0.041	94.9	0.820	8.2
1050	0.588	-10.8	7.359	121.1	0.044	95.4	0.813	8.5
1100	0.576	-10.9	7.100	120.3	0.046	95.8	0.808	9.3
1150	0.565	-10.2	6.857	119.7	0.048	96.2	0.800	9.5
1200	0.554	-10.0	6.642	118.7	0.050	96.5	0.794	9.8

**Table 11. Scattering Parameters, Active Mode, R_{bias} = 1.5 k Ω
(V_{cc} = 2.75V, 25°C, 50 Ω system)**

f (MHz)	S11		S21		S12		S22	
	Mag	Ang	Mag	Ang	Mag	Ang	Mag	Ang
300	0.877	-5.4	11.365	155.1	0.013	89.7	0.972	-1.0
350	0.860	-6.3	10.935	152.4	0.015	90.0	0.963	-1.0
400	0.843	-7.0	10.523	149.8	0.017	90.5	0.953	-0.9

Table 11. Scattering Parameters, Active Mode, R_{bias} = 1.5 k Ω (continued)
 (V_{cc} = 2.75V, 25°C, 50 Ω system)

f (MHz)	S11		S21		S12		S22	
	Mag	Ang	Mag	Ang	Mag	Ang	Mag	Ang
450	0.825	-7.6	10.136	147.5	0.020	90.8	0.944	-0.9
500	0.788	-10.4	9.908	144.0	0.022	89.8	0.943	2.2
550	0.777	-11.2	9.493	141.9	0.024	90.0	0.926	3.0
600	0.761	-11.8	9.128	139.9	0.026	90.5	0.918	3.6
650	0.743	-12.1	8.795	138.1	0.028	90.8	0.911	4.0
700	0.730	-12.1	8.513	136.7	0.030	91.2	0.901	4.4
750	0.713	-12.3	8.228	135.1	0.032	91.8	0.894	4.9
800	0.699	-12.6	7.875	134.0	0.034	92.1	0.887	5.8
850	0.686	-13.3	7.624	132.7	0.036	92.2	0.879	6.4
900	0.670	-12.7	7.375	131.5	0.038	92.9	0.870	6.8
950	0.655	-12.6	7.125	130.3	0.040	93.6	0.864	7.4
1000	0.642	-12.5	6.885	129.2	0.042	93.7	0.856	8.0
1050	0.630	-12.1	6.667	128.3	0.044	94.3	0.849	8.3
1100	0.616	-12.2	6.457	127.4	0.046	95.0	0.845	9.1
1150	0.603	-11.7	6.264	126.7	0.048	95.6	0.838	9.4
1200	0.592	-11.5	6.084	125.6	0.050	95.8	0.831	9.7

Table 12. Scattering Parameters, Bypass Mode, R_{bias} = 1.2 k Ω and 1.5 k Ω

f (MHz)	S11		S21		S12		S22	
	Mag	Ang	Mag	Ang	Mag	Ang	Mag	Ang
300	0.593	-32.3	0.573	36.7	0.573	36.7	0.615	-27.7
350	0.540	-32.9	0.601	32.8	0.601	32.8	0.561	-27.6
400	0.496	-32.8	0.621	29.8	0.621	29.7	0.517	-26.8
450	0.459	-32.2	0.636	27.2	0.636	27.2	0.480	-25.6
500	0.413	-33.1	0.648	24.3	0.648	24.3	0.451	-20.2
550	0.391	-32.5	0.656	22.6	0.656	22.6	0.424	-17.7
600	0.368	-31.5	0.663	21.2	0.663	21.2	0.403	-15.3
650	0.348	-30.2	0.668	20.0	0.668	20.0	0.387	-13.1
700	0.333	-28.9	0.672	19.0	0.672	19.0	0.373	-10.8
750	0.318	-27.7	0.675	18.2	0.675	18.2	0.363	-8.4

Table 12. Scattering Parameters, Bypass Mode, R_{bias} = 1.2 kΩ and 1.5 kΩ (continued)

f (MHz)	S11		S21		S12		S22	
	Mag	Ang	Mag	Ang	Mag	Ang	Mag	Ang
800	0.305	-26.7	0.678	17.4	0.678	17.4	0.353	-5.9
850	0.292	-25.8	0.68	16.8	0.679	16.7	0.345	-3.4
900	0.282	-24.4	0.682	16.2	0.682	16.2	0.337	-1.3
950	0.272	-23.2	0.683	15.8	0.683	15.7	0.332	0.6
1000	0.263	-22.3	0.685	15.3	0.684	15.3	0.327	2.8
1050	0.256	-21.1	0.685	15.0	0.685	15.0	0.323	4.5
1100	0.247	-20.3	0.686	14.6	0.686	14.6	0.320	6.5
1150	0.239	-19.2	0.687	14.3	0.687	14.3	0.316	8.1
1200	0.231	-18.4	0.688	14.1	0.688	14.1	0.314	9.5

**Table 13. Scattering Parameters, Standby Mode, R_{bias} = 1.2 kΩ and 1.5 kΩ
(V_{cc} = 2.75V, 25°C, 50 Ω system)**

f (MHz)	S11		S21		S12		S22	
	Mag	Ang	Mag	Ang	Mag	Ang	Mag	Ang
300	0.974	-0.3	0.013	95.0	0.014	94.8	0.996	3.5
350	0.973	-0.2	0.016	95.5	0.016	95.1	0.994	4.1
400	0.972	-0.2	0.018	96.2	0.018	95.5	0.993	4.7
450	0.971	-0.1	0.020	96.7	0.021	96.5	0.992	5.2
500	0.956	-2.7	0.023	95.1	0.023	95.1	1.007	8.5
550	0.960	-3.2	0.026	95.8	0.026	96.0	0.999	9.6
600	0.958	-3.6	0.028	96.2	0.028	95.9	1.000	10.4
650	0.953	-3.7	0.031	96.7	0.031	96.6	1.001	11.0
700	0.952	-3.9	0.033	97.1	0.033	97.0	0.997	11.7
750	0.949	-4.1	0.036	97.5	0.036	97.5	0.998	12.4
800	0.946	-4.6	0.039	97.7	0.039	97.7	0.998	13.2
850	0.940	-5.2	0.041	98.1	0.041	97.9	0.998	14.0
900	0.941	-5.1	0.044	98.3	0.044	98.2	0.994	14.5
950	0.937	-5.3	0.047	98.8	0.047	98.8	0.994	15.0
1000	0.934	-5.7	0.049	98.9	0.049	98.8	0.993	15.6

Table 13. Scattering Parameters, Standby Mode, R_{bias} = 1.2 k Ω and 1.5 k Ω (continued)
(V_{cc} = 2.75V, 25°C, 50 Ω system)

f (MHz)	S11		S21		S12		S22	
	Mag	Ang	Mag	Ang	Mag	Ang	Mag	Ang
1050	0.931	-5.8	0.052	99.2	0.052	99.1	0.992	15.9
1100	0.925	-6.3	0.055	99.3	0.055	99.3	0.993	16.6
1150	0.923	-6.4	0.058	99.6	0.058	99.6	0.990	16.9
1200	0.919	-6.7	0.061	99.7	0.061	99.6	0.989	17.2

Table 14 and Table 15 list the noise parameters for the packaged part, as measured in a 50 Ω system for active mode operation for two values of the external bias resistor.

Table 14. Active Mode Noise Parameters, R_{bias} = 1.2 k Ω
(V_{cc} = 2.75V, 25°C, 50 Ω System, I_{cc} = 4.8 mA)

Freq	Fmin	Gamma Opt		Rn	Ga
MHz	dB	Mag	Angle		dB
400	0.94	0.244	4.2	10.0	30.86
450	0.92	0.261	1.5	10.0	29.62
500	0.90	0.273	-0.5	10.0	28.51
700	0.86	0.289	-4.2	10.0	25.18
800	0.85	0.283	-4.6	9.5	23.99
900	0.84	0.274	-4.9	9.5	22.99
1000	0.85	0.265	-5.8	9.5	22.09
1200	0.88	0.262	-12.3	9.5	20.16

Table 15. Active Mode Noise Parameters, R_{bias} = 1.5 k Ω
(V_{cc} = 2.75V, 25°C, 50 Ω System, I_{cc} = 3.8 mA)

Freq	Fmin	Gamma Opt		Rn	Ga
MHz	dB	Mag	Angle		dB
400	0.82	0.313	0.23	10.5	30.82
450	0.83	0.323	0.5	10.5	29.52
500	0.85	0.331	-1.0	10.5	28.37
700	0.90	0.337	-4.3	10.5	24.94
800	0.92	0.331	-5.0	10.5	23.75
900	0.94	0.322	-5.7	10.5	22.76

**Table 15. Active Mode Noise Parameters, $R_{bias} = 1.5\text{ k}\Omega$
($V_{cc} = 2.75\text{V}$, 25°C , 50Ω System, $I_{cc} = 3.8\text{ mA}$)**

1000	0.95	0.313	-6.8	10.5	21.87
1200	0.96	0.304	-11.7	10.5	19.94

Figure 13 through Figure 16 are the constant noise figure and gain circles with input and output stability regions shown on Smith charts. Γ_{opt} , noise resistance and stability at the frequency are shown for two values of the external bias resistor at 450, 700, 900 and 1000 MHz.

Rbias = 1.2 kΩ

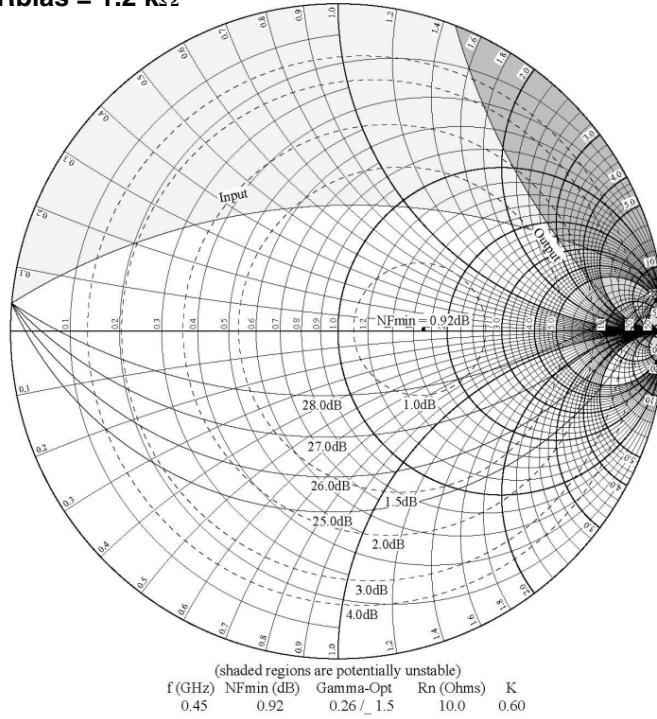

Rbias = 1.5 kΩ

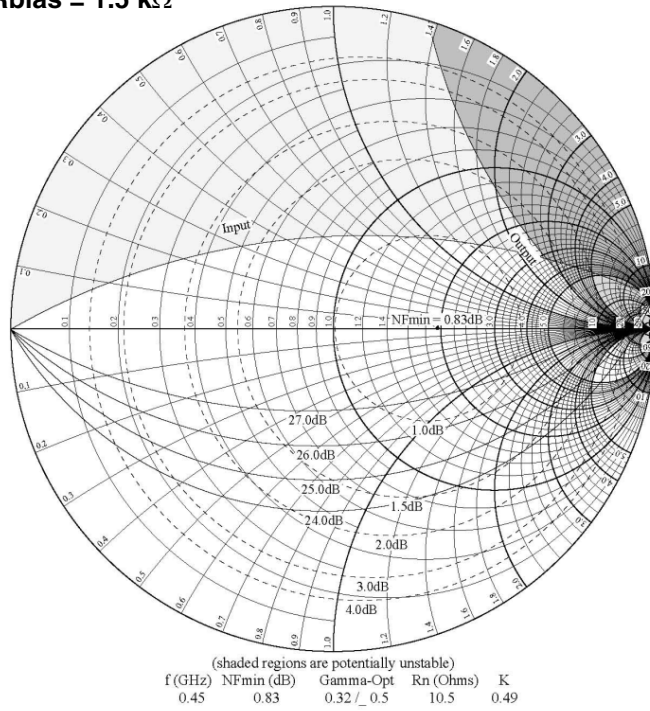
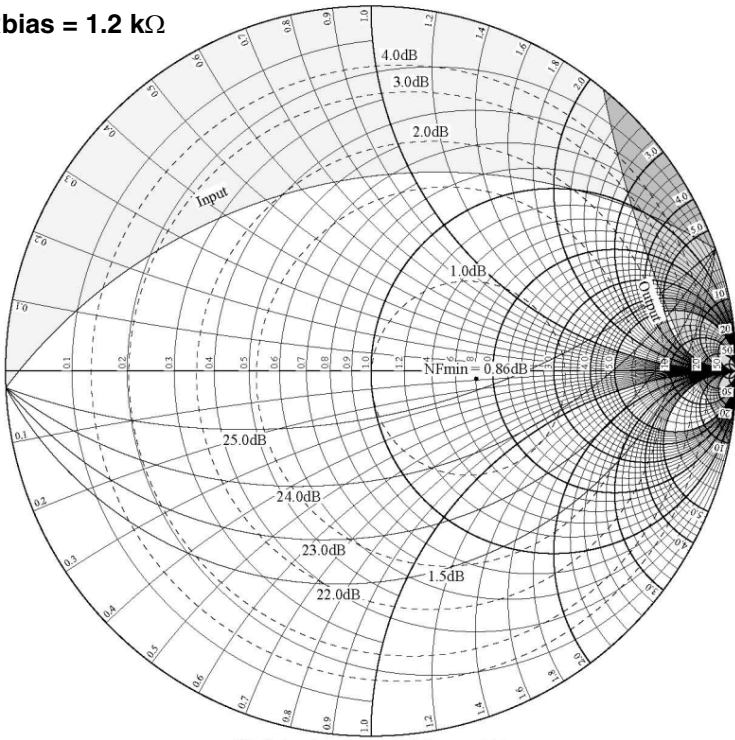

Figure 13. Constant Noise Figure and Gain Circles, 450 MHz

Rbias = 1.2 kΩ



(shaded regions are potentially unstable)
 f (GHz) NFmin (dB) Gamma-Opt Rn (Ohms) K
 0.7 0.86 0.29 / -4.2 10.0 0.77

Rbias = 1.5 kΩ

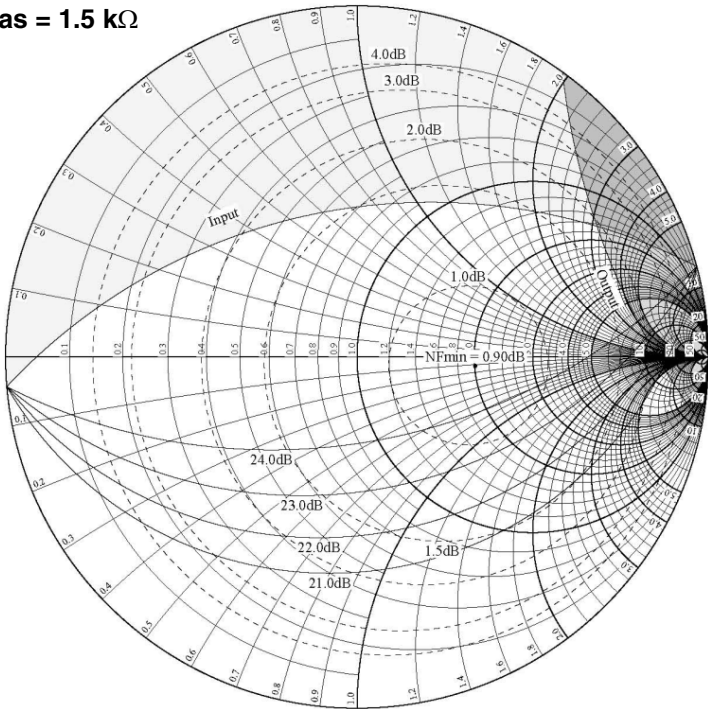

(shaded regions are potentially unstable)
 f (GHz) NFmin (dB) Gamma-Opt Rn (Ohms) K
 0.7 0.90 0.34 / -4.3 10.5 0.67

Figure 14. Constant Noise Figure and Gain Circles, 700 MHz

R_{bias} = 1.2 kΩ

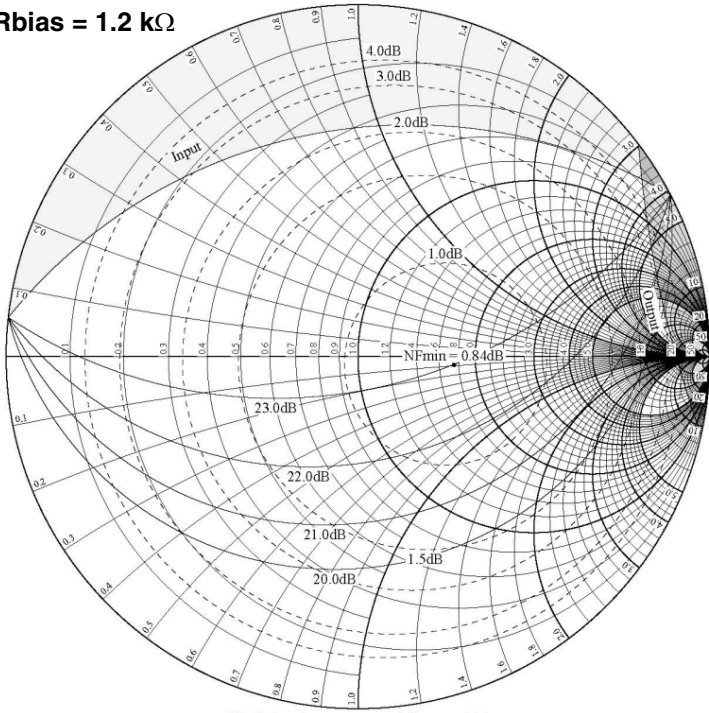

(shaded regions are potentially unstable)
 f (GHz) NFmin (dB) Gamma-Opt Rn (Ohms) K
 0.9 0.84 0.27 / -4.9 9.5 0.84

R_{bias} = 1.5 kΩ

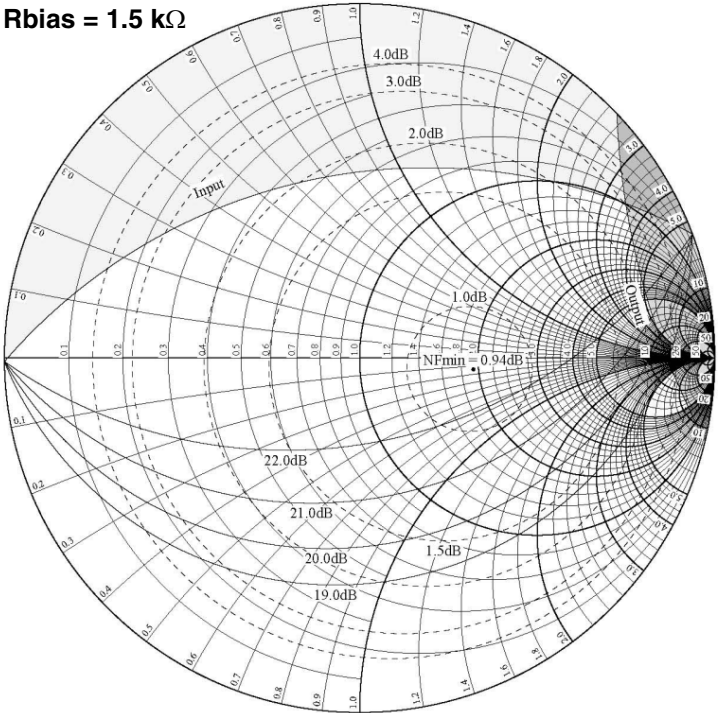

(shaded regions are potentially unstable)
 f (GHz) NFmin (dB) Gamma-Opt Rn (Ohms) K
 0.9 0.94 0.32 / -5.7 10.5 0.75

Figure 15. Constant Noise Figure and Gain Circles, 900 MHz

Rbias = 1.2 kΩ

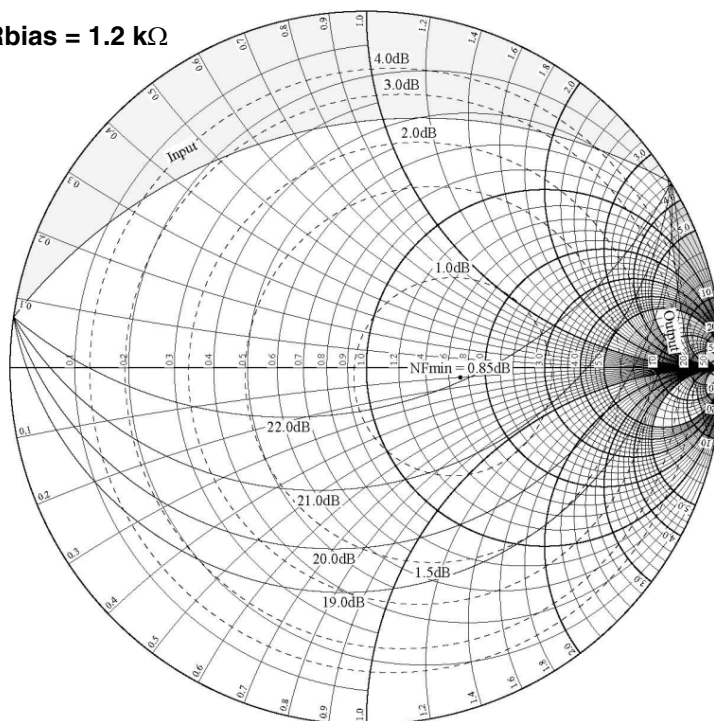

(shaded regions are potentially unstable)
 f (GHz) NFmin (dB) Gamma-Opt Rn (Ohms) K
 1.0 0.85 0.26 / -5.8 9.5 0.87

Rbias = 1.5 kΩ

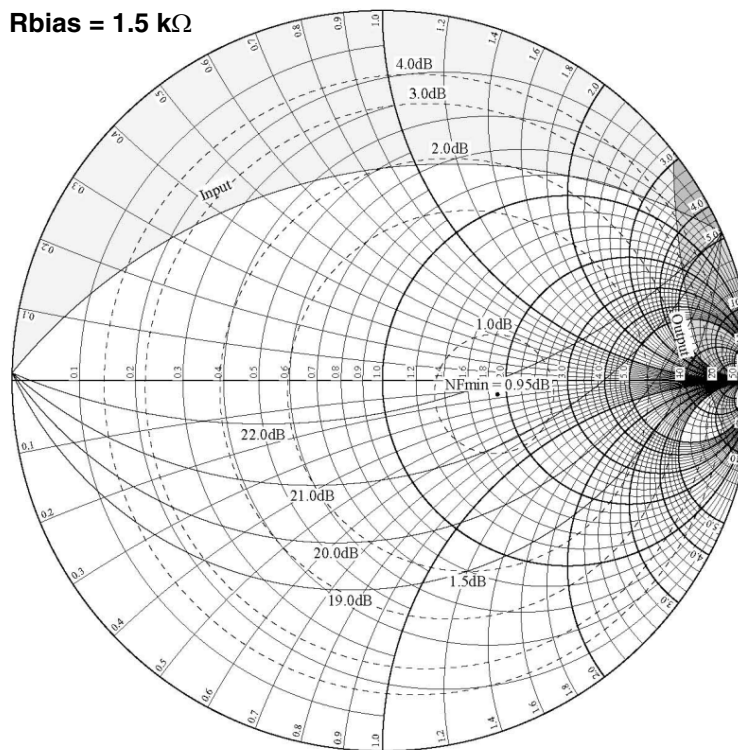

(shaded regions are potentially unstable)
 f (GHz) NFmin (dB) Gamma-Opt Rn (Ohms) K
 1.0 0.95 0.31 / -6.8 10.5 0.79

Figure 16. Constant Noise Figure and Gain Circles, 1000 MHz

6 Packaging

Figure 17 and Figure 18 are the package drawings with dimensions for the MLPD-8, $2 \times 2 \times 0.6$ mm, package.

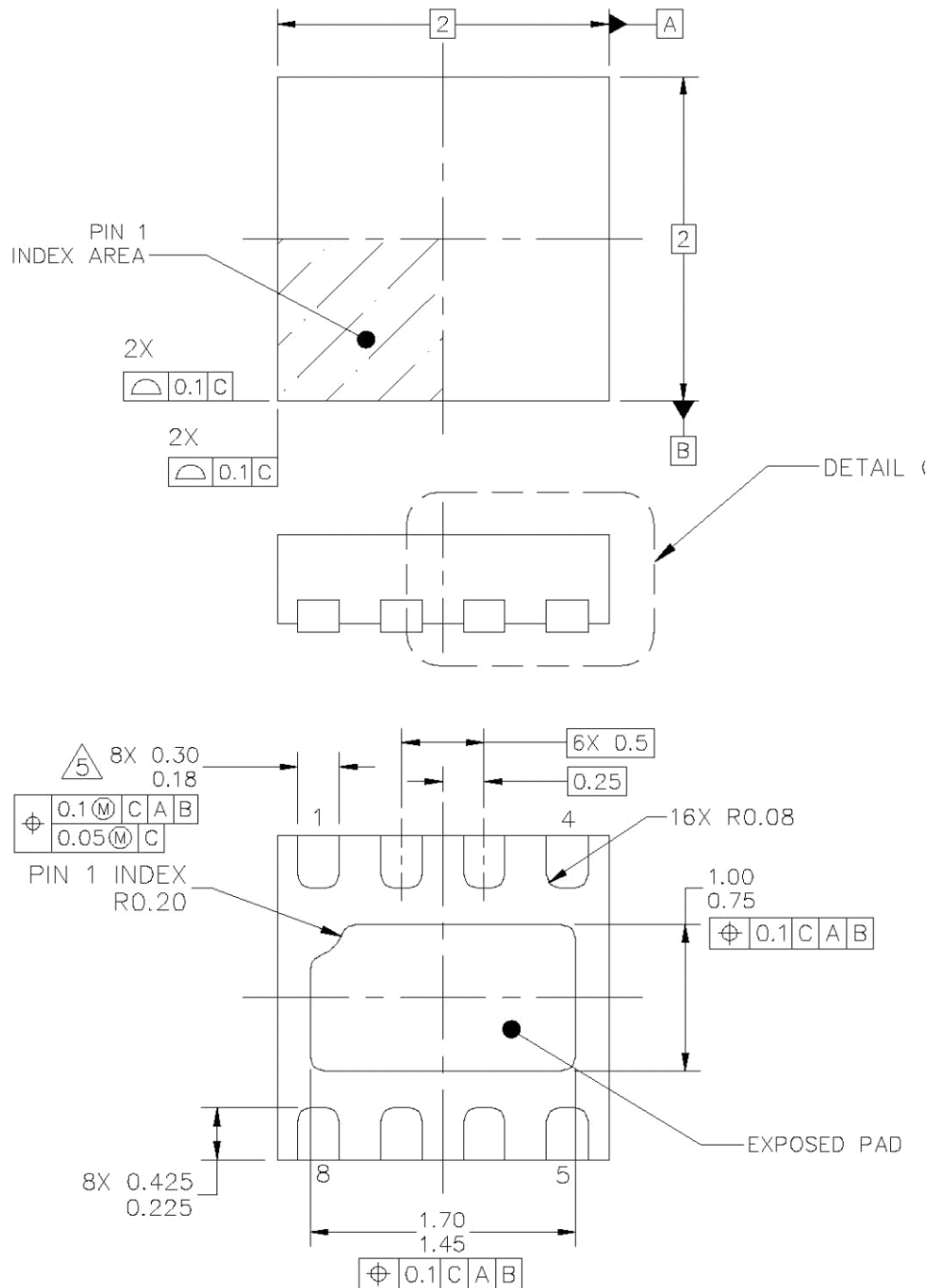
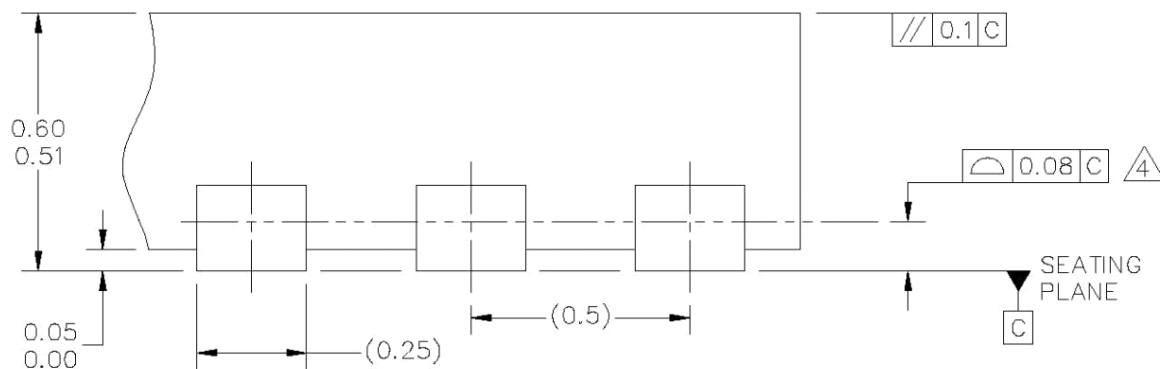

Figure 17. Outline Dimensions for MLPD-8



DETAIL G

NOTES:

1. ALL DIMENSIONS ARE IN MILLIMETERS.
2. DIMENSIONING AND TOLERANCING PER ASME Y14.5M-1994.
3. THIS IS NON JEDEC REGISTERED PACKAGE.

4. COPLANARITY APPLIES TO THE TERMINALS AND ALL OTHER BOTTOM SURFACE METALLIZATION.
5. THIS DIMENSION APPLIES TO METALLIZED TERMINAL AND IS MEASURE BETWEEN 0.15 AND 0.25 FROM THE TERMINAL TIP. IF THE TERMINAL HAS THE OPTIONAL RADIUS ON THE OTHER END OF THE TERMINAL, THIS DIMENSION SHALL NOT BE MEASURED IN THE RADIUS AREA.

Figure 18. Packaging Details

7 Product Documentation

This data sheet is labeled as a particular type: Product Preview, Advance Information, or Technical Data. Definitions of these types are available at: <http://www.freescale.com>.

8 Revision History

Table 16 summarizes revisions to this document since the last revision.

Table 16. Revision History

Revision	Description of Changes
2.0	<ul style="list-style-type: none"> • Updated entire document for changes due to increased operating frequency range (now 400–1000 MHz, was 800–1000 MHz) and increased operating ambient temperature range (now -40 to 85°C, was -30 to 85°C), and to the change in packaging from MLF8 to MLPD-8 (Section 6). • Electrical characteristics (Section 2) were updated. • New application examples (Section 3) for 434 and 900 MHz replace previous examples for 880 and 950 MHz. • For the new application examples (Section 3), printed circuit board layouts were added and bills of materials were updated (Section 4). • Scattering and noise parameters (with Smith charts for 450, 700, 900, and 1000 MHz) were added in Section 5.

How to Reach Us:

Home Page:

www.freescale.com

Web Support:

<http://www.freescale.com/support>

USA/Europe or Locations Not Listed:

Freescale Semiconductor, Inc.
Technical Information Center, EL516
2100 East Elliot Road
Tempe, Arizona 85284
1-800-521-6274 or +1-480-768-2130
www.freescale.com/support

Europe, Middle East, and Africa:

Freescale Halbleiter Deutschland GmbH
Technical Information Center
Schatzbogen 7
81829 Muenchen, Germany
+44 1296 380 456 (English)
+46 8 52200080 (English)
+49 89 92103 559 (German)
+33 1 69 35 48 48 (French)
www.freescale.com/support

Japan:

Freescale Semiconductor Japan Ltd.
Headquarters
ARCO Tower 15F
1-8-1, Shimo-Meguro, Meguro-ku,
Tokyo 153-0064
Japan
0120 191014 or +81 3 5437 9125
support.japan@freescale.com

Asia/Pacific:

Freescale Semiconductor China Ltd.
Exchange Building 23F
No. 118 Jianguo Road
Chaoyang District
Beijing 100022
China
+86 10 5879 8000
support.asia@freescale.com

For Literature Requests Only:

Freescale Semiconductor Literature Distribution Center
1-800-441-2447 or +1-303-675-2140
Fax: +1-303-675-2150
LDCForFreescaleSemiconductor@hibbertgroup.com

Information in this document is provided solely to enable system and software implementers to use Freescale Semiconductor products. There are no express or implied copyright licenses granted hereunder to design or fabricate any integrated circuits or integrated circuits based on the information in this document.

Freescale Semiconductor reserves the right to make changes without further notice to any products herein. Freescale Semiconductor makes no warranty, representation or guarantee regarding the suitability of its products for any particular purpose, nor does Freescale Semiconductor assume any liability arising out of the application or use of any product or circuit, and specifically disclaims any and all liability, including without limitation consequential or incidental damages. "Typical" parameters that may be provided in Freescale Semiconductor data sheets and/or specifications can and do vary in different applications and actual performance may vary over time. All operating parameters, including "Typicals", must be validated for each customer application by customer's technical experts. Freescale Semiconductor does not convey any license under its patent rights nor the rights of others. Freescale Semiconductor products are not designed, intended, or authorized for use as components in systems intended for surgical implant into the body, or other applications intended to support or sustain life, or for any other application in which the failure of the Freescale Semiconductor product could create a situation where personal injury or death may occur. Should Buyer purchase or use Freescale Semiconductor products for any such unintended or unauthorized application, Buyer shall indemnify and hold Freescale Semiconductor and its officers, employees, subsidiaries, affiliates, and distributors harmless against all claims, costs, damages, and expenses, and reasonable attorney fees arising out of, directly or indirectly, any claim of personal injury or death associated with such unintended or unauthorized use, even if such claim alleges that Freescale Semiconductor was negligent regarding the design or manufacture of the part.

Freescale™ and the Freescale logo are trademarks of Freescale Semiconductor, Inc. All other product or service names are the property of their respective owners.

© Freescale Semiconductor, Inc. 2006-2010. All rights reserved.

RoHS-compliant and/or Pb-free versions of Freescale products have the functionality and electrical characteristics as their non-RoHS-compliant and/or non-Pb-free counterparts. For further information, see <http://www.freescale.com> or contact your Freescale sales representative.

For information on Freescale's Environmental Products program, go to <http://www.freescale.com/epp>.

X-ON Electronics

Largest Supplier of Electrical and Electronic Components

Click to view similar products for [RF Amplifier](#) category:

Click to view products by [NXP](#) manufacturer:

Other Similar products are found below :

[A82-1](#) [BGA622H6820XTSA1](#) [BGA 728L7 E6327](#) [BGB719N7ESDE6327XTMA1](#) [HMC397-SX](#) [HMC405](#) [HMC561-SX](#) [HMC8120-SX](#)
[HMC8121-SX](#) [HMC-ALH382-SX](#) [HMC-ALH476-SX](#) [SE2433T-R](#) [SMA3101-TL-E](#) [SMA39](#) [A66-1](#) [A66-3](#) [A67-1](#) [LX5535LQ](#) [LX5540LL](#)
[MAAM02350](#) [HMC3653LP3BETR](#) [HMC549MS8GETR](#) [HMC-ALH435-SX](#) [SMA101](#) [SMA32](#) [SMA411](#) [SMA531](#) [SST12LP17E-XX8E](#)
[SST12LP19E-QX6E](#) [WPM0510A](#) [HMC5929LS6TR](#) [HMC5879LS7TR](#) [HMC1126](#) [HMC1087F10](#) [HMC1086](#) [HMC1016](#) [SMA1212](#)
[MAX2689EWS+T](#) [MAAMSS0041TR](#) [MAAM37000-A1G](#) [LTC6430AIUF-15#PBF](#) [CHA5115-QDG](#) [SMA70-2](#) [SMA4011](#) [A231](#) [HMC-](#)
[AUH232](#) [LX5511LQ](#) [LX5511LQ-TR](#) [HMC7441-SX](#) [HMC-ALH310](#)